



This is a digital copy of a book that was preserved for generations on library shelves before it was carefully scanned by Google as part of a project to make the world's books discoverable online.

It has survived long enough for the copyright to expire and the book to enter the public domain. A public domain book is one that was never subject to copyright or whose legal copyright term has expired. Whether a book is in the public domain may vary country to country. Public domain books are our gateways to the past, representing a wealth of history, culture and knowledge that's often difficult to discover.

Marks, notations and other marginalia present in the original volume will appear in this file - a reminder of this book's long journey from the publisher to a library and finally to you.

Usage guidelines

Google is proud to partner with libraries to digitize public domain materials and make them widely accessible. Public domain books belong to the public and we are merely their custodians. Nevertheless, this work is expensive, so in order to keep providing this resource, we have taken steps to prevent abuse by commercial parties, including placing technical restrictions on automated querying.

We also ask that you:

- + *Make non-commercial use of the files* We designed Google Book Search for use by individuals, and we request that you use these files for personal, non-commercial purposes.
- + *Refrain from automated querying* Do not send automated queries of any sort to Google's system: If you are conducting research on machine translation, optical character recognition or other areas where access to a large amount of text is helpful, please contact us. We encourage the use of public domain materials for these purposes and may be able to help.
- + *Maintain attribution* The Google "watermark" you see on each file is essential for informing people about this project and helping them find additional materials through Google Book Search. Please do not remove it.
- + *Keep it legal* Whatever your use, remember that you are responsible for ensuring that what you are doing is legal. Do not assume that just because we believe a book is in the public domain for users in the United States, that the work is also in the public domain for users in other countries. Whether a book is still in copyright varies from country to country, and we can't offer guidance on whether any specific use of any specific book is allowed. Please do not assume that a book's appearance in Google Book Search means it can be used in any manner anywhere in the world. Copyright infringement liability can be quite severe.

About Google Book Search

Google's mission is to organize the world's information and to make it universally accessible and useful. Google Book Search helps readers discover the world's books while helping authors and publishers reach new audiences. You can search through the full text of this book on the web at <http://books.google.com/>

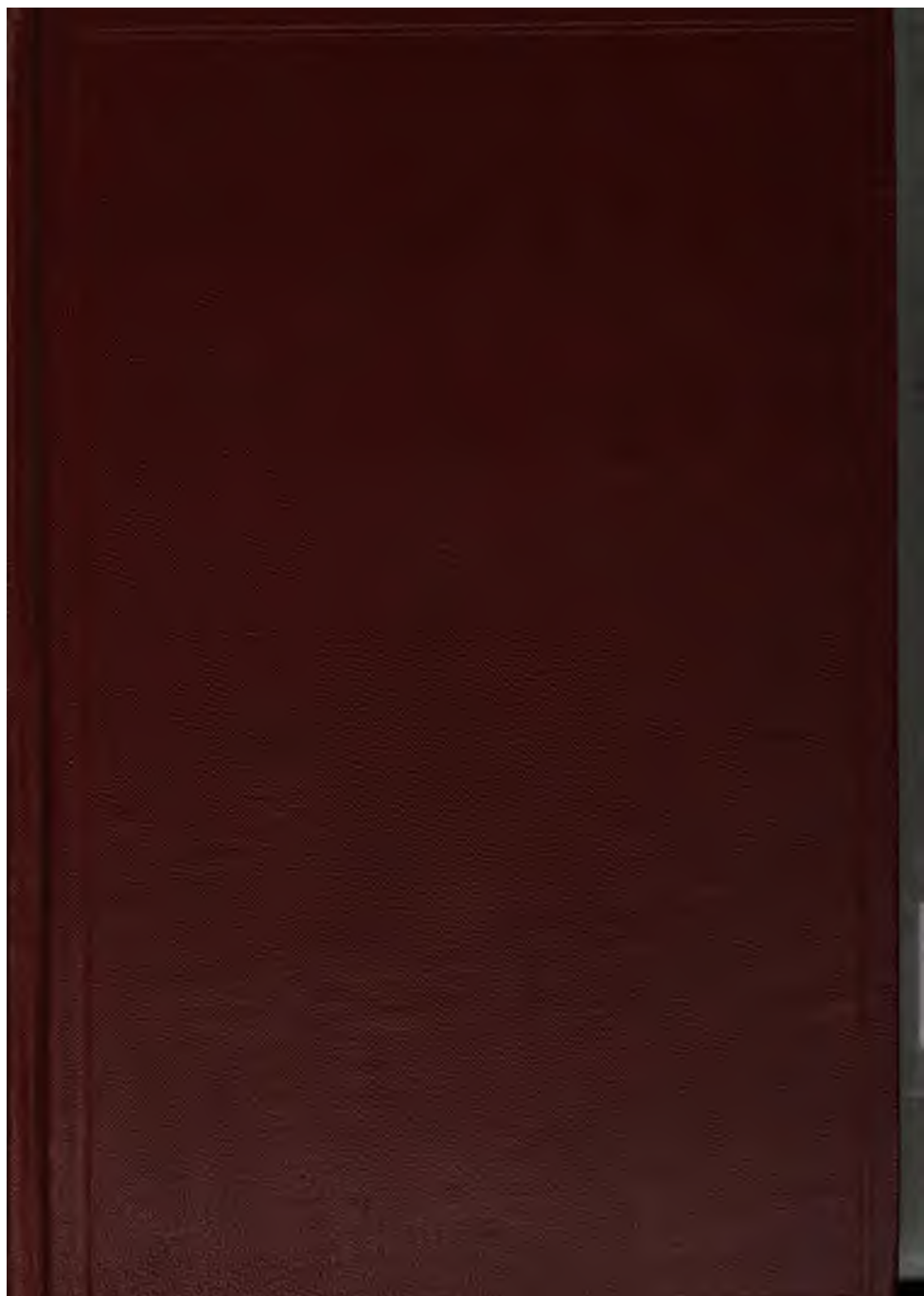

Gift of

John Branner Newsom



STANFORD UNIVERSITY LIBRARIES

Property of

O. B. Perry

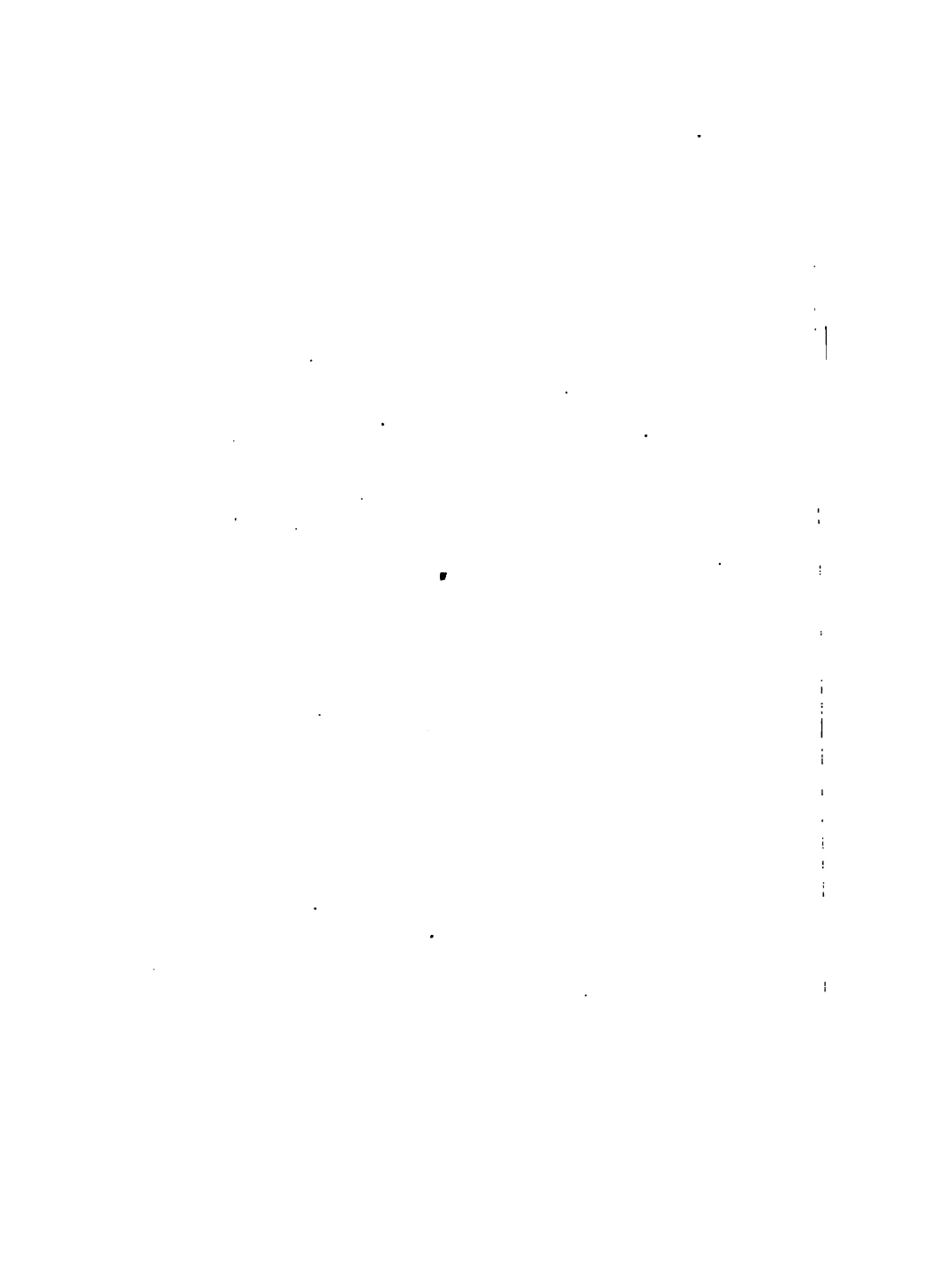

WORKS OF HALBERT P. GILLETTE

Handbook of Cost Data

A reference book giving methods of construction and actual costs of material and labor on all kinds of engineering works. 1900 pages. 16 mo., flexible binding, 4 $\frac{3}{4}$ x 7. \$5.00

Handbook of Rock Excavation

A practical treatise on drilling, excavating, quarrying and handling rock. 809 pages, 200 illustrations, flexible binding, 4 $\frac{3}{4}$ x 7. \$5.00

Handbook of Earth Excavation

A practical treatise on the excavation and handling of earth. Over 800 pages, illustrated, flexible binding, 4 $\frac{3}{4}$ x 7. \$5.00

JOINT AUTHOR WORKS

Cost Keeping and Management Engineering

By Halbert P. Gillette and Richard T. Dana

A treatise for civil engineers and contractors. 360 pages, 184 figures, 5 x 8. \$3.50

Concrete Construction, Methods and Cost

By Halbert P. Gillette and Chas. S. Hill

A treatise on concrete and reinforced concrete structures of every kind. 700 pages, 306 figures, 6 x 9. Cloth. \$5.00

HANDBOOK
OF
ROCK EXCAVATION
METHODS AND COST

BY
HALBERT POWERS GILLETTE

*Managing Editor of Engineering and Contracting, Member American Society
of Civil Engineers, Member American Society of Engineering
Contractors, Member American Institute of Mining
Engineers, Member Society for the
Promotion of Engineering
Education*

ILLUSTRATED

NEW YORK
CLARK BOOK COMPANY, Inc.
1916

COPYRIGHT 1916
BY
CLARK BOOK COMPANY, Inc.

PREFACE

The purpose of this book is to place in the hands of those who are interested in the economic handling of rock, in most convenient form, the bulk of the material that was published twelve years ago under the title of "Rock Excavation, Methods and Cost," together with twice as much more material which I have since collected.

The subject of "Rock Excavation" is in itself so broad and has become so highly specialized in its methods and in the machinery that has been developed for carrying it on, as to require for its adequate treatment at least one volume and a large one at that. Rock excavation is related closely to earth excavation. I have found in working at my notes that a large amount of valuable material pertaining strictly to "Earth Excavation" has accumulated. This earth material will be published as a companion volume to the one on "Rock" and is now practically ready for the printer. A third handbook on the subject of "Tunnels and Shafts" is likewise in preparation and will be ready soon.

It has been decided to adopt the handbook size and style for these books as I have found in my own practice that a small book in flexible binding that can be easily carried in the pocket, or conveniently carried in a traveling grip, has practical advantages which make it a good deal more useful than the larger, stiff-covered bindings that have come to be associated particularly with text-books.

Although not put up in a characteristically text-book binding, it is believed that this volume will be useful as a text, for although there is no general quantitative theory of excavation, the subject is susceptible of scientific treatment. The first step to that end is the orderly collocation of a large variety of data relating to the cost of work done under a variety of conditions with a description of the methods whereby the work was done and the costs incurred. A necessary part of that first step is the expression of the results in the form of unit costs, which are an essential and most convenient index to any final judgment of the effectiveness of a tool or a method of excavation. Accordingly I have been at considerable pains to gather numerous cost data into unit form on this subject, and while in some of the cases cited the details are not so complete as I could

wish, I have thought it best not to exclude any reliable record of actual costs merely because some items were lacking, especially if those items could be supplied through the natural deductions of the experienced and competent reader. For each class of rock excavation I give several examples that are complete as to the items of unit cost, and these examples will serve as standards by which to gage the completeness of the others and as a guide to the reader in readily supplying any omissions.

The reader will find an exceptionally large number of methods of excavating and transporting rock under different conditions in addition to a great many examples of actual costs given in detail. The tools and machines required for rock work have been described and illustrated in greater variety than hitherto. The six chapters devoted to drills and drilling alone would make a volume of considerable size. The chapters on cable and other well drills and on diamond and other core drills present more complete information on these subjects than can be found in any other book within my knowledge.

In fact, I think the same may be said of every other chapter, except perhaps the first, on rocks, the sixth, on power plants, and the eighteenth, on subaqueous excavation. While there are other and most excellent books treating on the subject of blasting, I think it will be found that this one in its various chapters covers it more comprehensively, at least from the blaster's point of view, than any other work, and particularly does this seem true of the data on "chamber blasting" which has proved so effective in many large operations that I have thought it advisable to give an abstract of most of the published facts on the subject.

In the final arrangement of my notes for this book I have prepared a large and quite complete bibliography on each phase of the subject, but as the subject matter is now so voluminous as to pass the limits of a handbook of reasonable size, I have thought it best to exclude the bibliography for want of space.

For assistance in editorial work in preparing many of the original articles for the columns of *Engineering and Contracting* I wish to acknowledge my indebtedness to Messrs. Charles S. Hill, C. T. Murray, D. J. Hauer, and H. B. Kirkland. Mr. H. C. Lyons effectively aided in abstracting articles, papers, and other information for this book.

HALBERT P. GILLETTE.

15 William Street,
New York City.
July 3, 1916.

TABLE OF CONTENTS

CHAPTER	PAGE
<p>I ROCKS AND THEIR PROPERTIES</p> <p>Rock forming minerals, 1; Hardness, 2; Rock species, 3; Igneous, aqueous, and metamorphic rocks, 4; Joints, 4; Veins and beds, 5; General names, 5; Quarrymen's terms, 6; Planes of cleavage, 6; Granite, Gneiss, Porphyry, Lisparite, Syenite, and Trap, 7; Diabase, Gabbro, Norite, Basalt, Diorite, Andesite, and Sandstone, 8; Quartzite, Slate and Shale, 9; Limestone, Weights and Voids, 10; Specific Gravity, 11; Tables of Weights of Rock, 12; Voids in rock blasted under water, Weight affected by moisture, 13; Measurement of rock, 14; Riprap, Settlement of crushed stone, Overbreakage, 15; Classification of excavated materials in specifications, 17.</p>	1
<p>II METHODS AND COST OF HAND DRILLING</p> <p>Kinds of hand drills, Theory of drilling, 21; Effect of size of hole, 22; Effect of inclination of hole, 23; Hammer drilling, One hand vs. two hand drilling, 24; Churn drilling, 25; Cost of hammer drilling, 26; Cost of hand drilling in granite, 28; Cost of hand drilling in gneiss, 29; Cost of hand drilling in mica schist, 30; Comparative cost of hand and machine drilling in tunneling, 31; Speed of hand drilling in railroad work, 32; Comparative cost of hand and machine drilling in mining, 33; Table of speeds of hand hammer drilling, Cost of churn drilling, 34; Augers boring blast holes in hard clay and soft rock, 35; Trimming the side of a rock excavation, 36.</p>	21
<p>III DRILL BITS: SHAPE, SHARPENING AND TEMPERING</p> <p>Hand drill bits, 37; Machine drill bits, 39; Drill bits in South Africa, 43; Bits for removing cuttings, 44; Drill bit with lugs, Removal of sludge, Derby tubular drill bit, 45; Air hammer drill bits, 46; Shapes of pneumatic hammer bits, 47; Table of shapes of air hammer drill bits and relative drilling speeds, Size of percussive drill bits, 49; Sharpening hand drill bits, 50; Table of weights per foot of solid and hollow drill steels, 51; Grades of steel, Sharpening machine drill bits, 53; Cooling bath, 54; Cost of sharpening bits by hand, Machine or power sharpening, 56; Fuel for forges, 59; Cost of fuel for forges, 60; Making charcoal for fuel, 61; Cost of blacksmith shop equipment, Hollow steel for special conditions, 62; Blunt steel, 64; Carr bits, 66.</p>	37
<p>IV MACHINE DRILLS AND THEIR USE</p> <p>Types of power drills, 68; Recent development in rock drill design and construction, 69; Modern rock drill, 71; Hammer</p>	68

type of drill, 74; Table of percussive air and steam drills, 77; Parts of a percussive drill, 78; Illustrations of various drills, 79, 80, 81, 82; Types of valves, 83; Rotation systems, Size of steam or air drills, 84; Size of percussive drills, 85; Table of tappet valve drills, 86-87; Table of Corliss valve drills, Table of air valve drills, 89, 90, 91, 92, 93, 94; Butterfly rock drill, 95; Drill mountings, 96; Handling a percussive drill on a tripod, 98; Use of column or bar, 103; Air hammer drills, 105; Table of unmounted air hammer drills, (107-112); Table of air feed or cradle mounted hammer drills, (113-118); Comparative worth of hammer and percussive drills, 119; handling a hammer drill, 120; Hammer drill mountings, 121; Handling drills in shaft sinking, 122; Water jets in drilling, 123; Rule for determining the amount of water to use in jet, 124; Rules for drill jets, 129; Other data about the water jet, 130; Chart showing amount of water to use in water jets, 131; Combined water and air jets, 132; Sullivan Water Reciprocating Drill, 133; Butterfly drill with water spray, 134; Water spray, Dust collectors, Air jet, 135; Leyner-Ingersoll drill, Comparative test of large and small Leyner drills, 136; Sullivan mounted type of hammer drill, Use of collar pipe in drilling, 138; Sectional view of a No. 18 Leyner-Ingersoll Drill, 139; Sludge agitator, or air wash-out, Sludge pump, 140; Jammed drill extractor, Auto-traction rock drill, 141; Pump steels for cleaning holes of sludge, 143; Deep hole wagon drilling rigs, 145; Auto-traction drill rig and hollow piston drill, Brandt rotary drill, 147; Electric drills, 148; Electric Solenoid drill, Percussive and hammer electric drills, 149; Electric-Air Pulsator drill, 151; Gasoline air drill, Pneumelectric drill, 153; Gasoline rock drill, 155; Rice gasoline rock drill, 158.

V COST OF MACHINE DRILLING 160

Cost factors, 160; Percentage of time lost in percussive drilling, 161; Time studies of percussive drilling, 163; Average time drilling vertical holes, 164; Rates of drilling in different rocks, Average time drilling holes in a breast, 165; Timing drilling processes, 166; Approximate determination of air pressure at drills, 168; Time of drilling operations on nine jobs, 169; Drilling contest in Colorado, 170; Drifting contest in Arizona, 171; Year's drill work in a Pennsylvania quarry, 172; Two months' drill work in Oklahoma quarry, 173; Transvaal stope competition, 174; Estimating feet drilled per shift, 177; Average footage drilled per shift, 179; Daily cost of operating percussive drill plants, 179; Cost of sharpening bits, 183; Cost of percussive drill repairs and renewals, 184; Cost of percussive drill repairs in Washington tunnel work, 185; Cost of repairing air hammer drills and percussive drills, 187; African contest between air hammer and percussive drills, 188; Test of air hammer drill, 191; Comparative speed of hand churn and air hammer drilling, 192;

TABLE OF CONTENTS

CHAPTER	PAGE
<p>Cost of air hammer drilling with portable gasoline driven compressors, 193; Air hammer drills in New York, 194; Cost of drilling with electric drills, 195; Cost of operating and maintaining electric air drills, 199; Speed of drilling with electric air drills, 203; Electric air drill wagon, Drilling with the pneumelectric drill, 204; Speed of auger boring machines, 205; "Hole Contract" system of reducing drilling costs, 206; Cost keeping, Testing drill efficiency at North Star Mines, Cal., 207.</p>	
VI STEAM, COMPRESSED AIR AND OTHER POWER PLANTS	211
<p>Efficiency of steam and compressed air plants, Heat energy and horse power, 211; Work of compression, 212; Table: brake hp. required to compress air to given pressure, 213; Table: steam volume and temperature at given pressures, Tests of air consumed by percussive drills, 214; Drilling speed for given pressures, 215; Test of a Leyner Water drill, Test of air consumption at the Rose Deep Mine, 217; Air required by drills, 218; Calculating the needed capacity of a compressor, 219; Diversity factors, 220; Air compression above sea level, Tables of air consumption in catalogues, Table: air required to run a one drill plant, 221; Effect of air pressure on drilling speed, 222; Steam consumption in terms of air consumption, 223; Efficiency of steam pipe line, Table: losses by friction and conduction in delivering steam through bare iron pipe at 75 lb. pressure, 224; Table: coverings for steam pipe, 225; Table: surface area of steam pipe for given diameters, 226; Cost of lagging steam pipe, 227; Pipe lines for transmitting compressed air, 228; Table: air line pipe, Flexible metal hose, reheating compressed air, 229; Types and sizes of re-heaters, 230; Flow of air through pipes, 231; Steam boiler efficiency, 232; Boiler capacity for steam drills, Merits of compressed air, 234; Various types of compressors, 235; Efficiency test on the Jerome Reservoir compressor plant, 236; Cost of Compressor plants and coal consumption on four jobs, Prices of air compressors, 237; Cost of installing a compressor plant, 238; Cost of Compressor plants for mines, Cost of a large compressor plant, 239; Cost of a floating compressor plant, 240; Comparison of cost of compressing with steam and electricity, 241; Water driven compressors, 243; Air compression by the action of falling water, 244; Comparative cost of compressing air by water wheel, by electric motor, and by hydraulic compressor, 246; Gasoline air compressors, 247; Small portable air compressor, 248; Prices of compressors, 249; Repairs and depreciation of power plants, 250; Cost of compressed air on Panama Canal, 251.</p>	
VII CABLE DRILLS, WELL DRILLS, AUGERS AND COST DATA	252
<p>Cable drills for blast hole work, Types of percussion well-drilling machines, 252; String of tools used with standard</p>	

TABLE OF CONTENTS

drilling outfit, 254; Pole tool method, Hollow rod method, 255; Portable well drill rigs, Price of cable drills, Advantage of traction, Method of operating well drilling machines, 256; Table: well drill data, 257; Keystone well drill, 258; Spudding, 259; String of tools, 260; Well drill bits, Speed of cable drilling, 261; cable drill bits and tools, 262; Table: Speed of drilling with cable or well drills, 263; Advantages of cable or well drills in blast hole drilling, 265; Cost of operating cable drills, Cost on Pennsylvania R. R. work, 266; Comparative speeds in the Enola yards of the Pennsylvania R. R. Co., 267; Comparison of cost of cable and tripod percussive drilling, 268; Cost of cable drilling in quarry work in Ohio, Rate of drilling in basaltic rocks, 269; Record of drilling in a limestone quarry, Cost of cable drilling in mining copper ore, 270; Cost of cable drilling in Westchester County, N. Y., Use of well drilling machines, 271; Value of drill holes in prospecting, Cost of cable drilling in prospecting, 272; Cost of prospect drilling in Nevada and Missouri, 275; Cost of prospect drilling in Montana, Cost of prospect drilling in New Mexico and Arizona, 277; Costs and records of prospecting in Silverbell, Arizona, 278; Cost of drilling with well drilling machines in ore prospecting, Ludlow, California, 279; Prospecting for Miami Copper Co., Arizona, 281, 284; Drilling 57 prospect holes with well drilling machines, 284; Table: speed of cable drilling, 285; Table: cost of drilling in New Mexico, 289; Time table of 20 months' drilling, Scale of wages, Cost of artesian well, Cable drilling and prospecting, further data on the Miami District work, 290; Rotary auger drills, Driving an oil well with a rotary rig at Dallas, Texas, 297; Cementing casing, 300; Improved methods of deep cable drilling in California, 303; Temper screw for rotary outfit, 307; Hydraulic elevator for moving casing, 309; Rotary well drill, 310; Sharp & Hughes cone bit, 311; Complete rotary drilling outfit, 315; Comparative costs of rotary and cable drilling, 317; Cost of rotary and cable drilling in California, (319-325).

VIII CORE DRILLS

Core drilling, Diamond drills, 326; Sizes of cores, 327; Diamonds, Prices of Diamonds, 328; Table: Price of diamonds per carat, Carbons required, 329; Notes on diamond setting, 330; Diamond consumption, 331; Cost using carbons vs. cost using borts, Adaptability of each stone, Table: Analysis of stone consumption, 332; Low cost in carbon consumption, 333; Water required, Use of air instead of water, Price of diamond drills, 334; Price of diamond drilling outfit, Derricks, Cost of moving and setting up a diamond drilling outfit, 337; Instructions for operating diamond drills, Divergence of holes from line, 338; Diamond drilling rig, 339; Spudding bits and augers, Surveying the bore hole,

TABLE OF CONTENTS

CHAPTER

vii
PAGE

Hydrofluoric acid method, 340; Electric light method, 342; Asiclinometer, 343; Section of surveying instrument, 344; Compass for determination of course of drill hole, 345; Gelatin method, Drill hole caliper, Factors affecting the rate of diamond drilling, 346; Cost in Virginia, 348; Time lost in diamond drilling operations, 349; Cost and speed of diamond drilling in Canada, 353; Cost of diamond drilling in British Columbia, 354; Cost of diamond drilling in the Colorado coal measures, 356; Table of progress in diamond drilling, 357; Cost of drilling in prospecting for coal in Greene County, Penna., 358; Cost of drilling in Lehigh Valley, Cost of drilling on Croton Aqueduct, 360; Table: cost of diamond drilling at Hibbing, Minn., 361; Cost of drilling in Michigan and Minnesota, 362; Diamond drill holes in mining in northern Minnesota, Cost of diamond drilling at Douglas Island, Alaska, 363; Contract costs of drilling in the Lake Superior copper country, Cost of hand diamond drilling in Arizona, 365; Diamond drilling on the Mesabi, Method of deep sea diamond drilling, 367; Comparative cost of drilling and wash boring on the deep sea waterways survey, N. Y., 369; Cost of drilling in New York City, 370; Cost of world's deepest diamond drill borings, 371; Brejcha system of diamond drilling, 372; Cementing process, 377; Shot drills, Shot required, 379; Sizes of shot drills, 380; Davis cutter, Double core barrel, Speed and cost of shot drilling, 381; Directions for operating shot drills, 382; Cost of drilling, New York City, 385; Use of Terry shot drill in New Jersey, 386; Use of a shot drill in prospecting for coal, 387; Cost of drilling concrete, 389; Comparison of cost of shot and diamond drilling in Nova Scotia, 389; Comparative costs of wash borings and shot drilling, 390; Table: Cost of shot Calyx drilling, 391; Shot drilling outfit, 392; Cable drilling outfit, 393; Diamond drilling and hydraulic testing of seaminess of rock, Ashokan dam site, 394.

IX EXPLOSIVES

402

Action of gases from an explosion, 402; Black powder, 404; Properties of good black powder, Dynamite and nitroglycerin, 405; Composition of dynamite, 407; Grades of dynamite, 407; Table: explosives equivalent in strength to Atlas, 408; Varieties of dynamite, Tables, straight and low freezing dynamite, 409; Tables: ammonia and gelatin dynamite, Atlas powder, Rendrock, 410; Giant Powder, Stonite, Dualin, Carbonite, Hercules, Vigorite, Horsley Powder, Gelignite, 411; Forcite, Judson Giant Powder, Vulcanite, Lithofracteur, 412; Weight of dynamite, 412; Blasting gelatin, Judson powder and contractor's powder, 413; Trojan powder, Rackarock, Mercury, fulminate, 414; Permissible explosives, Table. weight of explosives per ft. of drill hole, 415; Thawing dynamite, 418; How to thaw dynamite, 420; Storage and handling of dynamite, 423; Table: safe storage distances of dynamite from buildings, 429; Specifications for dynamite magazine,

430; Transportation of explosives, 431; Efficiency of frozen dynamite, 432; Lead block tests with 40% dynamite, Testing dynamite for safety, 433; New explosive gelatin, not easily affected by cold weather, 434; Tests of explosives, 435; Detonators and fuse, Cost of dynamite at Panama, 436.

X CHARGING AND FIRING 437

Kind of explosive to use, 437; Table: energy of explosives, 438; Table: toughness of rocks, 439; Charging black powder, 441; Priming and charging dynamite, 443; Priming with a fuse, 445; Tamping, 446; Charging Judson powder, Firing by electricity, 447; "Delay" fuses, 448; Misfires, 451; Blasting battery, 453; Methods of firing, 454; Miners' Squibs, Safety Fuse, 455; Detonators or caps, 456; Prices of blasting supplies, 459.

XI METHODS OF BLASTING 463

Theory of blasting, 463; Crater theory, 464; Placing holes, Methods of placing holes for blasting, 467; Springing holes, 471; Blasting with powder and dynamite together, 472; Chamber blasts, Chamber blasting for rock fill dam, 474; Chamber blasting in quarries, 479; Chamber blasts on railroad work, 485; Large chamber blasts, 487; Other chamber blasts, 488; Blasting cable drill holes, 491; Method of blasting at Grand Central Station, Blasting hardpan, 492; Blasting glacial drift, Mesabi District, 495; Cost of cemented gravel ballast, Tabulated blasting data, 496; Boulder blasting, 500.

XII LOADING AND TRANSPORTING ROCK 501

Units of rock pressure, Cost of loading by hand, 501; Cost of unloading scows by hand, 502; Cost of handling crushed stone, 503; Cost of handling crushed stone with a derrick, 504; Skip or scale pan, Price of steam shovels, 505; Cost of loading with steam shovels, Loading shale with a shovel on the Pennsylvania Railroad, 508; Use of small shovels, Outputs of steam shovels in iron ore, 509; Table: loading rock by steam shovels, 510; Cost of steam shovel work in slate, 512; Cost of steam shovel in shale, Cost of excavating gravel and boulders, 513; Cost of operating electric shovels, 515; Cost of hauling in cars with locomotives, Cost by wheelbarrows, 516; Hauling on stone boats, 517; Removing rock from a railroad cut on stone boats, 518; Removal by derricks and cars, 519; Cost of hauling in cars with horses, 520; Cost of dump car hauling, Prices of cars, 521; Cost of hauling in carts and wagons, 523; Cost of wagon hauling, 524; Cost of unloading and hauling crushed stone in wagons, 525; Comparative cost of hauling by teams and by traction engines, 526; Operations of cableways at Arrowrock Dam, 528; Cableway used at Morena Dam, 531; Cross references on cableways, Cost by endless rope gravity inclined plane, Prices of cableways, 533; Other cableway data, 537.

TABLE OF CONTENTS

CHAPTER	ix PAGE
XIII QUARRYING DIMENSION STONE	539
General considerations, 539; Joints, 540; Plug and feathers, 541; Cost of plug drilling by hand, 543; Cost of pneumatic plug drilling, 544; Hammer drills in quarrying, 545; Hammer drills in block hole work, 547; quarry bar, Brooch channeling, 548; Gadder, 549; Channelers, 551; Sizes of channelers, 554; Table: specifications of Ingersoll-Sergeant channelers, 555; Power required for channelers, Cost of channeling, Prices of channeling machines, Electric-Air channelers, Depth of cut, Bits, 556; Table: specifications of channeling machine steels, 558; Rate of cutting with channelers, Some records of channeling, drilling and cableway work, 559; Table: rate of cutting with Sullivan channelers, 560; Test of channeling machines in limestone, Cost of derricks, 561; Knox system of blasting, 562; Cost of quarrying for the Buffalo Breakwater, 563; Methods of quarrying marble, 556; Quarrying marble at Phenix, Mo., 567; Cost of quarrying dimension sandstone, 571; Quarrying by water cushion blasts, Granite quarrying, 572; Quarrying granite at Barre, Vt., 574; Granite sheet quarry, 575; Granite boulder quarry, 576; Plug drilling, Quarrying massive granite, 577; Splitting granite by compressed air, 578; Cost of quarrying granite, 579; Cost of quarrying gneiss, 580; Cost of quarrying sandstone, Cost of quarrying limestone, 581.	
XIV OPEN CUT EXCAVATION IN RUBBLE QUARRIES, PITS AND MINES	583
General considerations, Excavation in benches, 583; Spacing holes, 584; Table: cu. yds. of rock broken per lin. ft. of drill hole, for different spacing of holes, 585; Cable drill holes in quarry work, 586; Drill wagons in quarry work, 588; spacing and charging cable drill blast holes, 589; Loading and tamping cable drill holes, 590; Cost of drilling limestone with a cable drill, 591; Cost of quarrying trap for macadam, 592; Cost of quarrying and crushing limestone, 593; Cost of pit mining, Brewster, N. Y., 594; Cost of excavating iron ore in Tennessee, 595; Costs of pit mining near Rochester, N. Y., 597; Mining Mesabi iron ore, 599; Stripping an iron mine, 602; Cost of a cable drill in copper ore, 603; Cost of excavating gneiss, 604; Cost of gneiss excavation for dams, Cost of chamber blasting for a rock fill dam, Blasting rock for dam filling, 605.	
XV RAILROAD ROCK EXCAVATION AND BOULDER BLASTING	607
General considerations, spacing of holes, 607; Cost of railroad excavation in Tennessee, 607; Methods and cost of excavating granite in open cuts on the Grand Trunk Pacific, 613; Springing holes, 615; Rock excavation on the Watauga and Yadkin Railway, 620; Cost of excavating side hill cuts, 621; Cost of approaches to tunnel near Peekskill, N. Y., cost of excavating sandstone and shale, 623; Methods and cost of rail-	

way excavation in W. Va., 624; Cost of earth and rock excavation in steam shovel work, 628; One month's output of a steam shovel, 632; Method of blasting a railroad cut 1800 ft. long with one shot, 633; A 16,000 yd. blast in railroad work, 634; Diagram showing the increased cost of rock work with shallow depths, 634; Summary as to costs of open cut excavation, boulder blasting, 636; Table: dynamite charges for boulder blasting, 637; Comparative results of abode shots on limestone blocks, 638; Block hole drilling, 639; Cost of blasting boulders, 641; Cost of blasting boulders on Grand Trunk Pacific Ry., 643; Cost of breaking boulders by drop hammer, 644; Cost of breaking boulders by heating, Comparison of various methods of breaking boulders, 646; Table: cost of breaking boulders, 647.

XVI CANAL EXCAVATION 648

General conditions, Chicago Main Drainage Canal, 648; Excavating very tough clay, Excavating hardpan, 649; Incline and tippel, 651; Cost by Lidgerwood cableway, 653; Hullett-McMyler cantilever crane, or conveyor, 658; Hullett-McMyler derrick, 659; Geraldine double boom derrick, 660; Brown cantilever crane 661; Cost by car hoist inclines, 664; Summary of Chicago Canal costs, 666; Cost of channeling, 667; Cost of drilling, Steam shovel output, Chicago Canal, 669; The Panama Canal, 670; General statistics and equipment, 671; Wages and force, 672; Panama Canal Lock Excavation, 673; Culebra Cut, 674; Explosives and blasting, 675; Summary, 676; Steam shovel operation, 677; Table: Bucyrus and Marion steam shovel work, 678; Maintenance of shovels, 679; Transportation, 680; Spoil disposal, 681; Excavation records, 682; Table: cost per cu. yd. for various elements of the excavation, 683; Stream diversion and drainage, 685; Power plants, Panama Canal, 686; Shop facilities and service, Panama Canal, 687; Crushed stone, Panama Canal, 688; Pacific Locks, Panama Canal, 691; Sub-aqueous rock excavation, Panama Canal, Ditch excavation, with steam and electric shovels, Los Angeles Aqueduct, 692; Table: cost of open ditch excavation with steam shovels, 699; Records of channeling, drilling and cableway work, 700; Cost of excavation by bridge conveyor, New York State Barge Canal, 701; Cost of channeling rock on the New York State Barge Canal, 703; Cost of excavating Lock No. 5, New York State Barge Canal, 703; Table: steam shovel costs, New York State Barge Canal, 704.

XVII TRENCH WORK 705

General considerations, 705; Charging the holes, Use of a blasting mat, 706; Cost of drilling and blasting, 707; Removing rock from trenches, 709; Comparative cost of hand, steam and air drilling in Boston, Cost of a sewer excavated with hand drills, 710; Portable gasoline air compressors and hammer drills in trench work, 711; Air hammer drills in small sewer

TABLE OF CONTENTS

CHAPTER

xi
PAGE

trenches, 712; Steam operated air hammer drill in a trench, Drill carriages for trench work, 714; Other examples of trench work, 715; Cost of rock excavation for sewers in St. Louis, 717; Cost of pipe and brick sewers and manholes in St. Louis, 719; Cost of excavating granite in Ontario, 721.

XVIII SUBAQUEOUS ROCK EXCAVATION 723

Methods used to remove submarine rock, By dynamite lying on the rock surface, by cofferdams, caissons, or diving bells, 723; The platform method, the drill boat method, drilling, rock breaking by impact, rock removal, 724; drills used for subaqueous drilling, removal of submarine rock, 725; spacing of holes and amount of explosive required, cost of rock excavation in the Detroit River, 732; Table: submarine drills, 733; Table: spacing of holes and explosive used, 734; Table: dredging Detroit River, 738; Table: drilling on Detroit River, 739; Table: derrick scows, 740; Operation of the drill boat *Hurricane* on the Detroit River, 741; Drill scows and equipment, 743; Drill mountings, 744; Submarine drills, 745; charging tube, 747; Excavation at Buffalo, N. Y., 748; Cost of harbor excavation, Oswego, N. Y., 751; Dynamite, loading pipe, 752; Excavation on the Welland Canal, 753; Drilling and dredging in St. Lawrence River, 754; Excavation at Ahnapee Harbor, Wisconsin, 755; Cost of excavating Ashtabula Harbor, 756; High cost of rock excavation, Pier 14, New York Harbor, 759; Drilling and blasting in the Tennessee River, 760; Portable drill platform, 754; Removal of the Lytton Rocks, Brisbane River, 767; Drilling with a pile driver, Oconie River, Georgia, 768; Cost of a channel in basaltic rocks at Melbourne, 771; Hand churn drill on subaqueous work at Sydney, 772; Drilling by hand at Blyth Harbor, England, 773; Cost of drilling by hand at Freemantle Harbor, Australia, 774; Cost of excavation, Eagle Harbor, Mich., 775; Cost of excavating Black Tom Reef, N. Y., 776; Drilling and dredging Way's Reef, N. Y. Harbor, drilling in San Francisco Harbor, 777; drilling and dredging boulders, Wood's Hole, Mass., cost of undermining Flood Rock, Hell Gate, N. Y., 778; Cost of removing rock at Henderson's Point, Portsmouth Navy Yard, N. H., 779; The Lobnitz Rock Breaker, 780; Lobnitz cutting point, 783; Operations with Lobnitz rock breakers on the Suez Canal, 785; Cost by two methods at Blyth, England, 786; Comparative cost by a drill barge and a Lobnitz breaker, 788; Work of a rock breaker on the Manchester Ship Canal, 790; Methods of removing submarine rock at Malta, 791; Lobnitz rock breaker work at Black Rock Harbor, Buffalo, N. Y., 796; Table: Time record of machinery on Malta Harbor work, 797; Lobnitz rock breaker performance, Panama Canal, 798; Methods and costs of rock removal on the Upper Mississippi, 799; By chisel and dredge, 801; By drill boat, submarine blasting and dredge, 802; Table: cost at Rock Island Rapids, Records of rock dredging, 803.

LIST OF ILLUSTRATIONS

FIG.		PAGE
1	Planes of cleavage	6
2	Plug drill	27
3	Plug and feathers	27
4	Types of Machine drill bits	40
5	Drill bits in South African mines	44
6	Lug drill steel	45
7	High center bit	47
8	Weakness of sharp bits in turning	47
9	Steels used with Jackhammer and Rotator drills	48
10	Blacksmith's tools	54
11	Cooling bath	55
12	Distortion of bit by improper sharpening	55
13	Machine or power sharpener	59
13—A	B—C Special hollow steels	63
13—D	Punching hole in side of hollow steel	65
13—E	Carr bit	66
14	Sergeant rock drill	79
15	Chicago Giant tappet type rock drill	79
16	Sections through Butterfly rock drill, valve mechanism, etc.	79
17	Wood rock drill	80
18	Chicago Giant rock drill	81
19	TC Wizard rock drill	82
20	Sergeant slip rotation	84
21	Sullivan rifle bar and ratchet	84
22	Sergeant 32 drill chuck	85
23	Butterfly rock drill on tripod	95
24	Chicago Giant rock drill on column mounting—tunnel work	96
25	Rhode Island granite quarry, Sullivan drill and quarry bar	97
26	Ingersoll-Sergeant gadder	98
27	Sullivan hand hammer drill	119
28	Sullivan plug drill	120
29	Hardsoeg Wonder air hammer drill on a column	121
31	Drill connection used in sinking a mine shaft	123
32	Chart showing quantity of water required for sludge removal	131
33	Sullivan water reciprocating drill, tank and connections	133
34	Butterfly drill on column, with water spray	134
35	Section of No. 18 Leyner-Ingersoll	137
35—A	Sludge pump	140
35—B	Clamp extractor for removing steels	141
36	Auto traction rock-drill	142
37	Pump steel used with traction drill	145
37—A	Wagon drilling rigs on Champlain Canal	146
38	Section of Dulles-Baldwin rock drill	150
39	Electric-Air Pulsator drill on tripod	152
40	Drill cylinder of electric-air drill	153

LIST OF ILLUSTRATIONS

FIG.		PAGE
41	Section of pneumelectric rock drill	155
42	Scott gasoline drill, sectional view	157
43	Scott gasoline drill (C-7) on drifting work	158
44	Rice gasoline rock drill	159
45	Portable drilling outfit, Sullivan Machinery Co.	194
46	Portable gasoline driven air compressor	249
47	Standard rig arranged for spudding	253
48	String of tools used with standard drilling outfit-temper screw	254
49	Keystone well-drill, No. 3½ traction, with electric motor	258
50	Spudder on No. 14 Cyclone drill	259
51	String of cable tools	260
52	Cable drill bits	262
54	Churn drill bit with hollow tube	273
55	Regular and Mother Hubbard patterns of churn drill bit	286
56	Little David drill, partly in section	298
56—A	Swing spider	305
56—B	Temper screw with clamps on drilling line	307
56—C	Hydraulic elevator for moving casing, in circulator system	309
56—D	Fishtail bit	311
56—E	Sharp and Hughes cone bit	311
56—F	Broadside view of Sharp and Hughes cone bit	312
56—G	Sharp and Hughes cone bit ready for operation	313
56—H	Complete rotary drilling outfit	315
57	Diamond drill bit	326
58	Diamond drill in operation	335
59	Sullivan class M hand power diamond drill	336
60	Diamond drilling rig	339
61	Spudding bits and augers used in diamond drilling	340
62	Section of surveying instrument	344
63	Azielinometer	344
64	Compass for determination of course of drill hole	345
65	Caliper for drill holes	346
66	Sullivan diamond drill drilling an upper hole	356
67	Sullivan "Champion" core drill	364
68	Sullivan class "S" diamond core drill	368
69	Cement mixer for grouting shafts	373
70	Swivel head for drilling machine	374
71	Rotating mechanism for drilling machine	374
72	Sections of drill rods	375
73	Core lifter and diamond bit	376
74	Class "F-1" Calyx drill	378
75	Davis cutter used on the Calyx drill	380
76	Spudding with chopping bit, with water jet attached	381
77—A-B-C	Core drill parts	382
77—D-E-F	Core drill parts	383
78	Section showing core drill rod, etc.	384
79—A-B	Parts of core drills	385
80—A-B-C	Parts of core drills	386
81	Recovering taps	387
82	Class "F" steam driven Calyx drill outfit, drill, engine and hoist	388
82—A	Apparatus for testing borings by hydraulic pressure	400

FIG.		PAGE
83	Small thawing magazine	421
84	Small thawing kettles	422
85	Elevation of thaw house for frozen explosives	423
86	Section of thaw house for frozen explosives	424
87	Thaw house, Portland Mine, Mich.	425
88	Front elevation and plan of ventilation of brick magazine	427
89	Sections of magazine	428
90	Priming with a fuse cap	445
91	Different methods of inserting an electric detonator	448
92	Methods of splicing wires	449
93	Methods of wiring	450
94	Two-post blasting machine	453
95	Electric detonator	458
96	Crater	465
97	A-B-C-D-E-F-G Drill hole spacing	465, 468, 470
98	A-B Blasting with dynamite and powder together	473
99	Tunnel for blast at West Beaver Creek, Col.	475
100	Plan and profile of large blast	477
101	Plan of loading and tunnels for quarry blast	480
102	Plan of location of tunnels for a large blast	482
103	Plan of tunnels and charges for large blast at St. Helena, Ore.	483
104	A-B Plan of tunnels for blasting and method of charging	485
105	Plan showing location of tunnels	486
106	Plan of coyote hole for blast at Linnton Prison Stockade, Ore.	490
107	Blasting at Grand Central station	492
108	Skip or scale-pan	505
109	Pole track and arrangement for dumping stone boats	518
110	Diamond frame double side dump car	521
111	An eight yard car in dumped position	522
112	Plan of Morena Dam, showing cableway	532
113	Duplex cableways on Hennepin Canal	535
114	Sewer cableway	536
115	Plug and feathers	542
116	Plug drills and chisels	543
117	Plug hole drilling	544
118	Hammer drill drilling 15 ft. holes	545
119	Blockholing	546
120	Quarry bar	547
122	Gadder in a quarry	549
123	Simplex channeller	550
124	Duplex channeller	551
125	Channeled walls of wheel pit	552
126	Steels for channeller bits	557
127	A-B Knox blasting	562
128	Open marble quarry	566
129	Channeling into a 45° tunnel cut	567
130	Opening a Vermont quarry, Sullivan corner cutter and channeller	568
131	Quarrying marble by the tunnel method	569
132	Marble block 23 x 13 x 5 ft. cut by chunnelers	570
133	A-B Methods of granite quarrying	573
134	Granite sheet quarry	575

LIST OF ILLUSTRATIONS

FIG.		XV PAGE
135	Granite boulder quarry	576
136	Splitting granite by compressed air	578
137	Plan of drill holes, Treadwell Mine	585
138	Plan of bench	585
139	Profile of bench	585
140	Longitudinal section of cut	616
141	Front view of cut	616
142—A	Plan of blast holes in cut	622
142—B	Profile of side hill cut	622
143	Devil for handling boulders	627
144	Layout of holes and wiring for blasting a railroad cut	633
145	Diagram: relation of unit cost of excavation to depth of cut	635
146	Mudcapping	639
147	Snakeholing	639
148	Blockholing	639
149	Chicago Main Drainage Canal	649
150	Coyote hole in hardpan	650
151	Incline and hoist	651
152—A-B	Track layout for incline	652
153—A	Incline and tippie	652
153—B	Derrick and air hoist	653
154	Lidgerwood cableway	655
155	Hullett-McMyler cantilever crane	655
156	Arrangement of cranes on canal	659
157	Hullett-McMyler derrick	660
158	Geraldine double boom derrick	660
159	Brown cantilever crane	662
160	Incline for car hoist	665
161	Track arrangement and incline	666
162	Typical section of open canal	694
163	Two shovel method	697
164	Bridge conveyor excavator, New York State Barge Canal	702
165	Blasting mat	707
166	Drill carriage for trench work	715
167	Portable boiler and drill for trench work	716
168	Spacing drill holes	718
169	Profile of Tam Avenue sewer	720
170	Corliss submarine drills, with 7 in. cylinders	731
171	Drill boat "Hurricane"	743
172	Drill frame on a drill boat	746
173	Plan and elevation of drill float and tender, Tennessee River	761
174	Details of portable platform for drilling on river bottom	766
175	Portable drill platform with drill mounted and ready for operation	767
176	U. S. Dredge Sapelo at Bells Ferry, Oconee River, Georgia	770
177	Ingersoll-Sergeant submarine drills at Portsmouth, N. H.	780
179	Lobnitz Rock Breaker	782
180	Projectile or cutter used with Lobnitz rock breaker	784
181	Submarine drilling scow	789
182	Cross section of drilling float	791
183	Details of tube and chisels	792
184	Method of working stern wheel dredger	793

LIST OF TABLES

NUMBER		PAGE
I	Specific gravity of common minerals and rocks . . .	12
II	Specific gravity and weights for given % of voids . . .	13
III	Summary of speeds of hand hammer drilling . . .	34
IV	Shapes of air hammer drill bits and relative speeds . . .	40
V	Weight of drill steels for percussive drills . . .	50
VI	Weights in lbs. per ft. of solid and hollow drill steels . . .	51
VII	Tappet valve drills	86
VIII	Corliss valve drills	80
IX	Air valve drills	80
X	Unmounted air hammer drills	107
XI	Air-feed or cradle-mounted hammer drills	118
XII	Average time drilling vertical holes	164
XIII	Average time drilling holes in a breast	165
XIV	Time of drilling operations on nine jobs	169
XV	Drilling costs, Pennsylvania Quarry	172
XVI	Hp. required to compress air to given pressures . . .	213
XVII	Steam—Volume and temperature at given pressures . . .	214
XVIII	Rates of drilling at different pressures	215
XIX	Rates of drilling at different pressures	216
XX	Rates of drilling at different pressures	216
XXI	Test of Leyner-Water drill	217
XXII	Diversity factors for compressor capacities	220
XXIII	Cu. ft. of air required to run a one-drill plant	221
XXIV	Factors for compressor capacities	222
XXV	Losses of steam through bare pipe	224
XXVI	Pipe coverings	225
XXVII	Surface area of pipe of given diameter	226
XXVIII	Air line pipe, sizes and weights	229
XXIX	Factor "L" for flow of air through pipes	232
XXX	Factor "F" for flow of air through pipes	232
XXXI	Factor "M" for flow of air through pipes	232
XXXII	Sizes of well drills	257
XXXIII	Speed of drilling with cable or well drills	263
XXXIV	Costs of ore prospecting	282
XXXV	Time and speed of drilling well holes	285
XXXVI	Cost of drilling in New Mexico	289
XXXVII	Time table of twenty months drilling	290
XXXVIII	Analysis of stone consumption	332
XXXIX	Progress table of diamond drilling	367
XL	Cost of diamond drilling	361
XLI	Cost of diamond drilling	362
XLII	McKiernan Terry Shot Core Drills	380
XLIII	Cost of Calyx shot drilling	391

LIST OF TABLES

NUMBER		PAGE
XLIV	Sizes of black blasting powder	404
XLV	Lbs. of powder per ft. of hole for different size holes	404
XLVI	Explosives equivalent in strength to Atlas	408
XLVII	Straight dynamite	409
XLVIII	Low freezing dynamite	409
XLIX	Ammonia dynamite	410
L	Gelatin dynamite	410
LI	Weight of explosives in lbs. per ft. of drill hole	415
LII	Permissible explosives	415
LIII	Safe storage distance of dynamite from buildings	429
LIV	Lead block tests with 40% dynamite	433
LV	Energy of explosives	438
LVI	Toughness of rocks	439
LVII	Percussive drill hole blasts	497
LVIII	Cable drill hole blasts	498
LIX	Notes on chamber blasting	499
LX	Prices of steam shovels and derrick excavators	506
LXI	Loading rock by steam shovel	510
LXII	Sullivan channelers	554
LXIII	Ingersoll-Sergeant channelers	555
LXIV	Specifications of channeling machine steels	558
LXV	Rates of cutting with Sullivan channelers	560
LXVI	Quarrying costs and data	565
LXVII	Cu. yds. per ft. of hole for different spacing of drill holes	585
LXVIII	Costs of railroad cut excavation	610
LXIX	Costs of railroad cut excavation	612
LXX	Dynamite charges for boulder blasting	637
LXXI	Adobe shots and blockhole tests on limestone blocks	638
LXXII	Costs of blasting boulders	641
LXXIII	Costs of blockholing five boulders	642
LXXIV	Costs of undermining and blasting boulders	643
LXXV	Costs of breaking boulders by different methods	647
LXXVI	Excavation costs on the Chicago Drainage Canal	666
LXXVII	Excavation outputs for different methods of conveying	667
LXXVIII	Excavation costs on Culebra Cut	683
LXXIX	Open ditch excavation with steam shovels	699
LXXX	Drilling in trench work, time and speed	717
LXXXI	Submarine drills	733
LXXXII	Submarine drilling, spacing of holes, and explosives	734
LXXXIII	Dredging Detroit River Improvement	738
LXXXIV	Drilling Detroit River Improvement	739
LXXXV	Derrick scows Detroit River Improvement	740
LXXXVI	Time records of machinery at Malta Harbor	797
LXXXVII	Cost of rock excavation, Rock Island Rapids	803

CHAPTER I

ROCKS AND THEIR PROPERTIES

Rock-forming Minerals. All rocks are aggregates of one or more minerals or the disintegrated products of minerals. A mineral is an inorganic body having a definite chemical composition, as quartz, common salt, mica, and the like. There are about 1,000 distinct species of minerals, but fortunately the common rock-forming minerals number less than 30; and of these 30 perhaps 15 should be recognized at sight by everyone who aims to become an expert in rock excavation.

A small cabinet of the common species of minerals may be purchased for a few dollars from any of the dealers whose advertisements may be found in the mining and civil engineering journals. Such a cabinet when studied with the aid of a book on mineralogy will assist one in undertaking the work of rock excavation intelligently.

It is often said that "a little knowledge is a dangerous thing"; but a little knowledge of fundamental principles, whether of geology or of any other of the physical sciences, is exactly the opposite of dangerous. A little knowledge of a few scientific facts, it is true, often leads to incorrect rules or generalization; but a knowledge of correct rules and fundamental principles, based upon the observation and study of many facts by experts, is the kind of little knowledge that no man can afford to be without. Thus, for example, geologists classify rocks according to their origin into two great classes, (1) sedimentary or stratified, and (2) crystalline, or igneous. A contractor, who had lost many thousand dollars on some rock excavation in the northern part of New York, once told me that he attributed his loss to a lack of knowledge of these elementary geological facts. His previous experience had been confined to the shales and sandstones of Pennsylvania. When he came to estimate the cost of excavating a granitic rock he made allowance for its greater hardness and toughness as affecting the speed of drilling; but he failed to consider the fact that the absence of lines of stratification in the granite would necessitate placing drill holes much closer together than in shale or sandstone. The result was that not only the cost of drilling but the cost of explosives per cubic

yard of granite excavation was practically double what he had counted upon.

Every mining man can cite striking instances to show how ignorance of the elementary facts of geology and petrology have led to serious underestimates of the cost of tunneling, shaft sinking and stoping. It is true that where an engineer, contractor or miner works all his life in one locality he becomes so expert in his knowledge of the methods and cost of rock excavation that he sees little practical value to himself in a knowledge of minerals, rocks or geologic principles. But when, possibly late in life, he goes to a new field of action, he is likely to lose his reputation, if not his money, through lack of a "little knowledge" of the fundamental principles of rock formation. The science which he has regarded as being too theoretical for him might have saved him had he possessed even a little of it.

I therefore repeat that the man who aims to become an expert in all kinds of rock excavation, should first learn to know the common species of minerals at sight, or by means of the simple tests described in books on mineralogy. It is beyond the province of this book, however, to describe rocks and rock forming minerals. There are several excellent books on that subject, with one or more of which the rock excavator should be familiar.

Hardness. The resistance to scratching or cutting is termed hardness. Diamond is the hardest mineral known, as it will scratch all others. Talc is one of the softest minerals. Mineralogists use a scale of hardness as follows:

- | | |
|--------------|--------------|
| 1. Talc. | 6. Feldspar. |
| 2. Gypsum. | 7. Quartz. |
| 3. Calcite | 8. Topaz. |
| 4. Fluorite. | 9. Corundum. |
| 5. Apatite. | 10. Diamond. |

The sharpest point of a steel knife will not scratch quartz, but under considerable pressure will scratch feldspar. A very slight pressure on the knife will scratch talc or gypsum; indeed the finger nail will serve to scratch them. The test of hardness often serves to distinguish one mineral from another; for instance, iron pyrites and copper pyrites are similar in color, but while copper pyrites can be scratched with a knife, iron pyrites cannot. To distinguish sandstone from limestone it is often necessary merely to draw a sharp corner of the stone across a pane of glass. Glass has a hardness of about 5.5. If a scratch is left in the glass the stone can not be pure limestone, since calcite, which has a hardness of 3, is the mineral

forming limestone. Impure limestone may be a mixture of fine grains of quartz and calcite; but after a little experience in testing stones and minerals the eye will aid to such a degree in determining the species that the test of hardness becomes a very reliable one in many cases.

Hardness of course affects the speed of drilling in rock, although to a less degree than toughness. A tough rock is one that will stand a hard blow without splintering. Window glass is quite hard, almost as hard as tempered steel, but it is not very tough. Sandstone is hard, so far as its individual grains are concerned, but is often drilled with ease, since it usually lacks in toughness. Trap rock is both hard and tough, and makes drilling difficult, besides dulling the drill rapidly.

Rock Species. Rocks may be classified as: (1) Sedimentary; (2) igneous, and (3) metamorphic. Sedimentary rocks have been deposited originally from suspension or solution in water; thus sand hardened into rock becomes sandstone; clay becomes shale or slate; gravel becomes conglomerate or pudding stone; wood fiber becomes peat or coal; shells of minute forms of sea life form limestone, or possibly lime in solution crystallizes out as does rock salt. The chief characteristic of sedimentary rocks is that they lie in beds or strata, one upon the other, often not cemented together in the slightest degree; and even where they appear to be solid and massive they can usually be split into slabs by wedging.

The igneous rocks have at one time been in a molten condition, and include the traps, porphyries, most granites, and all volcanic lavas, etc. Igneous rocks are often exceedingly tough, hard to drill, and are apt to break out in very irregular masses, sometimes of huge size and in other cases of too small a size to make cut stone masonry.

The metamorphic rocks, may be said to be a "cross between" the sedimentary and the igneous rocks, for they have been formed by chemical and physical changes in sedimentary rock under the influence of heat, water and pressure. For example, a dike of molten rock rising through a fissure in shale heats the surrounding shale to such a degree that, in the presence of confined water, the shale "melts," and, when it solidifies by subsequent cooling, a gneiss is produced. Some granites are known to have been made in this way by what is called metamorphic action. Marble is metamorphosed limestone, and quartzite is metamorphosed sandstone.

While rocks are divisible into these three great classes according to their geological origin, they are subdivisible into species according to their mineral constituents, as follows:

Igneous Rocks

- (1) Massive, with quartz and orthoclase
 - (a) Granites and granite porphyries
 - (b) Quartz porphyries
 - (c) Lisparites
- (2) Massive, without quartz
 - (a) Syenites
 - (b) Quartz-free porphyries
 - (c) Trachites and phonolites
- (3) Plagioclase rocks
 - (a) Diorites and diorite porphyries
 - (b) Diabases, gabros, melaphyrs, and basalts
- (4) Rocks without feldspars
 - (a) The peridotites (serpentine in part)
 - (b) The pyroxenites (soapstone in part)

Aqueous Rocks

- (1) Sedimentary
 - (a) Silicious: sandstones, conglomerates, breccias and slates
 - (b) Calcareous: limestones, and dolomites
- (2) Chemical precipitates: Onyx marbles, travertines, gypsum and alabaster

Metamorphic Rocks

- (1) Gneisses and schists
- (2) Marbles
- (3) Quartzites
- (4) Serpentes (verdantique marbles in part)

Joints. All rocks are more or less split up along vertical or nearly vertical planes, termed joints, which greatly assist in the quarrying. Joints are the results of stress, due to shrinkage of the earth's crust upon cooling. This shrinkage has produced great compression in some places and tension in others, resulting in cracking of the rock masses at more or less regular intervals.

In limestone and in close grained shales the joints are often regular but so close as to be invisible until revealed by fracture or by weathering. In coarse grained sedimentary rocks, the joints are apt to be more open and irregular, running into one another or branching.

In sedimentary rocks there are generally two sets of joints running approximately at right angles, known as the dip-joints

and the strike-joints. The "dip" of the rock is the angle that its bedding planes make with a horizontal plane. The "strike" is the line of intersection between an inclined plane and a horizontal plane; thus, if a sheet of cardboard be held at an incline in a basin of water, the line of the water surface along the face of the cardboard is the "strike." Since a quarry is usually worked to the dip of the rock, the strike joints, or "backs," form clean cut faces in front of the workmen as they advance; while the dip joints, or "cutters" form the side faces of the benches in the quarry. Thus it happens that in some sedimentary stone quarries, nature has provided blocks of stone, practically loose on all six faces; but, as a rule, the joints are so irregularly spaced as to require much plug and feather work.

Igneous rocks, while not possessing bedding planes, also have nearly vertical joints, cutting at about right angles in most cases; but these joints are seldom so regular in spacing as in sedimentary rocks. In certain trap rocks the joints cause the rock to break out in vertical columns, often of great regularity; and in some cases the joints are so close together that upon firing the blast the rock comes down in chunks not much larger than a man's head, even where very little explosive is used; but, on the other hand, certain traps break up in very large chunks on blasting.

Veins and Beds. Iron ores and coal occur for the most part in beds that originally were nearly horizontal, since they are of sedimentary origin. They are, or at one time have been, overlaid by sedimentary rocks.

Veins carrying the ores of the valuable metals are in some cases fissures or cavities that have been filled by hot waters carrying minerals in solution. These fissure veins exist in both sedimentary and in igneous rocks, but as a rule near dikes or sheets of igneous rocks that were at one time in a molten state.

General Names. There are certain terms that are often applied to classes of rocks.

Porphyry is any rock composed of a fine ground mass in which large crystals are found. The term is applied by miners to many kinds of igneous rocks.

Groundmass is the compact matrix in which the crystals are embedded.

Trap rock is a term applied to almost any fine grained rock of igneous origin, such as basalt, diorite, diabase, etc.

Greenstone is a term formerly used to designate basic eruptive rocks occurring in dikes. It has come to include dark green or nearly black rocks like diabase and diorite, so that the

term greenstone is used by some where others use the term trap.

Bluestone is a word that is applied to widely differing kinds of stone; in Ohio, a gray sandstone; in Pennsylvania and New York, a blue-gray sandstone; in Maryland, a gray gneiss; in other states, other rocks.

Frestone is any stone that cuts freely, or easily, in any direction, as certain sandstones and limestones do.

Flagstone is a term applied to any stone that is readily split into slabs suitable for flagging. Sandstones, slates and some schists are the common flagstones.

Quarrymen's Terms. *Bastard granite* is frequently used to designate gneisses, schists and other rocks resembling granite in a general way; it is also a term applied to dike rock occurring in a granite quarry.

Clay-holes are cavities in a stone which are filled with clayey or sandy material.

Drys are natural seams usually invisible in freshly quarried rock, but which are brought out during the cutting of the rock or upon exposure.

Niggerhead is a quarryman's term applied to:

- (1) Boulders or rounded field stones;
- (2) Black nodules found in granite;
- (3) Slaty rock occurring with sandstone.

Plucky is a term applied to stones that, under the chisel, break away in irregular conchoidal (shell-like) chips, thus making it difficult to secure a smooth face. Silicious, compact limestones are often plucky.

Quarry water is the water in the pores of freshly quarried stone. Most of this water evaporates upon long exposure of the quarried stone; then the stone is said to be *seasoned*.

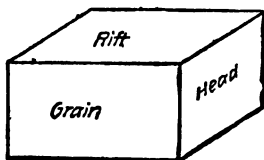

Fig. 1. Planes of Cleavage.

Fig. 1 shows a block of granite which can be readily split in planes parallel to the face marked "rift," less easily in planes parallel to the face marked *grain*, and still less easily in planes parallel to the face marked *head*.

Sap is a term applied to the decomposed and iron-stained portions of rock in joints along which surface waters have passed.

Rift is the direction in which a rock splits most readily. In sedimentary rocks the rift is parallel with the beds of stratification. Most of the traps and porphyries have no regular rift, but nearly all the granites have a distinct rift.

Stock is useful rock quarried as distinguished from the waste.

Granite. Granite is composed of quartz, feldspar and mica; the quartz acts as the cement, binding the whole together in a crystalline mass. When the percentage of feldspar is large the granite is said to be porphyritic. The specific gravity is from 2.55 to 2.86.

The common color of granite is gray, but pink, yellowish, and almost black varieties are common. Certain granites may be split into blocks with remarkable regularity and ease by the use of a hammer, while other varieties do not split well with a hammer but split well by the use of plugs and feathers.

Gneiss. This is often called stratified or bastard granite. It contains the same minerals as granite but the minerals are arranged in more or less parallel layers, giving a schistose structure which causes the rock to split much more easily in a direction parallel with the schistose layers than in any other direction. Its specific gravity is 2.62 to 2.92.

Porphyry. There are two principal varieties of porphyry: (1) Quartz porphyry, and (2) Orthoclase (or quartz-free) porphyry. Quartz porphyry consists of a fine grained mass in which quartz, or quartz and orthoclase, occur as large crystals. When the quartz is visible as well marked grains or crystals, the rock is generally called quartz-porphyry; but when the quartz and feldspar are so intimately mixed as not to be readily distinguished, the term felsite is more often used. Porphyry is also an overworked name applied by miners to almost any igneous rock whose real name they do not know.

In orthoclase porphyry the ground mass contains the same accessory minerals as granite but usually in microscopic crystals. The specific gravity is about 2.5.

Lisparite. Lisparites are acid eruptive rocks or lavas consisting chiefly of quartz and a glassy variety of orthoclase called sanadin. According as their texture is crystalline, porphyritic, or glassy, lisparites are classified as follows: (1) Nevadites, or granitic lisparites; (2) Rhyolites, or porphyritic lisparites; (3) Glassy lisparites, such as obsidian, pumice, pearlite and pitchstone. The specific gravity is about 2.55.

Syenite. Syenite consists essentially of orthoclase with or without one or more of the accessory minerals mica, hornblende or augite.

Syenite is really a granite without quartz. The specific gravity is 2.27 to 2.65.

Trap. Trap is another overworked name that is commonly applied to fine grained rocks of igneous origin. Among the trap rocks are: Diabase, diorite, basalt, etc. The trap rocks usu-

ally have irregular joints, and, while due to their toughness they may be excellent material for macadam, are seldom fit for building purposes, except when crushed and used in concrete.

The Hudson River trap (diabase) has a specific gravity of about 2.95.

Diabase. Diabase is a crystalline granular rock whose essential minerals are plagioclase feldspar and augite, or pyroxene, accompanied nearly always by magnetite. The texture is, as a rule, fine and compact. The color is greenish, dark gray, and black. The specific gravity is 2.6 to 3.03. The trap rock of the Hudson River Palisades is diabase. The diabase from Maine is known commercially as "black granite." The Pennsylvania diabase quarried near Gettysburg, is known as "Gettysburg granite."

Gabbro. Gabbro differs from diabase in containing the pyroxene diallage in place of augite. "Duluth granite" is a dark blue gray gabbro quarried near Duluth, Minn.

Norite. This consists essentially of hypersthene and plagioclase feldspar. The norite quarried near Keeseville, N. Y., is known as "Au Sable granite," and that quarried at Vergennes, Vt., as "Labradorite granite." Both are coarse grained and dark gray.

Basalt. Basalt is mineralogically the same as diabase, but usually finer grained, less perfectly crystalline, and more glassy. It is difficult to "work." The specific gravity is about 3.

Diorite. This rock consists essentially of hornblende and plagioclase. The texture is usually fine but occasionally porphyritic. The common colors are dark gray and dark green. The specific gravity is about 2.92.

Andesite. This consists essentially of a triclinic feldspar and hornblende augite, or black mica. The principal varieties are quartz, andesite, hornblende andesite, augite andesite, and mica andesite.

Sandstone. As its name implies, sandstone is sand cemented together. The cementing material is commonly silica or iron oxide (iron rust). When cemented by silica the rock is apt to be very tough and far more durable than when cemented by iron rust; and is consequently more difficult to drill. Sandstone generally contains enough iron oxide to give it a red or brown color. White sandstone, as well as dark blue, is quite common. Sandstone often contains enough clay to make it difficult to classify it: in such cases it is usually very fine grained and may be mistaken for slate, especially when it splits into thin slabs.

"Connecticut brownstone" is a sandstone, as is "New Jersey brownstone," and both consist of grains resulting from the

breaking up of granite, which have been cemented by iron oxides, silica and carbonate of lime. New York sandstones may be divided into three groups: (1) the bluestone of the Hudson River; (2) "Medina sandstone" of Western New York; and (3) "Potsdam sandstone" of Northern New York. Pennsylvania sandstones are classed as follows: (1) Brownstone of Triassic age; (2) Sandstone of the coal measures; and (3) Bluestone of Wyoming Valley. Ohio sandstones are known as "Berea grit," quarried at Berea, Amherst and elsewhere in Lorain and Cuyahoga counties; as "Euclid bluestone," quarried at Euclid, Cuyahoga County; and as fine grained buff and blue-gray sandstone from the southern part of the state.

Quartzite. Quartzite is a metamorphosed sandstone made dense and crystalline either by heat and pressure or by the deposition of silica between the sand grains. Its specific gravity is 2.6 to 2.7.

Slate. Roofing slate is a silicious clay that has been more or less metamorphosed by heat and pressure. If the metamorphic action is carried far enough the slate passes by insensible graduations into mica-schist. Strangely enough slates do not split parallel with the original bedding planes but at angles with the bedding planes.

Shale. Shale is really a baked clay or mud, generally yellow, brown or black in color, and easily split into leaves. Under great pressure shale has often been converted into slate in which the pressure has forced the long particles into a position perpendicular to the line of pressure, and imparted lines of cleavage entirely independent of the original bedding planes of the shale. Shales often contain silica and lime to a degree that makes their classification puzzling. Dry clay upon absorbing water swells, so that clays which have been only partly baked into shale absorb water upon exposure and go to pieces; moreover, the swelling often causes great difficulty in tunnelling or shaft sinking, since the force developed by absorbing water may crush or displace the timbers used in lining.

On the other hand well hardened shales do not swell upon exposure and, if not exposed to great changes in temperature, have long life. It often becomes a very important economic question to decide whether a tunnel through shale should be lined with concrete or masonry. Many civil engineers have made serious blunders through lack of scientific knowledge of the properties of the different shales. If an engineer has had experience only with half-baked shales, he is apt to line with masonry every permanent tunnel that he builds in shale, regardless of the kind of shale; while, on the other hand, an engineer whose experience has been with well baked shales may err by

failing to provide lining for tunnels in half-baked shales. I could mention several instances of economic errors of this kind, but I have perhaps emphasized sufficiently the advantage possessed by the engineer who has a good working knowledge of rocks and of geology.

Limestone. As its name implies, limestone is the rock from which lime is made. It is seldom pure (calcite), usually containing more or less clay, and often silica. By dissolving some powdered limestone in nitric acid the amount of impurity may be roughly ascertained, for neither clay nor quartz is dissolved by the acid. In some cases it will be found that there is less limestone than clay in the so-called limestone. Due to the presence of impurities, few rocks vary more in compactness and appearance than does limestone. When pure, it is hard and crystalline; but friable, chalky deposits of limestone are not uncommon. The common color is a gray, or a blue gray, passing into white.

If limestone contains much quartz it is *silicious limestone*. An *argillaceous limestone* is one containing clay. *Hydraulic limestone* contains 10% or more of quartz and usually some clay. A *ferruginous limestone* contains iron oxide as the principal impurity. *Oolitic limestone* consists of small rounded grains cemented together. *Shell limestones* are made up of shells. The "coquina" of Florida is of the same general nature except that it is composed of coral fragments. Chalk is a fine-grained white limestone composed of exceedingly minute shells. *Travertine* is a limestone that has been deposited from hot springs. *Stalactites* and *stalagmites* are limestones deposited on the roofs and floors of caves from cold water solutions. *Marble* or *crystalline limestone* is strictly speaking a granular aggregate of calcite crystals resulting from metamorphic action; but the term marble is commonly applied to any limestone or dolomite that will take a polish. *Dolomite* is an aggregate of the mineral dolomite, a magnesium limestone. The eye can not distinguish it from limestone but it is harder, heavier, and less soluble in acids.

Weight and Voids. Civil engineers commonly measure rock excavation by the cubic yard in place before loosening, whereas mining engineers generally use the ton of 2,000 lb., as the unit of rock and ore measurement. In view of this fact it would be well were the specific gravity of the rock given by every engineer who publishes data on any particular kind of rock excavation or mining. Then, too, it often happens that broken rock is purchased by the ton even for civil engineering work, or by the cord of loosely piled rubble for architectural work;

hence the importance of stating not only the specific gravity but the percentage of voids.

The specific gravity of any material is the quotient found by dividing its weight by the weight of an equal bulk of water. Water, therefore, has a specific gravity of 1; a cubic foot of any substance like granite, having a specific gravity of 2.65, weighs 2.65 times as much as a cubic foot of water. A cubic foot of water weighs 62.355 lb., or practically 62.4 lb.; hence a cubic foot of solid granite weighs, $2.65 \times 62.4 = 165.3$ lb.

When any rock is crushed or broken into fragments of tolerably uniform size it increases in bulk, and is found to have 35% to 55% voids or inter-spaces, depending upon the uniformity of the fragments and their angularity. Rounded fragments, like pebbles, pack more closely together than sharp-edged or angular fragments. A tumbler full of bird shot has about 36% voids, and it is possible to hand-pack marbles of uniform size, so that the voids are only 26%. Obviously, if small fragments of stone are mixed with large fragments the voids are reduced. Pit sand ordinarily has 35 to 40% voids. Hard broken stone from a rock crusher has about 35% voids if all sizes are mixed and slightly shaken down in a box; whereas, if it is screened into several sizes, each size has about 45 to 48% voids. For further data on voids in crushed rock and gravel see the author's "Handbook of Cost Data."

A soft and friable rock-like shale breaks into fragments having a great range in size, from large chunks down to dust; and, as a consequence, such soft broken rocks have a much lower percentage of voids than the tougher rocks.

The following table shows the swelling of rock upon breaking:

Voids	30%	35%	40%	45%	50%	55%
No. of cu. yds. (loose measure) } made by each cu. yd. of solid } rock	1.43	1.54	1.67	1.82	2.00	2.22

Hard rock when blasted out in large chunks and thrown into cars or skips may ordinarily be assumed to have from 40 to 45% voids, hence 1 cu. yd. of hard solid rock ordinarily makes 1.67 to 1.82 cu. yd. of broken rock.

The exact ratio in volume of solid rock to rock in fill depends mainly on the size of the pieces and the amount of earth that is mixed with the larger sizes. Mr. W. L. Sisson states that in limestone and mica schist "50,000 cu. yd. of solid rock cutting, in cuts up to 80 ft. in height, when broken up and hauled on an average 2,600 ft. to embankment, made nearly 90,000 cu. yd., an increase of 80%." This is in the ratio of 1 to 1.8. At Boulder, Colorado, a cut of 3,600 cu. yd. made an embankment of 5,340 cu. yd. which is in the ratio of 1 to 1.51.

In blasting rock for excavation on railroads, the mass comes out in pieces of all sizes, and when placed in the embankment voids of considerable size are made between the pieces. If the excavated rock has a layer of overlying earth on it that has not been stripped off before the rock is blasted, much of this earth and the rock that is ground up fine go to fill these voids, making the embankment more compact than where no earth is excavated in connection with the rock. The result is that rock by itself "swells" more than it does when excavated in connection with earth and loose rock. With solid rock, first stripped and then excavated, the example given at Boulder is a fair average; but where the solid rock is excavated in connection with earth, the ratio is about 1 of solid rock and earth in place to 1.4 of broken rock and earth in the embankment.

Tables of Weights of Rock. Tables I and II will be found useful for computing the weight of solid or broken rock from the specific gravity. Thus, suppose it is desired to ascertain the weight of a solid cubic yard of granite, also the weight of a cubic yard of crushed granite having about 40% voids. In Table I it is seen that granite has a specific gravity of 2.55 to 2.86; assuming 2.7 as an average and turning to Table II, we find that a rock having a specific gravity of 2.7 weighs 4,546 lb. per cu. yd. solid, or 2,727 lb. per cu. yd. when broken up so that 40% of the mass is voids.

On the other hand, if the weight per cubic yard of the loose broken stone is known (as is often the case), and if the specific gravity has been determined by a test, then Table II can be used to find the per cent. of voids in the broken stone. Thus, if a given sandstone has been found to have a specific gravity of 2.4, and upon shipping in cars it has been found to weigh 2,200 lb. per cu. yd., measured loose in the car box, then from Table II, it is seen that about 45% of the mass of broken stones is voids.

TABLE I. SPECIFIC GRAVITY OF COMMON MINERALS AND ROCKS.

Apatite	2.92—3.25	Gypsum	2.3 —3.28
Basalt	3.01	Halite (salt), NaCl	2.1 —2.56
Calcite, CaCO ₃	2.5 —2.73	Hematite, Fe ₂ O ₃	4.5 —5.3
Cassiterite, SnO ₂	6.4 —7.1	Hornblende	3.05—3.47
Cerussite, PbCO ₃	6.46—6.48	Limonite, Fe ₂ O ₄ (OH) ₆	3.6 —4.0
Chalcopyrite, CuFeS ₂	4.1 —4.3	Limestone	2.35—2.87
Coal, anthracite	1.3 —1.84	Magnetite, Fe ₃ O ₄	4.9 —5.2
Coal, bituminous	1.2 —1.5	Marble	2.08—2.85
Diabase	2.6 —3.03	Mica	2.75—3.1
Diorite	2.92	Mica Schist	2.5 —2.9
Dolomite, CaMg(CO ₃) ₂	2.8 —2.9	Olivine	3.33—3.5
Feldspar	2.44—2.78	Porphyry	2.5 —2.6
Felsite	2.65	Pyrite, FeS ₂	4.83—5.2
Galena, PbS	7.25—7.77	Quartz, SiO ₂	2.5 —2.8
Garnet	3.15—4.31	Quartzite	2.6 —2.7
Gneiss	2.62—2.92	Sandstone	2.0 —2.78
Granite	2.55—2.86	" Medina	2.4

ROCKS AND THEIR PROPERTIES

13

Sandstone	Ohio	2.2		Stibnite, Sb ₂ S ₃	4.5 —4.6
	Slaty		1.82		Syenite		2.27—2.65
Shale			2.4	—2.8	Talc		2.56—2.8
Slate			2.5	—2.8	Trap		2.6 —3.0
Sphalerite,	ZnS.		3.9	—4.2			

TABLE II.

Specific Gravity	Weight in Lb. per cu. ft.	Weight in Lb. per cu. yd.	Weight in Lb. per cu. yd. when Voids are				
			30%	35%	40%	45%	50%
1.0	62.355	1,684	1,178	1,094	1,010	926	842
2.0	124.7	3,367	2,357	2,187	2,020	1,852	1,684
2.1	130.9	3,536	2,475	2,298	2,121	1,945	1,768
2.2	137.2	3,704	2,593	2,408	2,222	2,037	1,852
2.3	143.4	3,872	2,711	2,517	2,323	2,130	1,936
2.4	149.7	4,041	2,828	2,626	2,424	2,222	2,020
2.5	155.9	4,209	2,946	2,736	2,525	2,315	2,105
2.6	162.1	4,377	3,064	2,845	2,626	2,408	2,189
2.7	168.4	4,546	3,182	2,955	2,727	2,500	2,273
2.8	174.6	4,714	3,300	3,064	2,828	2,593	2,357
2.9	180.9	4,882	3,418	3,174	2,929	2,685	2,441
3.0	187.1	5,051	3,536	3,283	3,030	2,778	2,526
3.1	193.3	5,219	3,653	3,392	3,131	2,871	2,609
3.2	199.5	5,388	3,771	3,602	3,232	2,968	2,694
3.3	205.8	5,556	3,889	3,611	3,333	3,056	2,778
3.4	212.0	5,724	4,007	3,721	3,434	3,148	2,862
3.5	218.3	5,893	4,125	3,830	3,535	3,241	2,947

Voids in Rock Blasted Under Water. Mr. E. C. Bowen (in *Engineering and Contracting*, Nov. 6, 1907) is authority for the following:

In Dredge Section 2 of the Ashtabula Dock Extension, Lake Shore & Michigan Southern Ry., the rock dredged was paid for by place measurement, there being 62,869 cu. yd. of rock so measured in this section. This was determined by careful soundings taken 6 ft. apart on ranges which were parallel lines spaced 6 ft. apart, both before and after dredging. The material dredged was shale rock which had been drilled and blasted, and which, after being dumped into scows, averaged about 25 lb. per piece in size.

The total amount dredged as measured in scows was 103,537 cu. yd. The amount of voids in the rock was, therefore, 39.3%. Excavation was paid for 6 in. below the required grade and no excavation was found by the soundings to have been carried below this level, which was 21.5 ft. below lake level.

A large amount of this material was used below water for filling the cribs forming the substructure of the docks and it was found to pack down very solidly. When exposed to air, however, it disintegrated rapidly.

Weight Affected by Moisture. Mr. Henry F. Alexander has called attention (in *Engineering and Contracting*, July 29, 1908) to the fact that the profits of a contract where stone is bought by the ton, may depend on whether the stone is weighed freshly quarried or well seasoned. He made a number of experiments,

in one of which a freshly quarried or "green" stone was weighed and then exposed to the sunshine and weather for 6 days.

It was then weighed and showed a loss of 9.7% in weight. A well seasoned rock was weighed and then immersed in water for 6 min. and then weighed, showing a gain in weight of $3\frac{1}{4}\%$. One immersed in water for 6 hours showed a gain of $3\frac{3}{4}\%$ in weight.

From the results of the above experiments and general observation, the following conclusions are drawn:

(1) Stone when freshly quarried is generally fully saturated with moisture and will not absorb more. It rapidly parts with its moisture when exposed to sun and weather, and consequently decreases proportionately in weight.

(2) The smaller the stones the more rapidly do they part with their moisture and, vice versa, when well seasoned they will absorb moisture much more rapidly when brought in contact with water.

(3) Large stones part with their moisture much more slowly, consequently when exposed to sun and weather for a short time there will not be so much difference in weight.

Measurement of Rock. Stone is sold by the cubic yard, cubic foot, ton, cord, perch, rod, square foot, square yard, square, etc. Building and monumental stone, especially the dressed product, is usually sold by the cubic foot or the cubic yard. Rough stone, as rubble, rip-rap, and stone for heavy masonry, is sold by the perch, cord, cubic yard, or ton. Flagstone and curbstone are sold by the square yard, square foot, and linear foot, and paving blocks are sold by the thousand blocks. Slate is sold by the square, which in the United States is a sufficient number of pieces of slate of any size to cover 100 sq. ft. with an allowance *generally* for a 3 in. lap. These facts the contractor and builder should know for he must often deal with quarry men who will not sell rock by the cubic yard.

Mr. S. W. Stratton, in *Engineering News*, gives the size of a perch as follows: In Oklahoma, North Dakota, South Dakota, and Ohio, fixed by law, at 25 cu. ft.; in Delaware it is $24\frac{3}{4}$ cu. ft. in walls, 27 cu. ft. when piled on the ground, 30 cu. ft. when in a boat, and $31\frac{1}{2}$ cu. ft. in cars; in Colorado it is $16\frac{1}{2}$ cu. ft. in mason work; in Philadelphia it is said to be 22 cu. ft., in Iowa and Nevada it is 25 cu. ft. Mr. McCollough says that a perch is $16\frac{1}{2}$ cu. ft. in California, Idaho, Washington and Montana. A perch is commonly taken as 25 cu. ft., but the original perch was a wall 12 in. high, 18 in. wide, and a rod long, making $24\frac{3}{4}$ cu. ft. The size of a perch probably varies in different localities within the same state.

A cord of wood is $4 \times 4 \times 8$ ft. = 128 cu. ft. but a cord of stone

is commonly $1 \times 4 \times 8 = 32$ cu. ft. A cord of stone in Chicago is 100 cu. ft. when measured in a wall.

The toise is also a measure of varying size. It is used in Canada. In Perth, Ontario, it is 36 cu. ft., in Hamilton, 70 cu. ft., in Toronto, 54 cu. ft., and in Montreal, 86 cu. ft. Trautwine gives the toise as 261.5 cu. ft.

Broken stone for fluxing is usually sold by the long ton, 2,240 lb. Crushed stone for ballast, concrete and macadam is usually sold by the cubic yard or by the short ton. Occasionally crushed stone is sold by the "square" of 100 sq. ft. by 1 ft., or 100 cu. ft., or by the bushel; $21\frac{1}{2}$ bu. usually equalling a cubic yard of about 2,700 lb. It is wise to define the word "ton" in any contract for a ton may mean 2,000 or 2,240 lb.

Riprap. It is occasionally specified that rock for riprap shall be paid for by the cubic yard after deposition; although it is a most unsatisfactory and uncertain way, for much of the rock may be lost in the mud or rolled away by the current. If the rock is delivered in scows it is a simple matter to estimate its weight by water displacement.

Settlement of Crushed Stone. Crushed stone for macadam, concrete or ballast shrinks in volume when hauled even a short distance in wagons or cars. The shrinkage ranges from about 5 to 14%. In wagon hauling about half the shrinkage occurs in the first 100 ft., and practically the entire shrinkage occurs in the first quarter mile. Further information on settlement is given in my "Handbook of Cost Data."

Overbreakage. Rock excavation is commonly measured in place before loosening and paid for by the cubic yard of actual excavation; but, in trench work and in tunnel work, if the contractor excavates beyond certain "neat lines" shown in the blue-prints, no payment is made, unless the specifications explicitly provide for payment for excavation beyond these "neat lines." In trench work, for example, a contractor often has to excavate from 6 to 18 in. below the grade shown in the blue-print, because it costs less to do so than to work too close to the grade and afterward break off projecting knobs with a bull-point or otherwise. The same is true of shallow excavation, or skimming work, in road construction and the like.

In examining specifications care should also be taken to note whether mention is made of rock slips or falls; for it often happens that after blasting to the neat lines a huge slide of rock occurs, possibly filling the entire excavation. Who is to stand the cost of removing this slide? If it is specified that the contractor shall, then he should study the dip of the rock and its character with this question of sliding in mind.

Mr. Emile Low makes the following statements concerning

overbreakage in a tunnel on the Clinch Valley Division of the Norfolk & Western Railroad. The prescribed cross-section of the tunnel was from 13 to 15 ft. in width and about 20 ft. in height, with the roof curved to a radius of 7.5 ft., giving an area of 263.66 sq. ft. or 9.76 cu. yd. per lin. ft. The breakage outside the prescribed cross-section was due to badly faulted structure. Hand drilling was used in all tunnels and some air drills were used in Big Bull and Little Tom tunnels. The contract price was \$3.25 per cu. yd. for tunnels less than 1,000 ft. long, \$3.50 per cu. yd. for tunnels more than 1,000 ft. long, and \$1.50 per cu. yd. for overbreakage. In ten tunnels, totaling 9,100 lin. ft., the overbreakage averaged 27% ranging from 16 to 44%, the least being in limestone and the most in shale.

Mr. G. A. Kyle gives statistics of the overbreakage in tunnels on the Alaska Central Railway. The overbreakage ranged from 2.3 to 27% and averaged about 12.1%. It does not appear that the overbreakage was paid for. The rock in all the tunnels was a hard slate, with the strata badly broken.

In a tunnel near Peekskill, New York, the contractor took out 10% more rock than he was paid for.

In a trench 6 ft. wide in hard New Jersey trap rock, the contractor had to drill $1\frac{1}{2}$ ft. below grade in this rock to ensure having no projecting knobs or rock. While it cost \$1.35 per cu. yd. to drill the 3.5 ft. for which payment was made, to this must be added nearly 30% or \$0.40 per cu. yd. to cover the cost of drilling the extra foot, for which no payment was received, making the total cost of drilling \$1.75 per cu. yd. of pay material. The explosives added another \$0.40 per cu. yd., making a total of \$2.15 per cu. yd. for drilling and blasting.

In driving the North Fork Tunnel on the Tieton project of the U. S. Reclamation Service, with machine drills, through a broken basaltic rock, the overbreakage was more than 25%. The tunnels should have run a little more than 1.5 cu. yd. per lin. ft., whereas they actually ran more than 2 cu. yd.

The overbreak in the construction of the Aspen, Wyoming Tunnel of the Union Pacific Railroad, driven through shale, amounted to about $1\frac{1}{4}$ cu. yd. per lin. ft. As the volume of neat excavation was 17.88 cu. yd. per lin. ft., the overbreak was 6.2%.

Mr. C. H. Richards states that tunnel No. 7 (north heading) of the Los Angeles Aqueduct was about 10 by 10 ft. in section, running 3.5 cu. yd. per lin. ft. The overbreakage was about 17%. The rock was close grained hard gray granite, seamy but breaking well.

In the Scranton Tunnel of the Lackawanna and Wyoming Valley Railroad the excavation and overbreakage were as follows:

	Natural Rock Section	Masonry Section	Timbered Section
Headings, Cu. Yd. per Lin. Ft.	4.71	7.04	8.38
Benches, Cu. Yd. per Lin. Ft.	9.00	11.00	12.00
Total, Cu. Yd. per Lin. Ft.	13.71	18.04	20.38
Overbreakage, Cu. Yd. per Lin. Ft.	1.00	1.13	1.18
Per cent. of overbreakage	7.30	6.30	5.80

The rock was variable and had a tendency to slab off or drop in small pieces.

Mr. Geo. C. McFarlane states that the overbreakage in open cut work on the Grand Trunk Pacific R. R., in rock where the cuts were 20 ft. wide at the bottom and the side slope was 3 in. to 1 ft., ranged from 10 to 40%.

Classification of Excavated Materials in Specifications. Despite all that has been written on this subject no entirely satisfactory way has been found to define in specifications the various classes of earth and rock. The solution of the problem has usually been sought in some kind of test. Thus, if a material can or cannot be plowed, or if it can or cannot be loosened by picks or bars, it is classified as earth or as rock.

Attempts at classification grew out of recognition of the fact that the cost of removal of each class of material varies, and that it is economic to eliminate that part of the contractor's "risk" incurred where no classification is attempted.

Mr. W. F. Dennis (*Trans. Am. Soc. C. E.*, March 6, 1907), proposed the following outline classification:

Excavation, excepting foundation pits for structures, elsewhere classified separately as foundation excavation, shall be either classified or unclassified, as may be determined at the time of the contract. If classified, the following classification shall apply:

Earth. Material which in its customary natural condition can be plowed — or is equivalent to a material which can be plowed — with a plow cutting a furrow 10 in. wide and 10 in. deep, drawn by a team of 4 horses, or mules, each having an average weight of 1,100 lb., and moving at a reasonable plowing speed, shall be classified as earth.

Loose Rock. The following shall be classified as loose rock: Earthy or mixed materials, not susceptible of plowing under the foregoing test; soft, fractured, disintegrated or other rocky material, soft or loose enough in its natural condition to be barred or picked apart by two men thus employed serving one man shoveling or loading by hand; solid rock in separate masses exceeding 1 cu. ft. each, and not exceeding $\frac{1}{2}$ cu. yd. The continuous or occasional use of explosives, at the contractor's option, shall not affect the classification, but it shall be governed solely by the test above set forth.

Solid Rock. The following shall be classified as solid rock: Rocky material in masses exceeding $\frac{1}{2}$ cu. yd., which cannot be broken apart, or displaced from its natural position, except by the use of explosives; and other rocky material which cannot be picked or barred apart by two men thus employed serving one man shoveling or loading by hand.

Where any excavation contains material of more than one classification, the relative percentage of each shall be determined by measurement and observation during the progress of the work.

I suggest that, instead of a furrow 10 in. by 10 in., a minimum number of cubic yards loosened per 10-hr. day by a 6-horse plow be specified. It seems a much better plan to specify in cubic yards, for the cubic yard is the unit of cost, and, after

all, the object is to secure some definite cost classification. A 10-in. by 10-in. furrow cut by four horses means nothing very definite, unless the amount of useful work be specified, either by naming the average speed of cutting or the average number of cubic yards loosened.

But why limit "earth" to such easy material as can be loosened by four horses? Ten-horse plows are very common in the West, where the art of driving with a jerk-line is practiced. There is a serious objection to the plow test wherever the work is to be done with steam shovels, and the objection is that it is practically impossible to apply the test in many cases. In a through cut, for example, the top 4 ft. of material may be loam, below which may lie an indurated clay of hardpan consistency. The steam shovel exposes a vertical face upon which no plow test can be made. Unless the 4 ft. are stripped, no plow test is of use on the surface. The bottom of the pit may be solid rock. The plow test is inapplicable under such conditions.

Many other conditions might be mentioned to show the difficulty of applying a plow test in a satisfactory manner. One more will suffice. In soil of glacial origin, lenses of hardpan are frequently encountered, surrounded by gravel, sand or shot clay. It is impossible to strip lenses in steam shovel work, for the purpose of using a plow test, and without stripping, no such test is possible.

The plow test, therefore, may serve in plow work, but it is practically useless in much of the work done by steam shovels.

The following definitions of classification according to tests have been suggested by various writers (*Engineering and Contracting*, Apr. 10, 1907):

By Mr. George L. Dillman:

"Solid Rock" shall include all rock, in ledges or masses of more than 1 cu. yd., which requires blasting.

"Loose Rock" shall include all detached masses of rock measuring more than 1 cu. ft. and less than 1 cu. yd.; also all shale, slate, soft sandstone and hardpan which can be removed with bar and pick, though blasting may be resorted to.

"Earth" shall include all material not classed above as solid or loose rock.

Class 1 shall include all material which can be broken and loosened by a standard No. 1 railroad plow into a condition in which it can be removed by standard railroad scrapers, the plow and the scrapers being drawn by power sufficient to develop their full capacities.

Class 2 shall include all material which cannot be broken and removed as specified for Class 1, but which can be loosened and removed by picks and bars, or by a standard steam shovel, rated at 50 tons or more, and without the use of explosives.

Class 3 shall include all material which cannot be removed without being broken and loosened by the use of explosives.

By Mr. M. S. Parker:

Class 1. All rock in solid beds or masses which can best be removed by blasting.

Class 2. Slate, shale, hardpan, cemented gravel, soapstone, soft sandstone, and all other rock loose enough to be removed without blasting, although, to facilitate handling, blasting may occasionally be resorted to.

Class 3. All material which in its natural condition can be plowed with a plow cutting a furrow 10 in. wide and 10 in. deep, drawn by four horses or mules, each weighing not less than 1,100 lb., and moving at a reasonable plow speed.

Mr. H. P. Bell suggested the following:

There should be four classifications of material as follows: (1) Solid Rock; (2) Loose Rock; (3) Earth; (4) Hardpan or cemented material.

(1) All material weighing over 140 lbs., per cu. ft., in situ, for the economical removal of which within reasonable time explosive is required, shall be paid for as solid rock.

(2) All material weighing over 140 lbs. to the solid cu. ft. in situ, for the economical removal of which, within reasonable time, explosive is not necessary, shall be paid for as loose rock.

(3) All material of which the weight per solid cu. ft. in situ is less than 140 lbs., for the economical removal of which, within reasonable time the use of explosive is not necessary, shall be paid for as earth.

(4) All material of which the weight per solid cu. ft. in situ is less than 110 lbs., for the economical removal of which, within reasonable time, the use of explosive is required, shall be paid for as hard pan or cemented material.

Mr. James H. Bacon in a paper read before the American Society of Engineering Contractors on Jan. 10, 1910, suggested the following:

Classification of Excavated Material. Following up the general principles enunciated above and especially that which requires that "difference of opinion" shall be eliminated, it is clear to the writer that there should be only three classes of excavated material, not including excavation under water, or excavation or removal of any artificial work such as old masonry, etc. These three classes should be: (1) Solid rock. (2) Loose rock. (3) Common excavation.

Common Excavation. In many specifications the dividing line between common excavation and loose rock is determined by the "plow test": this test should be discarded entirely as unsatisfactory. There are thousands of acres, which may in the future be crossed by railways, where the material to be moved has not the faintest resemblance to rock and where no sane man would attempt to break ground with a plow. The plow test is impossible, and the logical result, if the specifications provide this test, is that such material must be classed as loose rock.

Many of the western roads have discarded this test and specify that "all material not classed as loose or solid rock shall be common excavation." The companies using this specification specify that loose rock shall be any rock that can be removed without blasting, although blasting may occasionally be resorted to, or any rock in detached masses varying in size between given limits, and that solid rock shall be rock in masses that cannot be removed without blasting. It will be noticed that these specifications require a definition of the word "rock."

The writer submits the following specifications for the classification of excavated material:

In these specifications the word "rock" shall be interpreted to mean any portion of the consolidated material forming the crust of the earth which has a greater volume than 1 cu. ft. Unconsolidated materials, such as sand, grave, clay, hard pan, are not rock under these specifications.

Solid Rock. All rock in masses that cannot be removed without drilling and blasting. All boulders or detached pieces of rock that measure 1 cu. yd. or more in volume.

Loose Rock. All rock which is loose or soft enough to be removed without blasting, although blasting may, at the option of the contractor, be occasionally resorted to. Detached pieces of rock measuring in volume from 1 cu. ft. to 1 cu. yd.

Common Excavation.— All material not solid or loose rock. The sizes specified for boulders and detached pieces are of course subject to be changed according to varying circumstances. No tests are recom-

mended, as the writer believes that they would serve no useful purpose and tend to cause complications.

Excavation Under Water. This classification should be applied to all channels and pits under water which cannot be drained by ditching. The price or prices paid should be per cubic yard and should cover all material and labor, including coffer dams, necessary to do the excavation required. There should be at least two classes — *i. e.*, with and without coffer dams. In many cases special specifications would be necessary.

CHAPTER II

METHODS AND COST OF HAND DRILLING

Kinds of Hand Drills. Drilling holes in rock by hand may be effected in three principal ways: (1) By a rotary drill or auger; (2) By a churn-drill; (3) By a hammer-drill, or jumper drill, struck with a hammer. A rock auger operated by hand is sometimes used in very soft rock or coal. Drilling machines on which the drill is operated by means of gears and a crank turned by hand, or by the fall of a weight raised by hand, are occasionally used under special conditions, but more properly belong in the class of machine drills, and will therefore not be discussed in this chapter.

A churn-drill, as its name implies, is raised and allowed to drop, or is hurled against the rock. For shallow holes of small diameter it is necessary to give a churn-drill additional weight, which is done by welding a ball of wrought iron to the center of the drill shank, making a *ball-drill*. A ball-drill is usually provided with a cutting bit at each end and is operated by one man.

For deep drilling, that is, for holes more than about 3 ft. deep, an ordinary churn-drill is used, operated by one man for shallow work, two men for deeper work and three or even four men for very deep holes where the weight of metal becomes considerable. Churn-drills are made by welding a piece of tool steel, about 18 in. long, to a long piece of bar iron or to a piece of 1.5 in. pipe.

To facilitate lifting a long churn-drill a cross-piece or arm is temporarily fastened to the drill with wedges. One of these cross-pieces is provided for each pair of men.

The Theory of Drilling. A hammer-drill, often called a "jumper," although it is not jumped, may be driven by one man, who holds the drill with one hand and strikes it with a hammer in the other hand. In this way holes up to 3 ft. in depth can ordinarily be drilled cheaper than when one man holds the drill while two men strike. But in discussing the relative economy of one-hand drilling as compared with two-hand drilling, authorities appear to have ignored the factor of depth of hole. As the hole grows deeper the advantage of a heavy hammer becomes more and more apparent; but a heavy hammer

requires a man's two arms to swing it. A large percentage of the energy of the blow is always consumed in compressing the head of the drill, the shank of the drill and the hammer itself, leaving at best only a small percentage of the blow to overcome the cohesion of the rock. In pile driving in soft mud about 65% of the energy of the hammer is lost in heating the pile-head, etc., leaving only 35% to overcome the friction of the mud on the pile; and in an analogous way much of the energy of a hammer in the hands of a driller is lost. The longer the pile and the lighter the pile hammer, the greater the loss of energy and the less effective the blow; so in drilling there comes with increased length of drill a decreased percentage of energy that reaches the bit. In fact, if the drill be made long enough, the blow of a one-hand hammer has absolutely no effect in cutting the rock, although a two-hand hammer still has effect.

The churn-drill in the hands of a skilled driller is the most effective type of hand drill for vertical holes; and a little theory is not without its practical value in seeking the reason for the effectiveness of the churn-drill. As before stated, much of the energy of the blow of a hammer is lost in the form of heat at the head of the drill. This loss does not occur with the churn-drill. Moreover, the element of time involved in wedging off a chip of rock also appears to be an important factor. When the cutting edge, or wedge, of a churn-drill first reaches the bottom of the hole, after its descent, the work of wedging off a rock chip begins. A wave of compression travels up several feet of steel before the last ounce of steel in the drill bar has done its work. Obviously it must take about 12 times longer for a churn-drill 6 ft. long to do its wedging work than for a hammer 6 in. long to do its work. This comparatively gradual and steadily increasing wedging action of the churn-drill theoretically should be more effective than the more sudden action of a hammer-drill; and, as a matter of fact, it is.

It takes some skill to start a hole with a ball-drill and to keep it plumb; but the time spent in acquiring this skill is repaid many times over if quarry operations with hand-drills are to be moderately extensive.

The Effect of the Size of the Hole upon the speed of drilling appears never to have been carefully determined. One authority says that to double the diameter of the hole decreases the speed of drilling by one-half. Another authority thinks that doubling the diameter divides the speed by four. According to the first authority, if a man could drill 12 ft. of 1-in. hole in a shift, he could drill only 6 ft. of 2-in. hole in a shift. According to the second authority, only 3 ft. of 2-in. hole could be drilled per shift. As bearing upon this point the reader is referred to

some experiments with different sizes of bits used in machine-drilling tests, an abstract of which appears on page 216.

Effect of the Inclination of the Hole. In drilling by hand it is evident that the blow of a hammer is most effective when directed vertically downward, less effective when directed horizontally and least effective when directed upward. The only careful experiments to determine the relative speeds of drilling at different angles appear to be those of Prof. Hofer. The time required to drill 1 inch of hole in graywacke (a slate, or grit, or conglomerate?) with a hammer-drill, with holes at different angles, was as follows:

85° down (nearly vertical)	152 sec.
60° "	183 "
52° "	241 "
27° "	282 "
2° "	257 "
0° (horizontal)	323 "
24° up	345 "

From which it appears that, at these rates, 16 ft. of vertical hole or 7.5 ft. of horizontal hole would be drilled in 8 hr. This shows one of the several reasons why rock excavation in a tunnel by hand is more expensive than open cut excavation; and it indicates the importance of stating the angle of the drill hole when giving data on hand drilling. Some data given by Jarolimek on drilling dolomitic limestone roughly confirm the above:

60° down	193 sec.
10° up	287 "
45° up	345 "

As bearing upon this point of the angle at which holes are drilled some old data may be quoted from Schoen's "Der Tunnelblau" (1874). Schoen gives the comparative number of cubic yards of material excavated in an open cut and in a railway tunnel, by hand work, 8-hr. shift, and using black powder:

	Cu. yds per man.	8 hr. Tunnel	Open cut
Soft ground	8.5	16.2	
Ground loosened with pick	5.3	7.2	
Ground loosened with gad	3.2	6.5	
Quarried rock	1.1	2.6	
Quarried and blasted rock	0.64	2.0	
Blasted rock	0.34	1.3	

In considering the effectiveness of vertical hole drilling it should be remembered that a hole which can be kept partly full of water can ordinarily be drilled faster than a dry hole, and holes that "look up" are necessarily dry, unless, as is rarely done, a jet of water is kept playing into the hole. The water in a down hole takes up and holds in suspension the fine particles of rock, leaving a clean face of rock at the bottom of the hole for the bit to work upon. One authority (Aitken) says

that in quarrying trap rock the use of water in drilling reduces the time of drilling a hole by 30%. In certain soft shales, however, up holes are drilled faster than down holes, for the dry powdered shale runs out of the up hole; but in a down hole the shale powder makes a stiff mud with the water and cushions the blow of the bit.

Hammer Drilling. The common weight of hammer for one-hand drilling is 4.5 lb.; for two-hand or three-hand drilling, 10 lb. The striking face must be flat or slightly rounding, and smaller than the stock of the hammer. The hole is started on a solid and squared surface with a short drill, for the longer the drill the less effective the blow. Light blows are struck at first. The bit is turned one-eighth of a revolution after each blow to insure keeping the hole truly circular. But in spite of this precaution most hand-drilled holes are three-cornered, or "rifled." This rifling is not very objectionable in ordinary excavation work, but in quarrying square blocks for masonry it is decidedly objectionable because the rock tends to split in the directions of the three angles of the drill hole upon blasting.

A leather or rubber washer is slipped over the drill and kept close to the hole to prevent splashing of the sludge into the eyes of the drillers. Water is poured into the hole, an operation which is called "tending chuck." The water holds the powdered rock in suspension, forming a sludge which must be removed from time to time. For cleaning out this sludge a scraper or "spoon" is used in shallow holes. A spoon is $\frac{1}{4}$ to $\frac{1}{2}$ -in. rod provided with a disc at each end, the discs being of different diameters to correspond with the size of the hole at different depths. A spiral hook, or drag-twist, is also used for wiping the hole with hay before charging with black powder. A wooden rod, split or broomed at the end is often used for cleaning out a hole. The broomed end of the rod is dipped into the sludge, and when removed from the hole is struck upon the rock to remove the sludge adhering to the broomed end.

For two-hand or three-hand hammer drilling a bit of $1\frac{1}{4}$ to $1\frac{1}{2}$ in. is commonly used for the starter, and the extreme depth of hole is ordinarily not over 6 or 8 ft.; for, as previously shown, the effectiveness of the hammer blow falls off rapidly with increased depth. One man holding the drill and two men striking (three-hand drilling) form the most effective gang for railway tunnel work, also for quarry work where men used to churn drilling are not available.

One-Hand vs. Two-Hand Drilling. In the metal mines of the West skilled miners ordinarily prefer one-hand drilling when working by contract. The miner holds the drill with one hand

and wields the hammer with the other. In very hard rock two-hand drilling is said by Drinker to be slightly (15%) cheaper than one-hand drilling; but in soft rock he says one-hand drilling is 20 to 30% cheaper than two-hand drilling. Where one man strikes, while the other man holds the drill, the heavier hammer used makes it possible to drill a larger and deeper hole with economy. Where there is room for one man to hold while two men strike, the economy is greater still. In American railway tunnel work two or three-hand drilling is much more commonly seen than one-hand drilling.

Rapid drilling by hand is not accomplished by use of heavy hammers and forceful blows, but by hammers of proper size handled by men who know how to strike the blow that will cause the drill to cut and keep the bottom of the hole clear so that the drill is working on solid rock and not on a lot of loose fragments. This is an art and is only learned by experience.

Churn Drilling. For drilling vertical holes, churn drilling is cheaper than hammer drilling. The only exception to this statement is the drilling of plug and feather holes only a few inches deep; but even then a skilful quarryman using a ball-drill will churn down a small hole with greater rapidity than a one-hand hammer driller. Almost any tyro, however, can drill plug holes with a hammer drill; but it takes skill to start a hole with a ball-drill.

For deep holes in soft rocks, like shale, a churn-drill, in the hands of two or more men, is the best hand tool in use. By building a light staging over the hole, as many as six men may operate one drill; three men on the ground and three on the staging; but this is seldom done, except where deep soundings are being made to determine the nature of strata. For breaking up shale for steam shovel work holes 20 ft. deep are commonly drilled. A pit about 18 in. deep and 3 ft. in diameter is often dug in the earth overlying the rock, and in the center of this pit the drill hole is started. When the hole is well started the men sit on the sides of the pit with their feet in the bottom. I have never been able to see the philosophy of this pit digging, for a circular wooden stool serves as well as the ground to sit on; and, unlike the pit, it can be used over and over again. Moreover, it is an open question whether churn drillers should be permitted to sit down, for in that position their arms and shoulders do the entire work, whereas when standing their back and thigh muscles aid in lifting the drill. When more than two men are operating a drill it is practically impossible to use the back and thigh muscles; hence the efficiency

of each man is greatly reduced when a third man takes hold of the drill, unless the third man stands on a scaffolding above the heads of the two men on the ground.

A round drill rod $\frac{3}{4}$ in. in diameter weighs 1.5 lb. per ft. of length; a 1 in. rod, 2.65 lb.; a $1\frac{1}{4}$ -in. rod, 4.15 lb. per ft., and a $1\frac{1}{2}$ -in. rod 6.0 lb. per ft. It is well to bear these weights in mind when considering the work of churn drilling, for it seems such a little thing to add only $\frac{1}{4}$ in. to the diameter of drill stock, while in fact the addition adds greatly to the work of lifting the drill. Up to a certain limit, weight is desirable in drilling with a churn-drill; for the drill is not hurled, but allowed to drop freely (unless it is a ball-drill), and does its work by virtue of its weight and velocity. But for every class of rock there is a limit to the weight of a churn-drill beyond which there is an actual loss of efficiency, due to the greater number of drillers required to lift the drill.

Cost of Hammer Drilling. We have seen that the diameter of the hole, the angle at which the hole is driven and the presence or absence of water in the hole all effect the cost of drilling by hand. We have also seen that the method of drilling with hammer-drills or with churn-drills is an important factor in the cost. Obviously the character of the rock is the most important factor; but unfortunately very few reliable records of cost of drilling in different kinds of rock are to be found. From some observations on hammer drilling, with a $1\frac{1}{2}$ -in. starting bit I have found that where one man is holding the drill vertically and two men are striking, the rate of drilling a 6-ft. hole is as follows:

	Ft. in 10 hr.	Cost per ft.
Granite	7	\$0.75
Trap (basalt)	11	0.48
Limestone	16	0.33

The cost is based upon a wage rate of \$1.75 per 9-hr. day per man; and does not include the cost of sharpening drills, which may be taken at 5 to 8 ct. per ft. more.

I have found that a man drilling plug and feather holes in granite, each hole being $\frac{5}{8}$ in. diam. by $2\frac{1}{2}$ in. deep, will average one hole in $3\frac{1}{2}$ to 5 min., including the time of cleaning out holes, and the driller strikes about 200 blows in drilling the hole, at the rate of 40 to 60 blows per minute. No water is used in drilling these shallow holes, for the dust is readily and quickly cleaned out with a little wooden spoon. In 8 hr. of steady work about 100 holes can be drilled, which is about 21 ft. of $\frac{5}{8}$ -in. hole. But in plug and feather work part of the time is spent in selecting rock, driving the plugs, etc., and allowing 1 min. for plug and feathering, and 5 min. for drilling;

60 or 80 holes drilled and plugged and feathered is generally counted a fair day's work.



Fig. 2. Plug Drill.

I am indebted to Mr. John B. Hobson for the following data of hammer drilling in a British Columbia mine: Rock was augite diorite and firm red porphyry; starting bit, $1\frac{3}{4}$ in.; finishing bit, $1\frac{1}{4}$ in.; $\frac{7}{8}$ in. steel; holes, 6 ft. deep; 8-lb. hammer. Two miners (one holding drill and one striking) averaged 14.8 ft. per 10-hr. shift. With wages at \$2 a day the cost was nearly 28 ct. per ft. of hole.



Fig. 3. Plug and Feathers.

On mica-schist, near Mt. Vernon, a foreman told me that two strikers and a holder would drill two 7.5 ft. holes in 10 hr. (15 ft. of hole) the finishing bit being $1\frac{1}{4}$ in., starting bit $1\frac{3}{4}$ in.

Mr. Frank Nicolson states that in mining chalcopyrite in magnesian limestone at St. Genevieve, Mo., a day's work for a striker and a holder was 12 ft. of hole drilled. The drill had $1\frac{1}{4}$ -in. starting bits, $\frac{7}{8}$ in. octagon steel being used. Wages in 1882 were only \$1.35 for miners doing this work, the shift being 10 hr. long. It cost \$6.50 per lin. ft. to drive a 4 x 6 ft. drift, using 40% dynamite.

In driving the Hoosac Railway Tunnel in 1865 (see Drinker) through gneiss and tough mica schist, 2-ft. holes were drilled in the headings, using $1\frac{3}{8}$ -in. starting bits, and each driller averaged only 3.5 ft. of hole per 10-hr. shift. From 7 to 13 bits were dulled in drilling each hole. Drillers were paid \$2.25 a day. Black powder was used in blasting, which accounts for the fact that the holes were large in diameter and shallow.

In driving the Glasgow water works tunnels in 1856-1857 (see Simms), through very hard mica schist, drill holes 20 in. deep and 1.25 in. in diameter were drilled, a new bit being required for each inch of hole. The time required to drill each hole is stated to have been 1.75 hr., but no statement is made as to the number of men engaged—presumably two or three on each hole.

Hilsgen states that Swedish iron miners each average 5 ft. of hole a day in medium rock; single-handed drilling; holes 2.5 ft. deep; but he does not give the size of bits—a serious omission.

In sewer trenches in limestone rock at St. Louis, hand drills

were used to break up a ledge or strata. The bits were 1.75 in. in size, and one man drilled about 10 lin. ft. of hole per 8 hr.

On railroad work, Mr. L. N. Jenssen (see page 635) reports the average work of a drill gang in extra hard and tough granite as 14 ft. per day. A gang consisted of 2 strikers and 1 drill holder and wages were \$2.00 to \$2.25 per day.

On the Nesquehoning Railway Tunnel (Drinker) driven in 1870 through the conglomerates and shales of Carbon county, Pa., drillers received \$2.25 and laborers \$2.00 per 8-hr. shift. The cost of hand drilling was 56 ct. per ft. of hole, of which 6 ct. was for steel and sharpening. Machine drilling in this same material cost 14 ct. per ft. of hole, including repairs to drill, etc., but not including interest and depreciation.

In excavating hard porphyry for the rock-fill dam at Otay, Cal., Mr. W. S. Russell states that a good day's work for three men drilling (one holding and two striking) was 6 to 8 ft. of hole, costing about 80 ct. per ft. of hole drilled. The holes were drilled 20 ft. deep vertically and sprung. This was an unusual depth of hole for hammer drilling, and accounts for the high cost per foot. It shows also how un-economic is hammer drilling in deep vertical holes compared with churn drilling.

In driving a small (3 x 4.5 ft.) tunnel through tough sandstone one driller averaged 4 to 5 holes, each 1½ ft. deep, per 8-hr. shift, using a ⅞-in. bit for the starter; and, upon cleaning up, the advance was 1 ft. per shift for one man. Each hole was charged with half a stick of 75% dynamite.

In *Mines and Minerals* (1911), Mr. Charles W. Henderson gives the following data on hammer drilling in a phonolitic dike near Cripple Creek, Colorado.

In driving small tunnels, each driller averaged 1 ft. per hr., or 8 ft. per day, the holes being 2.5 ft. deep.

Cost of Hand Drilling in Granite. Mr. George C. McFarlane (in *Engineering and Contracting*, Nov. 27, 1907) is authority for the following data on work done by him for Grand Trunk Pacific R. R., in Canada.

The following are some records of hand drilling:

One gang of three men, in drilling 10 to 14-ft. holes in dark hornblende, averaged 29 ft. per day.

In drilling red granite, 20 ft. is about the average per day.

In trap and diabase rock, 18 to 19 ft. is an average day's work.

In drilling block holes, a smaller number of feet is drilled per day. A record for six days for one gang on block-hole work was: Monday, 1 hole 36 in. deep; 1 hole 45 in. deep; 8 holes from 5 to 12 in. deep: total driven, 11 ft. 7 in. Tuesday, 1 hole 22 in.; 1 hole 18 in.; 4 holes 6 to 9 in.; total, 5 ft. 11 in. Wednesday,

1 hole 36 in.; 1 hole 22 in.; 1 hole 17 in.; 5 holes 6 to 12 in.: total, 9 ft. 9 in. On Thursday the drilling done was for holes to square up bottom of cut, there being 5 in all; 1 hole was 68 in.; 1 hole 50 in.; 1 hole 24 in.; 1 hole 40 in.; 1 hole 28 in.; total, 17 ft. 6 in. On Friday 11 holes from 6 to 16 in. were driven. Saturday, 1 hole 44 in.: 1 hole 30 in.: and 7 holes from 6 to 9 in.; total, 10 ft. 3 in. This gives a total of 62 ft. 8 in. in 49 holes, or an average depth of about 15 in.

For sharpening the steel a blacksmith and a helper were employed, and a "nipper" to carry the steel back and forth from the cut and shop. For sharpening the steel for 5 gangs of drillers, who put down 2,142 ft. in a month, we have the following cost:

Blacksmith, 25 days at \$3.50	\$ 87.50
Helper, 24 days at \$2.00	48.00
Nipper, 24 days at \$2.00	48.00
12 sacks coal	12.00
	\$195.50

This gives an average cost of sharpening of about 9 ct. per ft. of drill hole.

This gives us a total cost of drilling and sharpening drills for the examples given as follows:

Dark hornblende (deep holes) 29 ft. drilled per day —	
Drilling, per ft.	\$0.23
Sharpening, per ft.	0.09
Total, per ft.	\$0.32
Red granite (deep holes), 20 ft. drilled per day —	
Drilling, per ft.	\$0.34
Sharpening, per ft.	0.09
Total, per ft.	\$0.42
Red granite (shallow block holes), 10 ft. 3 in. drilled per day—	
Drilling, per ft.	\$0.65
Sharpening, per ft.	0.09
Total, per ft.	\$0.74
Trap and diabase (deep holes), 18 to 19 ft. drilled per day —	
Drilling, per ft.	\$0.35
Sharpening, per ft.	0.09
Total, per ft.	\$0.44
Average of 5 gangs, 18 ft. drilled each day —	
Drilling, per ft.	\$0.37
Sharpening, per ft.	0.09
Total	\$0.46

This gives an average of 19 ft. at a cost of 47 ct. per ft. for drilling and sharpening steel. This includes both deep and shallow holes.

Cost of Hand Drilling in Gneiss. The following is from *Engineering and Contracting*, Oct. 2, 1907. In excavation made in building a new railroad in a mountainous section, the rock was hard but not very seamy. Three men worked in a gang; two

driving steel and the third holding, nine pound striking hammers being used. Eight of these gangs worked on the job, and some little rivalry existed as to the depth of hole driven in ten hours. The average work done by these gangs was as follows:

2 gangs drove 12 ft. per day =	24 ft.
4 gangs drove 14 ft. per day =	56 ft.
1 gang drove 16 ft. per day =	16 ft.
1 gang drove 17 ft. per day =	17 ft.

Total at 14.1 per gang = 113 ft.

The total cost for drilling per 10-hr. day was as follows:

24 drillers at \$1.50	\$36.00
4 nippers at \$1.00	4.00
Blacksmith	2.50
Helper	1.50
Charcoal burner	1.50
Borax and salt10
Total per day	\$45.60

The cost per lineal foot in detail was:

Drilling	\$0.318
Nipping	0.035
Blacksmithing	0.050
Total	\$0.403

One nipper carried steel to and from the blacksmith shop for two drilling gangs, the distance being less than a half mile.

The nippers also carried water for the drillers, the work of the latter being only to drive the steel and clean the sludge from the holes.

The starters or jumpers had a bit of 2 in., and the holes, which were from 6 to 16 ft. deep, were finished off with bits from 1½ in. to 1¼ in. The steel used for drills was 1¼ in. octagonal.

Most of the excavation was side hill work, and holes were spaced at various distances to suit the conditions for each blast; hence definite idea as to the cost of drilling per cubic yard cannot be given. The record here given is for holes 6 ft. or more in depth. With shallow holes, such as are needed for "blocking," fewer feet per day were driven, as time was lost by the drilling crew moving from place to place, and also in starting a larger number of holes.

Cost of Hand Drilling in Mica Schist. In drilling for a small rock cut on Manhattan Island, New York, the work was done by hand. Two strikers and a holder averaged 15 ft. per 10-hr. day. Each hole was 7½ ft. deep, the starting bit being 1¾ in. and the finishing bit 1¼ in. The rock was a tough mica-schist. Each man averaged 5 ft. of hole per day, which is equivalent to 40 ct. per lin. ft. when wages are \$2 a day. The holes were spaced very close together, averaging only 2½ ft. apart. Hence it required 3 ft. of drill hole per cu. yd. excavated, which, at 40 ct. per lin.

ft., made the cost \$1.72 per cu. yd. for drilling alone. The job was being done on a percentage basis, which may account, in part, for the fact that the contractor permitted such close spacing of the drill holes. As a matter of fact, small as the job was, it would have paid handsomely to have installed a steam drilling plant.

The cost given does not include the cost of sharpening the steel or carrying it to and from the blacksmith shop.

Compare this cost of 40 ct. per ft. in rock, where machine drills will work well as a rule, with the cost in rock where drills wedge very often, as in the following work.

Comparative Cost of Hand and Steam Drilling. In constructing a sewer on Princess St. in Hamilton, Ont., hand and steam drilling were compared in a trench 24 ft. deep in shale rock. The material was a peculiar red shale formation in which the drills wedged and choked very rapidly. This was the principal reason for the favorable showing of the hand work.

Item	Steam	Hand
Length of hole	512	270
Labor at 20 cts. per hour, per ft.....	\$0.139	\$0.14
Engineer cost per ft.	0.017	0.00
Coal cost per ft.	0.022	0.00
Total cost per ft.	\$0.188	\$0.14

The above information is given by A. F. Macallum, City Engineer, Hamilton, Ont., in *Engineering and Contracting*, Sept. 29, 1909.

Comparative Cost of Hand and Machine Drilling in Tunneling. Where the location of work is difficult of access, and the expense of bringing machinery to the site prohibitive, drilling is often done by hand. In the construction of the Haversting Tunnel, Norwegian State Railways, it was estimated that the cost by hand boring as compared with the cost of machine boring effected a saving of \$54,000. This tunnel was 7,550 ft. long with a cross-section of 270 sq. ft. and was driven from both ends by hand in 5.5 years. The men worked in 2 shifts of 10 hours. The rock was chiefly gneiss with feldspar and quartz. See *Trans. Inst. C. E.*, year 1909.

On the other hand, under the usual conditions and on work of large extent, machine drilling is far more rapid. In the *Bulletin of the International Railway Congress*, 1910, it is stated that "from an investigation of 20 long tunnels it is seen that the average ratio of advance by machine and by hand is 4 to 1. When the ratio is 3 to 1, as in rock of medium hardness, a cubic yard taken out by hand costs $\frac{3}{4}$ of one taken out by machine."

Certain portions of the Dulzura Conduit of the Southern California Mountain Water Company, were so difficult of access as to

make hand drilling necessary. This work is described by Mr. M. M. O'Shaughnessy in *Engineering News*, 1908.

Tunnel No. 1, 1,200 ft. long, in very hard syenite and quartzite, was driven entirely by hand drilling, because its peculiar location would have made the delivery of water and machine supplies very difficult. The tunnel cross-section is approximately 6 ft. wide and 6 ft. high. The track, cars, powder, fuse, caps, and candles were furnished by the contractor, and the labor was sublet to miners at \$15 per ft. These miners were excellent hand drillers and worked in 8-hr. shifts, allowing 4 hr. after shooting for the powder smoke to disperse. Two men in one 8-hr. shift usually drilled 10 holes each 1 ft. long equal to 10-ft. of hole. The drilling was done single-handed with 4-lb. hammers. There was used per ft. of tunnel about 4-lb. of powder, 2-lb. of candles, 13.3 caps and 30 ft. of fuse. The drills used were $\frac{7}{8}$ -in., and each shift drilled about 100 drills. The "ammunition" cost a little less than \$2 per foot of tunnel. Ammunition on other hand-drilling in softer granite done by the water company cost as follows per foot of tunnel:

39 ft. fuse at \$5 per 100	\$0.195
13.3 caps, 60 ct. per box	0.080
15.3 lb. powder, 14 ct. per lb.	1.142
1.4 lb. candles, 12 ct. per lb.	0.168
	<hr/>
Cost of ammunition per tunnel foot	\$2.585

Most of the other tunnels were done with air drills operated with a 50-hp. and 75-hp. gasoline engine and compressor. In 24 hr. a round of 12 to 14 holes about 4½ ft. deep was drilled. The miners were paid \$5 per man per round, with a bonus for all over 100 ft. per month. Muckers received \$1.50 per ft. Seventy-five pounds of 40% giant powder was used per round, averaging 18.75 lb. per ft. The two compressors consumed 110 gal. of gasoline per day costing \$3 per ft. The cost to the contractors was therefore about as follows per foot of tunnel:

80 ft. of fuse	\$0.400	
18.75 lb. powder	2.625	
13.3 caps	0.080	
25 candles	0.300	
	<hr/>	
Ammunition per ft.		\$3.405
2 miners at \$5 for 4 ft.	\$2.50	
Mucking	1.50	
Gasoline	3.00	
Engine labor and incidentals	2.00	
Truck equipment	1.00	
	<hr/>	
Labor, power, etc.		10.000
Total cost per foot		<hr/> \$13.405

Speed of Hand Drilling in Railroad Work. In the construction of the Rocky Mountain Division of the Canadian Pacific

Railway during the season of 1884, the cost of drilling as given by Mr. G. C. Cunningham in *Transactions, Institute Civil Engineers* (1886) was as follows:

In open cut, hard crystallized limestone, drilling was done by hand, owing to the impossibility of bringing in machinery over the roads. Two men striking and one holding made but 9 ft. of 1.5-in. hole in 10-hr. in the hardest rock, but averaged 16 to 18 ft. in rock of average hardness. Tunnel No. 1 in hard crystalline limestone, much fissured and broken, was driven 6.5 ft. per week, working night and day. The following particulars are given for tunnels No. 3 and 4 in slate shale: Gang at heading-face, 1 foreman, 1 drill-man, 1 dump-man, 2 drivers, 11 shovelers; 11-hr. shifts; av. depth of hole, 3.5 ft.; diameter of hole, 1.5 in.; av. progress in 24 hr., 3 ft. 3 in.; average quantity of material moved per man in 24 hr., 1.62 cu. yd.

Comparative Cost of Hand and Machine Drilling in Mining.

In an article on the gold-mining industry of the Witwatersrand, Transvaal, in *Transactions, Institute Civil Engineers* (1911), Mr. F. H. Hatch gives the result of the stope drill competition of 1909:

The width of stopes was 24 to 45 in., and the winning machines were reciprocating percussion type drills, thus reversing the results of the competition of January, 1908, when first place was won by a hammer drill.

Machine	Depth drilled, ft.	Av. drilling speed, in. per min.	Cost per foot drilled, ct.
Holman, 2 1/2 in.	12,779	0.742	19.5
Siskol	14,083	0.818	19.8
Holman, 2 3/4 in.	11,744	0.682	21.8
Chersen	11,781	0.684	23.9

Mr. Hatch further states the cost of hand drilling under these conditions to be rarely less than 26 ct. per ft. The tonnage broken is 6 to 5 in favor of machines, whereas the cost of explosives is 6 to 5 in favor of hand work.

Oscar Guttman says the average work per hour that can be done by hand drilling and machine drilling may be taken as follows:

Kind of rock	Hand Drilling, in. per hr.	Machine drilling, in. per hr.
Iron stone	7	36
Granite	16 to 24	80
Greywacks	20	80
Slate	24	100
Limestone and Dolomite	28	100
Quartz (mild)	32	120

The hand drill holes were 1 in. in diameter and the machine drill holes were 2.5 to 3 in. in diameter at the mouth.

Mr. C. W. Smith is authority for the statement that on the

construction of the Roosevelt Dam, 8,500 ft. of hole was drilled by hand at a cost (including the sharpening of steel) of 92 ct. per ft.; 785 ft. of hole was drilled by machine at a cost of 36 ct. per ft., to which must be added 3 ct. per ft. for sharpening steels.

TABLE III. SUMMARY OF SPEEDS OF HAND HAMMER DRILLING

Character of Work	Kind of Rock	No. of men per drill	Diameter of Bit, in.	Depth of holes, ft.	Ft. per hr.
Railroad cut...	Hard crystallized limestone	3	1.7
Open cut	Mica schist	3	1 1/4	7.5	1.5
Side hill cut...	Gneiss	3	2	6-16	1.41
Open cut	Hard porphyry	3	...	20.	0.6-0.8
Railroad cut...	Very hard granite	3	1.4
	Dark hornblende	3	1 1/4	12	2.9
Railroad cut...	Red granite	3	1 1/4	12	2.0
	Trap, diabase	3	1 1/4	12	1.85
Block holes	Red granite	3	1 1/4	Av. 1.25 0.5-4.0	1.04
Trench	Limestone	1	1 1/4	...	1.25
Tunnel	Gneiss, tough mica schist.	1	1 1/4	2.0	0.35
Tunnel	Very hard mica schist	2-3	1 1/4	1.67	1.00
Tunnel	Tough sandstone	1	0 3/4	1.5	1.19
Tunnel	Very hard syenite and quartzite	2	...	1.0	1.25
Mine	Augite diorite, firm red porphyry	2	1 1/4	6.0	1.48
Mine	Chalcopyrite, limestone	2	1 1/4	...	1.0
Mine	Medium rock	1	...	2.5	0.5
Tunnel	Compact phonolite dike	1	1 1/4	2.5	1.0
Shaft	Compact phonolite dike	1	1 1/4	2.5	1.2

Cost of Churn Drilling. I am indebted to Mr. W. M. Douglass, of the firm of Douglass Bros., contractors, for the following data on drilling with churn-drills, for railroad work in western Ohio. Three drillers were used for putting down the first 18 ft. of hole in blue sandstone the first day (10 hr.), and four men were used for putting down the last 12 ft. of hole, so that it required 70 hr. of labor at 15 ct. per hr., or \$10.50, for a 30-ft. hole, making the cost 35 ct. per ft. In brown sandstone it required 70 to 80 hr. labor to put down 30 ft. The drill holes were 2 3/4 in. at top and 1 1/2 in. at bottom. Drilling with steam drills in this same stone, holes 20 ft. deep, cost 12 ct. per ft., including everything except interest, depreciation and drill sharpening. The cost of hand drilling agrees very closely with my own records of similar work in Pennsylvania.

Trautwine gives the following rates of drilling 3-ft. vertical holes, starting with a 1 1/4-in. bit, one man drilling with a churn-drill, shift 10 hr. long:

Solid quartz	4 ft. in 10 hr.
Tough hornblende	6 " " "
Granite or gneiss	7.5 " " "
Limestone	8.5 " " "
Sandstone	9.5 " " "

It should be observed that the holes in this case are shallow

(3 ft.), and the diameter ($1\frac{3}{4}$ in.) is large for such shallow holes, indicating that Trautwine's data applied to rock excavation where black powder was used.

In drilling blast holes in the stripping of iron ore on the Mesabi Range, Minn., in many cases the holes are drilled by men with long churn-drills. The stripping is done and the ore is excavated by steam shovels. The stripping is done as a rule in lifts of from 20 to 30 ft., until near the ore, when the "clean up cut" is made from 6 to 10 ft. In the ore, cuts are made from 10 to 25 ft. deep, depending on the grade of tracks, and the particular part of the ore body being excavated. The holes for blasting are bored to the depth of the steam shovel cutting on a 20-ft. lift. High lifts are not worked much on account of the banks caving in on the shovel. The holes are placed about 20 ft. apart, staggered along the bench, two abreast. The drills are of 1-in. to $1\frac{1}{4}$ -in. octagonal steel, with $1\frac{1}{2}$ -in. bits, and are operated by from 2 to 4 men, according to depths reached. The drills are lifted by means of a movable steel cross piece or arm, one for each pair of men. The cross piece is held to the drill by wedges. In the stripping, one man averages 10 ft. of hole in 10 hr. In ore, 24 ft. per man are drilled per day. With 4 men in a gang, and with wages at \$2 per day, the cost of drilling for labor for 40 lin. ft. of hole is \$8, or 20 ct. per lin. ft. This gives a cost of about $1\frac{1}{8}$ ct. per cu. yd. In a 24-ft. bench of ore, the cost of drilling per linear foot of hole is 8 ct. This makes a cost of $\frac{7}{8}$ ct. per cu. yd.

The Use of Augers for Boring Blast Holes in Hard Clay and Soft Rock. Although earth augers were among the earliest devices for sinking holes in material that was to be blasted, it is a curious fact that churn or percussion drills are frequently used where augers would be preferable. A cable drill is often far less effective in clay and soft rock than an auger for drilling wells. In California the best well drilling outfits are now equipped with augers as well as with churn drills.

In a recent description of work on the Kachess Dam, Wash., Mr. E. H. Baldwin tells of the unsuccessful use of a 3-in. well drill (of the cable type) for drilling blast holes in hard clay. The clay had to be blasted so that it could be excavated with orange peel buckets. It was found practicable to put down the holes with an earth auger, after driving a 3-in. casing ahead. The auger was attached to $\frac{3}{4}$ -in. pipe and turned by hand with Stillson wrenches, which were also used to lift the auger to clean it. Holes were bored about 20 ft. deep and 20 ft. apart, and each hole loaded with a box of 20% stumping powder. The cost of drilling and shooting this clay was 4 ct. per cu. yd.

Both in mining and railway tunnel work, augers have often

been used to advantage, particularly in fire clay, shale and soft sandstone. In mining coal the greatest development of boring machines for this purpose has occurred. Therefore anyone having to do blast hole boring in hard clay or soft stone, should familiarize himself with boring machines used in coal mining.

Trimming the Side of a Rock Excavation. In open cut work where rock is encountered the rock sides of the cut seldom have to be dressed up with any nicety, but in foundation work it is often necessary to do so and also in canal construction. Where large areas of the sides of cuts are to be smooth and even, channeling machines are used, but on small jobs the work is generally done by hand. In New York city this character of hand work is often done on cellar excavation, to admit of machinery being installed and structural steel and brick walls being erected.

The following example was on such a piece of work in New York, the work being mica schist. After the excavation was made, one side for a distance of 64 ft. had to be dressed up. From about 2 in. to 5 in. of the rock face had to be clipped off. The work was done by men working two together, one holding a heavy bull point, by an iron handle, and the other using a striking hammer. For 4 days 4 men were engaged on the job, and for 3 days 6 men were at work. With wages \$1.50 per day of 10 hr., this gave a cost of \$51. Ordinary laborers were used to do the work. For 32 ft. the rock cutting was 8 ft. high and for the other 32 ft. it was only 6 ft. high, making in all 448 sq. ft. This gave a cost of 11.4 ct. per sq. ft. of rock face trimmed. Two men working together did on an average of 26.5 sq. ft. per day. These costs do not include any allowance for dressing the bull points.

CHAPTER III

DRILL BITS: SHAPE, SHARPENING AND TEMPERING

Hand Drill Bits. A bit performs least work at its center (contrary to Drinker's statements), and this is well shown by the fact that a bit wears most rapidly on its projecting ears. The rock near the center of the hole is struck more blows per sq. in. per min. than anywhere else; hence it is quickly cut away; whereas the rock near the circumference of the hole is not struck so often per unit of area and is more slowly cut or crushed to pieces. The ears of the bit may project considerably beyond the stock of the drill rod when the rock is soft, because they wear less rapidly and resist breaking off better than in tough, hard rock. The width of the bit may be 30% to 100% greater than the diameter of the drill rod, depending upon the hardness of the rock.

For one-hand hammer drilling an octagon steel rod $\frac{3}{4}$ to $\frac{5}{8}$ in. in diameter is commonly used; but $\frac{5}{8}$ -in. to 1-in. steel may be said to be the limits of size used for one-hand drilling. In comparatively soft rock a $\frac{5}{8}$ -in. octagon bar may have a 1-in. bit, a $\frac{7}{8}$ -in. bar, a $1\frac{1}{4}$ -in. bit; and a $1\frac{5}{8}$ -in. bar, a 3-in. bit, the larger sizes of bits being used only in two-hand hammer drilling or churn drilling. In two-hand hammer drilling a $1\frac{1}{4}$ to $1\frac{1}{2}$ -in. hole for a starter in medium hard rock that is to be drilled to depths of 6 or 8 ft. is common; for it must be remembered that as the hole grows deeper it grows smaller in diameter, due to the continuous wear on the ears of the bits, so that unless a reamer were used it would be impossible to have a uniform diameter of hole except in very soft rock.

The least admissible diameter of hole at the bottom is about $\frac{3}{4}$ in., where dynamite is used. In the days of black powder a much larger hole was necessary in order to hold enough explosive, although it cost more money to drill the hole; thus in the Hoosac Tunnel the holes were only 2 ft. deep and $1\frac{3}{8}$ in. in diameter at the mouth of the hole. It is a hard rock that will wear the ears of the bit so fast as to reduce the diameter of the hole $\frac{1}{8}$ in. in drilling 2 ft., so that a hole 6 ft. deep need not have a diameter at the mouth more than $\frac{3}{4}$ in. greater than at the bottom even in very hard rock.

The chisel edge of a bit is ordinarily made not straight across,

but slightly curved. Different authorities have assigned different reasons for giving this curvature to a bit. Drinker says that in hard rock the curve must be quite flat, but in soft rock it must be very rounding; and his reason is that the wear of the bit being greatest at the center permits of a more rounding form for soft rock. As a matter of fact the wear is never greatest at the center of a bit, and in any case his inference is illogical. Aitken says that the bit is made rounding so as to give greater strength to the ears, and following this reason to its logical conclusion would give us a very rounding bit for very hard rock — precisely the opposite of the form recommended by Drinker. To me it seems apparent that a rounded cutting edge is especially desirable in starting a hand-drilled hole, for it insures effectiveness of the first few blows by concentrating the work upon a small area. Moreover, for the first few inches of the hole, a rounded cutting edge is desirable because any slight tilting of the drill will not mean the concentration of the energy of the blow upon one of the ears, which is the weakest part of the drill and most easily broken. In machine drilling this is not important, but in hand drilling it certainly cannot be overlooked. As corroborating this theory it should be noted that the short drills used for drilling plug and feather holes in granite are invariably made very rounding or convex; whereas in drilling deep holes in sandstone consisting of coarse grains poorly cemented together, a perfectly straight-edged drill is common. A rounded or convex bit cuts a cup-like bottom in the drill hole, which aids in keeping the drill centered; and it is not improbable that the cup acts like a mortar in which the chips from the edges of the hole collect at the center and are more quickly pulverized. The collecting of chips at the center of this stone mortar gives the bit more work to do at its center, which is precisely what should be done in view of the fact that the outer edges would otherwise have most of the work to do.

The wedge-shaped edge of a bit is made as sharp as will hold up without rapid dulling or chipping. In hard rock the bit is made thick near the edge, and with angle of nearly 90°. In soft rock the bit is thin and sharp, with an angle of about 45° between the faces. To this rule there is an exception, for where the rock is a sandstone of rather coarse grains poorly cemented together, a bit that has a blunt edge works fastest. This is due to the fact that the grains of poorly cemented stone are easily broken apart and then the blunt edge crushes them quickly like a pestle in a mortar. A blunt bit is used in drilling small holes in earth, but for a different reason; the blunt *bit in earth compacts* the earth and crowds it aside, necessitating *less cleaning out of the hole.*

Machine Drill Bits. We have thus far considered only the plain chisel bit, which is the type commonly used in hand drilling. For machine work it is essential that the cutting edge of the bit be neither too sharp nor too blunt, for if too sharp it will drive deep into the rock and bind; if too blunt it will not fracture the rock properly but its force will be spent in crushing. The wings or corners of the bit should not be too heavy but as thin as is consistent with the requirements for strength in order to permit the cuttings or sludge to escape freely. The diameter of the cutting edge must be the greatest diameter of the bit in order to permit of free action in the hole. The wings must be of equal length or the hole will be driven rifled and irregular or the drill will break.

Figs. 4,—A to O, from an article by T. H. Proske, in *Mining and Scientific Press*, March 5, 1910, and reprinted in *Engineering and Contracting*, March 23, 1910, show the shapes of drill bits in use.

Fig. 4A represents the square cross-bit adopted as the standard for American mining practice. It is made from either round, octagon, or cruciform steel. In the copper mines of Michigan, it is usually made of a round steel. In the iron mines of Michigan and Minnesota and wherever this form of bit is used east of the Rocky Mountains, octagon steel is preferred, but in the Rocky Mountains and Pacific States cruciform steel is used. The reason for the adoption of this form of bit as a standard will be appreciated when the three requirements of a rock-drill bit are recalled. These are, "to chisel out a hole in the rock," "to keep this hole round and free from rifles," and "to mud freely." There is really a fourth requirement, which is "to do as much drilling as possible before being resharpened."

The different kinds of rock to be drilled affect the wear of the bit. Very hard rock will blunt the chisel and reaming edges. The softer rocks do not blunt these edges, but wear the outer sides so that it loses its gage and size, still appearing to be quite sharp. For this reason a bit that is made with a square edge and a clearance angle of 8 degrees will drill about four times as long in soft rock as a bit with round edges and a clearance angle of 16 degrees, before being reduced to the size of the next bit that is to follow. Referring to Figs. 4A and B, the latter being a round-edge bit with a clearance angle of 16 degrees, it will be seen that in Fig. 4A the corners of the bit at the base of the bevel describe a circle that is equal to the circle that the chisel edges describe. This is as it should be, as it is impossible for the chisel edge to cut out all of the rock. The reaming edge, which is that part of the bit extending from the chisel edge to the base of the bevel, marked "a" in both Fig.

4A and Fig. 4B, must ream the outer edge of the hole and keep it round and free from rifles. In Fig. 4B it will be noted that the circle described by the corners of the bit at the base of the bevel is much smaller than the circle described by the chisel edges. This causes an excess of wear on the corners of the chisel edges, the bit rapidly loses its gage, as well as its efficiency, and it is almost impossible to keep the hole round. Rifles form, and these cause the rotation parts of the drilling machine to break, often resulting in the loss of the hole.

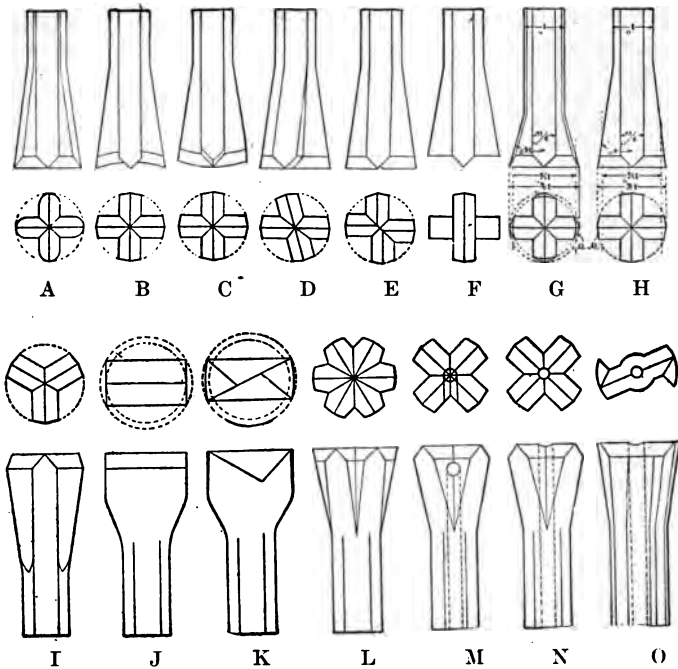

Fig. 4. Types of Machine Drill Bits.

The angle of the bevel of the face of the bit has to do with its life as well as with the property of "mudding" freely. It is generally accepted that if this angle be 90 degrees it gives strength and permits the bit to "mud" or throw back the cuttings from the face of the bit when the drill is pointed downward. Bits made like Fig. 12D and Fig. 12E will not "mud" freely. Another reason why bits such as is shown in Fig. 4A

are preferable to those illustrated by Fig. 4B, is that having a long wing they are stronger and will not break so readily as does a short bit.

The Simmons bit, used at the Champion mine at Beacon, Mich., is shown in Fig. 4C. Two of the wings are devoted entirely to reaming and keeping the hole round and free from rifles. Some tests made several years ago in jasper, the hardest rock found in the Champion mine, using a 2¼-in. Rand drill with 60-lb. air pressure at the compressor, showed an average speed per minute of 0.28 in. for the ordinary cross-bit, and 0.66 in. for the Simmons bit. Both forms were hand-sharpened.

The Brunton bit, the invention of D. W. Brunton, is extensively used in Idaho and Montana. It is shown in Fig. 4D. The object of this bit is to obtain the advantages of the X-bit without the attendant difficulties of re-sharpening. With this bit, as in the case of the X-bit, the piston must revolve a half turn before the cutting edges will strike in the same place a second time. It is as easily re-sharpened as the regular square cross-bit.

The X-bit is shown in Fig. 4E. Since the invention of power-drill sharpening machines, this bit is fast disappearing. The reason will be understood when a comparison is made with the regular square cross-bit, as made with the power-sharpener, and the cross-bits as they are re-sharpened by hand, shown in Fig. 12C, Fig. 12D, and Fig. 12E. The X-bit is designed to prevent rifles. This the hand-sharpened cross-bit would not do, but the machine-sharpened cross-bit effectually accomplishes.

Fig. 4F shows what is commonly termed the high-centre bit. This was for many years accepted as the proper form. It is still used in the mines of Cornwall and where Cornish customs prevail. Since the introduction of hammer-drills this bit is again finding favor. It is of especial advantage in starting a hole, the high centre immediately making an impression on the rock, whereas the square-faced bit requires a flat face for ready starting. For a starting bit in hammer machines it has no equal. Here, however, its advantages over the square bit end. Used as a bit to follow the starter, it is liable to follow slips and seams in the rock, causing crooked holes, which are sometimes lost before being finished. This the square bit will not do.

Fig. 4G shows a bit having the corners in advance of the centre. This is a fast cutting bit. The corners break up the rock in advance of the centre and leave little for the centre to do; this causes the corners to wear fast, but still not to excess when it is considered that they do most of the work. This drill will not follow slips and seams, will drill a round hole, and is easy on the drilling machine. The weak point of this form is that the

leverage is so great on the corners that they are apt to break off if tempered too hard.

Fig. 4H shows the round-edge bit, which is a favorite with some. In soft rock this is good, but in hard rock it permits rilles to form in the hole because there are no reaming edges.

The Y-bit, Fig. 4I, gives plenty of room for the cuttings to escape. It is, however, quite difficult to make and re-sharpen by hand. With the power-sharpener it can be made as easily as any other form.

Fig. 4J shows the "bull" bit in use in the lead and zinc mines of the Joplin, Missouri, district, before the introduction of the power-sharpener. The extreme hardness of the limestone and flint in the sheet-ground of that district, caused the ordinary cross-bit as made by hand to wear too fast. This dull bull-bit therefore had to be adopted. Drilling here was not a matter of cutting the rock, but of shattering it by impact. The power-sharpener has changed all this, and the American standard cross-bit as made in these machines is now used. As a result the capacity of the drills has been materially increased. In mines where hand-sharpening is still done the bull-bit is yet in use.

Fig. 4K shows the Z-bit used in hand-sharpening in the south-east Missouri lead district. This bit is also used quite extensively in Germany. In both places, however, the advantage of the standard square-cross-bit as made with the power-sharpener is fast causing it to be displaced.

Fig. 4L shows the "six-wing rosette" bit as made in the power-sharpener in use at the Penarroya mines in Spain. It is used in hammer drills only. Of all the rosette forms of bit this has been found to be the most satisfactory.

Fig. 4M shows the square cross-bits when made up for hammer drills where a hole for the introduction of air or water to remove the cuttings apexes at a point back from the level of the bit in one of the recesses between the wings.

Fig. 4N shows the same form where the hole ends in the centre of the cross of the cutting edges. This form of bit is extensively used. Its faults are that a core is formed by this hole; this core fills the hole, and causes a stoppage of air or water. These cores have been known to become as much as 8 in. long, and are quite difficult to remove. To clear them away the core must be burned out by heating the steel the full length of the core in a slow fire; a sometimes slow and tedious process. This difficulty is entirely overcome by the use of the bit shown in Fig. 4M.

The Z-bit, Fig. 4O is extensively used in Germany. In hammer drilling machines, the steel is formed in bars having a Z

shape. While this bar is shown straight, it is usually twisted to form a spiral. It is an easy matter to form a Z-bit on the end of such a bar. The results obtained are excellent. Holes to a depth of 16 ft. horizontal have been drilled with this form of steel. The spiral draws out the cuttings much the same as an auger.

The flat or "bull" bit, is made in various shapes, but no matter how it is made its use is very severe on a rock drill machine. If thin, it has no reaming qualities; if made heavy as it generally is, the blow delivered imparts a severe jar to the machine. The flat bit with diamond point has been used in marble quarries from the earliest introduction of the machine drill. The steam pressures in use then were considerably lower than now, so this bit cut slow enough to ream the holes fairly well. Upon the introduction of high pressures, its cutting capacity was increased while its reaming qualities remained the same. In theory, the bull bit should be the fastest cutting bit especially in soft rocks, but it actually breaks off large pieces and buries itself, resulting in "sticking."

Types of Drill Bits Adopted in South Africa. Fig. 5 shows the shapes and dimensions of various drill bits recently adopted at the Robinson Mines, South Africa. The tests, according to the *Engineering and Mining Journal*, were made to determine the most suitable steel for use in the Rand mines. Many varieties of steel have been tested in the following way.

From 40 to 60 drills made from each brand of steel were sharpened by hand, weighed, measured by a micrometer gage, then sent to the mine, where they were used in $2\frac{3}{4}$ -in. machines to drill the hardest rock. The depth of holes drilled and time taken were noted. The drills were then sent to the surface, where they were again weighed and measured and the quality of the steel compared by the loss in gage.

It was difficult to convince the Rand miners that the proper heating and tempering of the steel has an important bearing on the efficiency of the drills, so it was necessary to recommend steel of such carbon content as would permit of direct plunging in the type of tank that gives a limited depth of immersion for cross bits.

The bits, as finally adopted, are shown in Fig. 5. They are used in $2\frac{1}{2}$ and $2\frac{3}{4}$ -in. machines. The starting bit is used to drill 15 in. of hole, the second 21 in. and the third and fourth 24 in. each.

With higher air pressure it is believed that the third and fourth bits should be made of 1 in. steel, as even with 70 lb. air pressure a $2\frac{3}{4}$ -in. machine will bend some of the $\frac{3}{4}$ -in. drills. From 0.7 to 0.75% carbon is the highest that will permit of steel

being satisfactorily welded and which will temper without cracking on direct plunging.

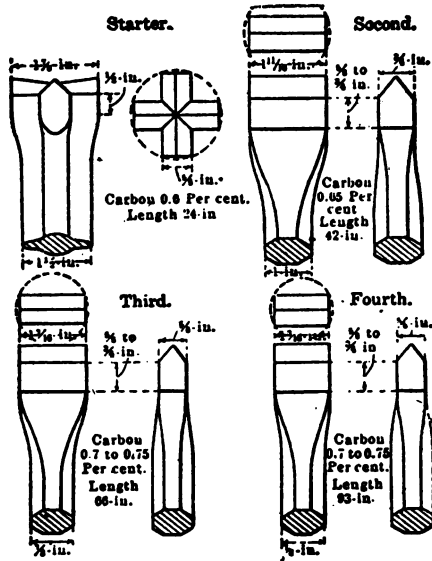

Fig. 5. Types of Drill Bits, South African Mines.

Bits for Removing Cuttings. A hollow drill bit with side channel for ejecting sludge. An Australian by the name of Tippet devised a drill with a hollow chamber running longitudinally through the center of the shank, where it meets a curved outlet to the side just below the chuck, through which the sludge is ejected. The sludge enters the hollow steel on the down stroke, the inertia of which is not entirely overcome during the period of the return stroke. The steel used with piston drills is $1\frac{1}{4}$ in. in diameter, through which passes a $\frac{3}{4}$ -in. channel. The central channel becomes filled with sludge but does not choke with pieces of rock (granite) even when as large as a 10-cent piece. It has been found, according to Mr. Geo. Weston, in *Engineering and Mining Journal*, that with this bit the steel loses its gage less rapidly. A total of 37 in. of hole was drilled by a New Century air-hammer drill in 12 min., operating at 55 lb. pressure, as follows: with $1\frac{1}{8}$ -in. steel, $15\frac{1}{4}$ -in. of hole; with $1\frac{3}{8}$ -in. steel, $16\frac{3}{4}$ in.; with $1\frac{1}{2}$ -in. steel, 5 in.

Drill Bit with Lugs. Fig. 6 illustrates a drill steel manufactured by the Wood Drill Works, which has lugs on the sides for removing the cuttings. These lugs act as scrapers and bring out small portions of dirt on each back stroke.



Fig. 6. Lug Drill Steel.

Removal of Sludge. The reader is referred to steels used with the auto traction drill (page 143), to the articles on the water and air jets in the following chapter, and to the descriptions of the use of hollow steels, for further information in the matter of removing drill cuttings.

The Derby Tubular Drill Bit. Lieut. Geo. McC. Derby (now Major of Engineers, U. S. A.) invented a drill bit that was used in drilling on the Flood Rock work, and it proved so greatly superior to the other bits that I regard it as worthy of special description. Maj. Derby wrote me that he patented the drill bit in 1885 and sold the patent rights to the Rand Drill Co., which never placed it upon the market. The drill steel was hollow, as was also the bit which was provided with six points or teeth. The bits were sharpened very much like the bits used in the pneumatic hammer drills. Each bit was only 2 to 6 in. long and fastened to the end of the hollow wrought iron drill rod with a steel pin or expanding copper ring. This saved steel and saved transporting long, heavy drill rods to and from the blacksmith shop. This bit was used with the ordinary percussive air drill, and, in drilling, a small core was formed which broke up under a slight blow on the drill rod. The chips were washed out of the hole by a current of water that was forced down through the hollow drill rod. The water was introduced into the hollow drill rod, either through the rotating bar or through a sleeve surrounding the piston rod which was lengthened for this purpose; the first method being the best. Maj. Derby informs me that the coarse chips of gneiss rock broken off by the bit are washed out whole, instead of being reduced to dust, which saves power and time in drilling a hole of given depth. This fact is well shown by the following comparative records: Experiments were conducted for several months of actual work, during which time 39,119 ft. of hole were drilled with X-bits and 39,200 ft. with the Derby tubular bit. The holes were about 9 ft. deep, and Rand "Little Giant" drills were used. As a result of this competition it was found that the tubular bit drilled $51\frac{1}{2}\%$ faster than the X-bit, and that the diameter of the bottom of the hole was 25% greater than with the X-bit.

which in itself is a decided advantage. Using a starter X-bit of $3\frac{1}{4}$ in., the bottom of a 10-ft. hole was 2 in. diam.; but with the tubular bit the bottom was $2\frac{1}{2}$ in. diam. Moreover the tubular bit made a perfectly round hole, which lessens the chances of a bit's sticking. It seems to me that the greater speed of drilling with the tubular bit was due to the use of a jet of water to wash out the chips, which also accounts for the fact that the bit does not wear so rapidly. Whatever the reason, the record of excellence of the tubular bit is well worthy of serious consideration by all who are interested in economic drilling.

Air Hammer Drill Bits. The following is from a paper by G. E. Walcott in *Mining and Scientific Press*, reprinted in *Engineering and Contracting*, January 11, 1911.

Fig. 7 shows the construction of a bit which has been made to overcome the objection of difficult turning and which has been widely adopted for air-hammer machines. The dimensions given are such as would ordinarily be used for a starter bit where $1\frac{1}{8}$ -in. ribbed steel is used. The object of the high center is briefly this. When starting a hole with a square bit it is always found that there is a tendency, more or less pronounced, according to the nature of the rock and the shape of the face, for the bit to rotate about one corner of the steel rather than about the center. The result is either a broken corner or difficulty in getting the hole started, or both. With the high center, the latter strikes the rock first and rotation about the center is easily effected. The result is that no difficulty or loss of time is experienced in starting a hole. Another advantage is that the drill stays sharp longer than with a square bit. The tendency in any bit is for the outer corners, which have the most cutting to do, to wear away or become blunt first. With the high center the cutting is more equally distributed.

The angle between the faces of cutting edge has been shown as 90 degrees. The exact angle is not material, but it is of the utmost importance that it should not be acute. It is natural to imagine that a sharp bit means fast cutting, but the reverse of this is frequently the case. In Fig. 8 is illustrated the reason for this. In *a* has been represented by the wedge *A* the conditions which exist on a bit with a 90 degree angle, and in *b*, conditions with a bit having an acute angle. Suppose these wedges to be drawn along the smooth surface *ss* and to meet the obstruction *o*. The difficulty in passing over the obstruction will be proportional to the angle α . The result is that with a sharp bit either the obstruction must be broken off by the force exerted in turning the drill, or the point of the bit will be broken.

In this case the operator, rather than the machine, does the work of breaking the rock. With a slight interruption in the turning, the difficulty at once increases as the hammer is continually striking and the relative height of the obstruction constantly increases until it is impossible to turn the bit. Another reason for the blunt edge is that a hard temper may be given it

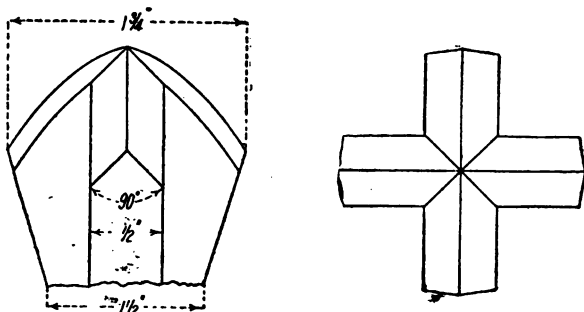

Fig. 7. "High Center" Bit.

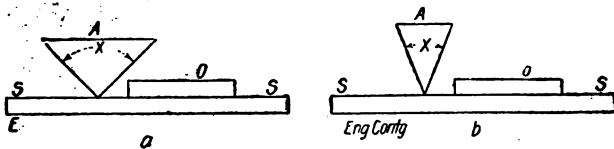

Fig. 8. Weakness of Sharp Bits in Turning.

without danger of breakage, and in drilling hard ground this is a prime requisite.

Often the importance of having proper steel with proper bits is not fully realized and too little attention is given to this point. The result is that in many cases hundreds of dollars are lost every month in wages paid to men who are doing nothing but waiting for steel or trying to perform work with such tools as render it impossible to accomplish good results.

Shapes of Pneumatic Hammer Bits. Table IV. shows the types of hammer drill bits and their relative drilling speed given in the catalog of the Sullivan Machinery Company.

Fig. 9 shows the steels used with the Ingersoll-Rand "Jack-hammer" and the Sullivan "Rotator." Hollow hexagon steel with a six-point rose bit is recommended for hard and medium hard rocks where air is used to eject the cutting. Solid twisted spiral

steel with a four-point bit or a Z-bit is best suited to drilling in hard ground where dust raised by hollow bits is objectionable. Hollow spiral steel with a four-point, Z, single or double chisel-bit is used in soft or medium hard and wet ground where difficulty in clearing the cuttings is experienced. Solid twisted steel with a fish-tail or Y-bit is intended to use in soft rock commonly known as "auger" ground.

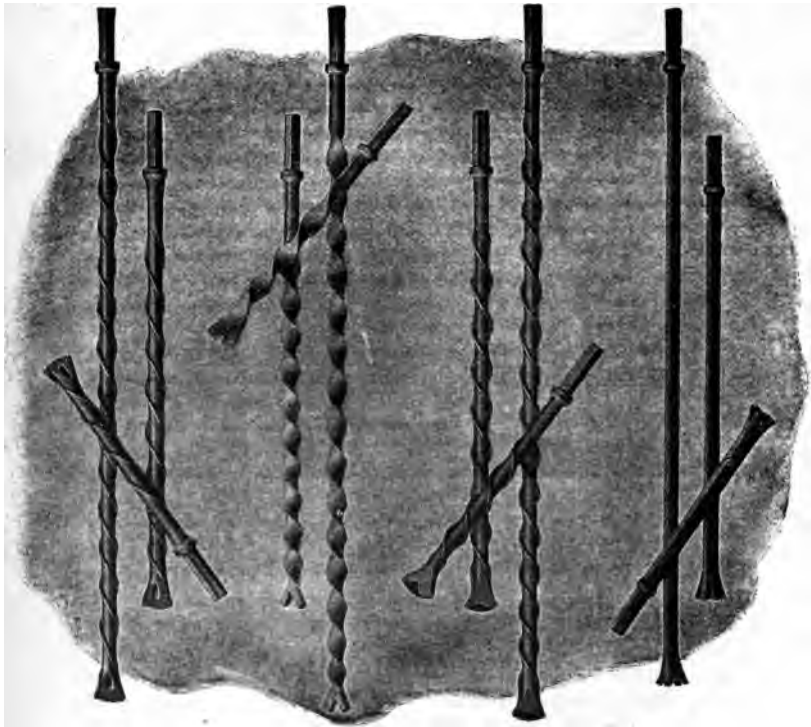

Fig. 9. Steels Used With "Jackhammer" and "Rotator."

DRILL BITS: SHAPE, SHARPENING AND TEMPERING 49

TABLE IV. SHAPES OF AIR HAMMER DRILL BITS AND RELATIVE DRILLING SPEEDS

(Sullivan Machinery Co.)

Description of Bit	Duration of Runs, Min.	Diameter of Hole Drilled, In.	Average Depth Drilled per Run 70 lb. per In.	Average Depth Drilled per Run 85 lb. per In.	Remarks
25 Degree Diamond Point +	2	1%	6%	8½	Spots easily. Hole rifles slightly. Rotation easy. Gauge does not wear rapidly.
25 Degree Diamond Point X	2	1%	6	7¾	Spots easily. Drills round hole. Rotation easy. Gauge fairly durable.
Convex +	2	1%	6%	8¼	Spots easily. Hole rifles slightly. Rotation easy. Gauge does not wear rapidly.
Flat +	2	1%	6	7½	Difficult to spot hole. Hole rifles badly. Rotation hard. Gauge fairly durable.
4 Degree Concave +	2	1%	5%	8¼	Difficult to spot hole. Hole rifles badly. Rotation hard. Gauge fairly durable.
25 Degree Pointed Bull —	2	1%	5%	7	Spots easily. Drills round hole. Rotation easy. Gauge wears rapidly.
Flat Bull —	2	1%	5½/16	7¼	Difficult to spot hole. Hole rifles badly (3 flutes). Rotation hard. Gauge wears rapidly.

Size of Percussive Drill Bits. As is explained later, each longer set of drills must have a slightly smaller bit, for all drill holes grow narrower with depth. The exact reduction in size depends upon the hardness of the rock, and is ascertained by experiment. In rocks where the drilling speed is very high the bits do not wear rapidly and the difference in the diameters of the successive bits does not need to be as great as in hard rocks. This decrease in diameters of successive bits is usually ¼ in. On the Livingstone Improvement of the Detroit River two types of bits were used, one for very hard rock and the other for the softer grades.

	Depth Drilled, Ft.	Diam of steel, In.	Diam of bit for soft rock, In.	Diam. of bit for hard rock, In.
Starter,	2	1¾	3¾	2½
	4	1¾	3¾	2¾
	6	1¾	3¾	2¼
	8	1¾	3½	2½
	10	1¼	3¾	2
	12	1¼	3¼	1¾
	14	1¼	3	1¾
	18	1¼	3	1¾

For a percussive drill having 3 to 3¼ in. cylinder and a 2 ft. feed, the following is typical:

	Depth of Drilled, Ft.	Diameter of Steel, In.	Diameter of Bit, In.	Weight, Lb.
Starter,	2	1¼	2½	11
	4	1¼	2¾	19
	6	1½	2¼	23
	8	1½	2½	31
	10	1½	2	39
	12	1½	1¾	47
	14	1½	1¾	55
	16	1½	1¾	63
	18	1½	1½	71
	20	1½	1¾	79
Total weight of the set.....				438

TABLE V. WEIGHT OF DRILL STEELS FOR PERCUSSIVE DRILLS.

Diameter of drill cylinder, In.	Feed In.	Diam. of steels, start and finish, In.	Diam. of bits, start and finish, In.	Depth of drill hole, Ft.	Weight of a set of drill steels, Lb.
2	12	¾ - ¾	1½ - 1	5	31
2¼	15	1 - ¾	1¾ - 1¼	6¼	53
2½	20	1 - ¾	1¾ - 1¼	8½	69
2¾	24	1½ - 1	2½ - 1½	12	148
3 to 3¼	24	1½ - 1½	2½ - 1¾	20	438
3½	24	1¾ - 1¼	3 - 1¾	20	532
3¾	30	1¾ - 1¼	3 - 1¾	27½	779
4¼	30	1¾ - 1½	3¾ - 2	35	1,860
5	30	1¾ - 1½	4 - 2	39½	2,257

Note: The first two steels (the "starter" and its successor) are of the larger diameters given in the third column; and the steels succeeding them are of the smaller diameters.

Sharpening Hand Drill Bits. A good blacksmith is as essential to economic rock excavation as good hand drillers. For this reason every contractor and every mine manager having charge of drilling operations should know at sight a good blacksmith when he sees him do his work. To be able to do this it is not necessary to become a blacksmith, but simply to learn the art of drill sharpening by reading and by watching and by inquiry. One of the best foremen of rock excavation that I know is a cripple who has never done a stroke of drilling or tool sharpening himself; but he knows exactly how it should be done and cannot be imposed upon by a pretender. The educated man is apt to be fearful of showing himself ignorant of practical work by inquiring into the methods of the drill sharpener.

To begin with the blacksmith must have good drill steel (not tool steel) to work with. Drill steel contains 0.7% to 1% of carbon. If the steel loses any of this carbon by oxidation it becomes softer and dulls quickly. In heating the bit it is therefore essential: (1) That the heating be not too long continued, nor carried above a cherry red; (2) that the air blast be not too

DRILL BITS: SHAPE, SHARPENING AND TEMPERING 51

TABLE VI. WEIGHTS IN LB. PER FT. OF SOLID AND HOLLOW DRILL STEEL

Size in.	Round		Square		Hexagon		Octagon		Cruciform		Quarter Oct'n.	
	Solid lb.	Hollow lb.	Solid lb.	Hollow lb.	Solid lb.	Hollow lb.	Solid lb.	Hollow lb.	Solid lb.	Hollow lb.	Solid lb.	Hollow lb.
3/16	0.09	0.12	0.12	0.12	0.12	0.12
1/4	0.17	0.21	0.19	0.18	0.18	0.18
5/16	0.26	0.33	0.29	0.28	0.28	0.28
3/8	0.38	0.48	0.43	0.40	0.40	0.40
7/16	0.51	0.65	0.56	0.54	0.54	0.54
1/2	0.67	0.85	0.73	0.70	0.70	0.70
9/16	0.85	1.08	0.93	0.89	0.89	0.89
5/8	1.04	1.33	1.15	1.08	1.08	1.08
3/4	1.26	1.61	1.44	1.32	1.32	1.32
7/8	1.48	1.91	1.74	1.56	1.56	1.56
1 1/8	1.77	2.25	2.08	1.83	1.83	1.83
1 1/4	2.03	2.60	2.43	2.12	2.12	2.12
1 3/8	2.34	2.99	2.82	2.44	2.44	2.44
1 1/2	2.65	3.40	3.23	2.77	2.77	2.77
1 5/8	3.00	3.84	3.67	3.14	3.14	3.14
1 3/4	3.38	4.20	4.13	3.54	3.54	3.54
1 7/8	3.75	4.63	4.56	3.93	3.93	3.93
2	4.15	5.31	5.14	4.42	4.42	4.42
2 1/8	4.57	5.86	5.69	4.91	4.91	4.91
2 1/4	5.01	6.43	6.26	5.35	5.35	5.35
2 3/8	5.52	7.03	6.86	5.89	5.89	5.89
2 1/2	6.00	7.65	7.48	6.45	6.45	6.45
2 5/8	6.52	8.31	8.14	7.06	7.06	7.06
2 3/4	7.05	8.98	8.81	7.59	7.59	7.59
2 7/8	7.60	9.70	9.53	8.23	8.23	8.23
3	8.18	10.41	10.24	8.83	8.83	8.83
3 1/8	8.81	11.17	11.00	9.50	9.50	9.50
3 1/4	9.38	11.95	11.78	10.15	10.15	10.15
3 3/8	10.01	12.76	12.59	10.85	10.85	10.85
3 1/2	10.71	13.60	13.43	11.58	11.58	11.58
3 3/4	12.05	15.40	15.23	13.43	13.43	13.43
3 5/8	13.60	17.20	17.03	15.23	15.23	15.23
3 3/4	15.10	19.20	19.03	17.03	17.03	17.03
3 7/8	16.68	21.20	21.03	18.83	18.83	18.83
3 5/4	18.30	23.50	23.33	20.63	20.63	20.63
3 3/2	20.18	25.70	25.53	22.43	22.43	22.43
3 5/8	22.06	28.20	28.03	24.23	24.23	24.23
3 3/4	24.10	30.60	30.43	26.03	26.03	26.03

Note: The size of the hole in hollow steel is assumed for purposes of calculation at 3/4 in. Actually it varies with size of drill and specification.

For a percussive drill having 3 to 3¼ in. cylinder and a 2 ft. feed, the following is typical:

	Depth of Drilled, Ft.	Diameter of Steel, In.	Diameter of Bit, In.	Weight, Lb.
Starter,	2	1¼	2½	11
	4	1¼	2¾	19
	6	1½	2¼	23
	8	1½	2½	31
	10	1½	2	39
	12	1½	1¾	47
	14	1½	1¾	55
	16	1½	1¾	63
	18	1½	1½	71
	20	1½	1¾	79
Total weight of the set.....				438

TABLE V. WEIGHT OF DRILL STEELS FOR PERCUSSIVE DRILLS.

Diameter of drill cylinder, In.	Feed In.	Diam. of steels, start and finish, In.	Diam. of bits, start and finish, In.	Depth of drill hole, Ft.	Weight of a set of drill steels, Lb.
2	12	¾ - ¾	1½ - 1	5	31
2¼	15	1 - ¾	1¾ - 1¼	6¼	53
2½	20	1 - ¾	1¾ - 1¼	8½	69
2¾	24	1½ - 1	2½ - 1½	12	148
3 to 3¼	24	1½ - 1½	2½ - 1¾	20	438
3½	24	1¾ - 1¼	3 - 1½	20	532
3¾	30	1¾ - 1¼	3 - 1¾	27½	779
4¼	30	1¾ - 1½	3¾ - 2	35	1,860
5	30	1¾ - 1½	4 - 2	39½	2,257

Note: The first two steels (the "starter" and its successor) are of the larger diameters given in the third column; and the steels succeeding them are of the smaller diameters.

Sharpening Hand Drill Bits. A good blacksmith is as essential to economic rock excavation as good hand drillers. For this reason every contractor and every mine manager having charge of drilling operations should know at sight a good blacksmith when he sees him do his work. To be able to do this it is not necessary to become a blacksmith, but simply to learn the art of drill sharpening by reading and by watching and by inquiry. One of the best foremen of rock excavation that I know is a cripple who has never done a stroke of drilling or tool sharpening himself; but he knows exactly how it should be done and cannot be imposed upon by a pretender. The educated man is apt to be fearful of showing himself ignorant of practical work by inquiring into the methods of the drill sharpener.

To begin with the blacksmith must have good drill steel (not tool steel) to work with. Drill steel contains 0.7% to 1% of carbon. If the steel loses any of this carbon by oxidation it becomes softer and dulls quickly. In heating the bit it is therefore essential: (1) That the heating be not too long continued, nor carried above a cherry red; (2) that the air blast be not too

DRILL BITS: SHAPE, SHARPENING AND TEMPERING 51

TABLE VI. WEIGHTS IN LB. PER FT. OF SOLID AND HOLLOW DRILL STEEL

Size in.	Round		Square		Hexagon		Octagon		Cruciform		Quarter Oct'n.	
	Solid lb.	Hollow lb.	Solid lb.	Hollow lb.	Solid lb.	Hollow lb.	Solid lb.	Hollow lb.	Solid lb.	Hollow lb.	Solid lb.	Hollow lb.
3/16	0.09	0.12	0.10
1/4	0.17	0.21	0.19	0.18
5/16	0.26	0.33	0.29	0.28
3/8	0.38	0.48	0.43	0.40
7/16	0.51	0.65	0.56	0.54
1/2	0.67	0.85	0.73	0.70
5/8	0.85	1.08	0.83	0.80
3/4	1.04	1.33	1.16	1.08
7/8	1.26	1.61	1.39	1.22
1 1/16	1.48	1.91	1.66	1.49
1 1/8	1.77	2.25	1.95	1.78
1 1/4	2.03	2.60	2.25	2.08
1 1/2	2.34	2.99	2.61	2.41
1 3/8	2.65	3.40	2.94	2.77
1 1/2	3.00	3.83	3.31	3.14
1 5/8	3.38	4.30	3.71	3.54
1 3/4	3.75	4.80	4.15	3.98
1 7/8	4.15	5.31	4.59	4.42
2 1/8	4.57	5.86	5.08	4.91
1 3/4	5.01	6.43	5.35	5.23
1 7/8	5.52	7.03	6.06	5.89
1 3/4	6.00	7.63	6.62	6.45
1 7/8	6.55	8.31	7.76	7.59
2 1/8	7.05	8.98	8.31	8.13
1 3/4	8.18	10.41	9.00	8.83
1 7/8	9.38	11.93	10.32	10.15
2 1/8	10.71	13.60	11.75	11.58
2 1/4	12.05	15.40	13.43	13.26
2 3/8	13.60	17.20	15.20	15.03
2 1/2	15.10	19.20	17.20	17.03
2 3/4	16.68	21.20	19.20	19.03
2 5/8	18.30	23.50	21.20	21.03
2 3/4	20.18	25.70	23.50	23.33
2 7/8	22.06	28.20	25.70	25.53
2 3/4	24.10	30.60	28.20	28.03
3	33.20	30.60	30.43

Note: The size of the hole in hollow steel is assumed for purposes of calculation at 3/4 in. Actually it varies with size of drill and specification.

strong and should not impinge on a part of the drill so as to cause local overheating; (3) that the bit and some of the shank be well bedded in the coal or charcoal and not in a thin bed of hot cinders; (4) that the drill should be constantly turned in the fire. If these rules are not carefully followed the steel will be "burned," which means simply that some of its carbon will be oxidized. The heating should be uniform, and to secure uniformity the blacksmith turns the drill over in the fire.

When the bit has become a dull cherry red it should be removed with as little delay as possible and dressed. If the corners of the bit are badly worn the chisel edge must first be upset (blunted) to give the proper width; then the drill is held on the anvil at a slope of about 1 ft. rise to 2 ft. horizontal, the edge of the bit being even with the edge of the anvil. In this position it is hammered, giving a few blows on one side then turning it over for a few blows on the other side, and repeating until a new cutting edge is made.

A file may be used (while the bit is still hot) for the final shaping. If the drill is simply dull it is not necessary to "upset" it, but when taken from the fire it is tapped or brushed to remove any cinders, laid on the anvil and struck with light glancing blows until an edge has been formed. The blows should be glancing, so as to draw the steel fibres toward the cutting edge, and the lighter the blows that will accomplish this result the tougher the steel becomes.

The hammering is continued until the bit is nearly cold. Steel is improved by hammering, differing from iron in this respect. After once flattening the bit, do not attempt to hammer it back to a square or a round.

The width of each bit should be carefully gaged, for nothing is more exasperating to the drillers than to have a careless blacksmith send out bits irregular in width from ear to ear.

Inasmuch as different steels require heating and tempering in different ways, the blacksmith should be given only one grade of steel to work with at one time. It is also desirable that he should have but one shape of bit to sharpen at one time if his work is to be efficient.

The bit after being shaped must be reheated near the cutting edge for tempering. The heating is done in the forge, as before, until the bit is cherry red, when it is immediately plunged into water for a moment and moved about to cool it somewhat, and then rubbed on a stone or sand board to remove the scale, so that the play of colors may be readily seen in the dark corner of the shop. The light should preferably enter the shop from the north. Steel appears hotter the darker the shop, so the light

DRILL BITS: SHAPE, SHARPENING AND TEMPERING 53

should not vary much. The colors indicate approximately the following temperatures:

Very pale yellow	430° F
Straw	470°
Brown	490°
Purple	530°
Full blue	560°
Dark blue	600°

As the drill cools the colors should advance parallel to the cutting edge if the cooling is uniform; if otherwise, that side of the bit on which the colors are advancing most rapidly should be held in water. This plunging into the water is sometimes repeated several times before the colors move parallel with the edge of the bit.

If the colors flow rapidly to the cutting edge the bit has not been cooled sufficiently. Finally, when the colors move parallel with the edge and slowly, watch the edge closely until it is straw color and plunge into water a short distance, waving it back and forth (to insure rapid cooling) until the steam ceases to form; then leave it in the quenching bath. The quenching bath should be a tub large enough to cool the drills without raising the temperature of the water sensibly. Some of the baths commonly used are brine (1 quart of salt to 10 quarts of water), rape-seed oil, tallow and coal tar; the brine cools the drill fastest and the coal tar slowest.

The higher the temperature of the bit before cooling, the harder and more brittle the steel becomes. A bright red is about 1000 degrees F.; a dark red is about 900 degrees F. If bits chip or break in use, the temperature has been too high. For drilling very hard rock temper the bit at a lower temperature than straw color (470 degrees).

If soap is rubbed on the drill bit no scale forms after quenching.

Grades of Steel. The cheaper grades of drill steel are used almost exclusively; the high grade brands of bar and cruciform steels require to be forged and dressed at low heat; and, even when properly dressed and tempered, wear as fast as the low priced drills. The latter, while they can be forged at a much "softer heat," will not stand excessive upsetting, and it is often good practice to weld on short lengths of heavy steel to form the bit.

Hollow steel bits are more difficult to temper than solid steel.

Sharpening Machine Drill Bits. The ordinary + or X bit used in machine drills usually receives treatment somewhat different from that just described, partly due to its shape and partly due to the greater mass of metal in the bit. The bit is first shaped by a special set of blacksmiths' tools, shown in Fig. 10, consisting of BT1 and BT2, "dolly"; BT3 and BT4, "spreaders";

BT5, "sow"; BT6, "set hammer"; and BT7 and BT8, "swage."

The best blacksmith that I have had makes a "dolly" for each size of bit. To do this he heats a block of steel, and drives against it a cold drill bit of the exact shape and gage desired, thus producing what he terms a "female bit," which is afterward tempered hard. The "female bits," or dies, of different sizes are fastened to the anvil so that a hot bit which is to be shaped can be held horizontally and hammered into the die. The result is that all bits are rapidly made true to gage and well shaped.

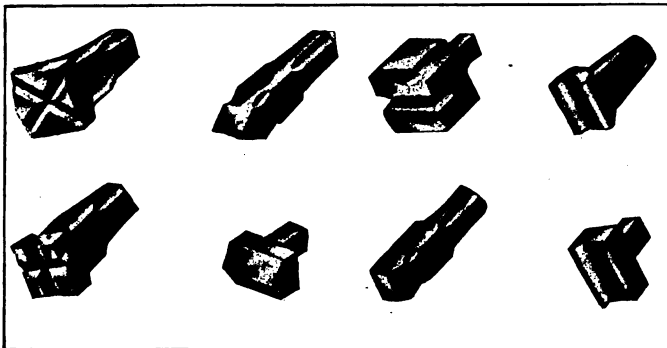

Fig. 10. Blacksmith's Tools.

Top Row, BT 1—3—5—7. Bottom, BT 2—4—6—8.

After shaping the bit is reheated for tempering, and at the proper temperature is placed in the cooling bath. Fig. 11 shows a cooling bath in which a grate or screen is placed $\frac{3}{4}$ in. below the water surface to support the bit until it is cool. A rack built around the tank, with nails 3 in. apart, holds the drills upright. The hot steel above the water line prevents the chill from reaching up to the water line, so that only the face of the bit is hardened. The mass of metal in the bit and the fact that at each resharpener the water line is higher up on the drill (due to wear of bit) eliminate danger of cracking at the water line. When this method of cooling is used the edges of the bit should be perfectly straight and not rounding. A bit immersed for a short time, and then withdrawn for annealing, is apt to be soft centered, due to the fact that the center cools more slowly than the corners.

In Using a Cooling Bath. When machine sharpening is pursued in tempering bits, it is usually necessary to use a cooling bath having a greater depth of water above the grate than would be required under hand sharpening conditions. This is due to

the fact that it is difficult to keep the water as cool with the faster sharpening done with the machines, than when work is done by hand. Care must be taken not to have the water too

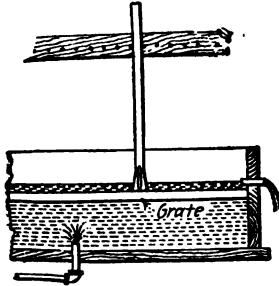
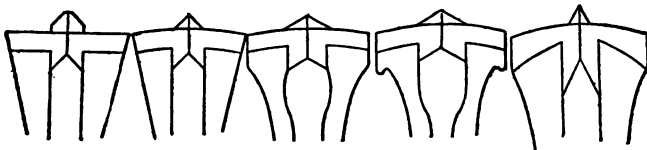

Fig. 11. Cooling Bath.

deep, because, with the bit in water an inch in depth, the large mass of metal in the center cools more slowly than the corners or wings since the corners have three sides exposed to water. If the center has not chilled at all when the bit is withdrawn for annealing the result is a softer bit center, which will flatten and retard the work of drilling.

Fig. 12, according to Proske, shows the evolution of the cross-bit where hand sharpening is employed. There are two systems of hand sharpening. One is known as the "set hammer system," in which the steel is hammered by placing a set-hammer on the bevels and driving the steel back. The results of this method are illustrated in Fig. 12. Fig. 12A shows bits made by cutting the bevels with a chisel and is as it should be in form.



A B C D E
Fig. 12. Distortion of Bit by Improper Sharpening.

Fig. 12B shows this bit after about the third sharpening. Fig. 12C is the same bit after about the sixth sharpening, and Fig. 12D is the same bit at about the time that the original cross that was formed on the bar of octagon steel has become exhausted.

The other system of hand sharpening is known as the "fuller-and-dolly system," in which the stock is first drawn sharp at the corners as shown in Fig. 12E with the fuller, after which it should be set back in the center with the dolly. Unfortunately the man swinging the sledge hammer gets tired before the bit is set back enough, with the result that the bit, partly finished, is left as shown in Fig. 12E. It is because the power sharpener has the staying power, and because it readily finishes a bit perfectly, that inferior bits like these are not to be found where machine sharpening is employed.

Cost of Sharpening Bits by Hand. One blacksmith with a helper will sharpen about 140 bits per day, and under ordinary conditions, will keep 5 to 7 drills supplied with sharp bits. In average rock a bit must be sharpened for every 2 ft. of hole; in very soft rock a bit for every 4 ft.; and in very hard rock a bit for every 1½ ft. of hole. On small jobs it is often necessary to have a blacksmith, even though there is only one drill at work. In such cases, however, the blacksmith should be kept busy with other work.

In general, sharpening machine drill bits by hand costs \$3 for blacksmith's wages, \$2 for helper, and 60 ct. for charcoal, or 4 ct. per bit.

Mr. Edward D. Self, Manager and Engineer San Carlos Copper Co., San José, Mexico, wrote me that 185,828 hand drills were sharpened in drilling about 65,000 ft. of hole, at a cost of 2 ct. per bit (Mexican currency); and that 10,000 machine drills bits were sharpened by hand at a cost of 3 ct. each (Mexican currency).

4 **Machine or Power Sharpening.** For sharpening large numbers of bits daily, drill sharpening machines are much cheaper than hand sharpening. Within the last ten years machines for sharpening drills have come into use on work where there is much sharpening to be done. There are a number of these machines on the market, among which are the Word, Ajax, Imperial, Leyner, etc. In general, these machines consist essentially of two air-driven hammers, one hammer working horizontally, the other working vertically. See Fig. 13.

Mr. Robert A. Kinzie informs me that the Alaska Treadwell mines use Ajax drill sharpeners, and that one machine sharpens 460 bits per shift. The first Word drill sharpeners were used at the Franklin copper mine, near Houghton, Mich., and at the Black Oak mine, Lousbyville, Cal. Mr. W. G. Scott, superintendent of the Black Oak mine, is quoted in the *Mining and Scientific Press*, April 11, 1904, as follows:

"The machine ran 183 days with nominal repairs. Average hours run daily, 4; total, 732 hours. One man operated the

drill, attended his own forge and made necessary repairs. Any man who can set up and run a machine drill can run the drill sharpener. Approximate number of drills upset and sharpened, 36,000; average, 50 drills per hour. Fuel used is less than one-half that required in hand work. One and one-half minutes are required to form and sharpen a new drill. Over 60 drills have been repointed by this machine in one hour. The life of a bit sharpened by this drill is longer than when done by hand, the bits being better formed and more compact, taking a better and more even temper. The different-sized points are made with uniformity. By a change in the dies the machine will sharpen hand drills. Before we used this machine we employed two drill-sharpening blacksmiths and two helpers to make and sharpen drills. The saving of the machine over hand labor in six months has been \$1,738; saving on coal (183 days), \$183; or a total saving for six months of \$1,921."

The Sullivan sharpener consists of two members, one horizontal, the other vertical, both mounted on a substantial box shaped frame. These members consist of Sullivan $2\frac{3}{8}$ -in. rock drill cylinders, with standard "Liteweight" or differential air thrown valve motion. The horizontal drill or hammer is used for upsetting the steel into the shape of the bit or shank, by means of suitable steel dollies, loosely mounted on the end of the shank or piston rod. In this hammer, the piston is a floating one, as in a hammer drill, and delivers its blows on the upset anvil block-head of the projecting piston rod.

The vertical member furnishes power for shaping the wings of the bit, etc., and for drawing out and finishing the corners. This work is done by steel dies, one acting as an anvil, and the other, attached to the piston rod above, as a swage or hammer. The vertical hammer is operated by a foot lever, which is ordinarily held up by a coil spring. This spring also serves to hold up a release pin, running through the lower valve bushing, and in turn holding the valve away from the lower seat, so that the piston is always held at the upper or rear end of the cylinder, by live air, when the hammer is idle. When the foot treadle is depressed, the pin drops, allowing the valve to seat, and the hammer to start.

The steel is held in position while being upset by steel gripping dies set in a heavy vise, which is operated by air power. This vise simply grips the steel, the forming being done altogether by the upsetting dolly and hammer.

The vise and the upsetting hammer are operated by one hand lever, the valve motion being so controlled that as the handle is depressed, the vise is closed before air is admitted to the upsetting cylinder. Further depression starts the hammer re-

The other system of hand sharpening is known as the "fuller-and-dolly system," in which the stock is first drawn sharp at the corners as shown in Fig. 12E with the fuller, after which it should be set back in the center with the dolly. Unfortunately the man swinging the sledge hammer gets tired before the bit is set back enough, with the result that the bit, partly finished, is left as shown in Fig. 12E. It is because the power sharpener has the staying power, and because it readily finishes a bit perfectly, that inferior bits like these are not to be found where machine sharpening is employed.

Cost of Sharpening Bits by Hand. One blacksmith with a helper will sharpen about 140 bits per day, and under ordinary conditions, will keep 5 to 7 drills supplied with sharp bits. In average rock a bit must be sharpened for every 2 ft. of hole; in very soft rock a bit for every 4 ft.; and in very hard rock a bit for every $1\frac{1}{2}$ ft. of hole. On small jobs it is often necessary to have a blacksmith, even though there is only one drill at work. In such cases, however, the blacksmith should be kept busy with other work.

In general, sharpening machine drill bits by hand costs \$3 for blacksmith's wages, \$2 for helper, and 60 ct. for charcoal, or 4 ct. per bit.

Mr. Edward D. Self, Manager and Engineer San Carlos Copper Co., San José, Mexico, wrote me that 185,828 hand drills were sharpened in drilling about 65,000 ft. of hole, at a cost of 2 ct. per bit (Mexican currency); and that 10,000 machine drills bits were sharpened by hand at a cost of 3 ct. each (Mexican currency).

4 **Machine or Power Sharpening.** For sharpening large numbers of bits daily, drill sharpening machines are much cheaper than hand sharpening. Within the last ten years machines for sharpening drills have come into use on work where there is much sharpening to be done. There are a number of these machines on the market, among which are the Word, Ajax, Imperial, Leyner, etc. In general, these machines consist essentially of two air-driven hammers, one hammer working horizontally, the other working vertically. See Fig. 13.

Mr. Robert A. Kinzie informs me that the Alaska Treadwell mines use Ajax drill sharpeners, and that one machine sharpens 460 bits per shift. The first Word drill sharpeners were used at the Franklin copper mine, near Houghton, Mich., and at the Black Oak mine, Lousbyville, Cal. Mr. W. G. Scott, superintendent of the Black Oak mine, is quoted in the *Mining and Scientific Press*, April 11, 1904, as follows:

"The machine ran 183 days with nominal repairs. Average hours run daily, 4; total, 732 hours. One man operated the

DRILL BITS: SHAPE, SHARPENING AND TEMPERING . 57

drill, attended his own forge and made necessary repairs. Any man who can set up and run a machine drill can run the drill sharpener. Approximate number of drills upset and sharpened, 36,000; average, 50 drills per hour. Fuel used is less than one-half that required in hand work. One and one-half minutes are required to form and sharpen a new drill. Over 60 drills have been repointed by this machine in one hour. The life of a bit sharpened by this drill is longer than when done by hand, the bits being better formed and more compact, taking a better and more even temper. The different-sized points are made with uniformity. By a change in the dies the machine will sharpen hand drills. Before we used this machine we employed two drill-sharpening blacksmiths and two helpers to make and sharpen drills. The saving of the machine over hand labor in six months has been \$1,738; saving on coal (183 days), \$183; or a total saving for six months of \$1,921."

The Sullivan sharpener consists of two members, one horizontal, the other vertical, both mounted on a substantial box shaped frame. These members consist of Sullivan 2½-in. rock drill cylinders, with standard "Liteweight" or differential air thrown valve motion. The horizontal drill or hammer is used for upsetting the steel into the shape of the bit or shank, by means of suitable steel dollies, loosely mounted on the end of the shank or piston rod. In this hammer, the piston is a floating one, as in a hammer drill, and delivers its blows on the upset anvil block-head of the projecting piston rod.

The vertical member furnishes power for shaping the wings of the bit, etc., and for drawing out and finishing the corners. This work is done by steel dies, one acting as an anvil, and the other, attached to the piston rod above, as a swage or hammer. The vertical hammer is operated by a foot lever, which is ordinarily held up by a coil spring. This spring also serves to hold up a release pin, running through the lower valve bushing, and in turn holding the valve away from the lower seat, so that the piston is always held at the upper or rear end of the cylinder, by live air, when the hammer is idle. When the foot treadle is depressed, the pin drops, allowing the valve to seat, and the hammer to start.

The steel is held in position while being upset by steel gripping dies set in a heavy vise, which is operated by air power. This vise simply grips the steel, the forming being done altogether by the upsetting dolly and hammer.

The vise and the upsetting hammer are operated by one hand lever, the valve motion being so controlled that as the handle is depressed, the vise is closed before air is admitted to the upsetting cylinder. Further depression starts the hammer re-

reciprocating. The vise valve rod contains a link and coil spring which holds the valve in position to keep the inlet port to the upsetting cylinder closed when the machine is idle. In stopping the machine, the lever is raised, first shutting off air from the upsetting hammer and, when this has stopped, opening the vise.

The operating levers are so placed that the smith uses them conveniently with his left hand and left foot, bringing his right hand at a proper point to handle the steel readily. The absence of a long carriage and tail block to hold the steel in position is a saving in floor space and in labor.

In sharpening new steel, the operator clamps the stock in the vise, upsets it slightly with a few blows from the horizontal hammer, then releases it, and begins to draw out the wings under the vertical hammer. This is so arranged that slow, heavy blows, or light rapid ones can be struck. The steel is thus alternated until sufficiently upset and proper gage and angle given the cutting edges, when the corners are finished by the vertical dies. It is customary to make complete perfect bits from blank, raw bar steel in one heat in the Sullivan sharpener, and while daily or monthly records are dependent on other things besides the machine, a blacksmith can finish new bits, with a little practice, in 50 sec. to one minute each.

Bits of any form and gage may be made on this machine, on steel of any shape, solid or hollow; and shanks also may be formed to order, providing proper dollies and dies are furnished. The collared shanks on hollow steel for rotators or hand feed hammer drills, and the lugged shanks for mounted water jet hammer drills are two forms that are made economically and rapidly on this machine.

Mr. T. H. Proske is authority for the following comparative costs of hand and machine sharpening at the Homestake Mine:

Hand sharpening:	
Blacksmith, 10 days	\$35.00
Helper, 10 days	30.00
Total labor	<u>\$65.00</u>
1,200 lb. of coal	7.20
Total for 1,200 drills at 6c.	<u>\$72.20</u>
Machine sharpening:	
Air for one machine, per day (two shifts)	\$ 2.00
2 blacksmiths, \$7; 2 helpers, \$6	13.00
2 blacksmiths sharpening block hole steel	7.00
2 extra tool packers	6.00
720 lb. coke	4.75
Fire bricks to repair furnace	0.20
Total for 1,000 drills at 3.3 ct.	<u>\$32.95</u>

Mr. A. W. Warwick states that the drills used in driving the *Cripple Creek* Drainage Tunnel were sharpened with a Leyner

drill sharpener. This sharpener turned out 150 bits a day. Two blacksmiths were employed during the day shift, one for welding and one for sharpening. The welder by means of a small steel hammer could weld enough steel for the entire 24 hours, so that the night shift needed only one sharpener.

The price of a drill sharpener ranges from \$300 to \$1200.



Fig. 13. Machine or Power Sharpener.

Fuel for Forges. Ordinary coal should never be used for heating drills, or for any work around a forge. Charcoal is generally considered the best fuel for a forge, but many prefer coke or "blacksmith's coal." Coal which contains sulphur is very harmful to a bit because it makes it brittle when hot or "hot short." Coal containing phosphorus will make a bit brittle when cold or "cold short." A good coal for use in forges should have a high heating power, be low in ash, and coke enough to form an arch over the fire.

Oil and electricity are sometimes used for heating drills, but for general use in forges oil gives too large a flame, and electricity is suited only for particular situations as it requires the use of a special forge.

A bit should never be put into a new or "green" fire, as the steel will be heated unequally and the impurities driven off the fresh fuel will affect the steel. Bits should always be cleaned of mud and grit before they are heated, as impurities are bound to affect the steel. Shade the bit from the direct rays of sunlight as steel never appears as hot in sunlight as it really is

and a badly burned bit is likely to result. A "dirty" fire is generally the result of impurities in the fuel, and, if the fuel is coal, these impurities may cause a clinker, or the slaty particles may lodge in the way of the blast. A dirty fire can also be caused by an accumulation of ashes or burned-out coke. When using coke always clean the fire entirely out after each operation.

Cost of Fuels for Forges. Tests with various fuels for forges were made at the mines and smelters of the Mammoth Copper Co., to determine which fuel was the cheapest to use. The results as taken from the *Engineering and Mining Journal* are given below. Coal, coke and oil were tried. Oil proved to be the cheapest at the smelter, and also at the mine where it was used for heating steel for the drill sharpeners and coal was found to be cheapest in the ordinary blacksmith work.

The oil heats steel and iron quickly, but an undesirable feature is the roaring noise caused by the compressed air used to atomize the oil. For general blacksmithing, such as bending, the oil gives too large a flame, but when a large area is to be heated it is superior to other fuel. Most smelter work requires a flame heating a large area, while the reverse is true for most mine blacksmith work. Moreover, at the smelter, as there is considerable work to be done, there are usually several forges in use and the number of forges that are kept running is adjusted to the amount of work, so that a forge is kept in operation as continuously as possible. This makes the wear and tear on the oil-fired forge considerable. At the mine there is generally not enough work to keep one forge going all the time. The consequent alternate cooling and heating plays havoc with the firebricks in the bed of the forge. This is the main expense in the maintenance of an oil-fired forge.

At the smelter blacksmith shop the use of oil has resulted in a saving of a third of the labor required to do the blacksmithing as compared with coal-fired forges, while the oil is also much cheaper. The following tables give the results of tests of the two fuels best adapted to the work in hand, which were made at the Mammoth mines:

Fuel cost for mine forge:	Coal	Oil
Number of shifts	75	28
Forges running per shift	4	2
Cost of fuel per shift per forge	\$0.69	\$0.867
Cost of repairs per forge per shift		0.185
		—
Total cost per shift per forge	\$0.69	\$1.052
Fuel costs of heating drills for sharpeners:	Coke	Oil
Number of nine-hour shifts	235	58
Amount of fuel used per shift	190 lb.	9.5 gal.
Drills sharpened per shift	429	312
Total cost of fuel per shift	\$1.26
Total cost of fuel per drill sharpened	\$0.003	\$0.001

DRILL BITS: SHAPE, SHARPENING AND TEMPERING 61

The test to determine the fuel cost for heating steel for the drill sharpener indicates that coke is better than coal; oil better than coke. The cost per drill heated with oil was 0.1 ct. and with coke 0.3 ct. For the mine forge, oil proved more expensive than good blacksmith coal, and the maintenance of the forges was much greater when oil was used.

The cost of the coal per forge per shift, with coal at \$22.69 per ton, delivered at the mine, was 69.1 ct., and for oil at 4.9 ct. per gal. at the mine, it is 86.7 ct. for fuel alone, while the repairs averaged 18.5 ct. per forge per shift, making the total cost of oil firing \$1.05 per forge per shift. The saving per forge per shift with coal was 36 ct.

There can be no question that in such work as sharpening steel, where an even temperature is essential to good work and the work is fairly continuous over periods of a few hours, oil is not only the cheapest but also the best fuel to use in bringing the steel to forging temperature.

Making Charcoal for Fuel. The following data are from experience on work in the south where hand drills were used in gneiss rock.

Owing to the fact that the price of coal was high and the hauling from the railroad cost from 50 to 60 ct. a 100 lb., the contractor used charcoal in sharpening his steel. One man was detailed to make the charcoal, and was employed continuously. He got the wood from the right of way, and, as he used up the wood at one place, moved his charcoal pits along the road bed.

He dug a pit, in which to do his burning, and cut up his wood in cord wood lengths. After getting his fire fairly hot he covered it over with stones and earth, which allowed the fire to burn slowly without dying out. In this way the wood was not consumed, but was burnt into a fair quality of charcoal. After it had turned into charcoal he uncovered it, and put the charcoal into sacks, carrying it to a shed adjoining the blacksmith shop. He did all the work himself and managed to keep enough charcoal on hand, even in bad weather, to run the blacksmith shop. At first he used only hard woods, such as oak, hickory, ash, etc., but it was evident that the supply would give out, so he mixed with it from $\frac{1}{4}$ to $\frac{1}{3}$ soft wood, hemlock and pine. This did not make as good a quality of charcoal, but it answered the purpose.

The blacksmith was a man who had been accustomed to sharpening drills for iron mining and had used charcoal before. The forge was built up of stone, with a duck's nest in it, and a 5-leaf bellows to furnish the draft. With charcoal the helper was needed to pump the bellows continuously when heating steel.

Cost of Blacksmith Shop Equipment.* Tools necessary for a blacksmith shop suitable for drill and general repair work.

1 anvil, 130 lb.	\$ 13.00
2 augers, ship, 1 7/8 in., \$1; 1-1 in., \$1.20	2.20
2 bevels, universal	2.50
1 bruce and 13 auger bits, 1/4 in. to 1 in. in roll	5.50
1 caliper, micrometer	6.00
4 calipers, spring, at \$1	4.00
6 chisels, cold, 1 1/2 lb. at 50 ct.	6.00
4 chisels, hot, 8 lb., at 50 ct.	4.00
1 cutter for pipe up to 3 in.	4.80
1 drill, stationary, hand power, 1/4 in. to 1 1/4 in. hole, weighs 170 lb.	22.00
1 drill, breast	3.00
6 drill dollies	10.00
24 files, assorted, at \$8 per doz.	16.00
24 files, flat, at \$8 per doz.	16.00
12 files, small taper	0.60
24 files, triangular, at \$7 per doz	14.00
1 grind stone, foot power, 3 in. x 12 in. wheel	4.00
1 gauge, marking	2.00
4 heading tools, 1 1/2 lb. each	3.00
3 hammers, blacksmith	2.70
3 hammers, set	1.50
4 hardies, at 50 ct. per lb.	2.00
2 puils at 70 ct.	1.40
6 rasps, at \$12 per doz.	6.00
1 rule, 6 ft., folding	0.40
1 saw, cross-cut, hand, 26 in.	1.35
1 saw set	0.70
2 saws, hack, at \$1	2.00
4 shanks	2.00
1 sledge, double face, 5 lb.	1.50
2 sledges, double face, 7 lb. each	4.20
1 sledge, cross pein, 5 lb.	1.50
2 sledges, cross pein, 4 lb. each	2.80
2 squares at \$9	18.00
1 stock and 8 dies for 1/2 in. to 2 in. pipe	17.50
8 swedges, bottom, 1 lb. each	2.00
8 swedges, top, 1 lb. each	2.00
9 tongs, assorted	12.00
1 vise, blacksmith's leg, 6 1/4 in.	20.00
1 vise, hinged, for pipe, 1/8 in. to 3 in.	3.15
	<hr/>
	\$243.30

The use of Hollow Drill Steel for Certain Special Conditions: Mr. Chas. A. Hirschberg has published the following notes in *Mining and Engineering World*.

Self-Rotating Hand Hammer Drill Operated by Steam. In such work as shaft sinking in loose covey material, some operators have experienced trouble due to the chocking up of the hole in the steel and have employed the following means for overcoming the difficulty: A standard 6-point bit was altered as shown in Fig. 13A. The hole in the steel, instead of being carried directly through the center of the bit, was punched through the side about 5/8 to 3/4 in. above the cutting edge—the bit itself being forged solid, the hole coming out between the wings.

The clearance of the bit was also increased by cutting out the

* From "Handbook of Construction Plant," by Richard T. Dana.

metal between the wings, back to the base of the bit or to the normal diameter of the steel. This reconstruction of the 6-point bit permitted it to accommodate itself to the water of condensation and mudding effects. Still another bit that was found of great service in almost identical conditions of drilling was a "V" shaped bit as shown in Fig. 13B. The cutting edges

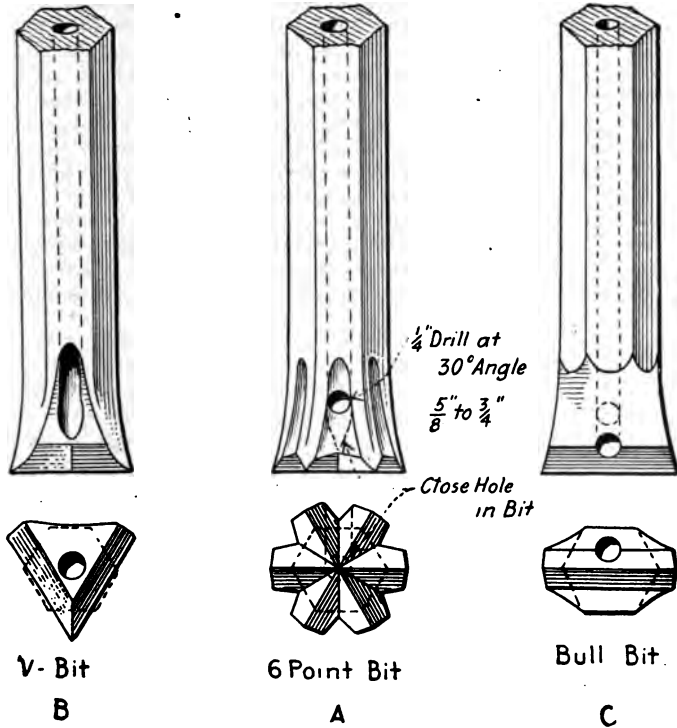

Fig. 13. Special Hollow Steels.

consisted of two straight edges, meeting at a point and open at one side similar to a "V," the metal between these cutting edges being cut well back and the hole carried straight down.

Another illustration of the value of a bit specially created for the job is demonstrated in the sinking of a shaft in Colorado through sand rock and blue shale. This ground was found to give particularly bad mudding and had a tendency to cement. Various bits were tried and while it was found that the ordinary

form of chisel bit with a single cutting edge gave satisfactory results, further experiments led to a change consisting of carrying the hole in the steel out at the side (Fig. 13C) instead of through the end. With multiple cutting-edge bits it was found that the steel would jam in the hole and a great many holes and steels were lost, whereas the chisel or flat bull bit could readily be removed and drilled equally as fast in this rock.

James A. McIlwee in commenting on the results obtained by him with Jackhammers in the sinking of a shaft in Utah, stated, that if machines of this class are not mudding properly the difficulty can often be overcome if the operator will occasionally raise the machine and steel so that the bit is about 6 in. from the bottom of the hole; this will permit the air to blow through the steel and remove the mud from the bottom of the hole. Especially in drilling deep holes was this practice followed. He found that the "rose" or 6-point bit was a failure in this shaft, whereas a cross 4-point bit with a liberal clearance between wings turned the trick. The ground in this case was hard quartzite, and it was necessary to temper the steel in cyanide of potassium so as to protect the corners.

In further commenting on this job Mr. McIlwee stated: "We used four machines in sinking this shaft 500 ft. We had a 6-way manifold on the end of the air line, one for the pump, four for the drills and one for a blow pipe. An extra hose with a small $\frac{1}{2}$ -in. blow pipe 6 ft. long was kept in the shaft at all times, and when the holes were being drilled through gravelly ground, and the machines refused to throw the mud out, we would take the drill out and send the blow pipe to the bottom and give the hole a blowing out. By doing this for every 12 to 18 in. we easily drilled 7-ft. cut holes."

The Use of Blunt Steel. In the southwest there are a great many self-rotating hand-hammer drills operating by steam, in soft rock, and occasional trouble was experienced until a suitable bit had been found. In one very puzzling case where the rock was a very soft limestone, 6-point bits were at first tried, but as satisfactory results could not be obtained, the standard 4-point cross bit was resorted to, and while considerable improvement was noted, it was felt that the results could be improved upon. The cross bits were made and then blunted to retard the cutting action and this successfully solved the problem. In rock as soft as that in question, sharp 6 and 4-point bits drill too rapidly, causing the cuttings to wedge around the steels just above the bits and interfere with rotation.

In drilling out an old concrete foundation containing about 2000 cu. yd. of material, the practice followed by a contractor was as follows: Holes were drilled to a depth of 30 to 36 in.

about 15 in. apart, 15 in. from the edge, 10 to 12 holes in a row. Two feet half-round feathers about $\frac{1}{4}$ in. thick were used and a 4-ft. pointed steel wedge about $1\frac{1}{4}$ in. thick was driven into each of the holes drilled and slabs of concrete broken off. The wedges were driven in all at one time by men with sledges. Drilling was all done without change of steel and no special starters were employed. In starting this work "rose" bits were at first used, but as it was found that fragments of concrete and pebbles would wedge between the wings of the bit, and inter-

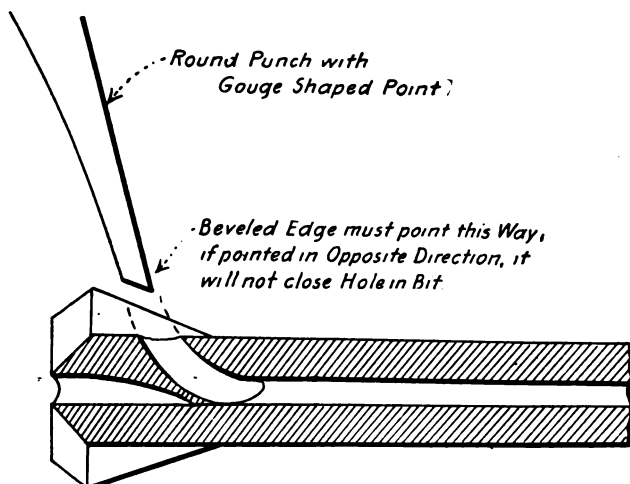

Fig. 13D. Punching the Hole in the Side of Hollow Steel.

fered with the free rotation of the drill steel, cross bits with broad exit passages between the wings were resorted to.

In the shaft of the Butte-Alex. Scott Copper Co. which was driven through hard and almost dry granite, 18 to 22 holes, 5 to 6 ft. deep, were drilled in $3\frac{1}{2}$ to 4 hours' time, including the time consumed blowing holes out and blasting, and during March of the year 1915, 101 ft. of shaft were broken, although operations were not conducted during 17 shifts of the month. Here difficulty was experienced in keeping the hole in the steel open, and the same method resorted to as that already described to overcome the difficulty. The hole was drilled in the hollow steel at a point 2 to 3 in. above the end of the bit, and the mining company states that they are able to drill 7-ft. holes, and but very seldom experience trouble from plugged steels.

Fig. 13D shows the manner in which the hole is punched in the side of hollow-drill bits and the style of punch used in doing the work. The punch is dressed as shown at the top makes the job easy of accomplishment and insures the closing of the hole in the end of the bit. The hole is punched part way and the punch withdrawn and cooled in water. It is then inserted once more and becomes sufficiently heated by the time it reaches the natural hole in the steel to take on a slight curvature. The beveled edge of the punch leads it into the hole as shown, forcing the metal just forward into the hole that leads out the end.

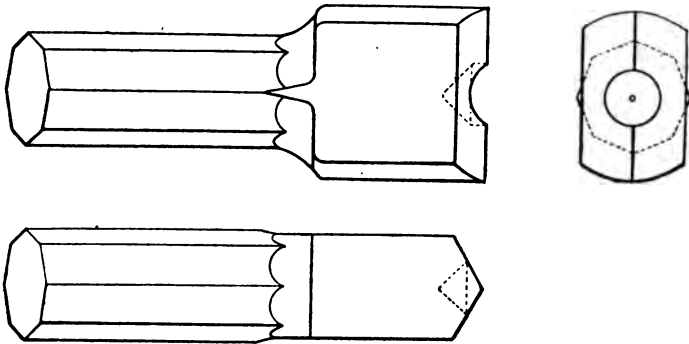

Fig. 13E. The Carr Bit.

Carr Bits. A recent contribution to the solution of the drill bit problem is that of the Carr bit. (Patents owned by the Ingersoll-Rand Co.) This bit while designed primarily for overcoming certain difficulties in drilling rock, has been found to meet satisfactorily, not only these special conditions, but the ordinary conditions as well. The Carr bit (Fig. 13E) has but a single cutting edge and is uniform and symmetrical in shape. A transverse recess is formed across the center of the bit. With hollow steel this recess is tapered until it runs into the original hole through the steel. With solid steel the recess extends back about $\frac{1}{2}$ in. from the face. This recess tends to act as a pilot, and reduces the cutting or contact surface with the rock to a minimum. The thickness of the bit is made equal to the short diameter of the steel and the length equal to the bit gauge. Hollow drill steel bits are conical in shape and have a 5° taper on a side. Solid steels have straight, parallel, cylindrical sides.

The advantages claimed for the Carr bit are: It holds its gauge better than the bits familiar to the trade; thereby increasing the depth to which a hole may be drilled before having to

DRILL BITS: SHAPE, SHARPENING AND TEMPERING 67

change steels. This reduces the number of steels dulled per shift. It drills a round hole and rotates easily. It does not require more than $\frac{1}{16}$ in. variation in the gauge of bits on successive lengths of steel, thus avoiding the use of large diameter bits and therefore reducing the amount of rock to be cut. The bit is very simple in form and very easily made, either with hand tools or in the patented Leyner sharpener equipped with Carr dies.

The record of experience shows cases where holes have been drilled with a single Carr-bitted steel to a depth of 16 ft. through very hard rock, with soft seams running almost parallel with the hole being drilled, but with pitch enough to cross the line of the hole at a bad angle. The size of bit used was $1\frac{3}{4}$ in. on $1\frac{1}{4}$ in. round, hollow steel, and lost but very little of its gauge.

The idea of drilling a hole the same size from the collar down to the bottom originated with the inventor from the discovery that a drill bit cuts a margin of clearance for itself, so that the problem became one of designing a bit that would effectually resist loss of gauge, would drill a round hole and cut rapidly.

To insure the drilling of a round hole the shape of the bit was made such that it would be impossible for it to go down if the hole were not round. The next problem was to overcome the loss of gauge. This was done by providing the long shoulders, curved concentric with the axis of the bit. This combined with the other feature necessary in drilling the round hole formed a large area on the shoulders. The hole being round, and the bit being round, it simply rotates in the hole like a shaft in a boxing. Rapid cutting speed was assured by forming the transverse recess in the center of the bit, for the purpose of reducing the area that comes in contact with the rock.

After the above had been done, it was discovered that the harder the blow delivered to the steel and transmitted to the rock, the larger would be the hole cut by the bit. This was overcome by making the bit more blunt, or with less cutting edge pitch, and it was then discovered that the blunt bit would cut faster than the sharper pitch, as it would reduce the rock in the bottom of the hole by crushing a larger area and absorbing absolutely all of the blow to advantage, as there would be no slipping or sliding off of knots or lumps in the bottom of the hole.

A test of the Carr bit by the Alaska Treadwell Gold Mining Co. with a Bull Moose type of Jackhammer, as against the cross bit with the same machine, showed about 20% more drilling for the Carr bit, while on the regular Jackhammer the Carr bit did about a third faster drilling than did the Cross bit under identical conditions.

CHAPTER IV

MACHINE DRILLS AND THEIR USE

Types of Power Drills. Drills driven by power, as distinguished from drills driven by hand, may be classified as follows:

1. Steam Drill
 - (a) Percussive
 - (b) Cable
 - (c) Rotary
2. Air Drill
 - (a) Percussive
 - (b) Hammer
 - (c) Rotary
3. Pneum-electric Drill
4. Electric-Air Pulsator Drill
5. Gasoline-Air Pulsator Drill
6. Electric Drill
 - (a) Percussive Motor
 - (b) Hammer Motor
 - (c) Solenoid
7. Gasoline Drill
8. Water Drill
 - (a) Hammer
 - (b) Rotary

Steam Drill of the "percussive" or reciprocating type is a small steam engine to the piston rod of which a drill rod is fastened by a "chuck." This is the original type of power drill. A drill of this type may also be operated by compressed air.

Cable Drill is a churn drill that is raised by a cable and allowed to fall freely like a pile driver. This type of drill was originally devised for well drilling but is now also used extensively for drilling blast holes in the softer kinds of rock.

Rotary Steam-Driven Augers are used for well drilling in earth and soft rock.

Air Drills are driven by compressed air. A "percussive air drill" is of the same design as a percussive steam drill. An "air hammer drill" does not have the drill rod fastened to the steam piston rod, but the drill head is struck by a hammer head on the end of the piston rod. Small hammer drills are called "plug drills."

Rotary Air Drills are air-driven augers, mostly used in coal mining.

Pneum-electric Drill is an air-driven hammer drill that receives its compressed air from a small, portable air compressor driven by an electric motor.

Electric Air Pulsator Drills are a combination of a simple percussive air drill and a "pulsator" or small air compressor geared to an electric motor, the combination being so designed that the compressed air is circulated continuously and not exhausted. A gasoline motor may be substituted for the electric motor and the drill is then called a "gasoline air drill."

Electric Drills are operated directly by an electric motor or by a solenoid. The drill is either percussive or hammer.

Gasoline Drill is a percussive drill, the piston of which is driven by gasoline.

Core Drills are discussed in Chap. VIII (a) Diamond; (b) Shot.

Recent Development in Rock Drill Design and Construction.*

The great change which has taken place in the last few years in rock drill design and construction is not well realized by engineers not directly connected with rock excavation. A classification of rock drills as they are used today is given as follows by Mr. W. L. Saunders in a paper before the American Institute of Mining Engineers:

(1) The plugger drill. This is of the hammer type. It is used in its smallest sizes for dressing stone, for trimming, cutting hitches, and for block holes. It is a hand-rotated machine.

(2) The Jackhammer. A hammer drill with automatic rotation, used for sinking shafts, for down-hole work in stopes, for quarrying, for drilling in coal, and in rock and ore work wherever down-holes are required. It is held in the hand of the operator and in some mines is used for horizontal work, mounted upon some simple form of support.

(3) The stoper. A hammer drill with air feed, usually used without mounting and for up-holes. It has a large field of usefulness, mainly in stopes or rooms and in driving raises.

(4) The mounted hammer drill, as exemplified in the Leyner type, used mainly for horizontal, or approximately horizontal, hole drilling, for side stoping, and for driving drifts and tunnels. In this type of drill a combined stream of air and water is discharged through a hollow steel at the bottom of the drill hole.

(5) The reciprocating drill used for heavy down-hole drilling where the stopes are large, and for surface work, drilling deep holes of large diameter.

* *Engineering and Contracting*, Oct. 8, 1913.

The evolution of these new forms of drills, their recent perfection of construction and particularly their economies are summarized by Mr. Saunders as follows:

In the last two or three years the study of rock drill economics has been pursued so vigorously and so successfully that in design, material, and workmanship the rock drill of today is a superior machine, doing more work, standing up to its work longer and better adapted to conditions heretofore unknown than the machines of the past. Lighter in weight, and more easily handled by the operator, it is an aid to the miner in very materially reducing the cost of ore per unit of labor, repairs, and power consumption. There has in fact been an evolution in the rock drill from a piece of steel with a bit on the end of it, struck by the hand of an operator, to a similar piece of steel struck by a power hammer. Between these two extremes we have seen the jumper, the hand-operated drill, and the power-driven machine, which started with the cumbersome rock drill of J. J. Couch, about 1850, followed by the reciprocating machine of Joseph W. Fowle a few years later, Fowle's original idea of the cutting tool being an extension of the piston rod continuing to hold supremacy in many simplified forms up to a very recent period.

It is interesting to follow the evolution of the percussive type of rock drill. We must bear in mind that there are two distinct types of power-driven machines—the reciprocating and the hammer drill. Fowle's first machine was mounted upon wheels and weighed several thousand pounds. The Burleigh drill, which was a development of Fowle's invention, Burleigh having purchased the Fowle patents, was a machine mounted either upon a carriage or a tripod, but in any case it was difficult to get the weight below a thousand pounds. André in his admirable work on coal mining, published a generation ago, states that a machine rock-drill should be "simple in construction and strong in every part." He follows this with the statement that it should be "as light in weight as can be made consistent with the first condition." The problem in percussive drills has always been to reduce the weight, provided in so doing the strength of the machine is not brought below the breaking point. The struggle to reduce the weight at first met with considerable success when air pressures of from 40 to 60 lb. were in vogue. It was found, however, that it paid in mining work to use high air pressures and this at first interfered with the efforts made by engineers to bring down the weight. There was even a period, some 20 years ago, when some engineers advocated heavy rock drills as best and most efficient in the end. Successful *contractors* specified large machines, claiming that by their use

they were able to increase the air pressure, to get a heavier blow, to save up-keep expenses and to reduce the cost of excavation. Heavy drills invariably called for heavy mountings, and here is where an added difficulty was experienced, because heavy mountings were cumbersome underground, they were in the way, it was necessary to employ more men to handle them and they could not be used at all in narrow places. Here began the struggle for supremacy between the percussive and the hammer types—a struggle which has recently resulted in the adoption of the hammer type as the most useful drill for general mining purposes.

The mining drill at the present time is a machine which weighs from 60 to 150 lb. It is largely a one-man machine, though under many conditions of work it is still best to add a helper. The percussive or piston type still holds its supremacy for heavy work, even in mines where large stopes are encountered, as, for instance, at the Homestake, but this percussive drill is now a machine which safely withstands pressures of from 100 to 110 lbs. and its weight has been considerably reduced because of changes made in both design and material. This type of drill now used in the stopes at the Homestake weighs 137 lbs. unmounted, and mounted on column with arm about 375 lbs. Its work is chiefly in down-holes. Each part of the machine represents a study in material. The metal itself and the treatment it receives in the shops are both regulated in accordance with the work that each particular part has to perform. All our knowledge of metallurgy is taken advantage of in the construction of the drill. The cast iron is not ordinary cast iron. It resembles it only in that the metal is cast. The composition is made up to suit rock-drill service and the metal is treated with special reference to the work it is to do. The steel is not common steel, but it is alloyed to suit each particular part. It receives a hot, crude oil bath and it goes through many processes before it is finally coupled up with the other parts into a complete drill. Special metal and special treatment are not confined to the piston or percussive type, but they apply equally to the hammer type. In fact, it was because of the necessity for lighter weight and greater strength in the hammer type that the study of the metallurgy of the rock drill was initiated and carried to a successful issue.

The first great improvement made in the piston or percussive type has been in the metal used, and this has resulted in greater strength, greater durability, and a lighter weight of machine for higher pressures. There has also been a change in design, which in the main has been confined to the valve motion. The chief aim of the designer has been to get greater speed. This means

a greater number of blows, and in order to do this valves have been provided which open and close quickly and which have large ports. It is obvious that, other things being equal, a piston type of drill of large piston area will do more work than the same type of drill with a smaller area. The larger machine, which drills more, is handicapped by its weight, and when the net efficiency is figured up it has been found that it sometimes pays to get less drilling capacity with a machine which is more readily handled. Here the question of upkeep is introduced, because generally speaking the heavy type of machine costs less for repairs than the lighter type. The designer, taking all these things into consideration, has sought to increase the diameter of the piston so as to provide the drilling capacity of the heavy type with a machine of considerably less size and weight. This has in a measure been accomplished by the use of superior material and a design which shortens the piston, putting the extra bearing into the front head, where it is lighter. Through the use of a type of valve known as the butterfly a quick opening of large area is provided, thus increasing the number of strokes and thereby bringing up the drilling capacity. This has been done with no increase in air consumption that is not compensated for by increased drilling power.

Air consumption in rock drills is much misunderstood. Assuming that the piston and valves are tight, in other words, where there is no leakage, air consumption is usually dependent upon the number of strokes delivered. It is assumed, of course, that a constant diameter and length of stroke are used and that the pressure is uniform. It is plain that if we are able to utilize air or steam at 100 lb. gage pressure for the full length of stroke when a percussive drill delivers its blow we are going to get the best results in drilling capacity; that is, we are going to get the hardest blow that is commensurate with the diameter, length of stroke, and pressure of the machine. If this blow is too hard, that is, if it breaks the steel, destroys the bit, or creates a condition where the drill is unmanageable on its mounting, then we have the alternative of reducing the size of the machine and in this way getting lighter weight, which is always desirable when it is consistent with the other conditions. We all know that the class of rock usually determines whether or not we are striking too hard a blow, but assuming that the class of rock is uniform, or that it is determined and understood, the engineer is obviously justified in providing a drill which will strike the hardest blow that the machine and the rock will stand without destructive consequences. We see, therefore, how important it *is to start with a machine which has a valve motion and ports*

so designed that the full power pressure will follow the piston the full stroke until the blow is delivered. Having this condition as light a machine should be used as will stand up to the work.

It naturally occurs to one that a quick-opening valve and a large port will bring about greater speed, but the question is asked, is not this condition wasteful in air consumption on the return or back stroke? It will be generally admitted that it pays to get the blow, but why should the same conditions that give us the blow obtain when the piston returns for another stroke? There are two reasons why this is advantageous. One is, that the pull-back on a piston type of drill is sometimes of as great importance in the long run as the blow. A weak pull-back reduces the speed of the machine, causing it to come back more slowly than it went forward, and it has the further disadvantage that holes that are not straight, or which are out of round, and where seams and other irregularities are encountered, will act to retard the steel during its reciprocations. This considerably reduces the efficiency of the machine, not only because it cuts down the number of blows delivered, but because it weakens the strength of blow. The steel is held back in its effort to reach the full stroke and a labored blow, with sometimes a shorter stroke, is the result. Now it is quite true that in good, clean, hard rock, without seams, and where holes are drilled to reasonable depths, it might pay to save air on the return stroke. As a matter of fact, this is always done in a piston drill because the diameter of the rod must be subtracted from the piston area. The percussive piston type of drill is naturally a compounded machine which hits a harder blow forward than backward, because it has the full piston area at one end and a reduced area at the other. It is not a difficult matter to regulate this to any degree desired by increasing or decreasing the size of the piston rod or by increasing or decreasing the valve and port areas on one end of the stroke and not on the other. But every attempt to compound a piston type of drill by putting a pressure in front of the piston is a mistake. Just in proportion as a pressure is introduced in the front end it would cushion or restrict the force of blow, and in doing this, as has been previously pointed out, we make it necessary to increase the weight of the machine in order to get the effective maximum blow. It is, therefore, a very dangerous expedient in the design of piston drills to attempt to compound the stroke. Reduced air consumption is easily effected at the sacrifice of efficiency. Air at 100 lb. is delivered to a percussive drill at a cost that varies from 40 cts. to \$2 per day. To save 25% of this is all that *compounding could reasonably be expected to accomplish, and*

this at the maximum is only 50 cts. a day. Experienced engineers will have no difficulty in seeing that there are many ways underground by which this and larger amounts may be lost through a machine which must inevitably be weakened in certain other directions in order to effect a small saving in air economy. Under most conditions of service it pays to conserve labor and upkeep expenses, giving first consideration to those things which cost most. A small reduction in drilling capacity, or a few idle hours, means an expense which will easily run in excess of any possible saving in air.

The hammer type of drill is a natural air saver, and it is in the design and construction of this type that air economies may be effected safely and without sacrifice. The hammer drill is essentially a machine for mines. It represents the evolution of the rock drill from the piece of steel struck by a hammer through the various stages of percussive machines back again to the hammer-driven blow upon the steel, the difference being only that the blow is a rapid power blow. A hammer drill is economical in air consumption because, in the first place, it reciprocates a light plunger which weighs only a few pounds, while with the piston drill not only must the heavy piston be thrown backward and forward at high speed, but it carries with it the steel and bit. In hammer drills the power is utilized, not in overcoming the inertia of a heavy body, but in compensating for that inertia through the high speed of a light body. A heavy mass moving slowly may give the same impact of blow as a light mass moving rapidly. The effective work done at the bottom of the hole is represented by the weight multiplied by the velocity. The same effect may be produced by subtracting from the weight and adding to the velocity, or *vice versa*. In a piston or percussive drill, velocity is limited, while in a hammer drill it is practically unlimited, and here is where the great possibilities of hammer drills have come in.

We must always bear in mind in comparing piston and hammer drills that the piston drill is handicapped by the load of the piston and steel, which has a certain inertia difficult to overcome in our efforts to reach high speed. The stroke is necessarily short, and as the hole gets deeper this handicap of weight is increased by longer steels, so that we are driven to high air pressures in order to get high speed. High air pressures naturally cost more money than low air pressures, and, as has been shown, if we attempt to save air by compounding we limit the capacity of the drill to force itself through difficult places. In holes at or near the horizontal there is always an added disadvantage in a percussive type of drill, due to the steel dragging in the hole. This will take place even in a clean, straight, round hole.

The steel sags, and in sagging, and during the process of rotation, there is a considerable friction loss within the hole. All this leads us to high pressures, which is only another expression for greater power. It is safe to say that the piston type of drill has reached its limit when we consider capacity as a limitation when rating efficiency. In down-hole service, especially for deep holes and in soft rocks, piston drills will always be useful. The pumping action of the bit serves to agitate the material at the bottom, especially when mixed with water, and in this way the hole is kept more or less clean under the bit.

The study of rock-drill economics has led the mechanical engineer into the hammer-drill field as one which offered the greater possibilities. The problem was to do more work and with a lighter machine. The next consideration was to accomplish this with a reduced labor and power cost. All of these conditions have been met and extraordinary results have been obtained which have materially reduced the cost of excavating rock and ore. We have seen that the process has been one of return to primitive methods. In other words, we have done what is most natural, and that which conforms closest to the laws of Nature is invariably best. The natural way to drill rock is to strike a piece of steel with a hammer. The only reason why the miner does not continue to do things in this way is because he cannot strike a sufficient number of blows. Just in proportion as he uses a heavier hammer does he reduce the number of blows that he is able to maintain and with the lighter hammer he is brought to an absolute limit. It would seem that the first thought of the engineer would have been to follow the old miner by building a rock drill on the hammer type. He may have thought of this, but the problem proved to be a very difficult one. The first difficulty was to get material that would stand up against this rapid-fire system. Then came the question of rotation, which was not easy to accomplish with a machine of the hammer design. Of equal importance was the question of keeping the bottom of the hole clean, because the bit being practically stationary at the bottom, the cuttings from the hole would pack between the edges of the bit and the bottom of the hole and prevent further progress. Jets of steam, of air, and of water were used to discharge the cuttings. Steam has many disadvantages, air is expensive and it creates dust, while water is, in the first place, difficult to introduce into the bottom of the hole, its mixture with parts of the drill results in wear and tear, and to use much water is a disadvantage and an expense in underground work. Up-hole work offers less difficulties for hammer-drill service than any other. The cuttings drop by gravity out of the hole and the only disadvantage is dust. Horizontal hole work is that

which is most difficult, while with down-holes water thrown into the hole always serves a useful purpose. A mixture of air and water has solved most of the problems arising from the use of hammer drills in mines. This is known as the Leyner system. Air is always available and is readily conducted in the hole, using either live or exhaust air. Where this air is commingled with water it discharges the cuttings from the bottom of the hole without blowing them away in the form of dust, but by simply reducing them to a puddle condition with enough water only to create a moderate stream, which discharges the cuttings through the orifice of the hole. This keeps the bit cool, there is enough puff to the air to remove the chips, and a long experience under all conditions of service has demonstrated conclusively that a mixture of air and water is more effective in cleaning the hole than even a large stream of water alone. In fact, air is the ideal thing to use, and it would be used alone were it not for the dust, so that the present system introduces only enough water to lay the dust. In doing this we effect economies by using only a small amount of water mixed with air from the exhaust.

The pneumatic tool, especially the type known as the riveter, illustrates the mechanical principles involved in the hammer drill. It is likely that the perfection of the pneumatic tool led to the perfection of the hammer drill. A riveter combines an extraordinary amount of power. Its efficiency is very high because the hammer speed is high, and the machine is light and easily handled. Its use in steel and iron construction is now universal. Air consumption in a tool of this nature is low in proportion to the work it does, because the thing reciprocated by the air is so light that it is easy to get high speed without sacrificing power to overcome inertia. In other words, there is a closer relation between the air pressure and the speed of hammer, with the resultant effective blow.

A point not to be lost sight of is that the rapid reciprocation of a flying piston, as in a hammer drill, is very much more easily mounted or held by an abutment than where we have a reciprocating action of a heavy weight, as in the case of a piston drill. The reasons for this are obvious. High speed of a light hammer takes the place of slow speed of a heavy hammer. One is like the rapid reciprocations of a hand hammer, the other the ponderous swing of a sledge. So great an effect is obtained by this rapid, light blow that it has been found practicable to reduce the weight to a figure considerably under 100 lb. in a machine which in drilling capacity compares favorably with a piston drill of two or three times the weight. In this light machine, material alone has not enabled us to cut down the

TABLE OF PERCUSSIVE AIR AND STEAM DRILLS

Cylinder Diameter	Stroke	Feed	Depth of Hole Drilled Easily	Diameter of Hole	Weight of Machine Unmounted	Consumption of Air at 80 lb. Pressure	Holler Power	Net Price	Class of Work Best Suited to the Machine
in.	in.	in.	ft.	in.	lb.	cu. ft.	hp.	\$	
2 1/2	5	15	6	1/4-1	127	76	6	120	Plug and feather, plug holes, small shallow holes, light work.
2 1/2	5 1/2	20	7	1/4-2	155	86	8	170	Plug and feather, plug holes, small shallow holes, light work, trench work, small tunnels, narrow veins.
2 3/4	6 1/2	24	10	1/4-2 1/2	216	104	8	173	Trench work, medium light work.
3	6 3/4	24	14	1/4-3	273	114	8	196	Trenches, mining, tunnels, shafts.
3 1/4	6 3/4	24	16	1/4-3	300	127	10	215	Standard size for general work and hard mining work.
3 1/2	7 1/4	24	20	1/4-3	370	131	10 1/2	218	Large open quarries, big tunnels and railway cutting.
3 3/4	7 1/2	27	22	1/4-4	408	143	11	251	Heavy tunnelling, heavy railway work, etc.
4	8	33	28	3/8-5	535	164	15	360	Heavy quarry work in hard granite, etc.
4 1/4	8 1/2	36	30-40	3/8-6	950	190	15	475	Submarine work, deep hole drilling.
5	8	4-10	40	3/8-6	1100	207	18	550	Submarine work, deep hole drilling.
5 1/2	9	10-20	60	3/8-6	1250	...	25	650	Submarine work, deep hole drilling.
6 1/2	9	10-20	60	3/8-6	1425	...	25	715	Submarine work, deep hole drilling.

weight, but the light rapidly moving piston design, with the quick-opening valve, is of equal importance. It would surprise a drill runner of ten years ago to learn that hammer drills are used today in hard rock, putting in holes 10 and 15 ft. in depth without even mounting the drill, it being held in the hand of the operator. Of equal importance in tunnel driving is the fact that by the use of hammer drills the equivalent of heavy machines is placed in the headings mounted upon a light horizontal bar, this bar being easily handled by a few men, yet it affords abutment enough to resist the jar, because the jar has been reduced to a minimum. Heavy upright columns, carriages, and other forms of support were made necessary because of the ponderous pulsations of the piston drill. To be able to use a light bar, placed horizontally, is of the greatest importance in tunnel driving because it affords an opportunity to begin drilling quickly after a blast and before the muck has been cleared away from the bottom of the heading.

An effort has been made in the foregoing statements to analyze and give reasons for a condition in rock-drill service which is now in practical operation. A hammer drill is the modern progressive miner. It has practically done away with hand drilling and in doing this it has largely increased the field of service.

The Parts of a Percussive Drill (Fig. 14):

1. The Cylinder.
2. Front head of the cylinder and stuffing box through which the piston works.
3. Back head of the cylinder.
4. One of the two side-rods or "through-bolts" that hold the cylinder head in place.
5. Steam chest.
6. Spool Valve.
7. Tappet valve which is oscillated by the shoulders on the piston.
8. The piston. (Note the cylinder rings which make an air-tight fit.)
9. The chuck at the end of the piston rod for holding the shank of the drill steel.
10. The rifle bar for rotating the piston on each back stroke.
11. Key that aids in holding the shank of the drill steel.
12. The U-shaped chuck bolt with a nut at each end of the U.
13. Two pawls forced by two pawl springs to catch the teeth of the ratchet wheel.
14. The ratchet wheel which prevents the rifle bar (10) turning on the forward stroke of the piston, but allows it to turn on the back stroke.

- 15. The guide shell on which the cylinder is mounted.
- 16. The cup by which the guide shell is fastened to the tripod or column arm.
- 17. Feed nut fastened to the cylinder.
- 18. Feed screw for moving the cylinder along the guide shell.
- 19. Crank of feed screw.

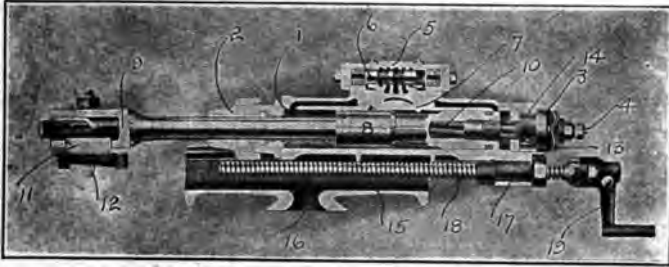

Fig. 14. "Sergeant" Rock Drill.

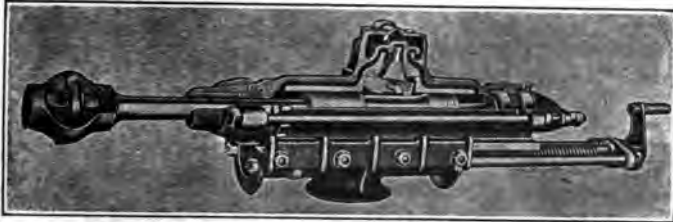

Fig. 15. Chicago Giant Tappet Type Rock Drill.



Fig. 16. Longitudinal and Cross Sections through the "Butterfly" Rock Drill, Showing Valve Mechanism and Reservoir Oiler.

In the percussion or reciprocating drill the drill rod or cutting tool is attached firmly to the piston. This piston reciprocates within the cylinder, its motion being controlled by the valve.

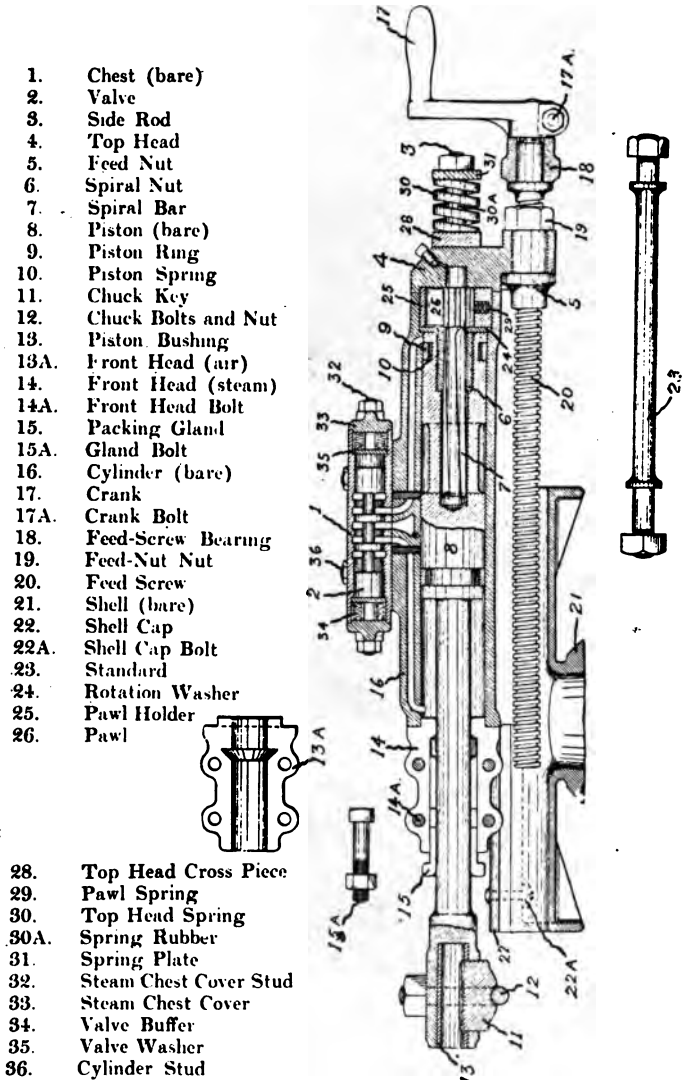

Fig. 17. Wood-Rock Drill.

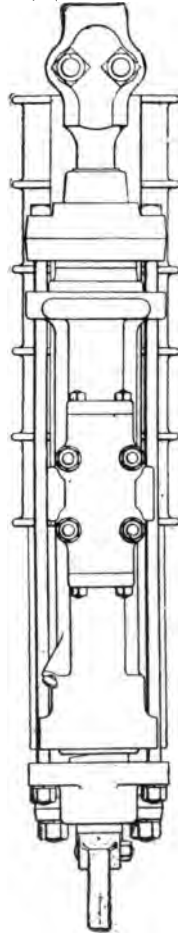
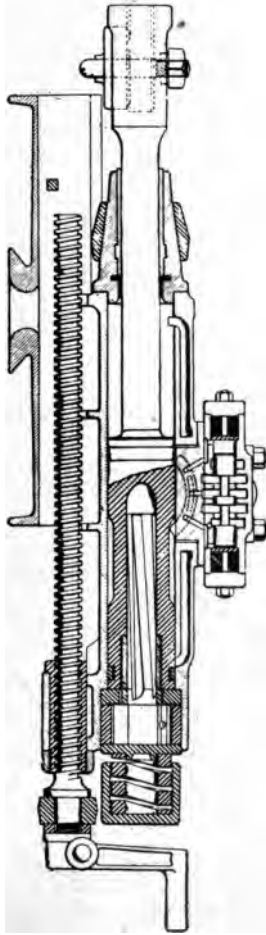
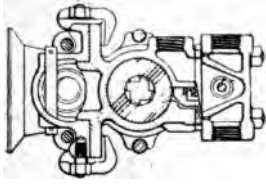

Fig. 18. Chicago Giant Rock Drill.

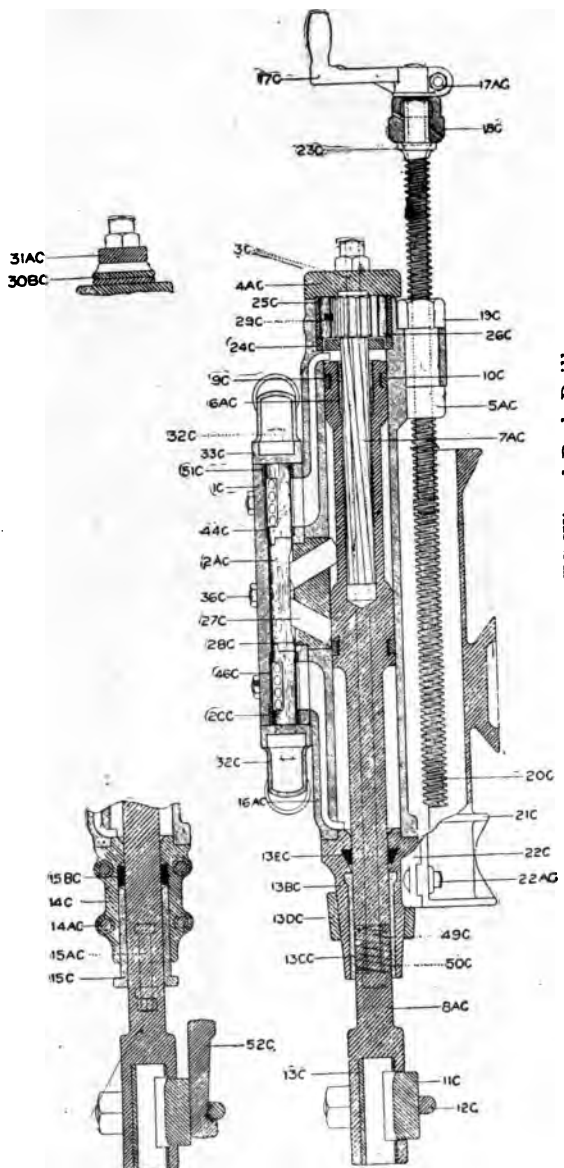

Fig. 19. Section of Type TC Wizard Rock Drill.

The rifle-bar, pawls and ratchet-wheels mechanically govern the partial rotation of the piston on each return stroke.

The drill is fed forward by hand, a crank at the end of a feed-screw being used for this purpose. A longer drill is inserted every 2 ft. in depth of hole, for 2 ft. is the limit of feed of the ordinary feed screw used. Automatic feed devices are not commonly used on drills of ordinary sizes, but only on very large drills for submarine work, or for drilling other very deep holes.

The Automatic Feed provided on Ingersoll-Sergeant Eclipse drills is designed for work with very large drills in deep holes in a uniform, free-cutting material. These machines have the regular hand feed and, in addition, a tappet entering the front end of the cylinder which is struck by the piston when the latter approaches the front head. This turns the ratchet nut at the rear of the cylinder.

The Sullivan FP-33 engine feed rock drill is designed to give a longer feed than usual. It is used for 20-ft. holes in open cuts where the surface of the rock is too rough to permit the use of an auto-traction drill (See pages 141, 147). This machine is similar to the Sullivan Hy-speed drill but the cylinder stands out from its shell so as to permit the chuck to revolve freely when drawn back in front of the gibs. The shell and screw-feed are of unusual length, and to the shell is attached a 2-cylinder reversing hoisting engine for raising and lowering steels.

Types of Valves. In some types of drills the piston acts as a valve to control the air or steam, but the valveless type of percussive rock drill is practically unknown.

Valves are of various kinds, the principal types being as follows:

- (1) *Tappet Valves*, or those in which the movements of the valves are mechanically controlled by the piston.
- (2) *Corliss Valves*, or those in which a Corliss valve is either controlled mechanically or by the air or steam.
- (3) *Air Valve*, or those in which the valve movements are controlled by the pressure of the air or steam.
- (4) *Auxiliary Valve*, or those in which a primary valve is controlled by the air or steam and the air or steam is controlled by valves mechanically operated by the piston.

Tappet Valves are particularly suited to operation by steam or moist compressed air as other types of valves are affected by moisture.

The blow of the drill is not entirely free but is somewhat cushioned by the air or steam. This fact, however, makes this type of drill an admirable one for use in rock where the bit

sticks, as the return stroke is very powerful. The wear on this type of drill is considerable. Drills of this type of American manufacture are given in Table VII.

Corliss Valves are in general unsuccessful due to the extremely rapid wear. The McKiernan-Terry Corliss-valve drill, shown in Table VIII, is suited to drilling soft rocks that form into heavy "sludge" or in hard "fitchering" or "sticky" ground.

Air Valve drills are very fast drillers in dry air, but are subject to rapid wear. The movements of the piston control those

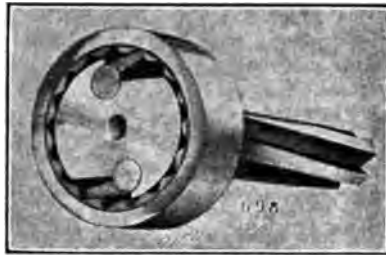

Fig. 20. Sergeant Slip rotation.



Fig. 21. Sullivan Rifle Bar and Ratchet.

of the valve by varying the air pressure on the valve surface. American drills of this type are given in Table IX.

Auxiliary Valve drills have a free blow and can be operated with a very short stroke thus rendering starting easy. In this type one valve, operated with positive action by the piston, controls the air acting on and actuating a second valve.

The Rotation Systems on percussive rock drills may be divided into "Pawl and Ratchet" rotation, "Slip" rotation, and "Modified Slip" rotation.

Size of Steam or Air Drills. The size of a steam or an air drill is denoted by the inner diameter of its air or steam cylinder;

thus a $3\frac{1}{4}$ in. air drill is one having a cylinder $3\frac{1}{4}$ in. in diameter.

The smallest size of percussive drills ($2\frac{1}{4}$ in.) is called a "baby drill," or a one-man drill — the latter name being given to the drill because it can be readily moved about and set up by one man. For narrow work in mines the baby drill is adapted. It is also used largely for drilling plug and feather holes, and might often be used profitably for shallow cuts and trenches. The sizes of percussive drills most commonly used for general contract

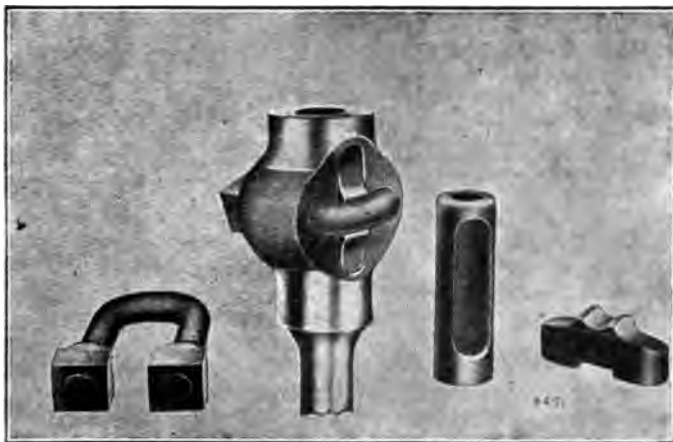

Fig. 22. The "Sergeant" 32 Drill Chuck.

work, tunneling and mining are the $3\frac{1}{8}$ -in. and the $3\frac{1}{4}$ -in. drills. Report of the year 1902 states that in 101 gold mines of the Transvaal, South Africa, 2,355 air drills were in use, and of this number 1,680, or 70% were $3\frac{1}{4}$ -in. drills. Where the holes are deep and the drilling hard, it is often found that the $3\frac{5}{8}$ -in. drill is the size to be chosen. Thus, in shaft sinking in syenite at the Treadwell Mine, Alaska, it has been found that the number of feet drilled with the $3\frac{5}{8}$ -in. drill is fully 30% greater than with the $3\frac{1}{4}$ -in. drill. On the other hand in soft rock such as shale the heavy drill drives the bit so far into the rock as to cause it to stick, and the lighter machine is therefore more economical. Other conditions being equal, the force of the blow struck will vary approximately as the square of the diameter of the cylinder. In a similar way, the force of the blow depends directly on the length of the cylinder.

Sizes of Percussive Drills. Tables VII to IX give the details

of percussive rock drills. The numbers in the first column indicate the following:

No.	Item	Unit
1	Manufacturer
2	Kind of drill
3	Model
4	Diameter of cylinder	Inches
5	Length of stroke	Inches
6	Length of drill over all	Inches
7	Diameter of steel used	Inches
8	Size of shank	Inches
9	Length of feed	Inches
10	Depth of vertical hole drilled easily	Feet
11	Number of bits to drill holes above depths	Number
12	Diameter of holes drilled, at bottom	Inches
13	Diameter of supply inlet	Inches
14	Size of boiler for ample steam supply, 1 drill	H. P.
15	Diameter of steam pipe to carry steam 100 to 200 ft.	Inches
16	Weight of drill unmounted with wrenches and fittings unboxed	Pounds
17	Weight of drill, tripod, weights and fittings	Pounds
18	Price (net) of drill unmounted, with wrenches and fittings	Dollars
19	Price (net) of drill complete, including weights, tripod, throttle, oiler, and wrenches	Dollars

TABLE VII. TAPPET VALVE DRILLS

	Hardsocg Wonder Drill Company			W
	Hardsocg Wonder (Reciprocating)			
	S	U	V	
3
4 2½ 2% 3% 3%
5 5% 6% 6% 6%
6
7 % 1 1% 1%
8
9 20 26 26 26
10 8 14 18 20
11 6 7 9 10
12 1% 1½ 1% 1%
13
14 6 8 10 10
15
16 145 215 275 285
17
18 200 220 275 300
19 250 275 340 365

TABLE VII. TAPPET VALVE DRILLS—Continued

Item	Chicago Giant							
3								
4	2 1/4			3 1/4	8 1/4			8 1/4
5	5 1/4			6 3/4	6 3/4			7 1/4
6	4 1/4			47	47			63
7	7 1/4			1 1/4-1 1/4	1 1/4-1 1/4			1 1/4
8	7/8 X 5			1 1/4 X 6	1 1/4 X 6			1 1/4 X 6 1/4
9	20			26	26			32
10	9			18	20			22
11	6			9	10			10
12	1 1/2-2 1/4			1 1/4-2 1/4	1 1/4-2 1/4			2 1/4-3 1/4
13	6			1	1			1 1/4
14	8			10	10			1 1/4
15	1			1 1/4	1 1/4			1 1/4
16	150			265	273			307
17	585			945	955			1305
18	203			275	275			380
19	238			332	350			450

Wickes Bros.

"Murphy Little Champion"

Item	Wickes Bros.							
3								
4	2 1/4			3	3 1/4			3 1/4
5	2 1/2			0 1/2	0 1/2			7 1/4
6	5 1/2			1 1/4-1 1/4	1 1/4-1 1/4			1 1/4-1 1/4
7	3/4-7/8			1 1/4 X 5 1/2	1 1/4 X 5 1/2			1 1/4 X 6
8	3/4 X 4			24	24			24
9	15			10	10			20
10	5			12	14			20
11	4			6	7			10
12	7/8-2			1 1/4-3	1 1/4-3			1 1/4-3 1/4
13	3/4			1	1			1
14	1			1 1/4	1 1/4			1 1/4
15	1			245	270			340
16	125			910	935			1260
17	455			275	285			325
18	200			300	300			360
19	230			325	335			410

TABLE VIII. CORLISS VALVE DRILLS

Item	Manufacturer	T O 2%	T O 3	Corliss Valve Type "T. C."	T O 3%
1. Manufacturer	Mckiernan-Terry Co.				
2. Catalogue name	Corliss Valve Type "T. C."				
3. Number		2%	3	3%	3%
4. Diam. of cylinder, in.		6%	6%	6%	8%
5. Stroke, in.		1	1 1/4-1 1/4	1 1/4-1 1/4	1 1/4-1 1/4
6. Length overall, in.		24	24	24	24
7. Diam. of steel, in.		12	17	16	24
8. Length of feed, ft.		1	1 1/2	1 1/2	1 1/2
9. Depth of hole, ft.		1	1 1/2	1 1/2	1 1/2
10. No. changes of steel		1	1 1/2	1 1/2	1 1/2
11. Bottom diam. of hole, in.		1 1/2-2	1 1/2-2 1/4	1 1/2-2 1/4	1 1/2-3
12. Diam. of supply inlet, in.		1	1	1	1
13. Boiler hp. required		8	8	10	10
14. Diam. supply pipe, 100 to 200 ft.		1	1	1	1 1/4
15. Wt. unmounted		230	279	310	480
16. Weight mounted, tripod, etc.		250	275	300	320
17. Price unmounted		310	347	372	404
18. Price complete, tripod, etc.					
19. Price complete, tripod, etc.					

TABLE IX. AIR VALVE DRILLS

Item	Ingersoll-Rand Company.	E3	FA	F3	G2	GAI	H2	HAI
1. Manufacturer	Eclipse.							
2. Catalogue name	B2							
3. Number	2 1/2	3 1/16	3 1/2	3 1/2	4 1/4	4 1/4	5	6
4. Diam. of cylinder, in.	5	6 1/2	8	8	7 1/4	8	7 1/4	6 1/4
5. Stroke, in.	4 1/2	4 1/2	6 1/2	6 1/2	6 1/2	6 1/2	6 1/2	6 1/2
6. Length overall, in.	1 1/4-1 1/2	1 1/4-1 1/2	1 1/4-1 1/2	1 1/4-1 1/2	1 1/4-1 1/2	1 1/4-1 1/2	1 1/4-1 1/2	1 1/4-1 1/2
7. Diam. of steel, in.	4 3/4 x 7/8	5 1/2 x 1	5 1/2 x 1 1/4	5 1/2 x 1 1/4	5 1/2 x 1 1/2	5 1/2 x 1 1/2	5 1/2 x 1 1/2	5 1/2 x 1 1/2
8. Length of feed, ft.	2 1/2	2 1/2	2 1/2	2 1/2	2 1/2	2 1/2	2 1/2	2 1/2
9. Depth of hole, ft.	1 1/2	1 1/2	1 1/2	1 1/2	1 1/2	1 1/2	1 1/2	1 1/2
10. No. changes of steel	1	1	1	1	1	1	1	1
11. Bottom diam. of hole, in.	1 1/2-2 1/4	1 1/2-2 1/4	1 1/2-2 1/4	1 1/2-2 1/4	1 1/2-2 1/4	1 1/2-2 1/4	1 1/2-2 1/4	1 1/2-2 1/4
12. Diam. of supply inlet, in.	1	1	1	1	1	1	1	1
13. Boiler hp. required	8	8	10	10	11	11	13	13
14. Diam. supply pipe, 100 to 200 ft.	1	1	1	1	1	1	1	1
15. Wt. unmounted	250	295	420	400	675	740	750	815
16. Weight mounted, tripod, etc.	260	965	1105	1080	1710	1775	1770	1860
17. Price unmounted	225	275	320	320	365	365	415	415
18. Price complete, tripod, etc.	275	325	375	375	430	430	480	480
19. Price complete, tripod, etc.								

* These numbers refer to items listed as in Table VIII.

TABLE IX. AIR VALVE DRILLS — Continued .

Item.	McKiernan-Terry Drill Company Spool Valve Type "B"				S3 1/4	S3 3/4	S4 1/4
	S2 1/2	S2 3/4	S3	S3 1/2			
1							
2	S2 1/2	S2 3/4	S3	S3 1/2	8 1/2	10	12
3	2 1/4	2 3/4	3	3 1/2	7 1/2	9	11
4	4 1/4	5 1/4	6 1/2	7 1/2	7 1/2	8 1/2	9 1/2
5	5 1/2	6 1/2	7 1/2	8 1/2	8 1/2	9 1/2	10 1/2
6	6 1/2	7 1/2	8 1/2	9 1/2	9 1/2	10 1/2	11 1/2
7	7 1/2	8 1/2	9 1/2	10 1/2	10 1/2	11 1/2	12 1/2
8	8 1/2	9 1/2	10 1/2	11 1/2	11 1/2	12 1/2	13 1/2
9	9 1/2	10 1/2	11 1/2	12 1/2	12 1/2	13 1/2	14 1/2
10	10 1/2	11 1/2	12 1/2	13 1/2	13 1/2	14 1/2	15 1/2
11	11 1/2	12 1/2	13 1/2	14 1/2	14 1/2	15 1/2	16 1/2
12	12 1/2	13 1/2	14 1/2	15 1/2	15 1/2	16 1/2	17 1/2
13	13 1/2	14 1/2	15 1/2	16 1/2	16 1/2	17 1/2	18 1/2
14	14 1/2	15 1/2	16 1/2	17 1/2	17 1/2	18 1/2	19 1/2
15	15 1/2	16 1/2	17 1/2	18 1/2	18 1/2	19 1/2	20 1/2
16	16 1/2	17 1/2	18 1/2	19 1/2	19 1/2	20 1/2	21 1/2
17	17 1/2	18 1/2	19 1/2	20 1/2	20 1/2	21 1/2	22 1/2
18	18 1/2	19 1/2	20 1/2	21 1/2	21 1/2	22 1/2	23 1/2
19	19 1/2	20 1/2	21 1/2	22 1/2	22 1/2	23 1/2	24 1/2
20	20 1/2	21 1/2	22 1/2	23 1/2	23 1/2	24 1/2	25 1/2

TABLE IX. AIR VALVE DRILLS — Continued

Item.	Sluggers	Ingersoll-Rand Company.	H9	New Ingersolls	K64a
1
2	13	33	5 1/2	5 1/2	6 1/2
3	3 1/2	3 1/2	8	8	0
4	6 1/2	6 1/2	60	81	00
5	6 1/2	6 1/2	1-3/4	2-2 1/2	2-2 1/2
6	48 1/2	48 1/2	1-3/4	2x8	2x8
7	48 1/2	48 1/2	1 1/2 x 6 1/2	1 1/2 x 7	2x8
8	1 1/2	1 1/2	80	40	60
9	1 1/2	1 1/2	20	18	8-6
10	16	14	8	8-6	1 1/2
11	8	7	9	1 1/2	26
12	1 1/2	1 1/2	1 1/2	18	..
13	1 1/2	1 1/2	..	1 1/2	..
14
15
16	340	258	980	1100	1250
17	939	897	1900
18	300	275	700	550	600
19	350	325	765

a. Submarine drills.

TABLE IX. AIR VALVE DRILLS — Continued

Item.	Sullivan Machinery Company Differential Valve Drill											
	UA*	US*	UB*	FF12*	UC11	UCt	UCD*	UE2t	UF2UF3t	UH2	UK*	UL*
1											
2											
3	2 1/4	2 1/2	2 3/4	2 3/4	3	3 1/4	3 1/4	3 1/4	3 1/4	4 1/2	5
4	5 3/4	5	5 3/4	6 1/4	6 1/2	6 1/2	6 1/2	6 1/2	7 1/4	8	8
5	5 3/4 - 1	5 7/8 - 1	1	1	1	1 1/4 - 1 1/4	1 1/4 - 1 1/4	1 1/4 - 1 1/4	1 1/4 - 1 1/4	1 1/2 - 1 1/2	1 1/2 - 1 1/2
7	15 3/4 - 20	20	22	24	24	24	24	24	24	28	30
8	5	6	6	8	8	12	14	16	20	28	32
10	5	6	6	8	8	12	14	16	20	28	32
11	3 - 4	4	5	5	5	6	7	8	10	10	13
12	3 7/8 - 2	1 - 2 1/4	1 1/4 - 2 1/2	1 1/4 - 2 1/2	1 1/4 - 2 1/2	1 1/4 - 3	1 1/4 - 3	1 1/4 - 3	1 1/4 - 4	2 - 5	8 - 6
13	6 3/4	8	8	8	8	8	10	10	12	15	15
14	6 3/4	8	8	8	8	8	10	10	12	15	15
15	1	1	1	1	1	1 1/4	1 1/4	1 1/4	1 1/4	1 1/2	1 1/2
16	145	165	160	240	265	260	260	295	365	560	900

* Differential valve only. t Differential or tappet valve.

TABLE IX. AIR VALVE DRILLS — Continued

Item.	Sullivan Machinery Company				Submarine	
	"Liteweight"		FP-12	FP-12	FS-14	FV-14
1						
2						
3						
4						
5						
6						
7						
8						
9						
10						
11						
12						
13						
14						
15						
16						
17						
18						
19						
20						
21						
22						
23						
24						
25						
26						
27						
28						
29						
30						
31						
32						
33						
34						
35						
36						
37						
38						
39						
40						
41						
42						
43						
44						
45						
46						
47						
48						
49						
50						
51						
52						
53						
54						
55						
56						
57						
58						
59						
60						
61						
62						
63						
64						
65						
66						
67						
68						
69						
70						
71						
72						
73						
74						
75						
76						
77						
78						
79						
80						
81						
82						
83						
84						
85						
86						
87						
88						
89						
90						
91						
92						
93						
94						
95						
96						
97						
98						
99						
100						
101						
102						
103						
104						
105						
106						
107						
108						
109						
110						
111						
112						
113						
114						
115						
116						
117						
118						
119						
120						
121						
122						
123						
124						
125						

Wood Drill Works
Wood Drill

1						
2						
3						
4						
5						
6						
7						
8						
9						
10						
11						
12						
13						
14						
15						
16						
17						
18						
19						
20						
21						
22						
23						
24						
25						
26						
27						
28						
29						
30						
31						
32						
33						
34						
35						
36						
37						
38						
39						
40						
41						
42						
43						
44						
45						
46						
47						
48						
49						
50						
51						
52						
53						
54						
55						
56						
57						
58						
59						
60						
61						
62						
63						
64						
65						
66						
67						
68						
69						
70						
71						
72						
73						
74						
75						
76						
77						
78						
79						
80						
81						
82						
83						
84						
85						
86						
87						
88						
89						
90						
91						
92						
93						
94						
95						
96						
97						
98						
99						
100						
101						
102						
103						
104						
105						
106						
107						
108						
109						
110						
111						
112						
113						
114						
115						
116						
117						
118						
119						
120						
121						
122						
123						
124						
125						



Fig. 23. "Butterfly" Rock Drill.

Drill Mounting. Drills are either held in the hand or mounted on a tripod, a column, quarry bar or a special drill carriage or frame.

The Tripod (Fig. 23) is built with a universal joint to permit the legs and drill to stand at any angle; the legs are telescopic. On these legs are hung detachable weights for steadying the ma-



Fig. 24. Chicago Giant Rock Drill on Column Mounting — Tunnel Work.

chine. These weights weigh from 150 to 400 lb. per set of three. The Lewis-type tripod has a front bar for giving the drill a lateral movement of 6 to 9 inches and is particularly suited for work where the holes are close together.

The Tunnel Column (Fig. 24) usually holds two machines and is used in large drifts and tunnels. The drill is saddled to a cross arm which in turn is clamped to the column. The weight ranges from 200 to 550 lb.

The Stretcher Bar is a single screw column capable of holding



Fig. 25. Rhode Island granite quarry showing the Sullivan "Hy-Speed" Drill and Quarry Bar.

one machine and is used in small drifts. It is generally 3 to 5 in. in diameter and about 6 to 8 ft. long with a screw capable of increasing the length about 10 in. The weight is from 100 to 450 lb.

The Quarry Bar (Fig. 25) consists of a horizontal bar supported at each end by legs. The bar is 3 to 6 in. in diameter and 8 to 12 ft. long, with a weight complete of from 500 to 1500 lb.

The Gadder (Fig. 26) mounting is distinctly a quarry device and is used where a number of parallel holes are to be drilled in a plane at any angle from horizontal to vertical. Used in connection with the channeler, it is applied in "lofting" or drilling the horizontal under-cutting holes in material which has been channeled. Used in "plug-and-feather" work it breaks up the large blocks cut free by channelers. The machine consists of a heavy cast iron truck mounted on wheels, to which a standard is hinged, adjustable by a screw and a hand-wheel from nearly horizontal to vertical. A sliding saddle carries a rock drill and shell, being raised or lowered on the standard by means of a chain, sheave and drum.

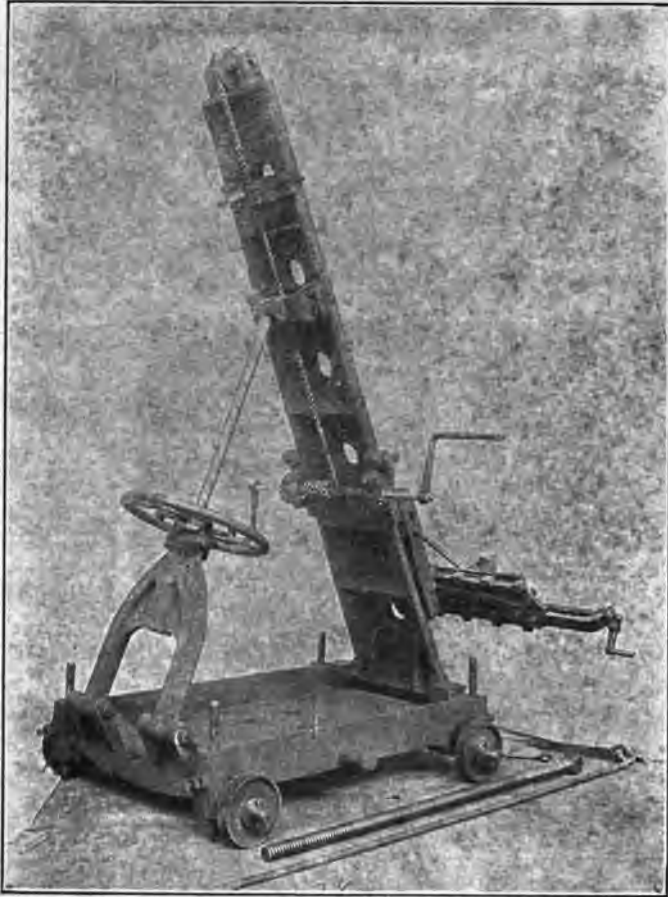

Fig. 26. Ingersoll-Sergeant Gadder.

The net price of a Gadder frame is from \$400 to \$450, and the weight ranges from 2500 to 3500 lb.

Handling a Percussion Drill on a Tripod. A drill mounted upon a tripod is the combination commonly used for surface drilling, and even underground on the benches of railway tunnels and often in stopping ores. I shall discuss the handling of the

tripod drill somewhat in detail, for every manager of drilling forces should know such of the details as will be set forth, beside many others which the recital of these details may stimulate him to learn for himself by observation.

The order of tripod drilling operations is as follows:

1. Have laborers clean away all earth and loose rock over the sites of proposed drill holes; for earth would clog the drill and would not give a stable support for the tripod. If the surface of the rock to be drilled is loose and shelly, have the laborers clean it away down to solid rock, for a hole cannot be started on loose, shelly rock. I have often seen the expensive drill crew delayed 15 or 20 min. while one of the crew was occupied cleaning away shelly rock. A laborer at 15 ct. an hour will do this work as well as a drill crew at 50 ct. an hour.

2. Set the tripod over the site of the proposed hole, giving the legs a good spread to secure stability. At best there is considerable vibration when the drill is at work. A small "cat hole" is dug in the rock with a pick or a hand drill for the point of each tripod leg to set in. If in a muddy place or soft rock where the leg might not set firm, screw a common washer on a block of wood and let the leg rest on it.

3. Having "spotted" the leg points, the legs are adjusted until the saddle is about horizontal. The set screws are then tightened and the tripod leg weights put on.

4. If the machine is not already in its saddle, place it there and fasten the saddle to the cup.

5. See that the exhaust pipe is screwed in tight with a wrench, for if it jars loose it may wear or strip the threads, and, when next screwed up, may partially choke the exhaust passage. The steam chest plugs must be screwed tight.

6. Unloosen the nut that clamps the tripod saddle and point the drill in the line of the proposed hole.

7. The "starter," or first drill, is inserted in the "chuck" (Fig. 22) after wiping the shank of the drill clean; and the nuts of the chuck bolts are set by first screwing one and then the other until they are perfectly tight. Be sure that the shank of the drill is in as far as it will go before tightening the U-bolt. The starter should have a sharp bit welded to a full sized and perfectly straight drill rod. Beware of a slender drill rod with a nub bit wherever difficulty is expected in starting the hole. If the shank of the drill steel is covered with dirt or mud, wipe it off before putting it in the chuck. The steel should be fastened tight in the chuck or it will abrade the bushing and cause the drill to run off center.

8. The piston is drawn back until it strikes the cylinder head.

The bit is fed forward until the bit strikes the rock, and the point where it strikes is spotted.

9. The piston is shoved into the cylinder, and the bit is raised by the feed-screw.

10. The rock where the bit will strike is faced square for an area of $\frac{1}{2}$ in. or more larger than the bit; for if the drill strikes a glancing blow it may bend the shank, and due to the vibration of the machine, it will vary $\frac{1}{2}$ in. in its alignment.

11. The piston is moved in until it is about the center of the cylinder, and a little oil is let into the cylinder if the machine has not been used in some time, and is operated by air.

12. Turn the air or steam through the hose before coupling it to the drill, in order to blow out any dust or chips; turn off the air and wipe the threads of the coupling clean.

13. Turn off the throttle valve of the machine, then couple on the hose.

14. Let the drill runner test all the nuts with his wrench; and in tightening nuts bear down on the wrench instead of pulling up, as pulling up may shift the machine.

15. Run the bit down to within 1 in. of the rock, for in that position the drill automatically gives a short stroke, and a short stroke is always desirable in starting a hole.

16. Open and then close the throttle if steam is the power used, and work the piston back and forth by hand two or three times, so as to heat everything up evenly and prevent breaking of a part. Then tighten up the side rods which have been left loose to avoid breaking them by the heat expansion. Tighten them evenly and no more than is necessary to secure a tight steam joint.

17. Open the throttle valve part way so that the drill will strike a light blow until a depth of hole has been reached that is greater than the full stroke of the drill, that is, until the bit no longer lifts above the surface of the rock. A little slowness in starting is time saved, because the danger of breaking the drill is avoided and a true round hole is secured.

18. The helper "tends chuck" by pouring in water, using a can filled from a bucket nearby. Too much water will prevent the sludge from dashing up well, and will cause clogging. Too little water also results in accumulation of sludge at the bottom of the hole.

19. When the drill has worked up to its full stroke, the feed-crank is turned slowly so as to keep the bit in position to strike a full blow. If the feed is too slow the piston strikes the cylinder head with a metallic sound that is unmistakable; in which case give the feed-crank a few rapid turns to prevent damage. If the feed is too fast the stroke is automatically short-

ened, and the rate of penetration of the drill is materially decreased.

20. When steam is used instead of air, more or less steam will condense in the feed pipe during the time that a drill is being moved from hole to hole. Therefore do not let oil into the cylinder until the drill has been running some time (long enough for the water to have all been blown out). The piston must be kept perfectly lubricated to avoid rapid wear.

21. When the feed-screw has reached its limit (the feed is 2 ft. in ordinary sizes), the air is turned off; the drill is raised as far as the feed screw will run, and taken out of the chuck. The hole is cleaned with a "gun" or sand pump. If the hole is shallow a stick broomed at the end may be used to remove the sludge at the bottom of the hole.

These twenty-one rules of ordinary procedure may now be supplemented by a few rules for emergencies and the care of drills.

1. The repeated sticking of a bit in a hole is most exasperating to the drill runner, and the usual remedy is to strike the drill shank viciously with a sledge until the bit comes loose. It is needless to add that this remedy often kills the patient, like other heroic treatments. A moderate blow on the drill shank, near the hole, is a reasonable and often successful means of loosening a stuck bit. A blow should never be hard, and never so high up as to strike the "chuck," for a bent piston or a broken "chuck," is likely to result when hard or high blows are struck.

2. When a bit sticks, nine times out of ten the cause is a crooked hole; and the remedy is a movement of the machine bodily to counteract the tendency of the hole to become crooked. If the drill sticks repeatedly, loosen up the clamp that the shell sits in and determine whether the drill is on line with the hole. If it is not, slacken off on one of the tripod legs so as to throw the drill rod against the side of the hole in the direction the hole is crooking. A lazy driller will hammer his drill; a good driller will reline it.

3. If the bit strikes an inclined layer of rock, and particularly if that layer is harder than the rock above, the bit will glance off toward the "down hill" side and probably stick. The best remedy that I have found in this case is to drop a number of fragments of cast iron, or other chips of iron, into the hole. These fragments of iron are forced into the soft rock on the lower side, and practically produce a level surface for the bit to strike upon. Old $\frac{3}{4}$ -in., or larger, gas pipe may be cut up into bits with a cold-chisel for this purpose. If the inclined layer of hard rock is not very hard, small quartz pebbles, or the like, will serve instead of iron. If iron is used in the hole, the plug should be marked as a caution to the blaster, who should

be careful in loading the hole and should not attempt to ram the charge past an obstruction in such holes because of the danger of a premature explosion caused by the iron.

4. In any case, when a drill starts to stick, shorten the stroke of the drill by feeding down the feed screw, so that the air or steam may get between the piston and the front head; and work for a time with short strokes.

5. Often the cause of sticking is in the bit itself, which may have a broken ear, or the drill rod or shank may not be exactly central with the center of the bit, due to poor blacksmith work. In shale a bit may stick if the cutting edge is not properly shaped. Upon changing the shape and using a bit with sharp cutting edges and a sand pump, bits in a Southern Illinois quarry worked much better than before.

6. If the rock produces a clay sludge that adheres to the bit and causes sticking, a pipe may be put down in the hole after removing the drill, and a steam or air jet blown through it. This will effectually clean out the sludge when other means fail. Ordinarily, however, all that is necessary is to crank the drill back, pour in a cup of water, turn on about a quarter of the head of air and churn the stiff mud as the machine is cranked up.

7. The softer the rock the more rapidly does the sludge accumulate. To remove the sludge as fast as it forms, a jet of water is most effective. A small pipe is kept in the hole alongside the drill rod, and water is continuously forced through the pipe, either by gravity or by steam or air pressure. In some rocks the increased number of feet drilled per day after a water jet is installed is astounding—amounting often to a 100% increase.

8. An effective method of keeping the drill from sticking is to keep churning up and down in the hole with a hickory wand the size of a barrel hoop. These wooden sticks keep the sludge stirred up and away from the bottom of the bit, and will double the cutting speed in soft shales. The labor involved in using these wands is considerable, but if they are not used vigorously they are useless. In winter weather when the freezing of water from jets causes trouble, these wands are particularly useful.

9. When moving the drill from place to place the piston should be kept inside the cylinder, for otherwise it may be bent if the drill is allowed to fall.

10. A good mineral cylinder oil should be used in the air chest, and from there it passes into the cylinder. Feed in a small amount at frequent intervals, and on a new drill use an excess of oil for the first few days, because the moving parts of a new

machine fit tight and hold very little oil at one time. Ordinarily use about 2 pints of oil per drill per shift. Do not oil a steam drill that has been idle for some time until the water is all out of it.

11. In cold weather, when steam is used, the stuffing box should be unscrewed to let the water out of the cylinder by inclining the drill on its side so as to drain the steam chest and back head.

12. When the machine is not in use it is important to keep the valve and piston well oiled, otherwise rust will rapidly eat away the machined surfaces.

13. Keep on hand a supply of U-bolts and nuts, and have the blacksmith learn to make them, as their life is short at best. A bolt that permits a nut to work loose should be discarded at once, for it is the poorest kind of economy to continue using it. Square nuts are preferable to hexagonal nuts, as they require less time to tighten up and are less likely to slip from the wrench. A supply of pawls and pawl springs should also be kept in stock, for while a drill will work with one pawl (after removing the broken one), it will not work economically. Much of the poor work done by drills may be attributed to working with one pawl.

14. In hard rock it often happens that a bit dulls so rapidly that its ears wear off more than is usual; in which case the hole becomes smaller than usual, and, as a consequence, the next new bit will stick on the sides of the hole before reaching the bottom. In this case insert the shank into the chuck, crank up close, turn on the air without tightening the nuts of the U-bolt of the chuck. This will drive the bit straight to the bottom of the hole. Pull it up, turn the bit, and in like manner drive the bit down in a new position; repeat this operation once more and the hole will probably be reamed sufficiently to proceed with the regular drilling.

15. When a drill is choked in the hole and cannot be loosened by hammering, it is often possible to loosen it by running with a loose chuck as just described, and turning the drill with the hands during the back stroke of the piston.

16. When laying up rock drills cover the bright surfaces with a mixture of paraffine and vaseline, heated and applied with a brush. This mixture is readily rubbed off.

Use of the Column or Bar. In the early days of tunneling machine drills were mounted on cars running on tracks, and this is still the practice in Europe; but in America the drill is usually mounted on column (Fig. 24) or bar made of 3 to 5½-in. pipe provided with one or two screw jacks at one end. In tunneling the column is usually set upright with blocks of wood between

its ends and the rock, although in narrow headings it is often found preferable to set the bar horizontally just as is done of necessity in shaft sinking. The machine is mounted on an arm projecting from the column. The advantage of the column method over the car method of mounting drills is that without waiting for the blasted rock to be entirely cleaned away, the drillers can set up and get to work. A column is preferable to a tripod where it can be used, for it gives a firmer support and there is in consequence less liability of the hole running crooked. Moreover in a stope where the men stand on loose rock it is very difficult to get a solid footing for each of the three tripod legs without laying a substantial flooring of some kind to work upon.

In mining work it is advisable to have an assortment of bars; for one driller may require a bar 3 ft. long for a horizontal set up, whereas another may find a 9 ft. bar none too long for an upright set up.

1. Blocks of tough wood, reasonably free from knots, are placed between the ends of the bar and the rock. Sawed wedges about 1 ft. long and of varying thickness at the butt are preferable; but blocks that are flat on the side next to the rock and rounded on the side next to the bar may be used. Most of the blocking should be placed at the jacking end of the bar if possible; a 2-in. piece properly wedged up will serve for the other end, which, in a vertical set up, is the upper end of the bar.

2. The shoe or shoes should fit squarely on the blocking; and to this end the bar may be deflected if necessary.

3. Having placed the blocking, the jack screws are jacked up until the column is solid, after which the safety clamp is put on and its screws set up. If the set up is on the muck filling of a stope, jack up a little at a time, as the muck settles under the vibration of drilling, and thus avoid splitting the blocking by trying to jack up all at once.

4. The column arm is next put on the column, but its nuts are left a trifle loose, so that the arm may be swung about.

5. The saddle clamp is slipped over the arm and bolted with the clamp side up; and the machine is set in the saddle and swung into line for drilling.

6. To swing the machine so as to drill another hole, the safety clamp is not released until the drill has been pointed in the direction of the new hole; then it is released and clamped in the new position.

7. To dismount the machine, remove the drill steel, release the safety clamp and slacken the arm bolts, so that the machine may be lowered gently by the driller as far as it will go, and the machine removed from its saddle.

8. In starting a hole on a face of hard, slanting rock lower the

machine a little on the bar and drill a few inches, then raise the machine and catch the edge of the hole thus started.

Air Hammer Drills. In the "air hammer drill," or "hammer drill" as it is commonly called, the end of the drill steel is either struck directly with a hammer action by an air-driven piston operating in a cylinder, or by an anvil block or striking pin which is interposed between the piston and steel. The drill steel is not fastened to the piston as in the percussive drill. Hammer drills, therefore, act as does a drill bit operated by a hand hammer, whereas the percussive or reciprocating drill acts like a hand churn drill. The steel may be rotated automatically, mechanically, or by hand. In some types the entire machine rotates.

A hammer drill may be held in the hand, or mounted on a cradle as in a percussive drill and fed forward by a screw, or mounted and fed forward by an air-feed arrangement. In some machines the air-feed and hand-held arrangements are interchangeable, as in the McKiernan-Terry "A-346 Rotating Hammer," the Ingersoll-Rand "Little Jap," and the Whitcomb hammer drill. Hammer drills that are not mounted but that are held in the hand, are commonly known as hand-hammer drills, "pluggers" or "plug drills." This type of drill, while used in tunneling and mining for trimming and sinking, is also finding favor for trench work, in quarries, etc. The only American hammer drills that are mounted and used like the standard percussive drills are the Leyner-Ingersoll water-drill and the new (1915) Sullivan mounted type of hammer drill. These machines are designed for tunneling or driving in medium hard rocks. Other American drills and some foreign drills, as the Stephens "Imperial" and the Kimber are cradle-mounted but in their method of operation they differ materially from the percussive drill.

Hand hammer drills may be divided into two classes with respect to the type of valve: Piston valves are those in which the differential piston or hammer acts as a valve. Examples of this type of drill are the Ingersoll-Rand "Imperial," the Waugh "Valveless Stoper" and the Hardsocg "Little Wonder." Drills with valves include the Ingersoll-Rand "Leyner-Ingersoll," the "Butterfly" hammer drill, "Crown" hammer (air valves), "Little Jap" (axial auxiliary valve), the Sullivan mounted type of hammer drill, the "Rotator," and air feed stopping drills (differential air valves), Chicago stopping drill, Waugh valve type, McKiernan-Terry "Rotating Hammer," the Cleveland Rock Drill Company hammer and the Stephens "Climax Imperial."

The piston acts as a hammer in a number of drills including the "Little Jap," Sullivan "DP33 Rotator," McKiernan-Terry "Rotating Hammer" and the Hardsocg "Little Wonder." In this type of machine the drill steel must necessarily have a

shoulder or collar to keep it from entering the cylinder. An anvil block to receive and transmit the blow of the piston is used in the "Butterfly" air-feed stopers, and the "Imperial" and "Crown" hammer drills of the Ingersoll-Rand Company, the Sullivan air-feed stoping drills, Chicago, Waugh, and Cleveland Rock Drill Company's stopers. No anvil block is used in the "Little Jap," Sullivan "Rotator," McKiernan-Terry "Rotating Hammer" or the Hardsocg, but the piston strikes directly on the end of the drill steel.

Rotation of hammer drills is generally accomplished by hand, some of the few American drills having automatic rotation, being the Leyner-Ingersoll drill, the Sullivan "D P-33 Rotator" and the Hardsocg machine.

The Sullivan D P-33 Rotator may be used either with hollow or with solid steels. Hollow steel drill rods are used in holes over 6 or 10 ft. long. The machine may be unmounted, or mounted on the telescopic or fishpole feed for shallow holes in drifting or stoping, or on a cradle or feed screw and shell mounting for deep hole drifting. Lubrication and rotation are automatic. The blow of the piston is cushioned in order to aid the return stroke. The drill steel is held in the chuck by a yoke which can be loosened by hand. The machine is generally operated by air power but can be used with steam, about 5 boiler hp. being required. The air consumption is about 70 cu. ft. at 85 lb. pressure.

Tables X and XI give data relative to different makes of hammer drills.

TABLE X. UNMOUNTED AIR HAMMER DRILLS

Item.	Manufacturer	Plug drill	Foot hole drill	Sullivan Machinery Company	Sinker	Hitch cutter	Rotator
1.	Catalog Name			Hand hammer	DB-21	DB-13	DP-33
2.	Number	DF-3 (DA-15)	DK-3 (DA-19)	DC-19	DB-21	Cutting bitches	General drill
3.	Use	Plug & feather	Foot holes	Block holes Sinking	Blast holes Sinking	Coal dr.	
4.	Length, in.	17.5	21.5	19	1	16	..
5.	Weight, lb.	2 1/2	4 1/2	27	69	14.5	38
6.	Cyl. diam. in.	1 1/2	1 1/2	1 5/8	2	1 1/2	2 1/2
7.	Cyl. stroke, in.	2 1/2	2 1/2	2 1/2	3 1/2	2 1/2	..
8.	Shape of steel	Round	Round	Hexagon	Hexagon	Special	Hexagon Special
9.	Size of steel, in.	1 1/16	27/32	1/2	1
10.	Hollow or solid	Solid	Solid	Hollow	Hollow	Solid	Hollow
11.	Size of shank, in.	11/16x2 1/2	27/32x3 1/2
12.	Depth of hole, ft.	0.5	1	0	0	..	10
13.	Diam. of hole, in.	3/4-1	3/4-1	1 1/2-2	2	..	1 1/2
14.	Cu. ft. of free air per minute	29	41	38	50	..	50
15.	Air pressure, lb.	30	30	30	30	..	90
16.	Rotation, hand or automatic	Hand	Hand	Hand	Hand	..	Auto
17.	Valve or valveless	Valve
18.	Approximate net price, \$	40	75	45	100	45	110

TABLE X. UNMOUNTED AIR HAMMER DRILLS — Continued

Item	Manufacturer	Plug drill	Ingersoll-Rand Co.	Butterfly	Jack-hammer	Bull-moose
1. Catalog Name	HA-14	MV-2	BA	BCR-430	BCR-53
2. Number	17.5	15	24	18	28
3. Use	feather	feather	Block holes	Sinking	Sinking
4. Use	feather	feather	Block holes	Sinking	Sinking
5. Length, in.	17.5	15	22.5	18	28
6. Weight, lb.	21	30	43-48	40	105
7. Cyl. diam. in.	1%	1 1/16	1 3/4	2 1/4	2 1/4
8. Cyl. stroke, in.	2%	2 1/2	3 1/2	2	2
9. Shape of steel	Square	Hexagon	Hexagon	Hexagon	Hexagon
10. Size of steel, in.	%	%	%	%	%
11. Hollow or solid	Solid	Hollow	Hollow	Hollow	Hollow
12. Size of shank, in.	11/16x2 1/2
13. Depth of hole, ft.	0.5	4	None	None	None
14. Diam of hole, in.	%-%	1-1 1/2	1	1 1/16	1 1/8x2 1/2
15. Cu. ft. of free air per minute	25	23	57	55	85
16. Air pressure, lb.	80b	90b	80b	90a	90b
17. Rotation, hand or automatic	Hand	Hand	Hand	Auto	Auto
18. Valve or valveless	Valve	None	Valve	Valve	Valve
19. Approximate net price, \$	50	60	75	100	200

a. Uses steam or air at 60 to 100 lb.

b. Use air at 80 to 100 lb.

Invincible
35
Plug &
feather
16%
21 1/2
1 1/2 x 1 1/2
2
2
4
Hexagon
1
Hollow
None
12
12
2
5
% to 1
.....
Hand
Valveless
\$50Jack-hammer
BCR-430
Sinking
18
40
2 1/4
2
2
Hexagon
%
Hollow
.....
12
2
55
85
90a
Auto
Valve
100Butterfly
BC
Block holes
24
54-65
2
4
Hexagon
1
Hollow
None
12
1
1 1/16
74
80b
Hand
Valve
100Ingersoll-Rand Co.
BA
Block holes
22.5
43-48
1 3/4
3 1/2
Hexagon
%
Hollow
None
12
1 1/2
57
80b
Hand
Valve
75MV-2
BA
Block holes
15
30
1 11/16
2 1/2
Hexagon
%
Hollow
.....
4
1-1 1/2
23
90b
Hand
None
60MV-1
MV-2
Plug &
feather
15
30
1 11/16
2 1/2
Hexagon
%
Hollow
.....
4
1-1 1/2
23
90b
Hand
None
60Imperial
MV-2
Plug &
feather
15
30
1 11/16
2 1/2
Hexagon
%
Hollow
.....
4
1-1 1/2
23
90b
Hand
None
60Imperial
MV-2
Plug &
feather
15
30
1 11/16
2 1/2
Hexagon
%
Hollow
.....
4
1-1 1/2
23
90b
Hand
None
60Imperial
MV-2
Plug &
feather
15
30
1 11/16
2 1/2
Hexagon
%
Hollow
.....
4
1-1 1/2
23
90b
Hand
None
60Imperial
MV-2
Plug &
feather
15
30
1 11/16
2 1/2
Hexagon
%
Hollow
.....
4
1-1 1/2
23
90b
Hand
None
60

TABLE X. UNMOUNTED AIR HAMMER DRILLS — Continued

Item.	Manufacturer	C-3	Busy Bee	McKiernan-Terry Drill Co.	Trow & Holden	Geo. Oldham
1.	Catalog Name
2.	Number
3.	Use
4.	Length, in.
5.	Weight, lb.
6.	Cyl. diam. in.
7.	Cyl. stroke, in.
8.	Shape of steel
9.	Size of steel, in.
10.	Hollow or solid
11.	Depth of hole, in.
12.	Diam. of hole, in.
13.	Cu. ft. of free air per minute
14.	Air pressure, lb.
15.	Rotation, hand or automatic
16.	Valve or valveless
17.	Approximate net price, \$
18.	
19.	

TABLE X. UNMOUNTED AIR HAMMER DRILLS — Continued.

Item.	Manufacturer	Chicago Pneumatic Tool Co.	Whitcomb Co.	Dallett Company
1.	Catalog name	Plug & Valveless hand tool	Hammer drill	Hand rock
2.	Number	No. 5	B-46	drill
3.	Use	Plug & feather	Sinking	Yankee B Plug & feather
4.	Length, in.	17	24	18 1/4
5.	Weight, lb.	22	43	24
6.	Cyl. diam. in.	1 1/2	2 1/2	1 1/2
7.	Cyl. stroke, in.	2	4	2 1/2
8.	Shape of steel	Hexagon	Hexagon	Hexagon
9.	Size of steel, in.	11/16	1	1
10.	Hollow or solid	Hollow	Hollow	Hollow
11.	Size of shank, in.	3/8	None	11/16
12.	Depth of hole, ft.	6	0-10	0.5
13.	Diam. of hole, in.	0.5	1 1/2	6
14.	Cu. ft. of free air per minute	34c	2	1
15.	Air pressure, lb.	75	50-75	15
16.	Rotation, hand or automatic	Hand	Hand	75-100
17.	Valve or valveless	None	Valve	Hand
18.	Approximate net price, \$	50	90	Valve
19.				25

c. Uses steam or air.

TABLE X. UNMOUNTED AIR HAMMER DRILLS — Continued

Item	Manufacturer	Sinker	Sinking	Hardseog Wonder Drill Company Sinker 65A	Plug & feather	Sinker	Sinking	Round Square	Hexagon	7/8 Hollow	7/8 Hollow	Hexagon	7/8-1 Hollow	None	Hand Valve
1. Manufacturer	Denver R. D. Mfg. Co.														
2. Catalog name	Waugh plugger														
3. Number	80P	90	21	20	18	20	20	80	80	80	80	80	80	80	80
4. Use	Block holes	Sinking	40	29	22	29	29	85	85	85	85	85	85	85	85
5. Length, in.	24	21	21	20	18	20	20	80	80	80	80	80	80	80	80
6. Weight, lb.	33	40	40	29	22	29	29	85	85	85	85	85	85	85	85
7. Cut diam. in.	1 1/2	1 1/2	1 1/2	1 1/2	1 1/2	1 1/2	1 1/2	1 1/2	1 1/2	1 1/2	1 1/2	1 1/2	1 1/2	1 1/2	1 1/2
8. Cut stroke, in.	1 1/2	1 1/2	1 1/2	1 1/2	1 1/2	1 1/2	1 1/2	1 1/2	1 1/2	1 1/2	1 1/2	1 1/2	1 1/2	1 1/2	1 1/2
9. Shape of steel	Hexagon	Hexagon	Hexagon	Hexagon	Hexagon	Hexagon	Hexagon	Hexagon	Hexagon	Hexagon	Hexagon	Hexagon	Hexagon	Hexagon	Hexagon
10. Size of steel, in.	7/8-1	7/8-1	7/8-1	7/8-1	7/8-1	7/8-1	7/8-1	7/8-1	7/8-1	7/8-1	7/8-1	7/8-1	7/8-1	7/8-1	7/8-1
11. Hollow or solid	Hollow	Hollow	Hollow	Hollow	Hollow	Hollow	Hollow	Solid	Solid	Solid	Solid	Solid	Solid	Solid	Solid
12. Size of shank, in.	3, 3 1/4, or 3 1/2	3, 3 1/4, or 3 1/2	3, 3 1/4, or 3 1/2	3, 3 1/4, or 3 1/2	3, 3 1/4, or 3 1/2	3, 3 1/4, or 3 1/2	3, 3 1/4, or 3 1/2	3, 3 1/4, or 3 1/2	3, 3 1/4, or 3 1/2	3, 3 1/4, or 3 1/2	3, 3 1/4, or 3 1/2	3, 3 1/4, or 3 1/2	3, 3 1/4, or 3 1/2	3, 3 1/4, or 3 1/2	3, 3 1/4, or 3 1/2
13. Depth of hole, ft.	6-10	6-10	6-10	6-10	6-10	6-10	6-10	6-10	6-10	6-10	6-10	6-10	6-10	6-10	6-10
14. Diam. of hole, in.	7/8-1	7/8-1	7/8-1	7/8-1	7/8-1	7/8-1	7/8-1	7/8-1	7/8-1	7/8-1	7/8-1	7/8-1	7/8-1	7/8-1	7/8-1
15. Cut. ft. of free air per minute	85	85	85	85	85	85	85	85	85	85	85	85	85	85	85
16. Air pressure, lb.	Auto	Auto	Auto	Auto	Auto	Auto	Auto	Auto	Auto	Auto	Auto	Auto	Auto	Auto	Auto
17. Rotation, hand or automatic	None	None	None	None	None	None	None	None	None	None	None	None	None	None	None
18. Valve or valveless	85	85	85	85	85	85	85	85	85	85	85	85	85	85	85
19. Approximate net price, \$	85	85	85	85	85	85	85	85	85	85	85	85	85	85	85

18.

TABLE X. UNMOUNTED AIR HAMMER DRILLS — Continued

Item.	Manufacturer	Kotten Company	Cleveland Rock Drill Co.
1. Catalog name	Plug drill	Hand Sinks	Hand Sinks
2. Number	18	25H	30H
3. Length, in.	21	Block holes & general drilling	Block holes & general drilling
4. Weight, lb.	1%	22	42
5. Cyl. diam. in.	2 1/2	30	60
6. Cyl. stroke, in.	2 1/2	15 1/8	1%
7. Shape of steel	Round	5	3-3 1/2
8. Size of steel, in.	%	Hexagon	Hexagon
9. Hollow or solid	Solid	1	1
10. Size of shank, in.	1 x 3 1/4	Hollow	Hollow
11. Depth of hole, ft.	1.5	None	None
12. Diam. of hole, in.	1.5	6	8
13. Cu. ft. of free air per minute	12	1%	1%
14. Air pressure, lb.	75-85	30	40
15. Rotation, hand or automatic	Hand	50-80	80
16. Valve or valveless	Hand Valve	Hand Valve	Hand Valve
17. Approximate net price, \$	25	50

TABLE XI. AIR-FEED OR CRADLE-MOUNTED HAMMER DRILLS

Item	Manufacturer	Model	Length, in.	Length of feed, in.	Weight, lb.	Cylinder diam., in.	Cylinder stroke, in.	Shape of steel, in.	Size of shank, in.	Hollow or solid	Size of hole, ft.	Size of hole, in.	Cu. ft. of free air per min.	Air pressure, lb.	Rotation, hand or auto	Valve or valveless	Approximate net price, \$	Company	Model	Weight, lb.	Cylinder diam., in.	Cylinder stroke, in.	Shape of steel, in.	Size of shank, in.	Hollow or solid	Size of hole, ft.	Size of hole, in.	Cu. ft. of free air per min.	Air pressure, lb.	Rotation, hand or auto	Valve or valveless	Approximate net price, \$
1.	Leyner-Ingersoll Water Drill	18	47 $\frac{3}{4}$	24-30	160	2 $\frac{1}{2}$	3a	round	1 $\frac{1}{4}$	hollow	6-9	1 $\frac{1}{4}$ -2 $\frac{1}{2}$	valve	300	Ingersoll-Rund Company	Butterfly BC-20	22	2 $\frac{1}{2}$	72-88	any	1	solid	12	80	hand valve	145		
2.	Leyner-Ingersoll Water Drill	18	47 $\frac{3}{4}$	24-30	160	2 $\frac{1}{2}$	3a	round	1 $\frac{1}{4}$	hollow	6-9	1 $\frac{1}{4}$ -2 $\frac{1}{2}$	valve	300	Ingersoll-Rund Company	Butterfly BC-21-22	55 $\frac{1}{2}$	2 $\frac{1}{2}$	72-88	any	1	solid	12	80	hand valve	145		
3.	Imperial	MC-30	56 $\frac{1}{4}$	70	17 $\frac{1}{16}$	2 $\frac{1}{16}$	1 $\frac{1}{16}$	cruciform	3 $\frac{1}{2}$	hollow	83	hand	none	135	Imperial	MC-32	22	2 $\frac{1}{2}$	70	any	1	hollow		
4.	Stopchamer	CC-10-11-12	52 $\frac{1}{4}$	81	Stopchamer	CC-10-11-12	22	2 $\frac{1}{2}$	81	any	1	hex. or cruciform	
5.	Stopchamer	CC-10-11-12	52 $\frac{1}{4}$	81	Stopchamer	CC-10-11-12	22	2 $\frac{1}{2}$	81	any	1	hex. or cruciform	
6.	Stopchamer	CC-10-11-12	52 $\frac{1}{4}$	81	Stopchamer	CC-10-11-12	22	2 $\frac{1}{2}$	81	any	1	hex. or cruciform	
7.	Stopchamer	CC-10-11-12	52 $\frac{1}{4}$	81	Stopchamer	CC-10-11-12	22	2 $\frac{1}{2}$	81	any	1	hex. or cruciform	
8.	Stopchamer	CC-10-11-12	52 $\frac{1}{4}$	81	Stopchamer	CC-10-11-12	22	2 $\frac{1}{2}$	81	any	1	hex. or cruciform	
9.	Stopchamer	CC-10-11-12	52 $\frac{1}{4}$	81	Stopchamer	CC-10-11-12	22	2 $\frac{1}{2}$	81	any	1	hex. or cruciform	
10.	Stopchamer	CC-10-11-12	52 $\frac{1}{4}$	81	Stopchamer	CC-10-11-12	22	2 $\frac{1}{2}$	81	any	1	hex. or cruciform	
11.	Stopchamer	CC-10-11-12	52 $\frac{1}{4}$	81	Stopchamer	CC-10-11-12	22	2 $\frac{1}{2}$	81	any	1	hex. or cruciform	
12.	Stopchamer	CC-10-11-12	52 $\frac{1}{4}$	81	Stopchamer	CC-10-11-12	22	2 $\frac{1}{2}$	81	any	1	hex. or cruciform	
13.	Stopchamer	CC-10-11-12	52 $\frac{1}{4}$	81	Stopchamer	CC-10-11-12	22	2 $\frac{1}{2}$	81	any	1	hex. or cruciform	
14.	Stopchamer	CC-10-11-12	52 $\frac{1}{4}$	81	Stopchamer	CC-10-11-12	22	2 $\frac{1}{2}$	81	any	1	hex. or cruciform	
15.	Stopchamer	CC-10-11-12	52 $\frac{1}{4}$	81	Stopchamer	CC-10-11-12	22	2 $\frac{1}{2}$	81	any	1	hex. or cruciform	
16.	Stopchamer	CC-10-11-12	52 $\frac{1}{4}$	81	Stopchamer	CC-10-11-12	22	2 $\frac{1}{2}$	81	any	1	hex. or cruciform	
17.	Stopchamer	CC-10-11-12	52 $\frac{1}{4}$	81	Stopchamer	CC-10-11-12	22	2 $\frac{1}{2}$	81	any	1	hex. or cruciform	
18.	Stopchamer	CC-10-11-12	52 $\frac{1}{4}$	81	Stopchamer	CC-10-11-12	22	2 $\frac{1}{2}$	81	any	1	hex. or cruciform	
19.	Stopchamer	CC-10-11-12	52 $\frac{1}{4}$	81	Stopchamer	CC-10-11-12	22	2 $\frac{1}{2}$	81	any	1	hex. or cruciform	
20.	Stopchamer	CC-10-11-12	52 $\frac{1}{4}$	81	Stopchamer	CC-10-11-12	22	2 $\frac{1}{2}$	81	any	1	hex. or cruciform	
21.	Stopchamer	CC-10-11-12	52 $\frac{1}{4}$	81	Stopchamer	CC-10-11-12	22	2 $\frac{1}{2}$	81	any	1	hex. or cruciform	
22.	Stopchamer	CC-10-11-12	52 $\frac{1}{4}$	81	Stopchamer	CC-10-11-12	22	2 $\frac{1}{2}$	81	any	1	hex. or cruciform	

* $\frac{1}{2}$ air, $\frac{1}{2}$ water.
 a Piston displacement, 14.7 cu. ft.
 b Piston displacement, 12.6 cu. ft.

TABLE XI. AIR-FEED OR CRADLE-MOUNTED HAMMER DRILLS — Continued

Item	Manufacturer	Mounted hammer	Rotator	Sullivan Machinery Company.	Heavy	Air jet
1.	Catalog name	DR6	DF33	Standard	Sloper	Sloper
3.	Model	DA21	DA21	DF21	DG21	DC21
4.	Principal use	Drifting	Drifting	Sloping	Sloping	Sloping
7.	Length of feed, in.	146	38	12	12	12
8.	Weight, lb.	2 ¹ / ₂	2 ¹ / ₂	83	80	80
9.	Cylinder diam., in.	2 ¹ / ₁₆	2 ¹ / ₁₆	-1 ¹ / ₁₆
10.	Cylinder stroke, in.	round	hexagon	cruciform	cruciform	cruciform
11.	Shape of steel, in.	1 ³ / ₄
12.	Size of steel, in.	hollow	hollow	solid	solid	hollow
13.	Hollow or solid	1 ³ / ₄ x 1 ¹ / ₁₆	6-10	none	none	none
14.	Size of shank, in.	1 ¹ / ₂ x 1 ¹ / ₁₆	1 ¹ / ₄	8	8	8
15.	Depth of hole, ft.	12	1 ¹ / ₄	2	2	2
16.	Size of hole, in.	2 ¹ / ₄	50
17.	Cu. ft. of free air per min.	70d	90
18.	Air pressure, lb.	85
19.	Size of air inlet, in.
20.	Rotation, hand or auto	auto	auto	hand	hand	hand
21.	Valve or valveless	valve	valve	valve	valve	valve
22.	Approximate net price, \$	250	110-200	185	135	150

d Steam, 5 b hp. can be used.

TABLE XI. AIR-FEED OR CRADLE MOUNTED HAMMER DRILLS — Continued

Item.	Manufacturer	Little Miner	Cleveland Stoper	Rock Drill Co. Stoper	Column drill
1. Catalog name	23CS
3. Model	40G	50C	50
5. Length, in.	58	57	50
7. Length of feed, in.	18	18	24
8. Weight, lb.	70	85	55
9. Cylinder diam., in.	2	2 1/4	1 1/16
10. Cylinder stroke, in.	3	3	5
11. Shape of steel, in.	hexagon	cruciform	cruciform	hexagon
12. Size of steel, in.	5/8	1-1 1/2	1-1 1/2	5/8
13. Hollow or solid	solid	solid	solid	hollow
14. Size of shank, in.	none	none	none	none
15. Depth of hole, ft.	10	10	10	8
16. Size of hole, in.	1 1/4	1 1/4	1 1/4	1 1/4
17. Cu. ft. of free air per min.	55	60	80	55
18. Air pressure, lb.	80	80	80	80
19. Size of air inlet, in.	7/16	1/2	1/2	7/16
20. Rotation, hand or auto	hand	hand	hand	hand
21. Valve or valveless	valve	valve	valve	valve
22. Approximate net price, \$	125	135	135	125 f

f Column \$35.

TABLE XI. AIR-FEED OR CRADLE-MOUNTED HAMMER DRILLS — Continued

Item.	Manufacturer	Chic. Pneu. Tool Co.	McKiernan-Terry Company	Stopper	Stopper	Rotating hammer Drifter	Combination	Stopper
1.	Cataloz name	B44	A345	A4	A5	A345	B5	B5
2.	Model	B44	A345	A4	A5	A345	B5	B5
3.	Length, in.	54	63	63	63	27-63
5.	Length of feed, in.	22	29	29	29	29
7.	Weight, lb.	70	124	100	124	213	75	75
8.	Cylinder diam., in.	2 1/2	2	2	2	2	1 1/16	1 1/16
9.	Cylinder stroke, in.	4	3	3	3	3	5	5
10.	Shape of steel, in.	any	hexagon e	hexagon e	hexagon e	hexagon e	hexagon e	hexagon e
11.	Size of steel, in.	1-1/4	1	1	1	1	1	1
12.	If hollow or solid	solid	hollow	hollow	hollow	hollow	hollow	hollow
13.	Size of shank, in.	none
14.	Depth of hole, ft.	8	12	12	12	12	6-8	6-8
15.	Size of hole, in.	17/16	1 1/4	1 1/4
16.	Size of hole, in.	8	8	8	8	8	8	8
17.	Cu. ft. of free air per min.	59	75	75	75	75	70	70
18.	Air pressure, lb.	80	80	80	80	80	80	80
19.	Size of air inlet, in.	3/4	3/4	3/4	3/4	3/4	3/4	3/4
20.	Rotation, hand or auto	hand	auto	auto	auto	auto	hand	hand
21.	Valve or valveless	valve	valve	valve	valve	valve	valve	valve
22.	Approximate net price, \$	150	175	175	195	225	225	125

e Or 3/4 quarter octagon.

TABLE XI. AIR-FEED OR CRADLE MOUNTED HAMMER DRILLS — Continued

Item.	Manufacturer	Whitcomb, hammer	Denver Rock Drill Company
1. Catalog name	Stoper	Stoper	Stoper
2. Model	8C	12A	14A
3. Principal use	stopping	stopping	stopping
	upraising	upraising	upraising
4. Length, in.	54	56	56
5. Weight, lb.	24	24	24
6. Cylinder diam., in.	74	78	90
7. Cylinder stroke, in.	2	2½	2½
8. Shape of steel, in.	2	3	4
9. Size of steel, in.	1-1½	cruciform	cruciform
10. Hollow or solid	solid	solid	solid
11. Depth of hole, ft.	none	none	none
12. Size of hole, in.	4-8	4-8	4-8
13. Cu. ft. of free air per min.	1½	1½	1½
14. Air pressure, lb.	35	56	67
15. Size of air inlet, in.	80	80	80
16. Rotation, hand or auto	hand	7/16	9/16
17. Valve or valveless	valve	hand	hand
18. Approximate net price, \$	135	135	150

TABLE XI. AIR-FEED OR CRADLE MOUNTED HAMMER DRILLS — Continued

Item	Manufacturer	Stoper	Waugh drills	Drifter
1. Manufacturer		16V	17V	3D
2. Catalog name		stopping	stopping	sinking
3. Model		upraising	stopping	drifting
4. Principal use				stopping
5. Length, in.	55	53	55	54
7. Weight of feed, in.	24	24	24	20
8. Weight, lb.	72	80	80	78
9. Cylinder diam., in.	2 3/4	2 3/4	2 3/4	2 3/4
10. Cylinder stroke, in.	3 3/8	3	3	3
11. Shape of steel, in.	cruciform	cruciform	cruciform	hexagon
12. Size of steel, in.	1	1-1 1/2	1 1/2-1 3/4	1-1 1/2
13. Hollow or solid	solid	solid	solid	hollow
14. Size of shank, in.	none	none	none	none
15. Depth of hole, ft.	4-8	4-8	4-8	8-10
16. Size of hole, in.	1 3/8	1 3/8	1 3/8	1 3/8
17. Cu. ft. of free air per min.	29	50	49	60
18. Air pressure, lb.	50	80	80	80
19. Size of air inlet, in.	7/16	1/2	1/2	1/2
20. Rotation, hand or auto	hand	hand	hand	hand
21. Valve or valveless	none	none	none	none
22. Approximate net price, \$	135	135	135	150

Comparative Worth of Hammer and Percussive Drills. Hammer drills are not as durable as percussive drills and cannot be subjected to as much abuse. The parts of the hammer drill are

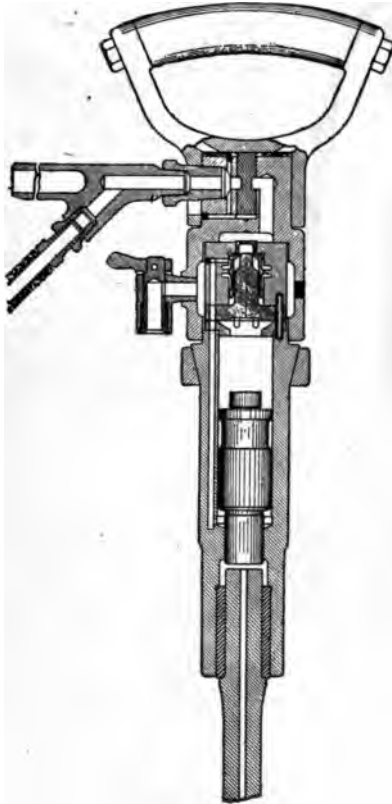

Fig. 27. Sullivan Hand Hammer Drill—DC-19.

lighter and generally more complicated than those of the percussive drill. The steel of the piston and of the anvil block is subject to crystallization, due to the many rapid blows it receives. The hollow steel drill rods generally used are higher priced and are difficult to sharpen as compared with solid steel. The length of feed of hammer drills is generally much shorter than that of percussive drills, and the time consumed in changing

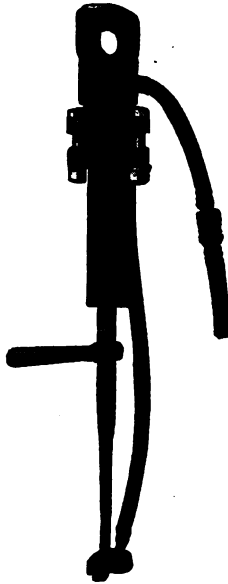

Fig. 28 Sullivan
"Plug" Drill

steel and in transporting and shortening them is considerably higher than with the reciprocating machine. Furthermore, the short feed increases the danger of having the cylinder head cracked by the piston, especially when the machine is being handled by an inexperienced man. Most important of all, the hammer drill, while the more rapid driller in horizontal or "dry" holes, is much slower than the percussion drill in "down" holes, the kind common in open cut work.

On the other hand, for drilling plug holes, plug-and-feather holes, or holes in small trenches or other restricted situations, its lightness and ease of handling, and the fact that many models require no mounting, makes the hammer drill a valuable machine.

Handling a Hammer Drill. While it is true that more care must be taken in setting up a piston drill on a column or bar than must be exercised in the case of the lighter hammer drill, on account of the "back-kick" of the heavier machine, yet it is absolutely necessary to

see that the hammer drill is held firmly in place. The light machine vibrates much more than does the heavy piston drill, and is therefore more likely to work out of alignment if not properly secured.

It is very easy to start a hole with a hammer drill even on a badly slanting surface, and after the hole is "collared" it is much more rapidly "run-down" with a hammer drill than with a piston drill.

It must be remembered, especially by those who are versed in the use of the piston machine and unexperienced with the hammer drill, that the latter is a comparatively delicate piece of mechanism and cannot, with impunity, be "cleaned up with a sledge hammer and wiped off with a scoop shovel." Mr. James E. Harding cites a case where the repair bill of a single hammer drill for one month amounted to over \$280, caused almost entirely by a poor runner.

A piston machine is cranked by feel as well as by sound, but a hammer drill is cranked by ear alone and should give out a clear,

high-keyed ring when running neither too close nor too far from the ground.

In the smaller sizes of hammer drill the steel is turned by the operator with a wrench, Fig. 28.

Hammer Drill Mountings. These are the cradle, column, or

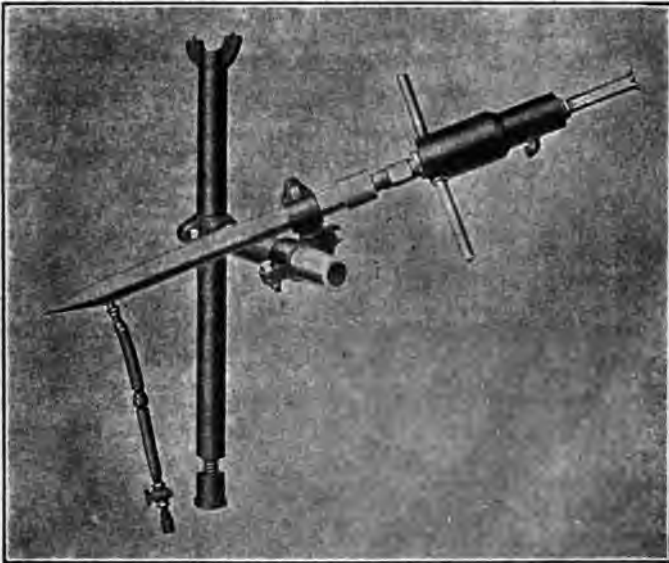

Fig. 30. Hardscoeg Wonder Air Hammer Drill on a Column.

bar mountings, and the air-feeding mounting and the "fish-pole" mounting.

The Telescopic Air-feed is a telescoping bar which is extended until one end rests firmly upon the floor or wall, the other end being clamped to the drilling machine. The machine is thus held steadily by air pressure in the air-feed mounting at one end and by the drill steel in the hole at the other end.

The Fish Pole Mounting is a light portable telescopic column whose piston ends in a hook; the drill is hung from the hook end by a clamp that engages one of the side rods. The weight of the drill is supported by a strong spring placed in the column below the piston rod. In operation the drill runner adjusts the support to the proper height by manipulating the upper hand screw, and "collars" the hole, after the lower hand set screw is released and the spring is allowed to take the weight of the drill. Proper

alignment of the hole is maintained by pressing the tool down slightly against the spring.

The Cradle or Shell Mounting is a more permanent form of mounting than the "fishpole" type. It consists of a skeleton-shell feed-screw, equipped with two hinged clamps. One of these is at the side of the shell and fits over the cylinder of the drill. The other engages the handle of the tool. Both are readily tightened by hand set screws so that the drill is held firmly in position. The shell is equipped with a standard rock drill trunnion and may be used on almost any column or tripod saddle, except those of the largest special sizes. The drill is handled on this mounting like a percussive drill, being fed forward and back on the feed screw by the crank handle. The cradle mounting weighs about 60 lb.

A Method of Handling Drills in Shaft Sinking. In a paper by J. M. Brown, read before Lake Superior Mining Institute, the following facts were given:

The shaft was vertical and its overall dimensions were 13 ft. 1 in. by 21 ft. 1 in. It was being sunk by the Newport Mining Co., at Ironwood, Mich. The novel feature of its excavation was the use of so-called "headers" to support and supply a number of drills each. The sketch, Fig. 31, shows a "header" with a single drill attached. When ready to drill, all that was necessary was to remove the Jackhammer from the hook and pull downward, the counter weight *F* keeping the slack hose out of the way while drilling.

A is a casting 9 in. in diameter, bored out in the center, and having a bolt circle of a standard 4-in. flange. Eight holes evenly spaced are drilled in the sides and tapped for $\frac{3}{4}$ -in. nipples, to which the machine hose connections are made. *B* is a duplicate of *A* with the exception that the holes for the nipples are of different size. There are seven $\frac{1}{2}$ -in. connections and one 1-in., the latter being an inlet for the water and the others for water discharges to the drills. The hooks or hangers marked *C*, are made of $\frac{3}{8}$ -in. x 2-in. strap iron. There are four straps with a hook on each end. *A*, *B*, and *C* are all held together by four $\frac{3}{4}$ -in. bolts passing through the 4 in. flange at the bottom of the 4-in. air pipe *E*. The ell at the top is made special, with a lug cast on it to accommodate the 1-in. eye bolt by means of which the "header" is suspended. *D* is a 9-in. pipe which serves as a casing to enclose the counter-weights, *E*.

Two of these headers were used. Each would accommodate seven Jackhammers and one blowpipe, but only six machines were used on each. When not in use the "headers" were hung off to one side in the headframe and could be easily lowered by means of a sling beneath the bucket. While in use they hung on a small

chain-block fastened to the bottom shaft set. By means of this chain-block the apparatus could be brought to any desired height, the adjustment allowed by the use of a 3-in. air hose *H* which connected to the air main, the bottom of which was always far enough up the shaft to avoid any severe blows during blasting. One of these outfits could be taken from its position on surface and placed on the chain-block below, ready for drilling in less than five minutes, only one connection being necessary to make.

Use of Water Jets in Drilling. A simple and very effective method of increasing the number of feet of hole drilled in soft rock is the use of a water jet to wash the sludge out of the hole as fast as it forms.

The advantage of a water jet for removing the rock chips from the bottom of a drill hole, as rapidly as they are formed, is not necessarily confined to drilling in shales and other soft rock. It is my conviction that a water jet will greatly increase the number of feet of hole drilled in almost any kind of rock, provided a jet of proper volume is used, and provided also that the drill bit is so designed as to break up large chips as the jet can lift. Instead of pulverising all the rock as in a mortar, with the drill bit as the pestle, the attempt should be made to loosen fairly large chips of rock and remove them immediately by an upward rising current of water. The success of this method in the hard gneiss rock of New York City was established by Maj. Derby (see page 45), who used a special hollow bit with a crown-shaped cutting edge.

Contractors and engineers are prone to cling to the old ways of doing work, particularly if their foremen insist that they have tried other ways with poor results. The truth is that the aver-

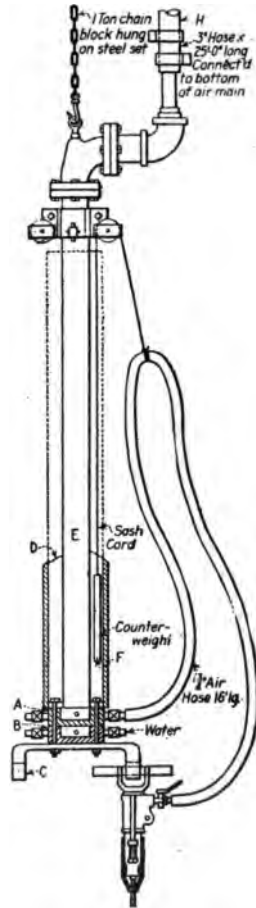

Fig. 31. Drill Connection Used in Sinking a Mine Shaft.

age foreman is not fit to be trusted with the carrying out of any experiments designed to secure greater economy, unless he is directly under the eyes of the man who has planned the experiments. Rock is so variable in different localities that experimenting should always be conducted, not only as to kinds of tools and methods of drilling, but as to blasting. In the literature on rock work, there are numerous records of experiments that have led to remarkable decreases in the cost of excavation, so that there is no good excuse for timidity in trying methods that are new. The fact is that economic methods new to men in a certain locality are often old to men not far distant, and then the excuse for failure to have adopted the economic methods is lame indeed.

On certain work in the shale rock of upper New York State (1908) the contractors struggled with the difficulty of small daily output of drill hole, due to rapid accumulation of sludge and clogging of bits. The author had been called in to suggest methods of reducing the cost of the excavation, and he inquired whether water jets had been tried as a means of washing the drill holes clean. He was told that the trial had been made on several different contracts, but always without success. An investigation disclosed, however, that the water jets had been of insufficient velocity to lift the large chips from the bottom of the drill hole. When water at greater pressure was used, the trouble disappeared at once, and the steam drills more than doubled their daily output of hole drilled.

In *Engineering and Contracting*, Feb. 5, 1908, a formula was deduced by the author for determining the amount of water required per minute to lift chips of any given size from a drill hole of any given diameter.

Usually, however, a little experimenting with the water pressure and with the size of pipe delivering the water will solve the problem quite as satisfactorily as by the use of the formula, but it is well for an engineer to understand the formula, since it gives a correct theory upon which to base experiments.

Rule: To ascertain the number of gallons of water per minute required to remove sludge from a drill hole, by means of a vertically rising current of water, square the diameter of the drill hole at its mouth (the diameter being measured in inches), subtract the square of the diameter of the drill steel measured in inches, multiply by the square root of the diameter of the largest grain or particle of sludge (also measured in inches or fractions of an inch); and then multiply by 7.

Example: A drill hole is 3 in. in diameter at its mouth, the diameter of the drill steel is $\frac{3}{4}$ in., and the largest grain of sludge (that is, the largest chip of rock) is $\frac{1}{20}$ in. in diameter. How many gallons of water must a water jet deliver per minute?

According to the rule, square 3 and the result is 9, square $\frac{3}{4}$ and the result is 0.56 which, subtracted from 9 leaves 8.44. Take the square root of $\frac{1}{20}$, which is 0.224. Then multiply the 8.44 by the 0.224 by 7, and the product is 13.2 gallons per minute.

It will be noted that the quantity of water required increases almost as the square of the diameter of the hole, so that doubling the diameter of a drill hole (at its mouth) increases the amount of water four times. It will also be noted that the amount of water required increases as the square root of the diameter of the largest grain or chip of rock to be elevated. Hence a chip four times as large will require only twice as much water.

The solution of this problem is as follows:

When grains of rock or sand are allowed to drop vertically through still water, a maximum velocity is quickly attained, after which they fall with a uniform velocity through the water. If the grains are large, the velocity is greater than if they are small. Grains having a high specific gravity fall faster than grains having a low specific gravity. About 1870 a German mining engineer, Rittinger, made some experiments upon grains of different sizes up to about 0.4 in. in diameter, and deduced the following formula from his experiments:

$$v = 15.4 \sqrt{d(G-1)}$$

v = velocity of the grain, in inches, per second.

d = diameter of the grain, in inches.

G = specific gravity of the grain.

This formula relates to "average grains" and gives their velocity when falling through still water after they have attained a constant velocity. Rounded grains have a velocity about 10% greater, and flat grains have a velocity about 20% less than "average grains."

In 1894, *Transactions, American Institute of Mining Engineers*, Vol. 24, p. 409, Prof. Robert H. Richards made public the results of a large number of experiments on grains falling through water. The grains were all very small, none being larger than 0.08 in. They were allowed to fall through 8 ft. of water. Richards found that for quartz grains the velocity was:

$$v = 30 \sqrt{d}$$

According to Rittinger, with quartz having a specific gravity of 2.64, the velocity would be:

$$v = 20 \sqrt{d}$$

Since we rarely have to excavate rock much heavier than quartz, it will ordinarily be safe to use Richards' formula —

$$v = 30 \sqrt{d}$$

In order to lift grains of rock vertically by means of an upward rising current of water, the velocity of the water must ex-

ceed the velocity that those grains would attain when falling through still water.

This is clearly the fundamental principle to be used in calculating the quantity of water required to keep a drill hole free of sludge by means of a water jet. Let A be the area in square inches of the drill hole at its mouth, then:

$$(1) \quad A = \frac{\pi D^2}{4} - \frac{\pi d_1^2}{4}$$

where D being the diameter of the hole in inches, and d_1 = diameter of drill steel.

Let Q be the number of gallons of water per minute rising through the drill hole, as delivered by the water jet, then:

$$(2) \quad Q = 60 \times \frac{v A}{231}$$

v being the velocity of the rising current of water in inches per second. There are 231 cu. in. per gallon, hence the 231 in the denominator. The 60 in the numerator is introduced to reduce a velocity (v) of inches per second to inches per minute.

Substituting for A its value given in equation (1), we have:

$$(3) \quad Q = \frac{60 v}{231} \times \frac{\pi (D^2 - d_1^2)}{4}$$

Now, according to Richards' formula for the velocity of grains falling through still water, we have:

$$(4) \quad v = 30 \sqrt{d}$$

If the v in equation (3) is equal to the v in equation (4), we shall have barely enough water rising through the drill hole to elevate grains of sludge having a diameter d . Hence combining equations (3) and (4), we have:

$$(5) \quad Q = 60 \times 30 \frac{\sqrt{d}}{231} \times \frac{\pi (D^2 - d_1^2)}{4}$$

Substituting for π its value 3.14, we have:

$$(6) \quad Q = 6.1 (D^2 - d_1^2) \sqrt{d}$$

In order to provide a small factor of safety that will insure the delivery of the grains of sludge at the mouth of the drill hole, let us substitute 7 for the 6.1 in equation (6). Then we have:

$$(7) \quad Q = 7 (D^2 - d_1^2) \sqrt{d}$$

Q = gallons of water per minute.

D = diameter of mouth of drill hole in inches.

d = diameter of largest grain of sludge in inches.

d_1 = diameter of drill steel in inches.

Formula (7) is the formula upon which the rule, above given, is based, and is not only perfectly reliable, but is, I believe, a rational solution of a problem that has never been solved before.

In very tough rock the grains of sludge are often exceedingly small. Assuming that the largest grains to be elevated by the water jet are one-hundredth of an inch in diameter and that the hole is $2\frac{1}{2}$ ins. diameter, and applying equation (7), we have:

$$Q = 7 \times (2.5^2 - 0.875^2) \sqrt{\frac{1}{100}} = 3.84 \text{ gals. per min.}$$

In very soft rocks, like shale, the grains of sludge are often exceedingly large; and, as we have seen in applying the rule above, it will take 13 gals. per minute to elevate rock chips $\frac{1}{4}$ in. diameter through a drill hole $2\frac{1}{2}$ ins. diameter at its mouth.

Should the specific gravity of the rock be greater than 2.6, my formula (eq. 7) must be modified in accordance with Ritter's formula for grains falling in water, above given.

From the foregoing we see that the diameter of the drill rod may usually be neglected and the rule then reduces to the following:

Square the diameter (inches) of the drill hole at its mouth and multiply by the square root of the diameter (in inches) of the largest grains of sludge, and then multiply again by seven. The result is gallons of water per minute.

From the author's foregoing formulas the accompanying diagram, Fig. 32, entitled "Chart showing the quantity of water in gallons per minute required to remove particles of sludge from drill holes," was drawn and it is abstracted from "Rock Drilling" by Dana and Saunders. To use this chart, obtain the squares of the diameters of the hole, of the drill steel and of the grains of sludge. In the foregoing example, in which the diameter of the hole at the top is 3 in., of the drill steel, $\frac{3}{4}$ in., and of the sludge $\frac{1}{20}$ in. then $D^2 - d_2^2 = 8.44$ sq. in. This is so nearly 9 sq. in. that on the diagram we can use the line representing 9 sq. in. which cuts the vertical line for a diameter of grain equivalent to a $\frac{1}{20}$ in. at the point corresponding to 14.1 gallons per minute. The theoretical amount of water necessary, then, is a little less than 14 gallons per minute.

In practice, when working in the hole the portion of the bit at the point of the drill is in a very much more confined space than above. In addition to this the drill is rapidly churning the water at the bottom of the hole, so that large particles will be caused to float in the hole above the bottom, but will not be lifted out by the upward current of water. It thus happens that upon stopping the drill to change bits it is advisable to put an extra jet into the hole while the helper is cranking up, in order to wash out as many of the large particles as possible. At the best, with an ordinary jet there will be a considerable number of grains, varying from $\frac{1}{8}$ in. up in the very soft rocks, which settle down into the holes, after the bit has been withdrawn, to a depth of one or two inches. These cannot easily be removed by the pump

When the following bit is dropped into the hole if it does not descend sufficiently to admit of the drill chuck passing over the shank, it can be immediately caused to settle down by pushing one of the jet pipes into the hole. As soon as the jet is within a few inches of the bottom it stirs up the small particles of broken stone and the bit then descends by its own weight. It takes but a minute to teach the ordinary drill runner this trick, but usually he will discover it himself in the first few minutes of work.

The first thing that the fresh bit does after getting to work is to break up these pieces which the jet will then take out of the hole. It should be noted that when operated in this manner there is practically no pumping to be done, and thus the time of changing bits can be materially reduced.

Attention will be called to the use of hollow drill steel and a special arrangement for jetting water into the hole through the bits. If this equipment is not at hand, the best arrangement is to use a half-inch hose as long as may be necessary with a 30-in. length of $\frac{3}{8}$ -in. iron pipe inserted about 3 in. in the end of the hose. When a small hole is drilled it is sometimes advisable to have the blacksmith taper the $\frac{3}{8}$ -in. pipe slightly, but when the smallest bit has a diameter of $2\frac{1}{4}$ in. this is not necessary.

To fasten the pipe into the hose it is only necessary to pull the rubber over the end of the pipe for about 3 ins. When in the drill hole, if the pipe is pulled, the rubber contracts around the end of the pipe, thus holding it very firmly. The weight of the pipe keeps the hose down in the hole and by reducing the diameter of the stream gives an extra speed to the water where speed will do the most good. The working of the bit keeps the end of the pipe from descending lower than about 6 in. above the bottom of the hole.

It is often difficult to get sufficient head of water to work such a jet to the best of advantage excepting in hard rocks, unless a force pump is used. A small Deane Duplex pump with $2\frac{1}{4} \times 4$ in. cylinders running at 90 revs. per min. will operate six jets. At this speed each jet threw about 6 gallons per min. with a pressure of about 100 lbs. per sq. in. through a 50-ft. length of the half-inch hose, which was coupled to a "manifold," taking water from a 1-in. discharge pipe from the pump. When the pump was operated at a higher speed than this it was found that the hose had a tendency to twist and squirm so that with this arrangement 6 gallons of water per min. is about the limit for one jet.

For grains of rock with a diameter of 0.1 in., reference to the *diagram, Fig. 32*, shows that the expression $D^2 - d^2$ must be about 3 sq. in. for one jet or about 6 sq. in. for two jets. The use of this arrangement is not practical in holes of so small an

area, consequently the larger grains will never entirely be removed from the hole by the jet.

Where a 3-in. bit and two jets are used, the largest average diameter of a piece that will come out of the top of the hole is about 0.05 in.

The facts above enumerated explain why the use of a water jet has been condemned in the soft rocks by many so-called "practical men." They have from time to time experimented, in a half-hearted sort of a way and with an insufficient head of water, and therefore the amount of the large grains that would not come out has often been enough to clog the bit. For the benefit of future experimenters it may be said that the jet will work admirably even in the very softest rocks, when as much as 6 gallons per minute is forced through each jet pipe. In very cold weather these small pipes are likely to freeze, and it takes at least half the time of one man to care for the pump and keep a half-dozen jets going. In moderate weather a small pump can be placed upon the boiler that furnishes the drills with steam and when oiled twice a day will run almost with attention. It should be noted that 6 gallons per minute for each of six jets amounts to over 2,000 gallons of water per hour, which in dry weather might be a heavy strain on the water supply.

One of the standard sets of instructions given by Dana and Saunders is:

Rules for Drill Jets: "In shaly rock of rather soft quality in which, under the jet, a 3¼-in. drill will drive a 3-in. bit 2 in. per min.

"These rules apply to the use of a jet in which the nozzle has a diameter of ⅜ in. and the water pressure is 100 lb. per sq. in.

"As soon*as the drill is wet up and the first bit placed get ready with the jet, start the drill and direct the jet into the hole under the bit as soon as it has cut about 1 in. From this time on keep the jet in the hole with the nozzle of the pipe as near as possible to the working end of the bit.

"Let the nozzle follow the bit down into the hole until you see by the drill stem that the drill has about 5 in. more to go before finishing the cut. Then immediately withdraw the jet and allow the bit to finish this cut. You will have plenty of time after taking out the jet to handle the throttle and wrench. By taking out the jet before the cut is finished there is left enough sludge in the hole to make it very easy to pump the hole clean.

"When the hole has been cleaned, which should be done thoroughly, put in the next bit and start the drill slowly. As soon as the drill has made about five strokes, put the jet in again and keep it there until you are within 5 in. of that cut, and continue in the same way with the succeeding bits. See to it that the

jet follows the bit down into the hole and once or twice for every cut raise it about 2 ft. and push it down again.

"The cost of operating jets is approximately as follows:

1 pump at \$40.00, interest, depreciation and repairs, say,—50%	\$0.13
300 ft. half inch hose, at 10 ct., interest, depreciation and repairs, say, —200%	0.40
Fittings, etc.	0.05
Coal, etc.	0.17
Pipe fitter, $\frac{1}{4}$ day	0.39
Incidentals	0.10

Total per working day for 6 drills \$1.24

"Under normal conditions these jets will increase the output from 30 to 100%, to say nothing of the collateral advantages gained by the use of a smaller main plant. The use of such a method as this which we have here described at some length, sometimes make the difference between a handsome profit and a sickening loss on a contract."

Other Data About the Water Jet. In the *Journal of the South African Institute of Engineers*, September, 1911, Mr. C. J. N. Gordon gives the results of certain experiments in dust prevention by means of a jet of water forced into the hole through a flattened armored garden hose of $\frac{1}{2}$ or $\frac{3}{4}$ -in. diameter. Water was used under a head of 40 to 80 lb. It was necessary, once the jet had been started, to continue using the water jet or the sludge would cake and interfere with the operation of the drill.

Holes 1 and 2 were 8 in. apart in hard quartzite. Air pressure was kept at 60 to 65 lb. Holes 3 and 4 were drilled with two different machines, but in the same rock. As is shown by the data following, the rate in dry holes was 0.33 in. per minute of cutting time, and with the jet the rate was from 0.78 in. to 1.34 in. per cutting-minute. The dry holes required 5 or 6 steels and the wet holes but 3 or 4.

HOLE NO 1 — DRY

	Minutes.	Depth, ins.	Drill marked.
Collaring	4	0	A
Starter No. 2	10	5	B
Starter No. 3	27	7	C
Second cross bit	15	5½	D
Second chisel bit	10	6½	E
Second chisel bit	27	7	F
Total	93	31	

HOLE NO 2 — WET

	Minutes.	Depth, ins.	Drill marked.
Starter No. 1 collared and drilled	9	11	G
Second chisel †	7½	13	H
Third chisel	12	9½	J
Fourth chisel	14	25½	K
Total	42½	59	

† A cross-bit was unfortunately not available.

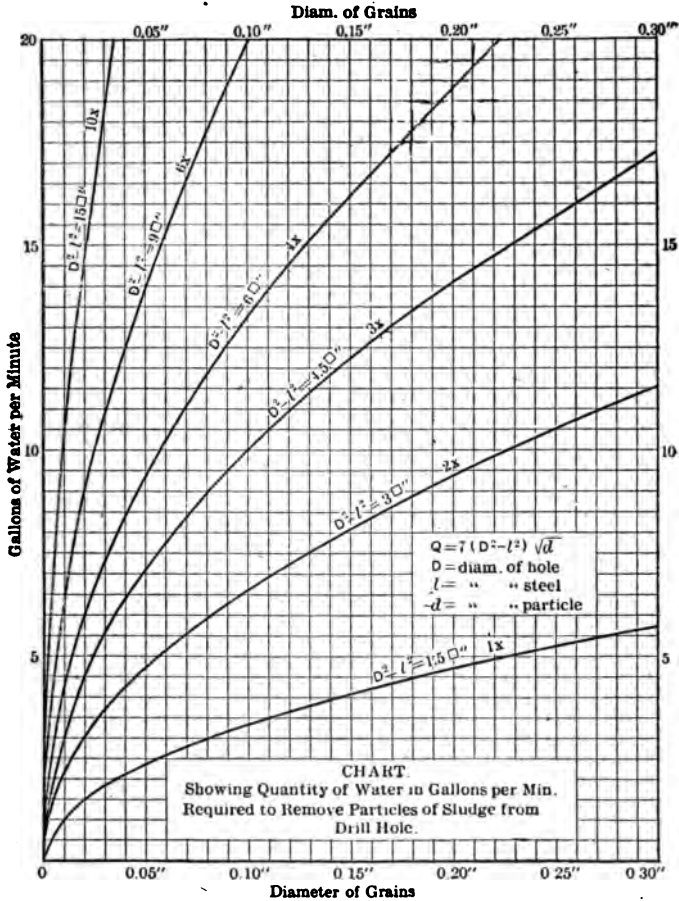

Fig. 32.

Hole No. 3 — DRY

	Minutes.	Depth, ins.	Drill marked.
Collared and started, started hole.....	50	17	L M K N
Second starter	25	6	
Second cross-bit	28	7	
Fourth chisel	18	7	
Fifth chisel	29	11	
Total	150	48	

HOLE NO 4. — WET			
	Minutes.	Depth, ins.	Drill marked.
Collar and starter	32	22	Q
Second diamond	41	28	R
Third chisel	14	18	S
Total	87	68	

Mr. H. P. Stow is authority for the following data (*Mining and Scientific Press*) showing the effectiveness of a water jet in drilling:

“Three rounds were drilled by the same miner, using a 2¼-in. drill, drilling the same number of hours, size, and as near as possible the holes were of the same kind. Two of the rounds were drilled without taking down the bar, and the third was put in alongside of the other two. He drilled one round without water, one with water, bailing from a bucket, the usual method; and the third with water under pressure in a hose. Without water he drilled 32 ft., using 38 drills; with water by bailing, 41¾ ft., using 33 drills; and with water from the hose, 52 ft., using 37 drills—that is, a gain of 30% depth of holes, and 50% gain of feet per drill, with bailing over drilling dry; a gain of 62½% of depth of holes and 67% gain of feet per drill, using the hose over drilling dry; and a gain of 24½% depth of holes, and 11% of feet per drill by using hose over bailing water from a bucket. All of which shows that there is not only a gain of ground drilled, but a saving of drill bits used by using water under pressure, instead of bailing it from a bucket or not using it at all. Besides the actual gain in drilling the ‘pressure-water’ is a saving in getting rid of the gases in the pile of dirt and the dust formed in drilling, resulting materially in the better health of the men, freedom from powder headache and miners’ consumption, and increased rapidity of getting into the face to remove the dirt.”

Combined Water and Air Jet. This is often called “the water attachment,” and, as usually made, consists of a tank holding from 8 to 18 gallons of water under a pressure of from 50 to 100 lbs. per sq. in. Fig. 33 shows the Sullivan “Water Attachment.” This device is formed by boring out the piston, piston rod, and rifle-bar of an ordinary reciprocating rock drill to permit the insertion of a small tube adjusted to the back head of the machine. Water is conducted by a hose line and fittings to the mouth of this tube. Through the tube it passes to the hollow piston rod into which a charge of air under pressure is also conducted. From the piston rod the air and water pass into the hollow drill steel, held in the chuck of the machine which conducts them to the cutting face of the bit. The effect of the combined current of air and water is to eject the cuttings in the form of sludge. The amount of water admitted is controlled by a plug and should

be such as to make a heavy paste of the mud. More water than necessary requires frequent filling of the 18-gallon tank.

The Rix Compressed Air and Drill Company of San Francisco, California, manufacture an outfit with a water tank holding 8 gallons, which is provided with an air pipe through which compressed air enters, forcing the water and air out through a nozzle. This air pipe is attached to the side of the drill cock. The 8 gallons last one or two hours, depending upon how steadily the machine is running. A boy can keep a large number of pots supplied with water. The water does not enter the drill or steel, but is forced into the hole through a slender hollow rod. This rod or nozzle usually is a piece of $\frac{3}{4}$ -in. gas pipe drawn down to a fine point at the end, and it is pushed into the hole as the

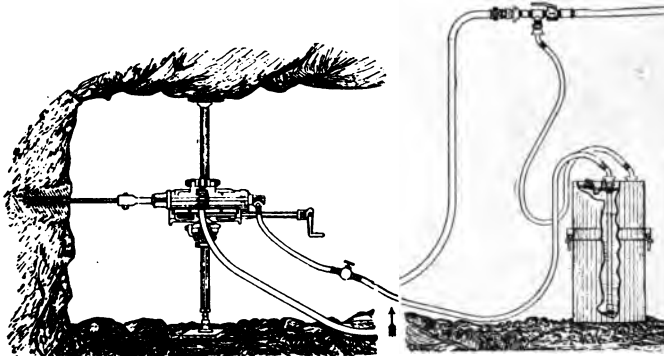

Fig. 33. Sullivan Water Reciprocating Drill, Water Tank and Connections.

drill advances. When running an adit or drift, water can be supplied by gravity from an upper level.

The superintendent of the North Star mine at Grass Valley, Cal., writes the manufacturers: "For clear water, we put up small barrels on each level, or in the most convenient place where there is a drip, and run the clear water into this barrel, which is also protected from dust or dirt. A faucet is placed at the bottom. A boy with a heavy galvanized watering pot, fitted with a small nozzle, distributes the water to the tanks. A tank of water lasts for some time. It depends on how steadily the machine is running and how careful the man is about shutting off the water when not using it. It will last at least an hour or two anyway, and one boy can keep forty tanks supplied under reasonable conditions of water supply."



Fig. 34. Butterfly Drill with Water Spray.

Other drills equipped with solid steels may have an attachment such as is shown in Fig. 28 on a plug drill. This device consists of a blower hose attached at one end to the exhaust opening and at the other end to the drill shank near the point, where it is held in place by a swivel block or rider encircling the bit.

Concrete is exceedingly troublesome material in which to drill deep holes; but water under pressure has been used very effectively with a wide-flare bit which permitted a small copper water pipe to be inserted nearly to the bottom of the hole. The chips and dust were thus carried off by the water before they could wedge the bit, enabling drilling to be done for 25 ct. a ft. at a profit, where previously it had been done at a loss.

The Water Spray. Fig. 34 shows a spray of water forced upon the rock around the drill hole, thus allaying the dust. This spray is a combination of water and air. The attachment shown on an Ingersoll-Rand "Butterfly" rock drill is a device which weighs about 3.5 lb. and is readily attached or detached from a position between the inlet-bushing and hose-connection on a machine. When air is turned on water is drawn from a pail and forced in the form of a spray against the mouth of the hole.

Dust Collectors. Purser's "Dust Arrestor" consists of a short length of piping of such a size at one end that it can be driven into the mouth of the hole formed by the drill. To the other end of the piping is fixed a T-piece with the open end down. At this end is a reducing piece and a small air jet which, acting as an injector, impels the dust into a wet bag or a pipe opening under water. This device consumes a certain amount of air which could otherwise be used in drilling. It is not successful on steeply inclined holes.

Aymard's "Dust Collector" consists of a wet bag with one end over the drill hole mouth and the other end supported by a ring around and sliding upon the drill steel near the chuck. This device is often in the way and retards the drilling, but is otherwise successful.

The Air Jet. When a jet of air unaccompanied by water is forced through a hollow steel drill rod the cut rock is much more mobile and is removed more quickly than is sludge or mud. Furthermore, the hole is always clean and no time need be spent in pumping it. Water injected in a drill hole, however, serves a very useful purpose in allaying the dust, as has been explained previously, and, moreover, preserves the temper of the bit.

In most hammer drills air is employed to clean the hole of cuttings and prevent the bit from sticking. This air is diverted from the inlet passage into the center of the piston or cylinder and thence through the hollow steel to the face of the bit. The air blows out the dust and cuttings. These particles are un-

healthful and in some ores particularly dangerous. In certain districts a water spray is prescribed by law. Such a spray is illustrated by Fig. 34.

The Leyner-Ingersoll Drill. This drill (formerly known as the Water-Leyner Drill), Fig. 35, is of the hammer type and is now made with the "Butterfly" action valve. The drill steel does not reciprocate, but is close to or against the rock at all times, and is struck by the piston, which also rotates the drill bit automatically.

Water under a pressure of from 20 to 150 lb. is required, and may be supplied by a pipe line or from central or individual tanks. The individual tank customarily used is 3 ft. 3 in. high by 12 in. in diameter, weighs about 70 lb., and holds about 17 gallons. Compressed air is admitted to the water tank, forcing the water to the drills. The air admitted to the water tank is not the air which combines with the water and cleans the drill holes. This air comes from the drill. The water passes into the backhead of the drill, through the backhead plug and water tube, into the shank of the drill steel, where air mingles with it and both pass on through the drill steel. The characteristics of this machine are given in Table XI.

A *Comparative Test of Large and Small Leyner Drills* is described by Mr. J. B. Lippincott (*Engineering News*, Apr. 22, 1909), who states that on the Los Angeles Aqueduct Tunnel work No. 9 and No. 7 Leyner Drills were used. The hammer of the large drill had a stroke of 3.5 in., and weighed 7 lb., and struck about 1600 blows per min.

The first test was in medium granite, "which cut nicely and was hard enough not to ravel." Air pressure at the drills was about 90 lb. Both machines were set on the same horizontal bar, and were both run, one after the other, by the same man. Horizontal holes were driven straight into the face. The bits used were as follows:

	No. 9 Drill.	No. 7 Drill.
1st steel	2 $\frac{3}{4}$ in.	1 $\frac{3}{4}$ in.
2nd "	2 $\frac{1}{4}$ "	1 $\frac{9}{16}$ "
3rd "	2 "	1 $\frac{7}{16}$ "
4th "	1 $\frac{1}{2}$ "
Total depth	6 ft. 7 "	6 ft. 11 $\frac{1}{2}$ "

The bit used in the large drill was four-pointed and that used in the small drill was five-pointed. The latter cut the rock more finely than did the four-pointed bit, and thus permitted the water, which was admitted through the $\frac{1}{4}$ -in. hole in the hollow bit, more fully to wash out the cuttings. This is advantageous in the softer rocks. The feed of the large drill was 24 in. and of the small drill 30 in., which gave a certain advantage to the latter as the rock was not hard enough to dull the bit in 30 in.

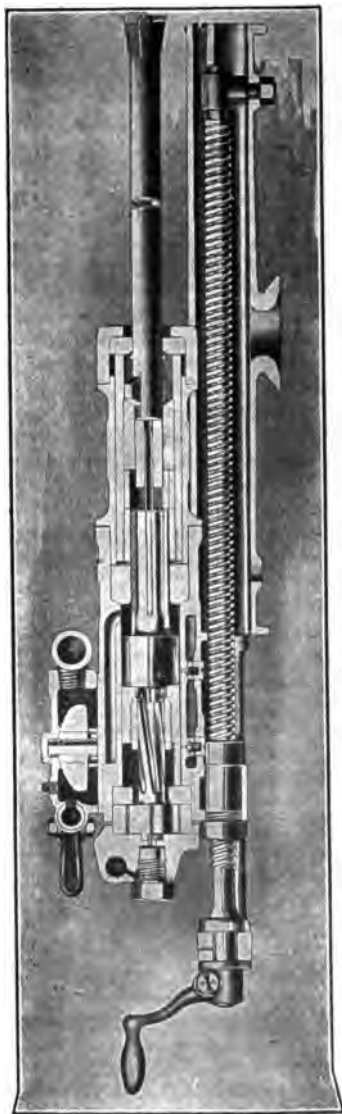

Fig. 35. Sectional View of No. 18 Leyner-Ingersoll Drill.

of drill hole. Both sets of steel were sharpened by the same smith on a Leyner drill sharpening machine.

The second test was in very hard rock, a "bluish live granite." The sizes of bits used in this test were somewhat different, but other conditions were the same as in the first test. As will be seen from the tabulated summary given below, in medium rock the small drill worked 23% faster than the large drill, including time to change steel, and 14% faster during actual drilling time. In hard rock, averaging both runs, the small drill worked 53% faster in total working time.

The small drill was more rapid in actual cutting time and in time of changing steel; it was easier to handle as it weighed 113 lb. against 245 lb. for the large drill; its steels were easier to handle, weighing about one-half as much as those of the large drill; the small holes did not ravel and cause the steel to stick as much; the small drill consumed but two-thirds the amount of air consumed by the large machine; and the small drill cost \$150, while the large one cost \$180.

In hard rock, requiring heavy blasting, larger holes or stronger powder are required and it may be cheaper to use the larger drill and bigger holes.

COMPARATIVE DRILLING TESTS OF NO. 9 AND NO. 7 LEYNER HAMMER DRILLS, LOS ANGELES, AQUEDUCT

*First Test — Tunnel No. 35, Medium Rock.
Large Drill No. 9.*

Diam., In.	Started, min.-sec.	Stopped, min.-sec.	Time chang- ing, sec.
2½	— 0	2-30	30
2¼	3- 0	4-30	45
2	5-15	6-45	45
1½	7-30	9- 0	

Total depth of hole, 6 ft., 7 in.

Total time, including changing steels, 9 min.= 0.75 ft. per min.

Total time, excluding changing steels, 7 min.= 0.94 ft. per min.

Small Drill No. 7

Diam., In.	Started, min.-sec.	Stopped, min.-sec.	Time chang- ing, sec.
1¾	— 0	3-10	35
1½	3-45	5-30	40
1¼	6-10	7-45	..

Total depth of hole, 6 ft., 11½ in.

Total time, including changing steels, 7 min., 45 sec.= 0.90 ft. per min.

Total time, excluding changing steels, 6 min., 30 sec.= 1.07 ft. per min.

Second Test — Tunnel No. 37, Very Hard Rock.

Diam. In.	Time of drilling, min.	Depth drilled, in.
2½	2.5	16
2¼	2.5	14
2½	3.25	15
2¼	3.25	15
2	5.25	27

16.75 7 ft. 3 in.

Note: Including changing steels, 36.25 mins.= 0.20 ft. per min.
Back flat hole. Five steels used.

Small Drill, No. 7, First Run.

Diam., In.	Time of drilling, min.	Depth drilled, in.
1 3/4	5	20
1 1/2	5.5	33
1 1/4	5.5	30
	16	6 ft., 11 in.

Including changing steels, 19.5 min. = 0.41 ft. per min.
 Note: Back flat hole. Steel too dull to drill well after first 15 in. of each steel. Three steels used.

Large Drill, No. 9, Second Run.

Diam., In.	Time of drilling, min.	Depth drilled, in.
2 3/4	2.5	10
2 1/16	3.5	20
2 1/8	4.5	15
2 1/16	5.5	19
2	3.25	32
	19.25	8 ft.

Including changing steels, 29.25 min. = 0.27 ft. per min.
 Note: Down cut hole, 40 degrees from horizontal. Five steels used.

Small Drill, No. 7, Second Run.

Diam., In.	Time of drilling, min.	Depth drilled, in.
1 3/4	7.5	20
1 1/2	4.7	34
1 1/4	3.3	30
	16	7 ft.

Including changing steels 19.5 min. = 0.36 ft. per min.
 Note: Side cut down hole, 20 degrees from horizontal. Changing steels; 1st. 25 sec.; 2nd. 50 sec. Three steels used. Steel too dull to drill well after first 20 in. use of each. Quantity of steel being limited, were obliged to run full length. Air pressure at drill 90 lb. steady.

The Sullivan Mounted Type of Hammer Drill. A small throttle controls the admission of water or air alone or together into the drill steel, and air into the valve and cylinder. By this arrangement a jet of air is admitted to the steel just before closing the throttle, which thoroughly cleans both steel and drill hole. The bit is fitted with a shoulder and is fastened in the chuck by turning the lock with the hand. The valve chest is in the rear end instead of on top or the side of the cylinder. The valve rotation is in direct alignment with the piston. The rotation mechanism is at the front end of the machine and consists of grooves in the piston which engage a retaining bushing in the chuck. Lubrication is automatic. The machine is cranked forward by hand. This drill is designed for drifting and tunneling; it has high drilling speed, is easily handled because of its light weight, is strong and economical in power consumption, and its water attachment eliminates the dust.

The Use of a Collar Pipe in Drilling. Mr. Eustace M. Weston (*Engineering and Mining Journal*, Feb. 22, 1908) gives the following description of methods of preventing fragments of stone

from dropping in a hole and of removing sludge in shaft sinking on the Rand:

Where the ground is shattered by jointings or where drilling has to go on under water so that there is a danger that rock fragments will wash into the holes, collar pipes are driven into the mouth of the hole. These are pieces of old pipe or boiler tube about 12 in. long, having a 3-in. to 3½-in. diameter inside. These help the drilling greatly for the hole "muds" better than when drilling under water, for it can splash when these are used. After the hole is loaded, when it is possible, these pipes are drawn so as to be used again. When the ground is of such a character that the mud tends to settle in the bottom of the hole the hole is pumped out, whenever a drill is changed. For this purpose, pipes, 3 to 12 ft. long and from ¾ to 2-in. diameter are used. They are moved rapidly up and down in the hole, while the hand is used as a valve at the top of the pipe. The pipe is kept closed on the up stroke and the hand is taken away on the more rapid down stroke. This throws the mud and water out. In other places elaborate pumps, made with a plunger and a marble, or other valve, at the bottom, are employed. Ordinary blow-pipes are also used here, but only when coarse grit or rocks in the holes render their use necessary.

A Sludge Agitator, or Air Wash-Out. In slates, shales and other rocks that make sludge rapidly, it is often expedient to keep the sludge in suspension in the "wash water" by air agitation. An air wash-out consists of a ¾-in. pipe connected to a small rubber hose which is connected to a cock that taps the air line of the drill near the air chest. The pipe is lowered nearly to the bottom of the hole, and the air is turned on, agitating the wash-water so that sludge will not accumulate at the bottom of the hole and retard drilling. By means of this device, it is possible to use more wash-water in the hole and yet keep nearly all the sludge in suspension.

Sludge Pump. In drilling deep holes the sludge is removed with a sludge pump, 35A. The hole is bailed out with the pump, by churning it up and down until full of water and sludge, raising it out of the hole and dumping it.



Fig. 35A. Sludge Pump.

Another bailing device consists of a piece of 1½-in. pipe, 2 ft. long, through which passes a long ½-in. steel rod. This rod has a conical piece of metal fastened to its lower end that closes the lower end of the 1½-in. pipe. The rod is made in sections, hooked together, if the hole is very deep.

A "pump steel," by means of which the sludge is constantly being pumped out of the hole by the operation of the drill itself, is used on the Locker traction drill, and is described on page 143, and illustrated in Fig. 37.

A Jammed Drill Extractor. Mr. E. A. Weston gives the following description of a device used for removing jammed drills.

Owing to the use of welded steel, breakage of drills was frequent and holes were repeatedly lost, due to this cause. Nothing is more annoying and disheartening to the operator than to have a 6-in. end break off in a 5-ft. hole that had required, as was frequently the case, three hours' drilling to reach that depth. It was found impossible to devise any really satisfactory tongs or other extractor for regaining these ends. When drills stuck

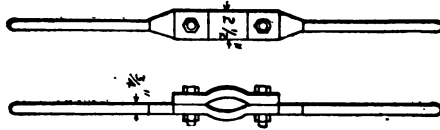

Fig. 35B. Clamp Extractor for Steels.

in holes, owing to bending or other causes, a clamp extractor, Fig. 35B was found very useful.

Auto Traction Rock Drill. This machine was devised by Mr. C. H. Locker in his work on the excavation of the Livingstone Channel on the improvement of the Detroit River. Its principal feature is its ability to drill deep holes without changing steels. It consists (Fig. 36) of a vertical standard carrying a rock drill cylinder attached to a heavy iron block, which is suspended in guides or "leads" over 20 ft. in length by a steel cable that passes over a sheave and is alternately paid out or taken in by a hoisting drum. The standard and hoist are mounted on a steel wagon truck. A two-cylinder reversible engine provides power for the hoist and for moving the outfit from place to place by means of a chain drive to the axle of the rear wheels, above which the standard is mounted. The front wheels swivel to permit steering. The truck carries an air reheater or a boiler as required, and jack screws are provided at the rear end for steadying the machine while drilling is in process.

When used with a 5-in. Ingersoll-Rand H-2 machine with ordinary solid steel in badly seamed limestone and dolomite the following record was made (see *Engineering and Contracting*, Jan. 26, 1910):

On Sept. 23, 1909, drilling 3-in. holes, 29 ft. of hole was drilled in 55 min. This included moving the drill four times, the time



Fig. 36. Auto Traction Rock-Drill Capable of Drilling 5-in. Holes to a Depth of 50 Ft.

occupied in moving being about 45 sec. each. On another day the drill was timed for one hour. Handicapping the drill in this case was dull steel and low air pressure. Yet the first hole was drilled to a depth of 7 ft. 8 in. in $7\frac{1}{2}$ min., the next hole was 6 ft. 6 in. in $26\frac{1}{2}$ min., and at the end of the hour, with five moves, 37 ft. 3 in. of holes had been drilled.

The following is from another observer: In 32 min. it put down three holes, 6 ft. 2 in., 7 ft. 2 in. and 7 ft. 2 in., and was moved three times, leaving it ready for the fourth hole, all in 32 min. In this time there was a delay of 4 min. caused by the driller's neglecting to raise his bar causing it to be bent.

The 6 ft. 2 in. hole in this case from start to finish took $5\frac{1}{4}$ min. The time of moving, that is, from when one hole was finished until another was started, was exactly 2 min.

The performance of this machine is more strikingly expressed, however, by the following statement: Operated by two men, it took the place of the four tripod drills and eight men. Its work compared with the tripod drill was approximately as *five to one*. The amount of air consumed has not been investigated.

For further details of the work of this drill, see column B, Table XIV, page 169.

The work of cleaning the holes is now accomplished by employing special drill steels. These "*pump steels*" consist of ordinary steel, cruciform in section, over which is shrunk a tube the bottom end of which is formed like a cage and contains four $\frac{5}{8}$ in. steel balls which act as valves. When the steel is thrown forward, these balls are raised from their seats by the resistance of the mud in the bottom of the hole, and a quantity of sludge is thrown above them. When the steel lifts, these balls are dropped to their seats preventing the sludge from escaping. The rearward movement of the drill throws the sludge out of the top of the tube. While drilling with this arrangement a good stream of water must be kept running into the hole. After the hole has been drilled to the proper depth the drill is thrown on a cushion provided for this purpose and, reciprocating for nearly full strokes, it pumps out any loose material thus preparing the hole for firing.

Another model of this machine of more substantial construction, equipped with a 14-ft. feed and a Sullivan UM drill, with a piston 7 in. in diameter, capable of drilling holes with a 5-in. bit, was built.

In July, 1910, this machine worked 28 shifts of 8 hr., and put in 3,282 ft. of holes, averaging 11 ft. in depth. This gives an average speed of 117 ft. per shift, of holes 5 in. in diameter, as compared with 39 ft. per shift for $3\frac{1}{4}$ -in. tripod drills, *drilling 3-in. holes as mentioned above*. So that the autotraction

drill actually put in three times as many feet of holes as the tripod machines, and these holes were nearly three times as large in area as those bored by the old type of drill.

The 28 shifts included 31 hr. of lost time, moving away from shots, changing water lines and other delays caused by limited space, low working faces, etc. Seventy-five feet were drilled in 3 hr., 165 ft. in $7\frac{1}{2}$ hr., and 145 ft. per day for 5 consecutive 8-hr. shifts.

It may be noted at this point, to emphasize the economy in time of long runs without changing steel, that a Sullivan $3\frac{5}{8}$ -in. drill, mounted experimentally on a quarry gadder standard, bored 594 ft. of 3-in. hole in 6 days. The length of the gadder standard permitted holes 6 ft. deep to be drilled without change of steel. The machine was new and the men unused to handling it. Both this and the auto traction drill records, mentioned above, were made with the use of the "pump steel."

The following detailed record shows the saving in time accomplished by the use of the "pump steel," and by increasing the length of the feed: On October 26, 1910, two sets of records were taken. The first was made with a Sullivan $3\frac{5}{8}$ -in. drill, mounted on a gadder frame, with a small hoisting engine to raise and lower the steel. The gadder "leads" permitted holes to be drilled 6 ft. deep without changing steel.

Hole No.	Depth, Ft.	Changing Steel Min.	Drilling, Min.	Total Min.
1	8	6	12	18
2	8	5	8½	13½
3	8	3½	9	12½
4	8	4	12	16
5	6	..	10	10
Total	38	18½	51½	70

Six holes were then put in by the same drill, using regular steel, and pumping the holes by hand. The regular feed screw, 2 ft. long, was employed, so that the steel had to be changed once in 24 in.

Hole	Depth Ft.	Drilling, Min.	Total Min.
1	8	14½	42
2	8	24	52
3	8	14	22½
4	8	18½	27½
5	8	13	32
6	6*	42	49
Total	46	126	225

* Bad hole.

The time for moving from hole to hole was not considered in either case. It will be noted that if the length of feed in the

first record had been 8 ft. instead of 6 ft., 18½ min. would have been saved in drilling 38 ft.

It will be seen from these two records that with the "pump steel" and long feed, the rate of drilling was 1 ft. in 1.35 min., but with the regular steel and usual feed (ordinary tripod drill methods) it was 1 ft. in 4.89 min. That is, with the same labor and in the same time the improved method accomplished 3.62 times as much work as the old or standard method.

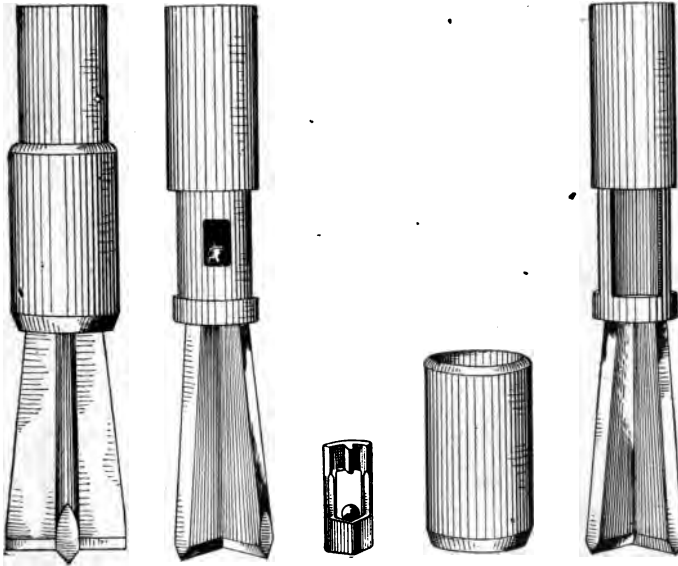

Fig. 37. Pump Steel Used with Traction Drill.

Deep Hole Wagon Drilling Rigs for Heavy Excavation.

Since their early use in the Detroit River channel improvements, wagon drilling rigs have become popular where large areas of rock have had to be drilled for steam shovel excavation. The illustration (Fig. 37A) shows one of these machines used on the Champlain Canal and depicts clearly enough their general features. By means of the turntable mounting, the machine, within location of the track, drills three lines of holes, one midway between rails and one each side of the track; the outside rows are 10 ft. apart. The mobility of this machine gives it a high hole production. On the Champlain Canal drilling 12-ft. 4-in. holes spaced 5 and 10 ft., the footings per shift per machine ranged between 160 ft. and 200 ft. On lock chamber excavation at St. Mary's



Fig. 37A. . Wagon Drilling Rig on Champlain Canal.

Falls four machines drilling holes bottoming $4\frac{1}{4}$ in. and $4\frac{1}{2}$ in. and from 18 ft. to 27 ft. deep, averaged from 58 ft. to 80 ft. per shift. On the Sag Channel of the Chicago Drainage Canal $11\frac{3}{4}$ -ft. $3\frac{1}{2}$ -in. holes were drilled at the rate of 199.1 ft. of hole per 10-hr. day for $2\frac{1}{2}$ years. These data are furnished by the *Ingersoll-Rand Co.*, New York City.

Autotraction Drill Rig and Hollow Piston Drill. Hollow piston drills were used with exceptional success in excavating for the power station at Turners Falls at Montague City, Mass. When the earth on the river bank had been removed, the rock on the level portion was drilled to a depth of 30 ft. and shot for removal by a steam shovel. This work was done with a Sullivan class "FV-14" submarine type rock drill with hollow piston and hollow drill steel, mounted on an autotraction carriage, to facilitate moving from hole to hole. The drill and the carriage engines were operated by compressed air from the central power house. With this machine, 3-in. holes 30 ft. deep were drilled 10 ft. apart, averaging from 150 to 210 ft. per 10-hr. day. The best day's work accomplished was eight 30-ft. holes, the outfit being moved seven times.

The formation consisted of partially disintegrated sandstone, increasing in solidity and hardness with depth until some rock of considerable hardness was encountered in the last few feet of the holes. The rock lay on a pitch of 20 to 30 deg. away from the river, in thin strata. In this formation, the cleaning action secured by the blast of exhaust air, discharged to the face of the bit through the hollow piston and drill steel, was particularly valuable. It prevented the clogging of the bit by accumulated chips and dust, and secured a clean rock face for the bit to strike at all times.

The Brandt Rotary Drill. This is practically the only drill operated by water which has been successful in hard rock. For tunnel work it has proved effective, but is not used for open cut excavation because of the necessity of forcing the bit against the rock which would involve loading it with great weights. Weston, in "Rock Drills," says: "It might be asked, could not some such machine be employed in deep mines where natural heads of water could be obtained, as by this system boring proceeded at as great a rate as with percussive drills? Here certainly the force is applied economically, the jar of percussion is eliminated, water is easily passed down a hollow boring tool, removing broken rock at once, and thus fulfilling one of the ideal conditions desirable. Practical difficulties arise, however. The water used must be free from grit and contain no acid. The machine must be very heavy and mounted in a most rigid manner to withstand the enormous pressure necessary to be applied to the teeth of the boring tool; hence it cannot be made portable to secure easy and rapid change to occupy a new position. The pipe installation in a mine necessary to carry such enormous water pressures would be too costly to install and maintain. In actual work in the hardest rock the efficiency falls off greatly. *There are so many moving parts and connections that time lost in repairs or installing spare machines is a serious item. Rotation might be obtained in a lighter and simpler machine by the*

employment of a turbine or water wheel system, but most of the difficulties mentioned would remain."

A brief description of this machine as used in the Simplon tunnel follows: A small four-wheeled truck carried a horizontal beam, the shorter arm of which supported the horizontal bar on which the drills were mounted, the longer arm being counter-weighted. The bar was braced against the sides of the tunnel by jacks consisting of a cylinder and a plunger operated by water pressure. The drill was rotated by water, acting under pressure in two pistons, from which screw gearing conveyed the motion to the drill rod. The total loss of power by friction was not over 30%. The drill made 5 to 10 rev. per min., according to the nature of the rock. The water required per drill was 240 gal. per min. under a pressure of 1,470 lb. per sq. in. The water was carried through the tunnel in $3\frac{1}{8}$ -in. wrought iron pipes, the friction loss in 3,750 ft. of tunnel being 144 lb. per sq. in.

The drill cut a core, the bit itself being a hollow tube of tough steel, $2\frac{3}{4}$ in. outside diameter, provided with three or four sharp teeth. It chipped or sawed its way into the rock without pulverizing it. The feed was 2 ft. 2 in. long, and when the drill reached the end of the feed it was pulled out, unscrewed, and an extension tube screwed on, the whole operation taking only 15 to 25 sec. The water after passing through the piston, passed down through the drill tube, cooled the bit, and washed out the rock particles. A hydraulic piston advanced the machine and gave a pressure of 10 tons on the bit.

The holes were 4 ft. 7 in. long and $2\frac{3}{4}$ in. in diameter. In gneiss, 3 machines put down 10 to 12 holes in 2.5 hr. or at the rate of 15 or 18 ft. per drill per hr. The weight of the machine was 264 lb. and of the rock-bar full of water 308 lb. The area of the piston for advancing the tool was 15.5 sq. in. which under a pressure of 1,470 lb. per sq. in. gave a pressure of over 10 tons on the tool, while for drawing the tool 2.5 tons were available.

Electric Drills. To obviate the great losses in efficiency and in pipe line transmission resulting from the use of steam or compressed air as power, the rock drill engineer turned to electricity as a convenient and economical source of power. Electricity, however, while particularly adapted to the production of a rotary motion, usually requires the assistance of many gears, cranks, or other transmission parts to generate a percussive action. This leads to many and complicated parts and heavy wear and renewal charges, so, at the present time, the percussive *electric drill is yet in the experimental stage as far as heavy rock work is concerned.*

The advantages of an electric drill as compared with steam

or air drills are: (1) Low first cost of plant; (2) ease of installation; (3) economy of power. The disadvantages are: (1) Very high cost of maintenance; (2) loss of time due to brake-downs. Electric drills have generally been unsuccessful and are used comparatively little.

The Electric Solenoid Drill. The principle of the electric solenoid has been taken advantage of in several drills. The Marvin Sandycraft drill contains a soft steel piston operating in a cylinder each end of which is surrounded by coils of wire. The electric current, passing through a coil, alternately attracts and repels the piston. A spring acts as a buffer to cushion the back stroke and assist the forward blow. Rotation is effected as on standard air drills by riflebar, pawls and ratchetwheel.

Weston, in "Rock Drills," states that the losses of power amount to 6.5 h.p. for 1.5 h.p. exerted in actually cutting rock. The drill is cumbersome and heats very rapidly. Other drills of this type are the Edison and Van Depoele.

Percussive and Hammer Electric Drills. One of the chief sources of high repair cost on this type of electric drill is the heavy jarring which delicate mechanism of the motor undergoes if rigidly connected to the cylinder casing. The Adams electric drill has the motor suspended in a fork which is bolted to the guide shell, and may be placed in various positions as the situation requires. A loose rod running through the armature shaft in the motor transmits the power to gears and a draw bar on the drill which reciprocates the piston. Springs are used to cushion the blow and impart energy on the back stroke to overcome sticking of the bit. Rotation of about 0.05 of a revolution is provided for on the back stroke by means of a special arrangement of ratchets and grooves.

The Gardner electric drill has the motor fastened on the drill. Power is transmitted by a crank shaft and energy is continued throughout the full stroke by a fly wheel on the opposite end of the shaft. This drill is of the hammer type.

The Simens-Schmekert drill has the motor fastened directly to the drill, and power is transmitted through a crank shaft.

The Locke drill has the motor secured to the drill with the crank axle driven by gearing. The proper operation of the piston is secured by helical springs, and the relaxation of the elasticity of these springs would probably cause trouble. Weston says that Locke claims perfect insulation, his drill having been in use 15 months without injury to the insulation. He claims that springs have been in use six months, and that they will stand if not over-compressed. He also states that the power cost is 10% of that of air drills.

The Deitz drill has the motor in a separate case and is connected with the drill by a flexible shaft. This is a hammer drill, an

anvil against the end of the steel being struck by a floating hammer. This hammer is actuated by air compressed in the drill cylinder by another piston, which in turn is driven by gears. The parts are comparatively few in number and there is little shock to the mechanism because of the cushioning effect of the air.

In the Box drill a cylinder surrounding the hammer proper is reciprocated by a small motor mounted directly on the drill and the power is transmitted by means of the air trapped between the ends of the cylinder and piston.

The Dulles-Baldwin drill is a percussive drill. The stroke of the drill is from 5 to 6 in. and speed about 500 strokes per

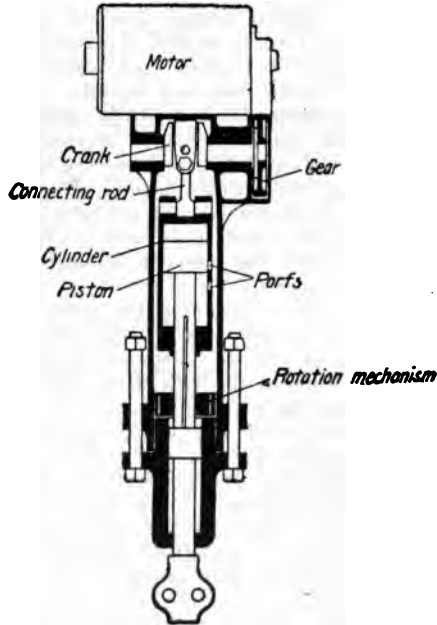

Fig. 38. Section of Dulles-Baldwin Rock Drill.

min. (Fig. 38). The 3 h.p. motor incased in a cast steel housing is bolted to the top of the drill case and is easily removed, the only connection with the inside of the drill being the meshing of the gears.

The transmission from motor to drill is by gearing from the armature shaft to a crank shaft at the top of the drill. The crank through a short connecting rod gives a reciprocating motion

case. A piston and rod, at the end of which is a chuck for holding the steel, moves in the cylinder, the movements being cushioned by the compression of the air between the piston and the ends of the cylinder. There are two ports in the side of the cylinder, one of which admits air back of the piston, the other allowing air to escape ahead of it until closed by the piston itself. These ports then control the amount of compression and consequently the length of stroke. The piston rod is slotted spirally to engage with a rotation mechanism at the drill head.

The length of the stroke of the cylinder is 3 in. The longer stroke of the piston is due to the expansion of the air back of the piston, the momentum causing its motion to continue after the cylinder stroke is completed.

The moving parts of the drill are encased in a cast steel shell and the whole rests on a guide shell and is operated by a feed screw and crank.

The Fort Wayne drill is of the rotary hammer design operated by an electric motor which is mounted on the frame of the drill proper. The mechanism of the drill consists of two parts, a revolving helve containing the hammers, and the chuck mechanism for holding the rotating drill steel. A flexible belt connection between the motor and drill permits a variation of speed to any degree desired.

The striking mechanism is a revolving helve within which are two chambers, in each of which a hammer consisting of a solid block of special steel floats freely. As the helve revolves, the hammer is thrown outward by centrifugal force and at each revolution strikes a blow upon the projecting head of the drill steel cap, which delivers the energy of the blow to the drill steel. After delivering the blow the hammer rebounds into the chamber within the helve, where it is completely cushioned upon the air which it traps.

The rotation of the drill steel is effected by means of a heavy worm gear reduction driven from the helve shaft. A slip friction cone is mounted on the worm gear shaft and serves to protect the gears from undue strain in case of sudden sticking of the drill steel.

The Electric Air Pulsator Drill. This drill (Figs. 39 and 40) consists of two separate machines.

(1) The drill, which is of a very simple type,—a cylinder containing a moving piston and rotation device, with no valves, chest, buffers, springs, side rods or pawls. The cylinder is large but the piston is shorter than in the usual type of air drills. This drill is connected by two lengths of hose to the compressor or pulsator.

(2) *The pulsator is a vertical duplex, single-acting air compressor with opposite cranks. It is geared to a motor operated*

by either direct or alternating current. The drill takes a large cylinder full of air at a low pressure and expands it on the return stroke through a hose line into the pulsator cylinder where it is applied on one pulsator piston to help drive the other pulsator piston forward.

The maximum gage pressure attained is moderate but the net pressure is high because of the difference between the compression and expansion pressures on each side of the drill piston and because of the larger piston diameter. The pressure is withdrawn in front of the piston, thus giving a heavy blow. This drill may be mounted any way that the ordinary drill can be mounted. The pulsator is usually mounted on wheels resting on track but may be carried on a carriage or similar device.

In this type of drill the delicate mechanism of the motor is not subject to the tremendous vibration that is unavoidable in the ordinary type of electric drill. Neither is the liability so great of having motor troubles due to short circuits caused by water or dirt penetrating the motor. The chief source of trouble is in the air lines, for these must be absolutely tight, as the machine takes in very little new air, simply driving the air contained in its chambers and passages, back and forth.

The 5-C electric-air drill may be regarded as the full equivalent



Fig. 39. Electric-Air Pulsator.

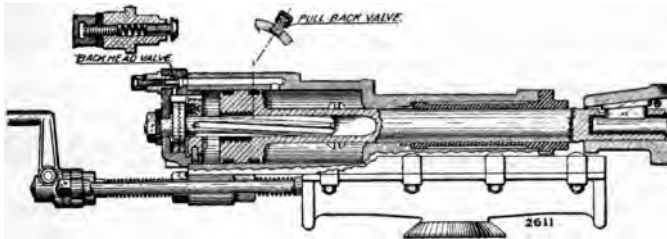

Fig. 40. Drill Cylinder of Electric-Air Drill.

of the 3.25-in. standard air drill of any make. The power requirement for this drill is from 18 to 20 amperes at 220 volts, or from 9 to 10 amperes at 440 volts—the electrical equivalent of about 5 h.p. The system being a closed circuit, this is independent of conditions of altitude, which make so much difference with the work of the air compressor which supplies the ordinary air drill. The 4-C electric-air drill uses a 3-hp. motor, and is a much lighter drill throughout, equivalent to a 2.75-in. standard air drill. This drill, known as the Temple-Ingersoll drill, is made by the Ingersoll-Rand Drill Co. The weight of the 5-C drill complete with pulsator but without tripod is about 1100 lb., and its price is \$1050. The weight of the 4-C drill complete is 700 lb. and its price is \$1000.

Gasoline Air Drill. The manufacturers of the electric operated pulsator air drill have recently placed upon the market a similarly constructed and operated drill in which a gasoline motor is substituted for the electric motor as a power generator. The fuel consumption is about 2 quarts of gasoline per hr. or 3 or 4 gal. per working day.

Pneumelectric Drill. The essential features of this drill are shown in Fig. 41, to which the letter designations in the subsequent description refer:

The drill is an electrically operated hammer drill. The power directly supplied to the hammer or drilling part is not electric, however, but compressed air. The drill is essentially an air drill, the electric motor operating a compressor piston and the compressed air actuating the hammer.

Considerable trouble was experienced with the motors on account of dripping water entering the casing and burning out the armatures. This trouble was eliminated when alternating current was substituted and induction motors used, but some trouble was experienced by the burning out of connections and the overheating of motors due to low voltage on account of too small leads from the transformers. These troubles necessitated chang-

ing an average of one or two out of seven motors on a shift. These troubles might have been eliminated by use of heavier leads and a waterproof wire connection at the motor.

The motor with 220 volt current is rated at $2\frac{1}{2}$ h.p., but the power actually developed is greater. The electrical power input as metered on several drills on vertical holes was 3 k.w., or about 4 hp. Assuming a motor or efficiency of 80% the developed hp. was 3.2.

The motor *A* is attached to the drill on a slide and held firmly to the gear case *B* by two side rods. It is mounted with its rotating shaft in the direction of the drill and connected to the gears by shaft *C*. The motor shaft slides into the end of shaft *C* and outside teeth on the motor shaft mesh with the inside teeth of shaft *C*. The principal parts of the drill are: gear case *B*; cylinder *D*; pawl shaft *H*; pawls and ratchet *I*; and valves, ports, etc., described in detail below.

The gear case contains the necessary gears for transforming the rotary motion of the motor into the reciprocating motion of the piston and to rotate the pawl shaft which rotates the chuck and drill steel. All gears are set in ball bearings. Shaft *C* transmits the power of the motor to the large gear wheel *M* by beveled gears.

On the up stroke the piston compresses the air and draws the hammer up with it by vacuum. At the end of the stroke the compressed air throws the hammer down against the dolly block resting against the drill steel and the piston follows down to repeat. In the figure, the piston and hammer are shown about to start the up stroke. Air has entered the cylinder back of the piston through an inlet valve and port *M*. Ports *M* and *N* are connected through the cylinder walls. The piston now moves to the upper end of the cylinder compressing air until it passes ports *N* when compressed air passes around the piston from *M* to *N* and throws the hammer down. There is then open between the hammer and piston an outlet valve which exhausts the compressed air on the down stroke of the piston.

The shaft of the larger gear wheel *J* connects by beveled gears and intermediate shaft to the pawl shaft *H*, which operates on moving pawl and ratchet *I*, turning chuck and steel after each blow of the hammer. One holding pawl at the bottom holds the chuck while the moving pawl releases to engage the next tooth.

Water connection is made at the side of the drill just back of the chuck. The water is led into a rubber collar *P* around the dolly block and into the dolly block. From the dolly block the water passes through the steel, the point of drill and washes the

cuttings out of the hole. The pneumelectric drill is made by the Ingersoll-Rand Drill Co.

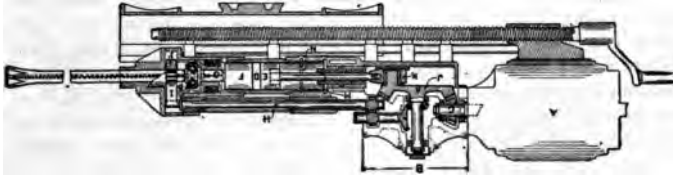

Fig. 41. Section Showing Details of Pneumelectric Rock Drill.

Gasoline Rock Drill. The gasoline driven machine devised by Scott operates on the "hammer" principle. The drill steel is not reciprocated but is constantly in contact with the rock while being struck with the reciprocating hammer; it is automatically rotated a small amount and then struck again. The advantages claimed for this type of drill, as compared with the steam or air drill, are the portable feature, low cost of installation, small up-keep, elimination of pipe lines, lack of vibration, and low fuel cost. See Figs. 42 and 43.

The engine is a single cylinder "two cycle" water-cooled machine. On the up-stroke of the piston, Fig. 42 (7), gas is drawn into the receiving chamber (3) through the mixing valve and by-pass (44). An explosion occurs in chamber (2) on every down-stroke, driving the pistons downward and storing energy in the fly wheel for the return stroke. On the down-stroke the exhaust port (39) is opened by piston (7), and the charge in the receiving chamber (3) is compressed to 9 lb. pressure and transferred to the explosion chamber (2) through valve (37). The next up-stroke of the piston compresses the charge in the explosion chamber (2) and draws a new charge in the receiving chamber (3). At the terminus of the up-stroke the charge in the explosion chamber is ignited by a spark arrangement commonly used on gasoline engines.

There are two pistons, one mounted within the other. The inner piston (25) has a fixed stroke and is connected to the crank shaft through the connecting rod (28) and piston pin (27). The outer piston is a floating hammer and has no mechanical connection with other parts. An explosion of 300 lb. pressure occurs in the explosion chamber on every out-stroke, driving the two pistons forward (the pistons being in the positions as shown in Fig. 42 at the time the explosion occurs), the hammer piston striking the "hammer block" (9) (which is in contact with the

shank of the drill steel), comes to a stop before the crank has reached its dead center. The energy stored in the fly wheel causes the inner piston to continue to move forward independent of the floating hammer piston; the piston pin (27) moving down the oblong slots (33), cut in the hammer piston. During this forward independent movement of the inner piston, the crank shaft passes easily over dead center without any shock to the bearings; the inner piston uncovers the air ports (36), cut in the wall of the hammer piston, so that air at atmospheric pressure enters the chamber (45) between the two pistons. As the inner piston starts rearward (caused by the momentum of the fly wheel), the air in this chamber (45) is compressed until the hammer piston moves rearward with the inner piston. With good ventilation the exhaust is not noticeable or injurious.

Drill C-7 — Capacity, 8 to 10 ft. hole; 2 h. p.; weight 150 lb.

Drill C-4 — Capacity, 4 to 5 ft. hole; 1 h. p.; weight 90 lb.

The mounting is not included in the weight. The C-4 machine can be used as a hand drill with very slight changes. Two types of steel are used; common hollow steel with which a jet may be used or a solid steel with a spiral conveyor for removing the cuttings out of the hole as the steel is rotated. The steel is held by a common U-bolt and fed by an ordinary feed screw.

Fig. 42 illustrates this machine and the figures thereon refer to the following parts:

- | | |
|---------------------------------|-------------------------|
| 1. Cylinder. | 28. Connecting Rod. |
| 5. Front Head. | 29. Journal Bushing. |
| 6. Chuck. | 30. Buffer Pin. |
| 7. Hammer Piston. | 31. Buffer Stud. |
| 8. Hammer Head. | 32. Fly Wheel. |
| 9. Striking Block. | 35. Timer Insulator. |
| 12. Worm Wheel. | 37. Inlet Valve. |
| 13. Worm. | 38. Inlet Valve Spring. |
| 14. Rotation Shaft. | 41. Crank Pin Bearing. |
| 15. Crank Shaft Sprocket. | 42. Cross Head. |
| 16. Crank Shaft. | 43. Cross Head Nut. |
| 17. Rotator Shaft Sprocket. | 46. Crank Pin Nut. |
| 18. Rotator Chain. | 47. Valve Cage. |
| 19. Buffer Spring. | 48. Rotator Nut. |
| 20. 1st Buffer Plate. | 49. Piston Pin Bearing. |
| 21. 2d Buffer Plate. | 50. Cage Stud. |
| 22. 3d Buffer Plate. | 51. Rotator Bearing. |
| 24. Bushing for Striking Block. | 52. Rotator Bearing. |
| 25. Inner Piston. | 53. Timer Spring. |
| 26. Valve Nut. | 55. Piston Ring. |
| 27. Piston Pin. | 56. Side Plate. |

Two types (C-7 and C-4) are now being manufactured. Type

C-7 is illustrated in Fig. 43 in position for drifting work. Both machines are equipped with magnetos contained in the fly wheels.

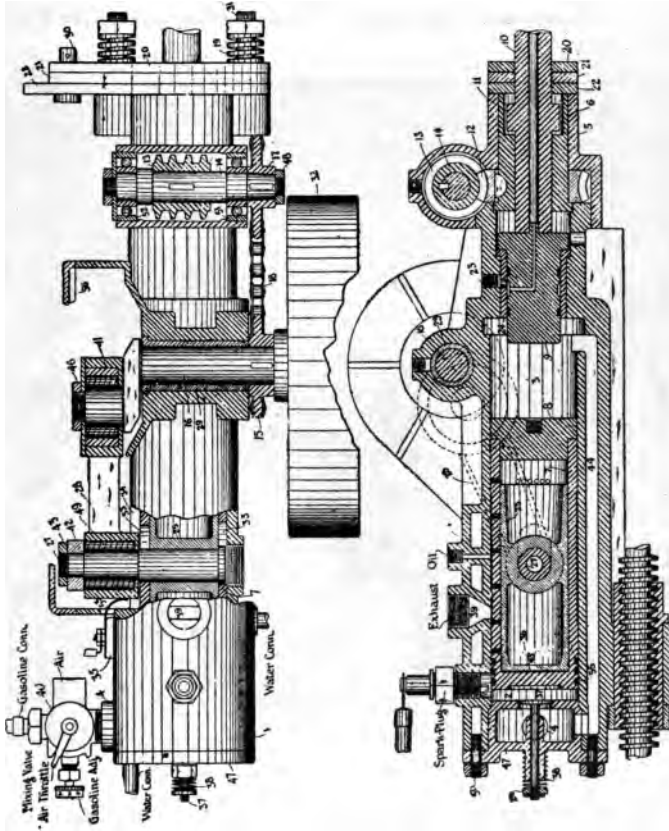

Fig. 42. Scott Gasoline Drill Sectional View.

It is only lately that these machines have been manufactured for the market and the only records of performance obtainable are those made in special tests with the earlier models. These tests were in hard flinty Missouri limestone. The tests showed that the average gasoline consumption in one day's run of 8 to 10 hr. was 2 gallons of gasoline and lubricating oil mixed in the proportions of a quart of the latter to 5 gallons of the former for

the large C-7 drill. The average drilling speed per hour of actually cutting was 17 ft. The maximum speed was 27 ft. per hr. This time does not include the time required to change bits, shift machines, etc. The holes in the above test were from 8 to 14 ft. deep.



Fig. 43. Scott Drill (C-7) on Drifting Work.

Rice Gasoline Rock Drill. This is a percussive drill (Fig. 44), the pistons, piston rod and bit forming one free acting, floating piece. The piston rod and pistons form one moving part, the rifle nut another moving part, and two make and break the spark. The engine is two-cycle and is water-cooled. The principal characteristics of the drill are as follows:

Type	B
Diameter of cylinder, in.	3 1/4
Length of stroke, in.	5
Length of drill, in.	48

	B
Feed, in.	24
Strokes per minute	600
Depth of holes drilled, ft.	1 to 24
Diameter of holes drilled, in.	1 1/8 to 2 3/4
Weight of drill, unmounted, lb.	310

The drill consumes about 3 gallons of gasoline per day.

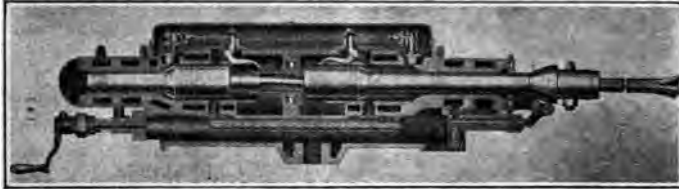

Fig. 44. Rice Gasoline Rock Drill.

CHAPTER V

COST OF MACHINE DRILLING

Cost Factors. The items that go to make up the cost of power drilling are:

1. Wages of driller and helper.
2. Proportionate part of wages of power plant crew.
3. Fuel.
4. Sharpening drills, including transportation to and from shop.
5. Repairs and renewals of parts.
6. Interest and depreciation of plant and other fixed charges, such as taxes and insurance distributed over the shifts actually worked.
7. Water and oil.
8. Proportionate part of general expenses, such as salaries of superintendent, office employees, rent, etc.
9. Installation of plant, including freight, hauling, setting up, dismantling, etc.
10. Preparatory clearing of drilling site.

I have enumerated these items because it is a common error to overlook one or more of them; and for the same reason I will now give the factors that determine the number of feet of hole drilled per shift:

1. Character of rock, including resistance to drill cutting, presence of seams, rapidity of formation of sludge or dust.
2. The percentage of time required to change bits, to shift the drill and set up; convenience of arrangements for changing bits.
3. The depth of hole.
4. The direction of the hole, up, down or horizontal.
5. The size of bits.
6. The form, sharpness and toughness of bits.
7. The use of water poured in the hole.
8. The use of water jets.
9. The use of a hollow bit with water or air jets, or of special bits for removing sludge.
10. The percentage of time lost in blasting, preparing the drill site, breakdowns, sticking of bits, etc.
11. *The kind of power directly applied: steam, air, electricity, etc.*

12. The pressure of the air or steam at the drill.
13. The diameter and stroke of the drill piston.
14. The type of the drill.
15. The mounting of the drill.
16. The kind of weather.

Other factors affecting the cost and the speed of drilling are the nature of the drill steel, the skill of the blacksmith, the weight of the moving parts of the drill, the cut-off in the steam chest and the diameter and the length of the pipe connection, etc.

In publishing records of drilling costs, it is desirable that the most influential of these factors should be given, yet it is rarely that many of them are recorded. It has been the custom to state merely the kind of rock, the name of the drill, and the cost in cents per foot of hole drilled, without any statement as to rates of wages, price of fuel, or in fact any of the data needed to form an intelligent estimate of the applicability of the information to other work.

Percentage of Time Lost in Percussive Drilling. In operating machines of any kind the percentage of lost time is a factor that should receive the most careful consideration. Notwithstanding the self-evidence of this fact, when writing the first edition of this book I looked in vain for published records showing the average time lost in setting up, changing bits, cleaning hole, etc. Fearing that my own records of these extremely important items might not cover a sufficiently wide range of conditions, I prepared blanks which I sent to a number of contractors and mine managers. I was not surprised to receive some answers to the effect that conditions were so variable as to make such records of no practical value. Now, it was precisely for the purpose of determining the range of conditions that these blanks were sent out. Indeed, no perfect picture of conditions can be given except by the filling in of just such blanks. They tell at a glance whether the rock was easy to drill or hard; whether the sludge cushioned the blow of the bit or not; whether the drill crew was lazy or not, and, in a word, just what the conditions of operation were, so far as drilling was concerned.

The most serious loss of time in percussive machine drilling is the time lost in changing bits and pumping out the hole; for, with a 2-ft. feed screw (which is the ordinary length), a new drill must be inserted for every 2 ft. of hole drilled. It takes from 4 to 16 min., to drill 2 ft. of hole, counting the actual time that the drill is striking, and it ordinarily takes from 2 to 10 min. to change bits and pump out the hole. I have often timed work where 9 min. were spent in drilling, followed by 9 min. lost in changing bits. Counting no other time losses, then, *half the available time was lost in the operation of changing bits.* From

the written reports that I have received, I am certain that few mining men and fewer contractors have ever given this phase of drilling any consideration at all, although, in my judgment, it is often the cause of a loss where there should be a profit. In all the literature on the subject of drilling, until recently, I have been able to find only slight mention of the importance of timing drilling operations with the minute hand of the watch.

Where holes are drilled to a depth of 10 ft. or more, the drill steel becomes so heavy that change of bit is an operation usually requiring 3 min. When done properly, the driller starts to raise the drill with the feed screw and at the same instant the drill helper begins to loosen the chuck with his wrench. Without any great effort these two operations are finished at the same time, requiring about 1 min. The pumping out of the hole with the sludge pump can be done by the drill helper in 1 min., or less, but I have frequently seen deliberate workers take 2 min. or more. The drill helper then puts a new drill into the hole and enters its shank in the chuck; as soon as this is done the driller should begin to feed the drill forward, and the drill helper should at once tighten the chuck; these operations taking 1 to 1½ min. After the first few blows are struck, it is often necessary to tighten the chuck again, consuming ½ to ¾ min., but this can be obviated by using good chuck bolts and by training the men properly.

Square bolts are better than hexagonal bolts because the wrench does not slip off as easily. The three necessary operations (removing bit, pumping, and putting in new bit) can be done with ease in 3 to 3½ min. If, however, the drill helper waits till the driller has raised the drill steel before he begins loosening the chuck, another minute may be unnecessarily added to the time; and, in a similar manner, by deliberation (which is equivalent to laziness) the two men may while away 6 min. or more unnecessarily. When shallow holes (6 ft. or less) are to be drilled, the drill steel is light and there is often little or no sludge pumping to be done. In such cases it is possible for the driller and his helper to change bits in 1 min., or even less when they are rushing the work. So far as the changing of bits is concerned the men should be made to work with a vim. When men have to exercise their muscles incessantly for 8 or 10 hr. there is reason in taking a slow, steady gait, but in machine work, muscular exercise is intermittent and should be vigorous.

In drilling shallow holes it is especially desirable to reduce the lost time as much as possible. To save time in changing drill bits one authority recommends riveting the two nuts on the U-bolts. *Cut a key seat in the upper end, and insert a wedge having a small lug. Put in this wedge with the tapering side toward the*

end of the chuck so that every blow of drill tends to tighten it. Two blows of a hammer will loosen the wedge so that the drill can be removed.

Dana and Saunders give, as the average of 62 observations on different jobs, 3 min. 34 sec. time consumed in changing bits where the sludge was not pumped out; the best record was 40 sec., and the worst was 9 min. 30 sec. Where the sludge was pumped out the average of 71 observations on changing bits and bailing the sludge was 5 min. 13 sec.; the best record was 1 min. 35 sec., and the most was 14 min. 5 sec.

A fairly typical average time for each of the various operations is given in the first column below, and a minimum time is given in the second column:

	Average	Minimum
Raising drill	0 min., 46 sec.	0 min., 15 sec.
Loosening chuck	0 " 11 "	0 " 5 "
Removing bit	0 " 48 "	0 " 5 "
Getting bailer	0 " 20 "	0 " 10 "
Bailing hole	1 " 0 "	0 " 30 "
Putting bit in hole	0 " 20 "	0 " 5 "
Inserting bit in chuck	0 " 20 "	0 " 10 "
Tightening chuck	0 " 17 "	0 " 10 "
Gettting started	0 " 7 "	0 " 5 "
Total	4 " 9 "	1 " 35 "

Next in importance to the time lost in changing bits is the time lost in shifting the machine from hole to hole. This, again, is a factor slightly touched upon by writers, in spite of its importance, especially in drilling shallow holes. To move a tripod from one hole to the next and set up again ready to drill, seldom consumes less than 7 min., even when the two men are working rapidly, when the distance to move is short, and when the rock floor is level and soft. When, however, the rock floor is irregular and hard, requiring the vigorous use of gad and pick, not only in making holes for the tripod leg points to rest in, but requiring, also, some little time in squaring up a face for the bit to strike upon, the two men may consume from 30 to 60 min. shifting the machine and setting up, if they work deliberately. In such cases it is advisable to have common laborers working ahead of the drillers preparing the face of the rock, leveling the site of the hole, removing loose rock, etc. One can see clearly what a great saving in time may thereby be effected; yet, this simple expedient is seldom adopted; but the driller and his helper are usually left to themselves in preparing the ground for each new set up. I repeat again that every foreman and manager of rock excavation should use the minute hand of his watch frequently (and at times when he is not observed), to determine exactly how much time his men are losing in changing bits and

shifting. He will thus learn where his employer's money is being wasted.

Where drillers are obliged to move long lengths of air or steam pipe before blasting, or where narrow trenching makes it difficult to shift the drill and causes material delay in advancing the steam pipe line, there are obviously other sources of delay which should be ascertained by careful timing, with a view to reducing the delay by some additional expenditure of money if found advisable.

In seamy or soft rock where the bit sticks frequently in the hole the time lost from this cause alone may be 30%.

Excluding the time required to change bits for the new hole, we may say that two men can ordinarily make a new set up with a tripod in 12 to 15 min., if they work rapidly.

When the drill is mounted on a column or bar, the time required to set up the column and get ready to drill ranges from 10 min. (when the men are racing) up to 60 min. (when the men are loafing). Men working deliberately ordinarily take about 25 min. From one set up of a column, however, 6 to 12 holes may be drilled, by shifting the drill along the column. The shifting itself need not take more than 1 to 2 min., but the time required in addition for changing bits and cleaning the hole will not differ materially from the time above given for tripod work.

Tables XII and XIII give typical examples of actual work in different kinds of rock and in different parts of the United States. Part of the data was taken from my own notes, but I wish here to express my thanks for most of the data to the following mining and civil engineers: Mr. B. B. Lawrence, Mining Engineer; Mr. E. C. Means, Mining Engineer; Mr. Alex. Veitch, Mining Engineer; Mr. R. Gilman Brown, Mining Engineer; Mr. T. H. Loomis, Civil Engineer; Mr. Walter Seeley, Civil Engineer.

TABLE XII. AVERAGE TIME DRILLING VERTICAL HOLES
(Drill mounted on a tripod.)

	A	B	C	D	E
	Lm.	S.	Gr.	Sd.	Tr.
Kind of rock					
Drilling first 2 ft., min.	9	10½	12	8	14
Cranking out and removing bit, min. ...	1	3½	1	1½	1½
Cleaning out hole, min.	3	1	1½	1½
Putting in new bit and cranking back, min.	1	2½	1½	1	1½
Drilling second 2 ft., min.	13	10½	14
Drilling last 2 ft., min.	12	10½	11	6	..
Moving machine from hole to hole and setting up	15	35	..	12	36
Air pressure, lb. per sq. in.	70	(?)	80	70	70
Diameter of drill cylinders, in.	3¼	3¼	3¼	3¼	3¼
Diameter of starting bit, in.	2½	2½	3½	2	2½
Diameter of finishing bit, in.	1¾	1½	1½	1½	2
Depth of hole, ft.	12	6	20	12	6
Length of shift, hr.	10	10	10	10	10
Ft. drilled per shift	48	96	36

Note: The kind of rock designated by the abbreviations is as follows:
Lm., limestone; S., sandstone (hard); Gr., granite; Sd., sandstone (soft);
Tr., *trun* (diabase).

TABLE XIII. AVERAGE TIME DRILLING HOLES IN A BREAST

(Drill mounted on a column.)

	F	G	H	I	J	K	L
Kind of rock	Sp.	Sd.	Lm.	Gr.	Py.	Py.	Sl.
Drilling first 2 ft., min.	20	10	5	10	5 1/4	3 1/2	24
Cranking out and removing bit, min.	2	3	3/4	3	1/2	1/2	2
Cleaning out hole, min.	2	3	0	3	0	0	0
Putting in new bit and cranking back, min.	1	2 1/2	1	4	3/4	1 1/2	2
Drilling second 2 ft., min.	15	9	6	10	19	4 3/4	30
Drilling last 2 ft., min.	15	9	8	10	30
Shifting machine on column, hole to hole, min.	5	7	8	3 1/2	5	5	10
Shifting column, and setting up, min.	20 to 60	25	25	18	31	30	40
Air pressure, lb. per sq. in.	75	75	80	100	75	75	70
Diameter of drill cylinder	3 1/4	3 1/4	3 1/4	3 1/2	2	2 1/4	3 1/2
Diameter of starting bit	2 3/4	2 1/2	2 1/2	2	1 3/8	1 1/2	2 1/4
Diameter of finishing bit	2	1 1/2	1 3/4	1 1/2	1	1 1/4	1 1/2
Depth of hole	8	12	12	6	4.6	5.5	5.5
No. of holes drilled at one column set up	9	10	12	10	7	8	7
Length of shift, hr.	10	10	10	8	8	8	10
Time lost at blasting, hr.	1	1 1/2	(?)	1/2	2	1	(?)
Time lost mucking and timbering, hr.	4	(?)	(?)	(?)
Ft. drilled per shift	60	31	38	25

Note: The kind of rock designated by the abbreviations is as follows: Sp., soapstone; Sd., sandstone; Lm., limestone; Gr., granite; Py., quartz porphyry (soft in column J; hard in K); Sl., slate. Column J applies to Rand drills using chisel bits; column K to Leyner-Water drills using X bits in a softer rock.

Rates of drilling in Different Rocks. Unfortunately few published records exist showing rates of drilling in different kinds of rock with given air or steam pressures and given sizes of drill bits. Such scattering records as are to be found merely give the feet of hole drilled per shift. Tables XII and XIII give a fair idea of the speed of actual drilling, and from them together with other data obtained by observation I have compiled the following table for drilling with 3 1/8-in. machines using air or steam at 70 lb. pressure, starting bit about 2 3/4 in. and finishing bit about 1 1/2 in.:

	Time to drill 1 ft.
Soft sandstones, limestones, etc.	3 min.
Medium, ditto	4 "
Hard granites, hard sandstones, etc.	5 "
Very hard traps, granites, etc.	6 to 8 "
Soft rocks that sludge rapidly	8 to 10 "

The foregoing data apply only to drilling where no time is lost by the sticking of the bit in the hole, and only with air pressure and bits approximately as above given, and where water jets were not used.

The reader should now read the text on pages 214 to 217, noting especially the falling off in the rate of drilling accompanying decreased air pressure. He should also study the table

shifting. He will thus learn where his employer's money is being wasted.

Where drillers are obliged to move long lengths of air or steam pipe before blasting, or where narrow trenching makes it difficult to shift the drill and causes material delay in advancing the steam pipe line, there are obviously other sources of delay which should be ascertained by careful timing, with a view to reducing the delay by some additional expenditure of money if found advisable.

In seamy or soft rock where the bit sticks frequently in the hole the time lost from this cause alone may be 30%.

Excluding the time required to change bits for the new hole, we may say that two men can ordinarily make a new set up with a tripod in 12 to 15 min., if they work rapidly.

When the drill is mounted on a column or bar, the time required to set up the column and get ready to drill ranges from 10 min. (when the men are racing) up to 60 min. (when the men are loafing). Men working deliberately ordinarily take about 25 min. From one set up of a column, however, 6 to 12 holes may be drilled, by shifting the drill along the column. The shifting itself need not take more than 1 to 2 min., but the time required in addition for changing bits and cleaning the hole will not differ materially from the time above given for tripod work.

Tables XII and XIII give typical examples of actual work in different kinds of rock and in different parts of the United States. Part of the data was taken from my own notes, but I wish here to express my thanks for most of the data to the following mining and civil engineers: Mr. B. B. Lawrence, Mining Engineer; Mr. E. C. Means, Mining Engineer; Mr. Alex. Veitch, Mining Engineer; Mr. R. Gilman Brown, Mining Engineer; Mr. T. H. Loomis, Civil Engineer; Mr. Walter Seeley, Civil Engineer.

TABLE XII. AVERAGE TIME DRILLING VERTICAL HOLES
(Drill mounted on a tripod.)

	A	B	C	D	E
	Lm.	S.	Gr.	Sd.	Tr.
Kind of rock					
Drilling first 2 ft., min.	9	10½	12	8	14
Cranking out and removing bit, min.	1	3½	1	1¼	1½
Cleaning out hole, min.	3	1	1¼	1½
Putting in new bit and cranking back, min.	1	2½	1½	1	1½
Drilling second 2 ft., min.	13	10½	14
Drilling last 2 ft., min.	12	10½	11	6	..
Moving machine from hole to hole and setting up	15	35	..	12	36
Air pressure, lb. per sq. in.	70	(?)	80	70	70
Diameter of drill cylinders, in.	3¼	3¼	3¼	3¼	3¼
Diameter of starting bit, in.	2½	2½	3½	2	2½
Diameter of finishing bit, in.	1¾	1½	1¼	1¼	2
Depth of hole, ft.	12	6	20	12	6
Length of shift, hr.	10	10	10	10	10
Ft. drilled per shift	48	96	36

Note: The kind of rock designated by the abbreviations is as follows:
Lm., limestone; S., sandstone (hard); Gr., granite; Sd., sandstone (soft);
Tr., trap (diabase).

TABLE XIII. AVERAGE TIME DRILLING HOLES IN A BREAST

(Drill mounted on a column.)

	F	G	H	I	J	K	L
Kind of rock	Sp.	Sd.	Lm.	Gr.	Py.	Py.	Sl.
Drilling first 2 ft., min.	20	10	5	10	5½	3½	24
Cranking out and removing bit, min.	2	3	¾	3	½	1½	2
Cleaning out hole, min.	2	3	0	3	0	0	0
Putting in new bit and cranking back, min.	1	2½	1	4	¾	1½	2
Drilling second 2 ft., min.	15	9	6	10	19	4¾	30
Drilling last 2 ft., min.	15	9	8	10	30
Shifting machine on column, hole to hole, min.	5	7	8	3½	5	5	10
Shifting column, and setting up, min.	20 to 60	25	25	18	31	30	40
Air pressure, lb. per sq. in.	75	75	80	100	75	75	70
Diameter of drill cylinder	3¼	3¼	3¼	3¼	2	2½	3½
Diameter of starting bit	2¾	2½	2½	2	1¾	1¾	2¼
Diameter of finishing bit	2	1½	1¾	1½	1	1¼	1½
Depth of hole	8	12	12	6	4.6	5.5	5.5
No. of holes drilled at one column set up	9	10	12	10	7	8	7
Length of shift, hr.	10	10	10	8	8	8	10
Time lost at blasting, hr.	1	1½	(?)	½	2	1	(?)
Time lost mucking and timbering, hr.	4	(?)	(?)	..	2	..	(?)
Ft. drilled per shift	60	31	38	25

Note: The kind of rock designated by the abbreviations is as follows: Sp., soapstone; Sd., sandstone; Lm., limestone; Gr., granite; Py., quartz porphyry (soft in column J; hard in K); Sl., slate. Column J applies to Rand drills using chisel bits; column K to Leyner-Water drills using X bits in a softer rock.

Rates of drilling in Different Rocks. Unfortunately few published records exist showing rates of drilling in different kinds of rock with given air or steam pressures and given sizes of drill bits. Such scattering records as are to be found merely give the feet of hole drilled per shift. Tables XII and XIII give a fair idea of the speed of actual drilling, and from them together with other data obtained by observation I have compiled the following table for drilling with 3¼-in. machines using air or steam at 70 lb. pressure, starting bit about 2¾ in. and finishing bit about 1½ in.:

	Time to drill 1 ft.
Soft sandstones, limestones, etc.	3 min.
Medium, ditto	4 "
Hard granites, hard sandstones, etc.	5 "
Very hard traps, granites, etc.	6 to 8 "
Soft rocks that sludge rapidly	8 to 10 "

The foregoing data apply only to drilling where no time is lost by the sticking of the bit in the hole, and only with air pressure and bits approximately as above given, and where water jets were not used.

The reader should now read the text on pages 214 to 217, noting especially the falling off in the rate of drilling accompanying decreased air pressure. He should also study the table

on page 216, relating to the effect of size of bit upon speed of drilling, remembering that all the tests there recorded relate only to shallow holes. As holes grow deeper the bit grows smaller, but at the same time the drill steel grows heavier, in consequence of which the last 2 ft. of a deep hole, with a bit only 1½ in. in diam., are ordinarily drilled no faster than the first 2 ft. with a much larger bit. With a powerful drill and a water jet it is quite possible that the last 2 ft. might be drilled faster than the first 2 ft.

Note especially that if a water jet is not used, drilling may actually be slower in a soft, friable rock, like shale, than in the toughest trap. This fact is well brought out in Table XIII, column "K," where the drilling of the second 2 ft. of hole consumed 19 min.! Yet this material was a soft porphyry that with a water jet was penetrated at the rate of 2 ft. in less than 5 min., as shown in column "K." While the Leyner-Water drill (now the Leyner-Ingersoll drill) is an excellent machine for drilling shallow holes in rock that makes sludge rapidly, its excellence is due primarily to the use of water under pressure. In drilling granite its speed is no greater than that of the best types of the ordinary percussion rock drill.

The Sullivan mounted type of air hammer drill uses water under pressure (see Chap. IV).

Using percussive drills of ¾ to 3½ in. size on tripods, the cutting speeds when actually drilling average as follows, according to Dana and Saunders:

Rock	Water Jet	Ft. per min.	Min. per ft.
Limestone	Without jet	0.12	8.3
"	With jet	0.31	3.2
Slate	Without jet	0.14	7.1
Granite	Without jet	0.18	5.5
Sandstone	With jet	0.96	1.0
Schist, quartz	Without jet	0.24	4.2
Porphyry	Without jet	0.27	3.7
Shale	Without jet	0.34	3.0
"	With jet	0.56	1.8

Timing Drilling Processes. In the preceding paragraphs some data were given as to the time elements involved in drilling. The following hints as to timing will serve to indicate its usefulness:

If a stop-watch is not available an ordinary watch with a second hand will serve, and in many classes of work even the second hand can be dispensed with. Before beginning the record, set the minute hand so that it points an even minute when the second hand points at 60. Suppose it is desired to time the drilling of a hole in a seamy mica-schist, using a steam drill mounted on a tripod. At 9:37 A. M. the drill is set up and ready to begin

drilling a hole and exactly 30 seconds later he turns on the steam; then we begin our record:

- 9.37.30 Start.
- 9.49.20 Down.
- 9.51.20 Start.
- 10.00.40 Down.
- 10.03.40 Start.
- 10.09.40 Down.
- 10.13.00 Start.
- 10.14.40 Bit sticks.
- 10.24.40 After hammering the drill repeatedly, the driller is directed to break up some cast iron and throw it into the drill hole.
- 10.32.30 Drilling begins again.
- 10.45.00 Hole finished.
- 11.15.10 New hole started.

It will be seen that drilling started at 9.37.30, and that at 9.49.20 the full length of the feed screw was out, and that to drill farther a new bit had to be inserted. At 9.51.20 the new bit was in and drilling began again, after a delay of 2 min. in changing bits. At 10.00.40 the second bit was down. Each successive bit, it should be stated, is usually 2 ft. longer than its predecessor. At 10.14.40 the bit sticks in the hole due to having run into a pocket of rotten rock. The observer might readily have predicted this sticking by noting the increased rapidity of penetration; for it took nearly 12 min. to drill the first 2 ft. of the hole, and only 6 min. to drill the 2 ft. just prior to the sticking. After wasting 10 min. abusing the drill the driller finally removed the bit (at the direction of the observer), broke up a piece of cast iron pipe into hazel-nut sizes, and threw two handfuls of the iron into the bottom of the hole. Drilling was resumed at 10.32.30, and the last 2 ft. were completed at 10.45.00. At 11.15.10 the driller started another hole, having spent more than 30 mins. shifting the tripod and drill.

What do we learn from this observation, assuming it to be a fair average? First, that the driller was slow in changing bits; second, that he was very slow in shifting his tripod; third, that the driller was ignorant; fourth, that the foreman was equally so; fifth, that fragments of cast iron completely overcome sticking of bits in this rock.

We know that the driller was slow, because other similar observations have proved it possible to change short bits in much less time than 3 mins., and, since the driller has an easy time of it while turning the crank, he can work rapidly without exhausting himself *when it comes to changing bits or shifting the machine.*

We know that both driller and foreman were ignorant, for broken iron should have been provided ready to use in case of sticking of the bit. We conclude that it will pay to assign a man to measure up the footage of hole drilled by each driller every day, and to offer each driller a bonus for every foot of hole drilled in excess of a stipulated minimum.

The foregoing is a record of fact and not of theory. On a large contract job the author secured an increase of 45% in the daily footage of each drill by taking just such observations as the above.

Labor unions often prevent the adoption of the best plan for increasing output, but they can not prevent a manager from knowing where the losses are occurring. There is no excuse, therefore, for failure to study machine work in the manner above outlined.

Having secured minute-hand records of the number of feet drilled in a given time by a rock drill, the observer should check his estimate by talking with the drillers, the foreman, the contractor and the engineers. He will soon discover that these men often have but the vaguest idea of the time lost in changing bits, shifting machines, delays at blasting, etc., although they can give a reliable estimate of the average day's work of a machine. In a word, he will learn that these men, who usually think they know their business, are often exceedingly ignorant of the essential details upon which profit or loss depends.

The most elaborate system of time records and bookkeeping cannot show what minute-hand recording will show. By this I do not mean to decry bookkeeping, but to make it evident that bookkeeping is only a part of a perfect system of cost recording. An essential part of the ideal system that I have in mind would be the frequent examination of every item of labor cost by means of a trained observer equipped with a watch.

Table XIV is a compilation of data on 9 jobs, given in "Rock Drilling" by Dana and Saunders. The drilling was done with Ingersoll-Rand drills ($3\frac{1}{4}$ to $3\frac{1}{2}$ cylinders) on tripods, except on jobs B and I. On job I drills were mounted on columns. On job B a Locker traction drill (described on page 141) was used.

A comparison of job A using tripod drills and job B using the Locker traction drill, on the same kind of rock shows that 21.3% of the total time was lost changing steels on the tripod drill, as compared with no time lost for this reason on the traction drill.

Approximate Determination of Air Pressure at Drills. It is not always easy to gage the air pressure at the drill, but I have found it a simple matter to estimate the pressure with considerable accuracy by noting the number of blows per minute struck by the drill.

Using drill-steel of given weight, first test the drill for speed

at a point so near the compressor or boiler that little or no loss of pressure can occur in the pipe line. Vary the pressure from, say, 80 down to 40 lb. in making the test of the number of blows struck per minute, and thereafter your pencil and your watch will be a good enough pressure gage. The number of blows can be counted by keeping time with a pencil. The pencil, in the hands of the observer, is made to strike a sheet of paper every time the drill strikes the rock. Then at the end of a definite number of seconds, say 15 sec., the number of marks of the pencil point upon the paper are counted, and the number of blows per minute are computed. Once it has been ascertained how many blows a given size drill strikes per minute when working at full stroke, under varying gage pressures, the only gage needed is the pencil, and a watch; for the pressure can be roughly ascertained by determining the number of blows struck per minute. This I have found to be an exceedingly useful means of ascertaining whether or not too many drills are drawing power from a given pipe line. If a given steam boiler or compressor is designed to supply 15 drills, and if it is afterward loaded up with 20 drills, the pressure at each drill will be reduced, resulting in a very decided falling off in the number of feet of hole put down daily by each drill.

Results of a Drilling Contest in Colorado. The following is an abstract from an article in the *Mining Reporter*, July 17, 1902, reprinted in the Leyner drill catalogue. Eleven Water-Leyner drills, now the Leyner-Ingersoll drill (model 5), seven Ingersoll drills and five Sullivan drills (all 3-in.) were entered in a drilling contest at Idaho Springs, Col. Each drill was run by an experienced driller and helper, the different contestants bringing their own drills. A face, or breast, was prepared near the Newhouse Tunnel, where the rock is a "schist of more than average hardness for drill work." Each drill was to put in two 9-ft. holes, one looking up, one down, the angle not exceeding 25° from the horizontal. The finishing bit was 1¾-in. diam. The air pressure was 110 lb. I have summarized the results of this contest as follows: Nine of the Leyner drills finished the contest, three of the Ingersoll drills and two of the Sullivan drills. The following table gives the average results of the drills that finished, as well as the best results of an individual drill of each of the three makes.

In studying this table it is well to note that the first hole was the up hole, and the second hole was the down hole in all cases. It will be noticed that the down hole required much longer to drill than the up hole in the cases of the Ingersoll and the Sullivan drills. The Leyner drill, on the contrary, showed very little difference in speed of drilling either up or down holes; the reason being, I think, due to the fact that the water (under pressure)

Make of Drill.	Setting Up.		Drilling 1st Hole.		Moving 1st to 2d Hole.		Drilling 2d Hole.		Tearing Down.		Total Time.	
	Min.	Sec.	Min.	Sec.	Min.	Sec.	Min.	Sec.	Min.	Sec.	Min.	Sec.
Leyner	4	10	28	20	1	00	23	40	3	10	60	20
Ingersoll	4	35	24	15	1	20	34	30	4	15	69	05
Sullivan	3	30	17	30	0	30	17	50	2	55	42	15
Leyner	5	05	26	40	1	0	42	15	3	15	78	15
Ingersoll †	4	30	27	20	1	25	35	50	4	30	73	35
Sullivan	5	0	23	0	0	30	22	0	3	10	53	40

† This drill was disqualified because the second hole was 4% in. short.

that is used with the Leyner drill keeps the bottom of the hole clean in all cases (up or down holes), leaving no cushion of sludge for the bit to strike upon. The Ingersoll and the Sullivan drills worked to better advantage in the up, or dry holes, than in the down, or wet holes; because the water used in the wet holes was not forced in through a pipe, but merely thrown into the hole with a tin cup (as is the ordinary method of "tending chuck"), and in a rock that makes sludge rapidly, as many schists do, the sludge accumulates under the bit and cushions its blow. In an up (dry) hole, however, the chips and dust roll out of the hole as fast as formed, so that much better speed is possible in a rock that cuts rapidly, as this particular "schist" evidently does. The Leyner drill is an excellent drill in soft rocks, and drills well also in hard rocks, but with a greater air consumption than any other make of drill, as is shown on page 217.

Record of a Drifting Contest in Arizona. The Vekol Mining Co. near Casa Grande, Pinal County, Ariz., was advancing a drift in hard blue limestone from the 120-ft. level. The size of the drift was 8 x 6 x 4¼ ft., and the working face was about 500 ft. from the shaft. The drilling was done with a Sullivan 2¾-in. air drill on a double screw mining column. Two drill runners had a contest to see which one could break the most rock in five shifts, with results as follows, as given in *Mines and Minerals*:

Shifts.	1	2	3
Minutes to set up	26	16	19
No. holes drilled	11	11	12
No. ft. drilled	94	95	102
Ave. depth holes in ft.	8.54	8.6	8.5
Total working time	7 h. 54 m.	6 h. 25 m.	7 h. 15 m.
Feet of advance per shift	7.0	6.9	6.9
Shifts.	4	5	Averages
Minutes to set up	21	17	19.8
No. holes drilled	10	12	11.2
No. ft. drilled	85	92	93.6
Ave. depth holes in ft.	8.5	7.66	8.36
Total working time	7 h. 10 m.	7 h. 2 m.	7 h. 9 m.
Feet of advance per shift	5.1	5.0	6.17

The time for setting up included the time required by the men in walking from the shaft station on the 120-ft. level until the air was turned on at the drill. The total working time included setting up, drilling, tearing down, loading and blasting. Seventy-five pounds of $1\frac{1}{4}$ -in. powder were used per round of holes. A Sullivan straight-line, two-stage compressor furnished power for the drills at 110 lb. receiver pressure.

Records of a Year's Drill Work in a Pennsylvania Quarry. In *Engineering and Contracting*, May 16, 1906, are published records of a year's work with percussive drills. The average rate made by seven drills was 11.8 ft. per hr. per drill in limestone, for a period of one year. This is astonishing, and was probably due to the moderately easy rock, the payment of the men in proportion to the number of feet drilled, the condition of the drills, the high air pressure used, and the good management.

The work was for the General Crushed Stone Co., South Bethlehem, Pa., in a quartzite quarry and in a limestone quarry. The quartzite occurs in thin laminations whose bed makes an angle of about 15 degrees with the horizontal, dipping toward the quarry. The limestone is hard and tough, the top 20 ft. being a conglomerate of sharp flint and limestone, which is fairly easy to drill but hard on the drill steel. The laminations are horizontal.

Each driller and helper were paid about 6.5 ct. per ft. drilled in the quartzite quarry and 4.5 to 5 ct. in the limestone quarry. In the trap rock quarry the men were paid by the day and a bonus was given for every foot drilled in excess of a specified number. The driller and helper together earned about \$4 per day.

The holes in quartzite were drilled to a depth of 20 ft. The

TABLE XV. DRILLING IN PENNSYLVANIA QUARRY

No. of drills.	Ingersoll Sergeant Type Drills.	No. of ft. per year.	No. of days.	Average ft. per hr. per drill.	Max. av. per hr. each drill.	Min. av. per hr. each drill.	Cost of repairs per ft.
Quartzite (1904):							
9	F9	101,379	1,525	6.65	7.03	6.12	0.61ct.*
Quartzite (1905):							
8	F9	118,597	1,383	8.47	9.25	7.55	0.64ct.†
Limestone (1903):							
7	F9	93,118	922	10.1	10.7	9.37	0.31ct.*
Limestone (1904):							
7	F9	114,430	1,130	10.13	11.47	9.32	0.56ct.*
7	F9	107,837	913	11.8	12.69	10.0	0.57ct.†
Exceedingly Hard Trap (1905):							
5	F9	36,973	1,411	2.62	3.05	2.58	1.7ct.†
4	A32	2.57	2.24

* Drill parts only. † Drill parts, steel and hose.

holes in limestone averaged about 15 ft. deep, and ranged from 14 to 16 ft. In the trap rock the range was from 8 to 20 ft., averaging about 12 to 14 ft. Holes were spaced 6 ft. apart in two rows, the first row being from 4 to 6 ft. from the face and the second row from 3 to 5 ft. in back of the first row, the holes being staggered. The average diameter of the starting drill was $3\frac{1}{4}$ in. and of the finishing drill $1\frac{3}{4}$ in., the drills decreasing by $\frac{1}{8}$ to $\frac{3}{16}$ in. per drill. Ingersoll-Sergeant drills were used. The F-9 drills have $3\frac{5}{8}$ x 7-in. cylinders, and the A-32 have $2\frac{1}{2}$ x 5-in. cylinders.

Two Months Record of Drill Work in an Oklahoma Quarry. (*Engineering and Contracting*, Aug. 3, 1910.) This record is for two months' work at the crushed stone quarries of the Webster Stone Co., Fitzhugh, Okla., and is furnished by the manager, Mr. W. H. Webster. The quarry has three different qualities of stone. The top 5 ft. is rather loose stratified rock, which is very hard; the next 20 ft. is of a shell formation and is not so hard, and the bottom 20 ft. is a silicious limestone having more or less free silica mixed with the lime, and is quite hard and solid, but not very hard to drill as the stone is very compact. The face of the quarry ranges from 44 to 46 ft. high.

Two sizes of Wood drills are used. One is a $2\frac{3}{4}$ -in. drill made for drilling 12 ft., but here another 4 ft. has been added, making 16 ft. of steel which the drill handles easily. This drill has been in use since 1903, 7 years, and the expense of maintenance has not been to exceed \$15 for the 7 years. The other drill is a $3\frac{5}{8}$ -in. Wood drill. This drill has been in use 60 days, with no maintenance expense. It drills up to 20 ft.

Extra large steels are used, the starter and up to 6 ft. being 2 in.; from 6 to 12 ft., $1\frac{7}{8}$ in.; from 12 to 16 ft., $1\frac{1}{2}$ in.; and from 16 to 20 ft., $1\frac{3}{8}$ in. These large steels are found to be an advantage in shaping the bits and also in wearing qualities; for giving more steel to work on prevents the steel from crystallizing under the constant pounding.

The power used to run this $3\frac{5}{8}$ -in. drill is steam furnished by a 10-hp. traction engine, which is moved along with the drill and kept as close as possible to reduce steam condensation. Steam can be carried as far as 150 ft. from the boiler, but the best results are had at not to exceed 30 ft.

The machinery is handled by 3 men; 1 fireman, 1 driller and 1 helper. The practice is to drill the top 5 ft. and blast it off to prevent spalls from falling into the deeper holes. The rest of the face is drilled in two drillings of 20 ft. to each bench. The holes are spaced 12 to 15 ft. from the quarry face and 10 ft. apart. The holes are started $3\frac{1}{2}$ in. in diameter and decrease $\frac{1}{8}$ in. in diameter for each 2 ft. lengths of bit.

The holes are pumped with a long pipe pump made in the blacksmith shop from 1¼-in. black iron pipe with a steel ball valve at the bottom. Best results are obtained with this pump by using a steam blower.

With the 2¼-in. drill from 40 to 90 ft. of hole are drilled per 10-hour day, the average being 70 ft. The record of the 3⅝-in. drill for May and June, 1910, is given below. In May the drill was in operation 93½ hr. and drilled 515 ft. in an average of 55 ft. per 10-hr. day, at an average cost of 11.57 ct. per ft. In June the drill worked 130 hr. and drilled 599 ft., or an average of 46 ft. per 10 hr. at an average cost of 11.83 ct. per ft.

DAILY REPORT FOR MAY AND JUNE, 1910, FOR 3⅝-IN.
WOOD DRILL

May			June		
Date.	No. ft.	No. hr.	Date.	No. ft.	No. hr.
6	31	5	1	73	10
7	64	8	2	44	10
10	50	9	3	40	10
11	30	8	7	50	10
12	41	10	8	40	10
13	40	8	9	24	7
17	30	9	10	54	10
18	42	10	11	44	10
19	17	2	13	22	5
20	10	1	14	18	5
26	36	7	15	52	10
27	56	8½	16	52	10
31	65	8	17	18	5
			29	24	8
			30	44	10
	515	93½			
				599	130

Transvaal Stope Drill Competition.* For a number of years there have been attempts on the Rand to determine the efficiency of rock drilling machines with the object of determining the comparative cost of machine drilling and that of hand drilling with the labor there available. The contest for 1909, which lasted nearly a year, is the only one which has really been a thorough test. The other tests were for very short periods of time and carried out on the surface. A test of this kind, drilling holes in the granite blocks, is a very different proposition from that of using a machine for a period covering nearly a year underground. The contest was instituted by the Chamber of Mines, assisted by the Transvaal Government. A first prize of £4,000, and a second prize of £1,000, together with the running expenses of the contest, were borne jointly by the Chamber of Mines and the Government.

Nineteen different types of machines were entered for the contest, of which 9 were discarded after the elimination trials made on the surface, and later underground, and ten machines actually

* Abstracted from the report of the Joint Committee on the Transvaal stope-drill competition. Reprinted in *Engineering and Contracting*, Feb. 22, 1911.

entered the trial to continue for 300 shifts. These machines were the Holman $2\frac{1}{8}$ in., Holman $2\frac{3}{4}$ in., Siskol, Climax, New Century 0.0., Chersen, Imperial, Komax, Murphy, Waugh and Westfalia. The stope drill committee decided the contest on the basis of footage costs. Very low costs were obtained in spite of the fact that the men were unfamiliar with the machines at the beginning of the work. The machines not eliminated or withdrawn before the end of the contest were all of about 100 lb. weight, the lighter machines having proved ineffective. The limits of pressure for compressed air were fixed at from 60 to 75 lb. per sq. in.

In the estimates the cost of drill steel has been taken at 1 ct. per ft. drilled, and the cost of sharpening at 2 ct. per ft. The experience during the competition would point to a much higher figure for the cost of steel, but there is no doubt that a large number of the jumpers provided for the competitors were mislaid and became mixed up with the mine stock. However, the actual cost of steel is a figure which affects both results similarly, and it may therefore be reckoned as an important fact established by means of this competition that machine drilling in moderately narrow stopes costs no more, and perhaps even less, than hand drilling by natives.

The committee having carefully considered the results, made the recommendation that the first and second prizes should be divided between the Holman $2\frac{1}{8}$ -in. and the Siskol drills. It will be seen that the latter machine drilled more footage, but cost more for spares, but the costs per foot drilled were so remarkably close that it was considered that the machines could fairly be said to have tied.

The points to be noted in connection with the four machines which worked to the close of the competition are as follows:

The Holman $2\frac{1}{8}$ -in. seemed a little too small, but it drilled well, was easy to handle, and its maintenance was the lowest of all, which fact largely assisted in keeping it in the leading position.

Both the Holman $2\frac{3}{4}$ -in. and the Chersen had a common fault in that the travel of their valves was very small and easily interfered with by dirt. They also did not drill well in awkward ground and were apt to "fitcher" and stick, thus giving considerable trouble.

The Siskol was of a very convenient size, drilled fast and used a moderate amount of air. Its cradle was faulty in design, as no arrangement had been made for adjustment after wear in the slides, or the feed-screw nut. Its long stroke and length of feed, assisted it in drilling deep holes, often up to six feet. Its maintenance was heavy, especially in the front-head bushing and chuck. *The operators found this machine easy to handle, and they liked*

it. The New Century 0.0 machine, which worked until almost the close of the competition, was, like the Holman 2½-in., rather too small and wanting in power. Its feed screw and cradle were too short, necessitating the use of five drills to drill a 4-ft. hole, thus making extra cost in transportation and in sharpening drills.

The committee arrived at the following general deductions as a result of the competition: (1) that pneumatic hammer-drills were not suitable for the general stoping conditions prevailing on the Rand; (2) that hollow steel cannot be recommended, owing to its high cost and difficulty in tempering; (3) no new type of "rig-up" gear submitted or used came up to the Holman type; (4) that any capable miner can efficiently supervise the working of more than two small machines; (5) that five native assistants are necessary to enable a miner to run two machines properly; (6) a good supply of drills should in all cases be available for the miners; (7) five natives being proved as necessary, the machines can be strengthened, as one weighing 125 lb. can under these circumstances be as easily handled as 100-lb. machines; (8) that under suitable conditions ground can be as cheaply broken with machines as with hammer boys; (9) that machines with long-stroke valve-gears are more efficient than those with short strokes, as they are less apt to get choked; (10) that machines with long piston-strokes proved themselves superior to those with a shorter stroke; (11) that provision of a feed of not less than 18 in. in length appears very desirable.

The following costs of operation are given for the four surviving drills:

Holman 2½-in. Drill:	
White labor	\$ 523.52
Native labor	647.97
Air	444.69
Drill sharpening, at 2 ct. per ft. hole	259.30
Drill steel, at 1 st. per ft. hole	129.66
Spares	119.55
Stores	111.49
Depreciation of machines	296.75
Total	\$2,532.93
Footage to count	12,779
Ft. per shift for 2 machines	59.4
Cost per ft. drilled	\$0.195
Siskol Drill:	
White labor	\$ 523.52
Native labor	639.31
Air	444.10
Drill sharpening at 2 ct. per ft. hole	285.76
Drill steel, at 1 ct. per ft. hole	142.89
Spares	362.81
Stores	147.31
Depreciation of machines	283.98
Total	\$2,829.68
Footage to count	14,083
Ft. per shift for 2 machines	65.5
Cost per ft. drilled	\$0.198

Holman, 2 3/4-in. Drill:	
White labor	\$ 523.52
Native labor	681.40
Air	445.58
Drill sharpening at 2 ct. per ft. hole	238.29
Drill steel, at 1 ct. per ft. hole	119.15
Spares	225.72
Stores	119.51
Depreciation of machines	248.05
Total	\$2,601.24
Footage to count	11,744
Ft. drilled per shift for 2 machines	54.6
Cost per ft. drilled	\$0.218
Chersen Drill:	
White labor	\$ 523.52
Native labor	658.50
Air	383.36
Drill sharpening at 2 ct. per ft. hole	239.05
Drill steel, at 1ct. per ft. hole	119.53
Spares	606.55
Stores	117.67
Depreciation of machines	207.27
Total	\$2,855.43
Footage to count	11,781
Ft. per shift for 2 machines	54.8
Cost per ft. drilled	\$0.239

Rule for Estimating Feet Drilled per Shift. We are now possessed of sufficient data to enable us to formulate a rule whereby the number of feet drilled per shift, under given conditions, may be predicted. I will not go into the method that I used in deducing the following rule, which is strictly correct, for the method is one of simple arithmetic. The rule is:

To find the number of feet of hole drilled per shift divide the total number of working minutes in the shift by the sum of the following quantities: The number of minutes of actual drilling required to drill one foot of hole, plus the average number of minutes required to change bits divided by the length of the feed screw in feet, plus the average number of minutes required to shift the machine from hole to hole divided by the depth of the hole in feet.

Suppose, for example, the shift is 10 hr. long, that is 600 min.; that it requires 5 min. to drill 1 ft. of the rock; that it requires 4 min. to change bits and clean hole; that the feed screw is 2 ft. long; that the machine can be shifted from hole to hole in 16 min.; and that each hole is 8 ft. deep. Then according to the rule we have: The number of feet of hole per shift is $600 \div 5 + \frac{1}{2} + 1\frac{1}{8}$, which is equivalent to $600 \div 9$, or 66 2/3 ft. drilled per 10-hr. shift.

For those who can use simple algebraic formulas the above rule is much more compactly expressed in the following formula:

$$N = \frac{S}{r + \frac{m}{f} + \frac{s}{D}}$$

N = number of feet drilled per shift.

S = length of working time of shift in minutes = 600 for a 10-hr. shift when no time is lost by blasts, break-downs, etc.

r = number of minutes of *actual* drilling (while the drill is hammering required to drill 1 ft. of the rock (see pages 164 and 165)).

m = number of minutes required to crank up, change drills, pump out hole and crank down.

m = 3 to 4 min. ordinarily.

f = length of feed screw, in ft., ranging from $1\frac{1}{4}$ ft. in "baby" drills to $2\frac{1}{2}$ ft. in largest drills, but ordinarily 2 ft.

s = number of minutes required to shift machine from one hole to the next, including the time of chipping and starting the new hole, but not including the time of cranking up and cranking down.

s = 5 min. for very rapid shifting of a tripod machine on level rock.

s = 12 min. for moderate speed of shifting a tripod machine on level rock.

s = 20 min. for very deliberate shifting of tripod machine on level rock.

s = 30 to 40 min. for difficult set up of tripod in irregular rock surface.

s = 25 min. divided by the number of holes drilled from one column set up (when columns are used) plus 2 min.

D = depth of hole in ft.

Even a casual study of the foregoing formula, or rule, must impress the practical man with the importance of the lost time elements in machine drilling; consequently of the value of timing the operations of changing bits and moving machines when the men do not know that they are being timed. Another feature that stands out strikingly is the reduced output of a drill working in a shallow hole. Let the reader solve a few problems, assuming first an average depth of hole of 16 ft. and finally an average depth of only 2 ft. (such as occurs often in the skimming work in road building), and he will never make the blunder of the contractor who bid the same price for rock excavation on the 2-ft. deepening of the Erie Canal as had been bid for the 36-ft. excavation on the Chicago Canal.

The best way of showing the remarkable effect that the depth of hole has upon the number of feet drilled, when the drill is mounted upon a tripod, is to apply the rule just given. If we assume that the shift is 10 hr. long; that the rate of drilling is 1 ft. in 5 min.; that it takes 4 min. to change bits and pump *out the hole* at each change of bits; that the feed screw is 2

ft. long; and that it takes 15 min. to shift from one hole to the next; by applying the rule we obtain the following results:

Depth of hole, ft.	1	2	3	5	10	15	20
Feet drilled in 10 hr.	27	41	50	60	70	75	80

When drillers are lazy they may readily consume 8 min. in changing bits and pumping out the hole each time. With all conditions the same as before, excepting that 8 min. are consumed in changing bits, we have the following results:

Depth of hole, ft.	1	2	3	5	10	15	20
Feet drilled in 10 hr.	25	36	43	50	57	60	62

It will be seen that in deep hole drilling 20% decreased efficiency results from just a little laziness in changing bits, under the conditions assumed; and in softer rocks the percentage of decreased efficiency is much greater. Where the holes are shallow the time involved in shifting from one hole to the next becomes an important factor. Assuming that the conditions are the same as in the first instance, except that 30 min. are consumed in shifting from one hole to the next, then we have the following results:

Depth of hole, ft.	1	2	3	5	10	15	20
Feet drilled in 10 hr.	16	27	35	46	60	67	70

In similar manner I might tabulate other results derived by varying the different time elements in drilling; but enough has been given to show the supreme practical importance of studying these details, which so many practical men have apparently ignored. I leave it to the reader to apply the rule, or formula, to other cases, for the results of such personal application of the rule will stick in the memory and be of more real value than much reading of tabulated information.

Average Footage Drilled per Shift. That the inexperienced reader may have a good general conception of what constitutes a day's work under ordinary conditions the following summary may be of benefit: In drilling vertical holes, with the drill on a tripod, the holes being from 10 to 20 ft. deep, shift 10 hr. long, I have found that in the hard "granite" of the Adirondack Mts., N. Y., 48 ft. is a fair 10-hr. day's work. In the granites of Maine and Massachusetts 45 to 50 ft. is a day's work. In New York City, where the rock is mica schist, deep holes are drilled at the rate of 60 to 70 ft. per 10-hr. shift by men willing to work, but 40 to 50 is nearer the average of union drillers. In the very hard trap rock of the Hudson River 40 ft. is considered a fair day's work. In the soft red sandstone of northern New Jersey 90 ft. are readily drilled per day wherever the rock is not so seamy as to cause lost time by the sticking of the bit; in fact, I have records showing 110 ft. per 10-hr. shift in this rock. In the hard limestone near Rochester my records show about 70 ft. per 10-hr. shift. In the limestone on the Chicago

Drainage Canal, 70 to 80 ft. was a 10-hr. day's work. In the hard syenite of Douglass Island, in open pit work, and where it is difficult to make set-ups, 36 ft. was the average per 10-hr. day. In the limestone near Windmill Pt., Ontario, 3 $\frac{5}{8}$ -in. drills average 75 ft. a day (holes 18 ft. deep); 2 $\frac{1}{2}$ -in. drills, 60 ft. a day, and "baby" drills, 37 ft. a day.

The foregoing examples all apply to comparatively deep vertical holes, in open excavation. In tunnel work there is no reason why a drill should not do about the same work per shift, were there no delays in timbering, mucking, waiting for gases to clear, etc. Such delays, however, often reduce the drill footage very much.

Daily Cost of Operating Percussive Drills. Cost of drill operation depends somewhat upon the number of drills operated, hence I will assume several different typical plants in the following illustrations of daily cost.

On very small jobs it is not customary to keep an extra drill on hand, but it is economy in the long run to do so, hence where one to three drills are to be kept in active operation, one additional drill should be provided in case of a break down. On jobs of medium size, where 6 to 12 drills are to be kept busy one shift daily, provide one spare drill for every 3 or 4 drills that are to be kept busy. Where a very large number of drills are worked, at least one spare drill should be provided for every 6 drills actively at work.

DAILY COST OF A 6 STEAM DRILL PLANT

The drills are assumed to be 3 $\frac{1}{4}$ in. size.

6 drillers at \$3.50	\$21.00
6 drill helpers at \$2.50	15.00
2 muckers at \$2.00	4.00
1 nipper at \$2.00	2.00
1 blacksmith at \$4.00	4.00
1 blacksmith helper at \$2.50	2.50
1 pipe fitter at \$3.00	3.00
1 fireman at \$2.50	2.50
$\frac{1}{2}$ team and driver, hauling 2.5 ton coal, etc., at \$5.00	2.50
$\frac{1}{2}$ foreman at \$5.00	2.50
$\frac{1}{2}$ time keeper at \$3.00	1.50
Total daily wages	\$60.50
Interest and taxes, 8% on \$2,400 for 8 drills (2 idle) divided by 150 days	\$ 1.30
Interest and taxes on \$1,500 for boiler, pump, and pipe	0.80
Depreciation, 15% on \$2,400 for drills divided by 150 days	2.40
Depreciation, 10% on \$1,500 for boiler and pipe divided by 150	1.00
Repairs on 6 active drills at \$0.75	4.50
Repairs, boiler, pump and pipe	1.50
Steam hose renewals, 6 drills, at \$0.25	1.50
Wear of drill steel and blacksmith tools	3.50
Charcoal for blacksmith, 120 lb.	0.60
Coal, 2.5 tons at \$3.00	7.50
Oil for 6 drills, 1 $\frac{1}{2}$ gal. at \$0.30	0.45
Installing and removing plant, \$150 divided by 150 days	1.00
Total daily plant charges and supplies	\$26.05
Grand total daily cost	\$86.55

If the 6 active drills average 60 ft. of hole drilled per day, the cost per ft. of drill hole is $\$86.55 \div 360 = 24$ ct. nearly, exclusive of general management and office expense.

The "muckers" are laborers engaged in clearing away earth and loose rock from the sites of proposed drill holes. Their number will vary, depending on local conditions, there being not infrequently almost as many muckers as drills.

The "nipper" carries drill steels to and from the forge.

A steam pipe fitter will be kept busy on the pipe lines, and if the lines are long more than one pipe fitter will be required.

The cost of hauling fuel of course depends largely on the length of haul and character of roads, hence the above estimate is merely illustrative.

It is assumed that the foreman and timekeeper are engaged half their time with other gangs. Often their entire time is spent on a small drilling gang.

It is assumed for illustration, that out of 300 working days in the year only 150 days are actually worked; hence I use 150 as a divisor in calculating the daily interest charge. The drill depreciation rate is 15% per year of continuous one-shift work (150 shifts) for, at the end of about 1,000 shifts, it is usually found economic to scrap a drill that has received the ordinary severe usage.

Repairs, which include materials and labor involved in renewing worn parts, will be found to rise as the drill grows older; but the 75 ct. per drill per 10-hr. shift is a fair average over a period of years. The best grade of rubber hose (25 ct. per ft.) lasts about two months, but flexible metallic tubing (\$1 per ft.) lasts three or four times as long.

Coal consumption ranges from 700 to 1,000 lb. per drill per 10-hr. shift for 3¼- to 3½-in. drills. A 100 hp. (rated at 140 lb. pressure) boiler will serve 6 drills of 3½-in. size.

Daily Cost of 1 and 2 Steam Drill Plants. Frequently the amount of work to be done warrants the use of only one or two drills. Even where one drill would suffice, it is generally best to use at least two drills, thus hurrying the drilling to completion at a lower cost per foot of drill hole. However, if the rock varies much in toughness, fissures, etc., it may be false economy to drill holes far ahead of the daily blasting requirements, for it is usually found desirable to vary the spacing of holes depending upon the manner in which the rock breaks on blasting.

A small upright boiler on skids or a horizontal boiler on wheels (preferably a traction engine) may be used for small jobs. If there is but one drill to be operated a crew of four men will suffice, *thus*:

Wages:

1 driller	\$ 3.50
1 drill helper	2.50
1 fireman	2.50
1 blacksmith	3.50
Total daily wage	\$12.00

Plant Charges and Supplies:

Interest and taxes on 2 drills (1 spare), 8% of \$600 divided by 100 days	\$ 0.50
Interest and taxes \$600, boiler, pipe, tools, etc.	0.50
Depreciation of drills	0.40
Depreciation of boiler, etc.	0.40
Repairs per active drill, \$0.75	0.75
Repairs on boiler, etc.	0.40
Steam hose removals	0.25
Wear of drill steel and tools	0.50
Coal, 0.3 long ton at \$4.00 delivered	1.20
Oil for drill, 2 pt. at 40 ct. per gal.	0.10
Installing and removing plant, \$50 divided by 100 days	0.50
Total daily plant charge	\$ 5.50

Grand total daily (10 hr.) cost	\$17.50
--	----------------

If water for the boiler and drill has to be hauled, add accordingly, assuming 7 lbs. of water per lb. of coal, or about 2.3 short tons of water per drill shift.

If the drill averages 50 ft. of hole per day (10 hr.), the cost per ft. of hole is $\$17.50 \div 50 = 35$ ct., exclusive of foreman, general management and office expense. This can be somewhat reduced if the drill steels can be sharpened by the piece, say at 4 ct. per bit, by a local blacksmith.

Another working drill would add only \$6 a day in wages and about \$3.50 in plant charges, or a total of \$9.50. This \$9 added to the \$17.50 gives \$27 as daily cost for two working drills. With an output of 100 ft. of hole per day this gives a cost of 27 ct. per ft.

It should be noted that I have assumed only 50 ft. of hole per drill day where only one or two drills are worked, as against 60 ft. where 6 drills are worked. My experience indicates that there is fully this difference in footage output per drill, the reasons being that in a very small gang: (1) A larger part of the time of a driller and helper is spent "mucking" out earth and loose rock for the drill site; (2) the drill gang must assist in moving steam pipes, etc.; (3) a foreman can not be employed continuously to supervise the drilling work.

Daily Cost of a 12 Air Drill Plant. The drills are assumed to be 3¼-in. size, but the following costs will apply closely enough to 3½-in. drills.

Wages:

12 drillers at \$3.50	\$ 42.00
12 drill helpers at \$2.50	30.00
4 muckers at \$2.00	8.00

2 nippers at \$2.00	4.00
2 blacksmiths at \$4.00	8.00
2 blacksmith helpers at \$2.50	5.00
1 pipe fitter at \$3.00	3.00
1 pipe fitter's helper at \$2.50	2.50
1 engineman at \$4.00	4.00
1 fireman at \$2.50	2.50
1 team and driver hauling coal, etc., at \$5.00	5.00
1 foreman at \$5	5.00
1 water boy at \$1.50	1.50
1 timekeeper at \$3.00	3.00
Total daily wage	\$123.50

Plant Charges and Supplies:

Interest and taxes, 8% on \$4,800 for 16 drills (4 spare drills) divided by 150 days	\$ 2.60
Interest and taxes, 8% on \$7,200 for air compressors, boilers, pipe, etc., divided by 150 days	3.80
Depreciation, 15% on \$4,800 for drills divided by 150 days	4.80
Depreciation 10% on \$7,200 for compressors, etc., divided by 150 days	4.80
Repairs on 12 active drills at \$0.75	9.00
Repairs on compressors, etc.	3.50
Air hose renewal, 12 drills at \$0.20	2.40
Wear of drill steel and blacksmith tools	7.00
Charcoal for blacksmith, 240 lb.	1.20
Coal, 5 tons at \$3.00	15.00
Oil for 12 drills, 3 gal. at \$0.30	0.90
Oil for compressor, 3 gal. at \$0.30	0.90
Installing and removing plant, \$1,500, divided by 150 days	10.00

Total plant charge and supplies

\$ 65.90

Grand total daily (10 hr.) cost

\$189.40

If the 12 active drills average 60 ft. of hole per day (10 hr.), we have a total daily footage of 720 ft., which divided into \$189.40 gives nearly 27 ct. per ft. exclusive of general management and office expense.

In the above illustration I have assumed that the cost of the compressor plant (compressor, engines, boiler, air pipes, etc.) is \$600 per active drill or \$7,200. This is a fair average where the plant is of a portable nature. Such a plant can be installed and housed in a cheap wooden building for about \$1,500 including cost of building material (see page 239).

A compressor plant of high fuel efficiency, installed in permanent buildings, as at a mine, costs \$1,000 or more per active drill (3¼-in.), exclusive of the drill itself.

Cost of Sharpening Bits. The cost of sharpening bits deserves consideration. Examples of costs are given in Chapter III, pages 56 to 62. The cost of carrying bits to the shop should also be considered. The weights of drill steels per ft. are given on page 51. A "nipper," or man who carries the steels back and forth from the forge to the drills, will ordinarily carry 75 lb. and walk at a speed of about 100 ft. per min., but he will spend about one-third his time resting.

Cost of Percussive Drill Repairs and Renewals. Mr. Thomas

Dennis, agent of the Adventure Consolidated Copper Co., Hancock, Mich., has kindly furnished the following data of the average monthly cost of keeping a drill in repair:

Supplies for repairs	\$1.31
Machinist labor	8.45
Blacksmith labor	1.60
Total repair charge per month	<u>\$11.36</u>

The number of drills in the shop at any one time is about 15% of the total number. This low cost is based upon work where a large number of drills are used and well handled by the users.

In open cut work my experience is that 75 ct. per drill per shift is a fair allowance for renewals and repairs.

In the gold mines of South Africa, where each drill works two shifts per day, the cost of drill repairs is \$300 per drill per year; while the first cost of a 3¼-in. drill with bar is \$185, according to a 1903 report of the Government Mine Inspector.

Mr. Josiah Bond, General Manager American Copper Mining Co., Somerville, N. J., wrote me as follows in 1904:

"As to the matter of drill repairs, I can give you only a few figures. In using drills for years, I find I have accurate figures for drill repairs for only three years. These place the repairs per drill at \$102.00, \$100.50 and \$93.76 per year. My opinion is that a drill used night and day for a year is sufficiently worn to make it good business to throw it away; though if a drill is used by only one man, and he is made responsible for its condition, I think the life of a drill is at least three years (one shift). Of course, studs and side rods will have to be replaced occasionally, and other small repairs must be made. A well-made heavy bar or column should out-last four drills, and arms are probably strong enough to kill three drills. And the drill itself is the weak part; as soon as the cylinder and piston are enough worn to make a day's work only 80 ft. instead of 120, or even 100 ft., it is clear that you are losing money by keeping it at work. I have always wanted two idle drills and one idle column and arm, etc., for five working drills. From my practice, which has been a pretty hard one, developing with low-priced labor, I should estimate a stoping drill to cost, including repairs and its own life, about 50 ct. per shift.

"Where an operation is large enough to warrant the erection of a machine shop, sufficiently equipped to make all parts of drills, this cost can probably be cut in two; and in old mines, even *without this*, where the work is more regular, a saving can be made, because breakages do not occur so often. My practice has been *without the luxury* of a good shop, and all repairs are pur-

chased, with the exception of a few of the simple parts, like side rods, etc.

“ Much depends on the care given a drill, and the rock to be drilled makes a great difference also, but the above figures are, I should hope, outside prices; but in my work, drills have always been a secondary consideration.”

The following table gives the cost of repairing 25 drills for 11 months in 1905, at the Wabana Iron Mines, Nova Scotia:

Month of	Total repairs	Amt. per drill per month
January	\$ 68.32	\$2.86
February	85.53	3.576
March	165.10	6.007
April	33.92	1.21
May	46.98	1.86
June	49.41	1.98
July	110.89	4.49
August	316.81	13.50
September	140.62	5.20
October	259.60	10.66
November	204.75	7.80
Total and av.	\$1,481.93	\$5.40

In addition to this add \$1.75 per day for labor or 7 ct. per drill per day, or \$2 per month, making a total of \$7.40 per drill per month.

The average cost of repairs was \$5.40 per month per drill (drills worked one shift only each day), not including the cost of labor of repairing. It takes all of one man's time, at \$1.75 per day, keeping the drills in repair, or practically \$2.00 per month per drill. The parts used in making repairs are all bought of the manufacturers. We see that the total cost of drill repairs has been about \$7.40 per drill per month, or 30 ct. per drill per 10-hr. day, which is a very moderate cost, and speaks well not only for the make of the drills, but for the care given to them.

Mr. J. B. Lippincott, in *Engineering News*, April 22, 1909, states that the cost of repairs to 3 Leyner No. 9 drills in gneissoid granite on the south end of the Elizabeth tunnel, averaged, during three months, 47 ct. per drill per lin. ft. of tunnel or about 11 ct. per drill per cu. yd. of rock.

Cost of Percussive Drill Repairs in Washington Tunnel Work.*
 For information regarding the cost of drill repairs on tunnel work, I am indebted to Mr. Chas. H. Swigert. The work was that of driving two tunnels on the Tieton Project of the U. S. Reclamation Service, near North Yakima, Washington. Two Wood drills were used, one in each heading.

Compressed air was used to operate the drills, one drill working in each heading. The North Fork tunnel was 3,811 ft. long

* *Engineering and Contracting*, Oct. 14, 1908.

Dennis, agent of the Adventure Consolidated Copper Co., Hancock, Mich., has kindly furnished the following data of the average monthly cost of keeping a drill in repair:

Supplies for repairs	\$1.31
Machinist labor	8.45
Blacksmith labor	1.60
Total repair charge per month	\$11.36

The number of drills in the shop at any one time is about 15% of the total number. This low cost is based upon work where a large number of drills are used and well handled by the users.

In open cut work my experience is that 75 ct. per drill per shift is a fair allowance for renewals and repairs.

In the gold mines of South Africa, where each drill works two shifts per day, the cost of drill repairs is \$300 per drill per year; while the first cost of a 3¼-in. drill with bar is \$185, according to a 1903 report of the Government Mine Inspector.

Mr. Josiah Bond, General Manager American Copper Mining Co., Somerville, N. J., wrote me as follows in 1904:

"As to the matter of drill repairs, I can give you only a few figures. In using drills for years, I find I have accurate figures for drill repairs for only three years. These place the repairs per drill at \$102.00, \$100.50 and \$93.76 per year. My opinion is that a drill used night and day for a year is sufficiently worn to make it good business to throw it away; though if a drill is used by only one man, and he is made responsible for its condition, I think the life of a drill is at least three years (one shift). Of course, studs and side rods will have to be replaced occasionally, and other small repairs must be made. A well-made heavy bar or column should out-last four drills, and arms are probably strong enough to kill three drills. And the drill itself is the weak part; as soon as the cylinder and piston are enough worn to make a day's work only 80 ft. instead of 120, or even 100 ft., it is clear that you are losing money by keeping it at work. I have always wanted two idle drills and one idle column and arm, etc., for five working drills. From my practice, which has been a pretty hard one, developing with low-priced labor, I should estimate a stoping drill to cost, including repairs and its own life, about 50 ct. per shift.

"Where an operation is large enough to warrant the erection of a machine shop, sufficiently equipped to make all parts of drills, this cost can probably be cut in two; and in old mines, even *without this*, where the work is more regular, a saving can be *made, because breakages* do not occur so often. My practice has *been without the luxury* of a good shop, and all repairs are pur-

chased, with the exception of a few of the simple parts, like side rods, etc.

"Much depends on the care given a drill, and the rock to be drilled makes a great difference also, but the above figures are, I should hope, outside prices; but in my work, drills have always been a secondary consideration."

The following table gives the cost of repairing 25 drills for 11 months in 1905, at the Wabana Iron Mines, Nova Scotia:

Month of	Total repairs	Amt. per drill per month
January	\$ 68.32	\$2.86
February	85.53	3.576
March	165.10	6.007
April	33.92	1.21
May	46.98	1.86
June	49.41	1.98
July	110.89	4.49
August	316.81	13.50
September	140.62	5.20
October	259.60	10.66
November	204.75	7.80
Total and av.	\$1,481.93	\$5.40

In addition to this add \$1.75 per day for labor or 7 ct. per drill per day, or \$2 per month, making a total of \$7.40 per drill per month.

The average cost of repairs was \$5.40 per month per drill (drills worked one shift only each day), not including the cost of labor of repairing. It takes all of one man's time, at \$1.75 per day, keeping the drills in repair, or practically \$2.00 per month per drill. The parts used in making repairs are all bought of the manufacturers. We see that the total cost of drill repairs has been about \$7.40 per drill per month, or 30 ct. per drill per 10-hr. day, which is a very moderate cost, and speaks well not only for the make of the drills, but for the care given to them.

Mr. J. B. Lippincott, in *Engineering News*, April 22, 1909, states that the cost of repairs to 3 Leyner No. 9 drills in gneissoid granite on the south end of the Elizabeth tunnel, averaged, during three months, 47 ct. per drill per lin. ft. of tunnel or about 11 ct. per drill per cu. yd. of rock.

Cost of Percussive Drill Repairs in Washington Tunnel Work.* For information regarding the cost of drill repairs on tunnel work, I am indebted to Mr. Chas. H. Swigert. The work was that of driving two tunnels on the Tieton Project of the U. S. Reclamation Service, near North Yakima, Washington. Two Wood drills were used, one in each heading.

Compressed air was used to operate the drills, one drill working in each heading. The North Fork tunnel was 3,811 ft. long

* *Engineering and Contracting*, Oct. 14, 1908.

and of 7 ft. 3 in. in diameter. The material through which the tunnel was excavated was a broken basaltic rock, about one-third of the material being very blocky basalt with clay seams, inclined to overbreak beyond the neat section of the tunnel. In all, 8,601 cu. yd. of material were excavated. Work was begun in the tunnel July 20, 1907, and the two headings met Aug. 13, 1908, the time consumed being 13 months. This meant a monthly progress from the two headings of 293 ft. One drill was used in each heading.

The Tieton tunnel was 2,929 ft. long and 7 ft. 3 in. diameter. About two-thirds of the material was very hard basaltic rock, breaking well, the rest being basaltic boulders and clay. The number of cu. yds. excavated from this tunnel was 4,774, being about 1.6 cu. yd. per lineal ft. The drills were installed on Aug. 4, 1907, and the two headings met May 20, 1908, the time being 9½ months, making a monthly progress in the two headings of 287 lin. ft.

The number of drill shifts worked in the North Fork tunnel, of 8 hr. each, was 1,330, while in the Tieton tunnel 932 drill shifts were worked. The drills sunk about 65,400 ft. of holes, making an average of 29 ft. of hole per 8 hr. drill shift.

There were 10 ft. of drill holes drilled for each lineal foot of tunnel, and 5 ft. of hole drilled for each cubic yard of excavation. The drills used were all of 3-in. size.

The cost of maintaining the four drills for this work and period of time (2,262 shifts of 8 hr.) was as follows:

Labor	\$372.78
Material	915.60
Total	\$1,288.38

It must be remembered that the wages paid in this section of the country are high, while the work was a long distance from the base of supplies, thus adding to the cost of materials.

The cost of maintaining the drills per lineal foot of tunnel, per lineal foot of hole and per cubic yard of excavation was as follows:

	Per ft. of Hole.	Per cu. yd. Excavation.	Per lin. ft Tunnel.
Labor	\$0.006	\$0.028	\$0.057
Material	0.014	0.068	0.140
Total Repairs	\$0.020	\$0.096	\$0.197

The cost of drill repairs was therefore 58 ct. per drill per 8-hr. shift.

Although labor conditions were generally good on this job, some trouble was experienced in obtaining competent drill runners, with the result that inexperienced men were used at times, which

was naturally harder on the drills. At the end of the job the drills were in good condition.

Consideration must also be given to the character of the excavated materials. The rock was very hard, yet seamy, and some of it was blocky, all causing extra wear on the drills. Yet the maintenance costs under the conditions worked are very low, the repair work being done in the field and not in a well rigged shop, and there being but four drills to maintain.

Cost of Repairing Air Hammer Drills and Percussive Drills. From data collected by personal visits to and special reports from a large number of tunnels, Messrs. D. W. Brunton and J. A. Davis, in Bulletin 57, Bureau of Mines, present the following statement:

From September, 1905, to March, 1906, hammer drills were employed at the Gunnison tunnel with a drill-repair cost per machine of 13 ct. per ft. of hole drilled; but when percussive drills were substituted the repairs were reduced to 3 ct. per ft. In addition to the cost of materials these figures include also a charge for the labor of the machinist making the repairs, a charge which is not embraced in any of the costs which follow. This fact must be considered in making comparisons.

Two years later (September, 1907, to August, 1908), in driving the last 3,000 ft. of the Yak Tunnel, the cost of materials only for repairs to the hammer drills employed was only 1¾ ct. per ft. of hole.

At the Marshall-Russell tunnel, where hammer drills were employed, the average cost of drill repairs from June, 1908, to June, 1911, was 1½ ct. per ft. drilled.

Percussive drills were used at the Strawberry tunnel from January, 1909, to September, 1911, the cost for repairs being nearly 2½ ct. per ft. drilled.

On the Little Lake division of the Los Angeles aqueduct, where hammer drills were employed, the average cost of drill-repair materials from July, 1909, to May, 1911, was only 24 ct. per lin. ft. of tunnel excavated. As each of the two machines in the heading drills approximately 8 ft. of hole for every foot of tunnel excavated the cost per machine per foot of hole is 1½ ct.

For 1910 and the first half of 1911 the repair cost of hammer drills at the Carter tunnel was 2 ct. per ft. drilled.

At the Lucania tunnel the repairs cost ½ ct. per ft. drilled, but the hammer drills had been in use only one month at the time the tunnel was visited.

The hammer drills at the Rawley tunnel were new also, the repairs for June and July, 1911, averaging 1 ct. per ft. of hole.

Cost of Drill Repairs on 3 Jobs. Dana and Saunders, in "Rock

Drilling," give the following data on percussive drill repairs:

No. 1:—On the Livingston Improvement of the Detroit River (in 1908–1909), an average of 10 Rand air drills ($3\frac{1}{4}$ by 7 in. cylinder) were actively engaged for 1,000 shifts (8-hr.) and the repair cost was \$9,765, or \$1 per drill per shift per active drill. Each drill averaged per 8 hr. shift about 45 ft. of hole, 13 ft. deep in limestone. Time studies showed that about 55% of the time was spent by a drill in actual cutting, 21% in changing bits and pumping sludge, 16% in moving from hole to hole, and 7% in miscellaneous delays. Two 8-hr. shifts were worked daily.

No. 2:—On D. L. & W. Ry. work (1909) near Hopatcong, New Jersey, Jas. A. Hart & Co., contractors, used 14 Ingersoll-Sergeant steam drills ($3\frac{1}{2}$ by 6-in. cylinder). The drills worked one 10-hr. shift daily, and averaged 39 ft. of holes per day, 20 ft. deep in hard limestone. In 13 months the repairs on 14 drills cost \$696, but just prior to beginning work 9 of the drills were completely overhauled at a cost of \$1100. The sum of these two items (\$1,796) is equivalent to about \$0.40 per drill shift.

No. 3:—In the crushed limestone quarry of the Brownell Impr. Co., Thornton, Ill., 14 Ingersoll air drills (13 D. F. A.) were used, 2 of the drills being spares. The company's records showed that during the first 9 months of 1909, drill repairs had cost \$3058, or \$0.93 per drill shift. Each drill averaged 29.3 ft. of hole per 10-hr. day. The holes were unusually large in diameter; the vertical holes being $5\frac{5}{16}$ in. in diameter at the top, $4\frac{1}{2}$ in. at the bottom, and 26 ft. deep; the inclined "toe holes" being $4\frac{1}{8}$ in. at top, $3\frac{3}{8}$ in. at bottom, and 12 ft. deep. A time study indicated that 67% of the drill time was spent in cutting rock, 18% changing steels, 5% moving from hole to hole, and 10% in miscellaneous delays.

An African Contest Between Air Hammer and Percussive Drills. I am indebted to a paper by Mr. J. Orr in the *Journal of the Transvaal Institute of Mechanical Engineers* (Abstract in *Engineering and Contracting*, July 1, 1908) for the following data relating to a contest held at the Robinson Mine, Africa.

Each contestant did 1 hr. drilling in granite blocks designated as A, B, and C, and 1 hr. dry drilling in block D, with a 15 min. pause between trials. The first day's trials were at a pressure of 50 lb. and the second at 60 lb. per sq. in. The flat faces A, B, and C were set at an angle of 25 degrees from the vertical, and the face of D vertically. Holes were drilled perpendicular to the faces and at an angle 10 degrees above the horizontal to represent *stopping, sinking and driving*. The blocks were of granite of *uniform hardness*. On the underground work not more than 60 steels per drill were permitted per man. Steels were of *star or cross type, or chisel hits*.

The underground tests consisted in drilling 8 down holes, at the angle of the reef, on the first day, and 8 up holes also at the angle of the reef on the second day, both tests to be carried out at a constant air pressure of 60 lb. per sq. in.

The twelve competitors taking part in the forty-eight 4 to 6-hr. trials were as follows:

Drill	Weight, Lb.	Type	Cylinder diam., in.	Stroke length, in.	Feed length, in.	Notes
Kimber	100	Hammer	3%	3	12	Air Jet
Climax	Little Wonder			6	16	Air Jet
Tappet	118.5	Percus.	2			
Grose						
Kid	102.5	Percus.	2	5	18	Solid Steel
Holman	97.5	Percus.	2	5	16	Solid Steel
Hardeocg	Wonder 44.2	Hammer	1.8	1%	18	Air & Water Jet
Gordon	72.6	Hammer	1 3/16	10	20	Air & Water Jet
Flottman	52.2	Hammer	2%	1%	24	Solid Steel
Baby Ingersoll	129.5	Percus.	2%	5	15	Solid Steel
Chersen	113.6	Percus.	2%	6	18	Solid Steel

On the basis of inches drilled per pound weight for a period of 4 hr. the following was the order:

Name of Machine.	Air Pressure.	
	50 lb. per sq. in.	60 lb. per sq. in.
	Ins.	Ins.
"Gordon"	4.69	6.08
"Flottmann"	4.33	5.83
"Chersen"	2.79	3.50
"Baby Ingersoll"	2.34	2.74
"Little Kid"	1.85	2.63
"Holman"	1.77	2.09
"Little Wonder"	1.68	2.02
"Kimber"	1.55	2.03

It has frequently been urged against the hammer type, and insisted on strongly by certain competitors, before the trials began, that the sticking of the steels in the holes was the fatal objection to the hammer type of drill. The "Gordon" drill has entirely disproved this statement, and has conclusively shown that if sticking occurs it is the fault of the operator. The records of the "Gordon" drill show the following holes to have been drilled:

	Holes.
On surface	.24
Underground	.16
By kaffir subsequent to contest	.12
Total	.52

Requiring a total of 208 steels.

The conditions of the contest did not provide for the measurement of air. Certain rough observations were made during the trials, sufficient to indicate that there existed a wide diversity in

the air consumption. For example, it was perfectly evident that the drill which takes second place was using at least $2\frac{1}{2}$ times the air required by the winning drill.

Unfortunately no definite record of the strokes per minute was made, as such was not called for by the conditions, but the approximate figures are given:

Name of Drill.	Piston or hammer displacement of air per minute.	
	at 50 lb. pressure.	at 60 lb. pressure.
	cu. in.	cu. in.
"Gordon"	5,617	6,771
"Little Kid"	6,782	7,928
"Holman"	7,065	8,321
"Little Wonder"	8,460	9,964
"Flottmann"	10,395	12,166
"Baby Ingersoll"	10,945	12,736
"Chersen"	18,868	20,648
No. of strokes per minute of "Kimber" drill not ascertained.		

The following table gives the average result of drilling in four blocks of granite:

Name of Drill	Depth drilled at 50 lb. air pressure.	Depth drilled at 60 lb. air pressure.	Percentage increase in depth drilled at 60 lb. pressure.
"Kimber"	12 ft. 11% in.	16 ft. 11 in.	36.6
"Little Wonder"	16 ft. 7% in.	19 ft. 11% in.	19.7
"Gordon"	28 ft. 4% in.	36 ft. 9% in.	29.5
"Little Kid"	15 ft. 9% in.	22 ft. 6% in.	42.6
"Baby Ingersoll"	25 ft. 3 in.	29 ft. 6½ in.	17
"Flottmann"	18 ft. 19% in.	25 ft. 4% in.	34.4
"Little Holman"	14 ft. 4¼ in.	17 ft. 0¼ in.	18.6
"Chersen"	26 ft. 5% in.	33 ft. 2 in.	26.0
Mean percentage increase			27.3

The following table gives the mean results of two trials with a Gordon hammer drill; the mean being the average of the drilling in granite blocks A, B, C and D; trial No. 1 at 50 lb. air pressure; trial No. 2 at 60 lb. air pressure.

	Trial No. 1	Trial No 2
Time to fix arm in approx. position and tighten up	11.5 sec.	12.5 sec.
Time to place machine in position on clamp	9.5 "	10.7 "
Time to put on air hose	7.0 "	10.7 "
Time to place steel in chuck	2.25 "	5.5 "
Time to adjust steel to required angle	48.0 "	1 m. 1 "
Time taken to start machine after given signal	1 m. 31 "	1 m. 43 "
Diameter of starting bit	1% "	1% "
Time of drilling with starting bit	41.25 sec.	33¾ sec.
* Depth drilled with starting bit
Time taken to change steel	3.25 "	6.25 "
Time elapsing between stopping and restarting	12.25 "	10.7 "
Diameter of first steel	1% "	1% "
Time of drilling with first steel	4 m. 46¾ sec.	3 m. 3 sec.
Depth drilled with first steel	69¼ "	51½ "
Rate of drilling with first steel, ins. per min.	1.37 "	1.94 "
Time taken to change steel	3 sec.	4.7 sec.
Time elapsing between stopping and re-starting	14.5 "	14.7 "
Diam. of second steel	1% "	1% "

* First steel used for facing only in both trials.

	Trial No. 1	Trial No 2
Time of drilling with second steel	6 m. 14 $\frac{1}{16}$ sec.	4 m. 30 sec.
Depth drilled with second steel	9% "	81 $\frac{5}{16}$ "
Rate of drilling with second steel, ins. per min	1.45 "	1.99 "
Time taken to change steel	4 sec.	6.7 sec.
Time elapsing between stopping and re-starting	29.75 "	18.5 "
Diameter of third steel	1 $\frac{1}{4}$ "	1 $\frac{1}{4}$ "
Time drilling with third steel	6 m. 18% sec.	4 m. 24 sec.
Depth drilled with third steel	10% "	105 $\frac{1}{16}$ "
Rate of drilling with third steel, ins. per min.	2 $\frac{3}{8}$ "	2.34 "
Time taken to change steel	7.5 sec.	8.7 sec.
Time elapsing between stopping and re-starting	26% "	26.7 "
Diameter of fourth steel	1 $\frac{1}{2}$ "	1 $\frac{1}{2}$ "
Time of drilling with fourth steel	7 m. 32 $\frac{1}{4}$ sec.	6 m. 10.7 sec.
Depth drilled with fourth steel	14% "	15% "
Rate drilling with fourth steel, ins. per min.	1.95 "	2.57 "
Total depth of hole drilled	40% "	41 $\frac{1}{32}$ "
Total time for hole	28 m.	21 m. 41 sec.
Total actual drilling time	25 m. 33 sec.	18 m. 41 sec.
Percentage of actual drilling time is of total time	91.2%	86.6%
Depth drilled per min. of total time	1.47 "	1.89 "
Depth drilled per min. of actual drilling time	1.6 "	2.2 "

The original article gives the results of similar trials of the other makes of drill.

A Test of An Air Hammer Drill. A test was made in 1908 of a Sullivan air hammer drill D-21 at Cobalt, Ont.

The hole was a dry back hole, in a drift, and was in hard conglomerate rock all the way. Drill was set up on a tie in the track. The time taken to set up, after connections were made, was 20 sec. The time consumed from the starting of drilling till the test was completed was 18 min. The length of hole drilled was 5 ft. 4 $\frac{1}{2}$ in.

Five pieces of drill steel were used and the time for each was as follows:

	Min.
1st drill	4
2nd drill	3
3rd drill	4
4th drill	4
5th drill	3
Total	18

The time consumed in changing drills is included in above and was from 15 to 20 sec. for each change. The cutting fell from the hole in a steady stream and the air in the vicinity of the drill was not so dusty as would have been the case with an ordinary percussion drill.

In granite in the quarries at Barre, Vermont, a Sullivan foot hole drill, class D-19, using hollow drill bits and weighing 30 lb., manufactured by the Sullivan Machinery Co., of Chicago, was used. The diameter of the cylinder of this drill is 1 $\frac{1}{4}$ in., and it used 25 cu. ft. of air per minute at 100 lb. pressure. This drill can be used in drilling holes up to 1 $\frac{5}{8}$ in. diameter and 4 ft. deep.

Air is admitted by a push handle throttle, which is opened when the runner presses the drill against the rock, and closed when this pressure is relieved. The hole is cleaned by the exhaust air, which passes through the drill steel, and is kept true and round by rotating the steel with a handwrench.

This plug drill made a record of drilling a number of holes 12 in. deep and $1\frac{1}{4}$ in. in diameter, in an average time of 1 min. 45 sec. The best time for a single hole was 1 min. and 30 sec.

Upon another occasion in the same granite quarries a Sullivan plug drill, class D-15 $\frac{1}{4}$, drilled several holes $\frac{5}{8}$ in. in diameter. One of these, 5 $\frac{1}{4}$ in. deep, required 15 sec. to drill, while another 4 $\frac{5}{8}$ in. deep was drilled in 10 sec.

One man with a plug drill does as much work as 2 or 3 men hand drilling.

Comparative Speed of Hand Churn and Air Hammer Drilling. Mr. B. B. Brewster in *Mine and Quarry*, Aug., 1913, describes the use of hammer drills in sinking a hoisting shaft and an air shaft, each 17.5 x 11.5 ft. to a coal seam, 631 ft. below the surface, at Nokomis, Illinois. The material was an upper capping of hard rock with shale of varying hardness beneath. The shale at times consisted of slaty bands, sandy shale, or soft gray material like indurated clay, and had an occasional layer of limestone 10 or 12 ft. thick. In sinking, from 28 to 32 holes, 4.5 ft. deep, constituted a round. Eight Sullivan "DB-19" hand hammer drills, each weighing 40 lb. were driven by air supplied by a Sullivan single-stage steam driven compressor, size 9 x 10 x 12, providing 174 cu. ft. of free air per min. at a pressure of 100 lb. The steel used was hollow, with exhaust air discharge, and six-point rose bits.

In drilling through the shale the tools cut so fast as to choke the hole in the bit with muck, preventing the passage of exhaust air and proper cleaning of the drill hole. Hand drilling was temporarily substituted until the machines had been altered. The gage of the bits was increased from 2 to 2 $\frac{1}{2}$ in. for the 3-ft. length and from $1\frac{7}{8}$ to 2 $\frac{1}{4}$ in. for the 6-ft. length. Later 3 steels of the following sizes were used: Starter, 2-ft. long, 2 $\frac{3}{4}$ in.; No. 2, 4-ft. long, 2 $\frac{1}{2}$ in.; No. 3, 6-ft. long, 2 $\frac{1}{4}$ in. The wide gage gave large openings between the wings of the bit and allowed free escape of the air. A device for holding the drill steel fast to the tool was added. This permitted the operator to move the drill, bit and all, with the piston running, up and down in the hole, thus keeping it cleaner. The holes were also *kept full of water*. The following costs of air hammer drilling in soft shale are for the drills with these changes.

Three shifts of 8 hr. each were worked in each shaft. Drillers

and muckers received \$3.39 per shift and shift leader, \$4, making a total labor cost per day, for both shafts, of \$93. Four drillers with the hammer drills made 18.9 ft. per man per hour, and with 2¼-in. hand churn drills made 4½ ft. per man per hour. The machine drills made a round of 54 ft. in 45 min. and the hand drills a round in 3 hr. The total rate of sinking shaft per day (3 shifts) was 4.5 ft. with the machine drills and 3.5 ft. with the hand drills. The saving by the air hammer drills was \$53 per 24 hr. on two shafts.

Cost of Air Hammer Drilling with Portable Gasoline Driven Compressors. In Gloucester, Mass., in solid granite formation and in boulders of glacial origin, a Sullivan portable gasoline driven compressor was used on street work. This machine operated Sullivan Class DB-15 and DB-19 hammer drills. This outfit has proved well adapted for such work as widening out streets, excavating trenches, etc. It is also used in the City quarry for excavating stone for the quarries.

Mr. Samuel Seaver, in *Mine and Quarry*, July, 1910, gives records of work with portable compressors and air hammer drills. Records kept on the classes of work described above show that the hammer drills are doing about three times as much work as the tripod percussive drills formerly accomplished. The cost of operation for the drills and compressor is about one-third less than that of the steam drills and boilers. Some of the performance records of the hammer drills are worthy of note. In 16 hr. time, the DB-15 drill put in 47 ft. in 25 holes, ranging from 19 to 36 in. deep, and the DB-19 drilled 19 ft. or 5 holes running from 32 to 60 in. in depth. This includes loading, shooting and all details, and further the drills were not operated at the same time. Holes 5 ft. deep have been drilled frequently in 30 min., and the best time noted for a hole of this depth is 20 min. This drilling was done in very hard dark green bastard granite.

Another instance of the convenience of these portable air compressors and drill outfits was furnished by the Keystone State Construction Company of Yonkers, New York, in the building of a reservoir for the Board of Water Supply of New York City.

The ground was heavily covered with boulders, which it was necessary to remove from the basin, and the contractors broke these up as removed, for use in concrete. At first this work was done by hand at a cost of \$1.50 per man per day. As each man was able to drill about 5 ft. of block hole per day, this showed a cost of 30 ct. a ft. for drilling.

The contractor finally installed a Sullivan portable compressor outfit of the size and type described above, together with three Sullivan DB15 hammer drills. These tools drilled an

average of 50 ft. each day. The cost of operation is estimated as follows:

3 drill operators at \$3.50 per day	\$10.50
Compressor attendant	3.50
Gasoline, per day, 15 gal. at 20 ct.	3.00
Interest, renewals, wear and tear	6.00
Total cost per day	\$23.00

\$23 divided by 150 gives a cost of 15½ ct. per ft. of hole, which means a saving of 14½ ct. per foot over hand work, or \$21.75 per



Fig. 45. Portable Drilling Outfit, Sullivan Machinery Co.

day. The saving at this rate will rapidly pay for the equipment and of course secures greater speed.

Air Hammer Drills in New York. According to *Engineering News*, Aug. 19, 1915, 2 and sometimes 3 jackhammer drills were driven by a gasoline air compressor of a capacity of 150 cu. ft. of free air per minute, for drilling 8-ft. holes in Manhattan schist. The drill steels were made in 2, 4, and 8-ft. lengths, with the starter 2 in. in diameter and were gaged ¼ in. between changes. *Six-point bits were used as being less likely to stick in the seams. With a 60-lb. air pressure, the actual drilling time for an 8-ft.*

hole in sound rock was about 40 minutes; 10 holes were a good day's work.

Cost of Drilling with Electric Drills. Some of the advantages of the electric drill as compared with a steam or compressed air drill are as follows:

- (1) Low first cost of plant.
- (2) Ease of installation.
- (3) Economy of power.

Some of the disadvantages are:

- (1) High cost of maintenance.
- (2) Time lost incidental to breakdowns.

In a test of 2 Adams electric drills and 2 old 2 $\frac{3}{4}$ -in. air drills operated at 80-lb. pressure at sea-level, the results were as follows, according to Mr. Granville E. Palmer, in *Engineering and Mining Jl.*, Aug. 18, 1906. The rock was black diabase, and the work was done during 53 consecutive 10-hr. shifts.

	Air drill.	Electric drill.
Actual hours drilling	317	100
Actual feet drilled	1279	253
Average feet per hr.	4	2.55
Times stopped for repairs	0	17

Mr. Bery B. Lawrence states (*Eng. and Min. Jl.*, Oct. 6, 1916) that Siemen-Halske electric drills were a failure in "fissured" and "vuggy" ground.

The Dulles-Baldwin electric drill was tested in the trap and granitoid gneiss of the Catskill pressure tunnels with the following results, according to *Engineering and Contracting*, Nov. 12, 1913. Measurements of 24 holes showed an average speed of drilling 6.1 ft. per hr. The feet per drill hour made in drilling an average heading was less than this on account of the time lost in breakdowns. The average over a period of five weeks, when the drills were working at their best, was 5.3 ft. per hr. A full shift of 8 hr. was required to drill a heading with five drills, for though some of the drills finished in less time, it happened that one or two lost considerable time through breaking of parts. The average depth of the shaft sunk per shift of 8 hr. was 0.8 ft. The power input at the motor is 4 kw. Allowing 80% efficiency for the motor, the power transmitted to the drill is 3.2 kw. or about 4.3 hp.

The number of breakdowns was greatly reduced by improvements in design and change of material. It was necessary, however, to overhaul the drill each day. The principal sources of trouble were as follows: Grounding of motors which occurred in shafts where there was water. Burning out of armatures due to excessive moisture did not occur after a new and improved insulation was applied to the armatures. Short circuits in leads were largely eliminated by improved connections at motor.

Stripping or breaking of gear teeth happened when the steel stuck in the drill holes, one tooth perhaps breaking off and then grinding in the gears. Shearing stud bolts holding gear to crank shaft was due to the same causes as stripping. Breaking guide shells or drill case was eliminated by making these parts of cast steel instead of cast iron. Breaking of cylinders was reduced by making cylinder and crank out of one piece. Breaking rotation mechanism was reduced to some extent by a new form of spring. Loss of compression in cylinder was due largely to loosening of nut at end of cylinder. Troubles of this kind were claimed to be due to a brass sleeve holding nut expanding more than the steel cylinder and allowing the nut to loosen. Heating of drill was prevented by proper lubrication. The loss of compression and failure of the rotation mechanism were the chief causes of trouble.

A description of an electric rock-drill installation at the iron mines at Peine Hanover, Germany, is given in *Glückauf*, June 4, 1904.

"The installation referred to comprises 10 electric percussion Siemen-Halske rock drills, driven by 215 volt three-phase motors.

"The primary plant consists of a 10 kw. three-phase generator driven by a gas engine using blast-furnace gas. The current is generated at 1,000 volts, and is transformed to 217 volts in the mine.

"It has been found essential for the efficient working of these electric drills to give them frequent and careful inspection in order to make certain of even the smallest part being in good working condition.

"Apart from this the drills seem to have given good results, and the repairs necessary have been by no means heavy. The most troublesome part appears to have been the crank-pin, but it is now the practise to replace it after 50 hr. work. Another weak spot is the spring used, and it was found that the average life of a spring is from 30 to 33 shifts.

"The consumption of energy per drill amounts to 5.5 amperes at 220 volts, so that the 10 kw. generator, stationed over a mile from the mine, is large enough for 6 drills.

"The cost of one drill complete with wall box, flexible shaft, motor, cable, column, and 125 bits amounts to about \$1220, and as two drills were used in one shaft the total cost was \$2440, plus \$80 for a tool case, or \$2520.

"The working expenses for the year 1901, to May 31, 1902, were as follows, there being two drills constantly in use:

Cost of energy	\$ 55.20
Spare parts	309.60
Wages of fitters	194.40
Materials	112.80

Blacksmiths' wages	175.20
New drills and drill sharpening	\$189.60
Interest on capital and depreciation on 6 drills, share of switch board, water supply, etc.	600.00
Total	\$1,636.80

“The work done during the year amounted to 1,652 drill shifts, or a cost per drill per shift of \$0.99. From June 1 to Nov. 30, 1902, 7 drills were in use, and the cost per drill per shift amounted to \$0.88, including all the items previously mentioned, along with lubricating oil, waste, etc.”

Mr. H. W. Appleby (*Engineering Journal*, Oct. 12, 1907) stated that in iron-ore mining at Cleveland, Yorkshire, England, an air compressor, working six 3½-in. air drills, was consuming an average of 111 hp. This engine was replaced by an electric generator and six electric rock drills. With these drills breaking as much rock as the old drills, the new engine showed only 24.5 hp., a reduction of 80% in power used. Drilling cost per ton in cents:

	Air.	Electric.
Oil, stores, and labor	0.594	0.506
Coal	0.484	0.216
Repairs, making and sharpening drills, and maintenance of pipes or cables	0.680	0.340
Total	1.758	1.062

The Fort Wayne electric drill was tried out on the pressure tunnel of the Catskill aqueduct in trap and granitoid gneiss, and while it proved to be very rugged and required practically no repairs, it did not have power enough to cut the rock encountered, and was soon abandoned (see *Engineering and Contracting*, Nov. 12, 1913).

Mr. Wm. Magenau (*Engineering and Mining Journal*, June 6, 1903) states that he had operated eight drills of the solenoid type (Marvin) for two years, running night and day. They gave good service as far as constancy was concerned, and their mechanism was simple and easily handled. In hard limestone, seamy and full pockets, they made 25 ft. per 10 hr., whereas air drills made 45 ft. per 10 hr. on the same work. The weak point of a solenoid drill is its small pulling power after the blow has been struck.

I am indebted to Mr. J. B. Hobson, Manager Caribou Hydraulic Co., Bullion, B. C., for the following cost data as of 1904: Four Gardner Electric Drill Co.'s No. 15 drills, with 2 hp. motors, and one "B" drill with a 1½ hp. motor, have been used for two years by Mr. Hobson with excellent results. Each of the larger drills has averaged 13 holes, 8 ft. deep, in firm augite diorite and porphyrite, per 10-hr. shift. The starting bit is 2½ in. and the finishing bit 1½ in. in diameter. The cost, per 10-hr. shift, of operating three drills has been as follows:

1 cord of wood	\$2.25
1 electrical engineer	4.00
3 drillers, at \$4	12.00
3 helpers, at \$2	6.00
1 blacksmith	4.00
1 blacksmith's helper	2.00
3 bu. charcoal75
Oil55
Total for 3 drills, 312 ft. drilled	\$31.55

The cost of drilling, including sharpening, but excluding repairs, interest and depreciation, was 10 ct. per foot of hole. See page 34 for cost of hand drilling in the same rock.

In *Trans. Am. Inst. Min. Eng.*, 1903, Mr. Frank E. Shepard describes the Box electric drill which is manufactured by the Denver Engineering Works, Denver, Colo. The drill steel is not churned but is struck by the piston, resembling the Leyner drill in this respect. Water is forced down through a pipe which slips over the drill steel, and the sludge is washed out of the hole. In drilling a block of granite from Platte Canyon, Colo., an electric current of 11 amperes at 110 volts was used, which is equivalent to 1.62 hp. A hole $2\frac{1}{4}$ in. in diameter was drilled, the first 16 in. being drilled in 7 min.; then 1 min. was consumed in changing bits. The next 14 in. were drilled in 5 min., and 1 min. more was consumed in changing bits. The last $3\frac{1}{2}$ in. were drilled in $\frac{3}{4}$ min. The rate for the full $33\frac{1}{2}$ in. was 2.23 in. per minute. In tunnel work in Boulder County, Colo., one machine drilled $12\frac{1}{2}$ ft. of holes (number of holes not given), $\frac{2}{4}$ in. diam., in hard granite in 2 hr. Three tunnel holes, each 5 ft. deep, were drilled in $2\frac{1}{2}$ hr. In shaft sinking at the Ophir Mine, Anaconda, Colo., five 4-ft. holes were drilled in $3\frac{1}{2}$ hr. In the tunnel of Imogen Basin Gold Mines Co., Ouray, Colo., four holes 5 ft. deep were drilled in 3 hr. in soft rock with mud slips running through the seams.

Mr. H. P. Barnes states (*Engineering and Mining Journal*, Sept. 15, 1906) that the small stoping size Box drill weighs about 140 lb., and that the large size, which is equivalent to a $2\frac{1}{2}$ or 3-in. air drill, weighs 280 lb. In a 2-in. hole in hard granite a Box drill made 2 to 3-in. per min. with an expenditure of about $1\frac{1}{2}$ hp.

Mr. Wm. H. Yeandle, Jr. (*Engineering and Mining Journal*, Oct. 27, 1906) says he has used three Box electric drills, two actually working and one being held in reserve. The two working drills were run two 12-hr. shifts daily except Sunday by Mexican labor. The rates of wages were \$3.25 (Mexican) for drillers and \$1.75 (Mexican) for helpers, per day of 12 hr. One mechanic and helper did all the repair work, receiving \$5 (Mexican) per 12-hr. The rock was highly metamorphosed lime shale, pyroxene andesite and quartz vein-filling and was very hard. The workings were hot and foggy.

Each drill put in one round of 16-ft. holes in 24 to 28 hr., the drill being "torn down," the holes fired, the rock mucked, and the drills reset in 8 to 12 hr., thus making an advance of 4 ft. per 36 hr. in a 5 x 6-ft. drift or cross-cut. The drills seldom fitchered. The cost of repairs due to the vibration and heating of motors and the excessive wear on those parts of the drill which transmitted the turning motion to the chuck-blocks, was very high. However, the inefficient labor made hand drilling cost from 37 to 50 ct. (Mexican) per ft., and the electric drills showed a saving.

Cost of Operating and Maintaining Electric Air Drills. Mr. Wallace F. Disbrow (*Engineering and Contracting*, Dec. 23, 1908), mining engineer and superintendent of the Merry Christmas Lead and Zinc mine, has furnished the following data on operating two Temple-Ingersoll electric air drills. These drills are of the 4D size, having a cylinder $4\frac{3}{4}$ in. in diameter and a 7-in. stroke. The drill is designed to carry 10 ft. of steel in drilling vertical holes. This makes the work done similar to that of a $2\frac{3}{4}$ -in. steam or air drill. The motors used on these drills were from 3 to 5 hp., the former being used on low speed and the latter on high speed.

The two drills were operated for six months at the time the data were collected, in soft limestone formation. Although the rock was soft, it was exceedingly sticky and a heavy, grimy paste was formed. In fact, with 80-lb. pressure on the old style air drill it was very difficult to put down and extract a 6-ft. steel even when the hole was well watered. The electric air drills, with their powerful plunging stroke, handled a 12-ft. steel down to the chuck without a stop if the machine was properly handled. In fact it was noted that when the hole was not sufficiently watered, the steel would still go down and keep turning so that when the hole was finished it would be almost impossible to extract the steel with a wrench.

This long stroke is an important factor in drilling holes wherever the sludge forms quickly, as the drill point thus helps to keep the bottom of the hole free of the sludge. With a short stroke the sticky sludge hangs much closer to the bottom of the hole, cushioning the blow, and sometimes stopping the drill. To keep the hole well watered in either case is a great help to the drill.

The drills in the Merry Christmas mine are not used continuously. Upon one occasion one drill put down 63 ft. of hole in two hours, the average depth of holes being 5 ft., making a record of $31\frac{1}{2}$ ft. per hr. On another day a drill sunk two rounds of 12 holes each, to an average depth of 5 ft. For this work the drill was set up twice, as each round of holes were shot. This meant the drilling of 120 ft. of holes, the time being $5\frac{1}{2}$ hr., or at the rate of 21.8 ft. per hr., including making the extra set up.

The cost of maintenance of these two drills for six months has been about 20 ct. per day per drill. The principal parts to wear were chuck bushings, hose, front head cup leathers and chuck pins. The hose is the largest item of renewals; as soon as the slightest leak appears it must be discarded.

The cost of electric power for these drills has been \$1.00 per day per drill, power costing 5 ct. per kw. hr.

Mr. W. L. McLaughlin, general manager of the Mogul Mining Co., of Deadwood, S. D., gives the following information regarding the working of an Ingersoll-Temple electric air drill. The drill strikes a very powerful blow, and, for this reason, the bits are blunter or thicker to avoid breakage. The drill used by the Mogul Mining Co. was a No. 4D. For this type of machine a 4 hp. motor is used. The machine is adapted to drilling vertical holes to a depth of 10 ft. Its work will compare favorably with a 2¾ in. diameter steam or air drill.

During the month of June, 1908, the Mogul Mining Company used this drill for cross cutting work in their mine. During the month the drill was worked for 99 hr. After the first 20 days' work a new man was put to running the machine, with the result that for 3 or 4 days less work was done by the machine, but after that he was able to operate it at the average of the drilling record. In all, 555 lin. ft. of hole were drilled. This gives a rate of 5.6 lin. ft. per hour.

The cost of operating the drill was as follows:

1 miner, 99 hr., at 50 ct.	\$49.50
1 helper, 99 hr., at 25 ct.	24.75
Total	<u>\$74.25</u>

A miner and his helper operated the machine. This gives a cost of 13.4 ct. per ft. The cost for the power used is almost negligible, Mr. McLaughlin states, and for the conditions in their mine this machine effects a great saving over the drill run by the ordinary air compressor. The rock drilled was quite hard, and, considering the rates of wages paid, the cost is very reasonable.

The cost of maintaining the drill for the first 10 months was as follows:

New parts bought:	
6 springs	\$ 2.01
1 air gage	2.65
12 cup leathers	2.40
Fittings	10.25
Total	<u>\$17.31</u>
Labor	<u>39.00</u>
Grand total	<u>\$56.31</u>

For the first two months no repairs were made to the drill. The average monthly cost of repairs to the drill was \$5.63. This makes

a little over 1 ct. per ft. of hole drilled during June, as a charge for drill maintenance. This is a low cost.

The Brier Hill Collieries of Crawford, Tenn., have been using one of these drills, a 5D, in their mines for about 18 months for drilling holes in the roofs of several entries. The rock varies from slate to sandstone and conglomerate rock, and Mr. E. B. Taylor, general manager of the mines, states that the drilling was done through the hardest roof he had ever encountered in 30 years' mining experience.

A 5D drill is equivalent to an Ingersoll-Sergeant 3½-in. drill, and has a stroke of a little more than 8 in. It will drill a 16-ft. vertical hole from 1¾ to 2¾ in. in diameter. It has a 5½ hp. motor. Such a drill is intended for the heaviest work in large tunnel headings, open cut work in quarries or railroad grading, or in shaft sinking, or mining.

During 16 months' work with this drill, holes were drilled in the roof of the main entry of one mine, a distance of 600 lin. ft., in driving three entries of another mine, a distance of 250 ft. in a new haulway, 200 ft. in the 2d left entry, and 275 ft. in the 3d left entry.

These three entries were driven simultaneously, the drill being moved from one entry to another as it was needed. Only one hole was drilled in the roof of each of these entries each day, the average depth of a hole being 7 ft. It took the drill runner and a helper from 20 to 30 min. to unload the drill from a car and set it up, while the hole was drilled in about 20 min. About a half day was consumed in drilling the three holes and making the necessary moves, more than three-quarters of the time being taken up in moving and setting up the drill.

With wages for the drill runner at \$3.50 for a 9-hour day and \$2 for the helper, this gives a labor cost of 13 ct. per ft. of drilling. Upon one occasion the crew drilled 7 holes in a 9-hour shift, aggregating 42 ft. 6 in., which substantiates the cost of 13 ct. per ft. Mr. Taylor states that during the 16 months this work was going on, the repair cost was nominal.

The Superior Portland Cement Co., of Superior, Ohio, has three 5C size of these drills at work in their limestone quarries. M. J. B. John, manager of the company, gives the following account of work done by these drills.

The ledge of limestone averages about 8 ft. in thickness. To blast out this limestone, holes 6 ft. deep and 2½ in. in diameter are drilled. Each drill puts down, on an average, 17 of these holes per day. Thus three drills do 306 ft. of hole per day. There is blasted out on an average, 500 tons of limestone per day, equivalent to 220 cu. yd. This gives an average of 1.4 ft. of hole per cu. yd. of rock blasted, place measurement.

With wages for the drill runner at \$3.50 per day, and helper at \$2 per day, this gives a cost for labor for drilling of 5.4 ct. per ft., and 7.5 ct. per cu. yd. of rock blasted, which is a very low cost.

A factor that enters into the rapid work done by this drill is its strong back-pull stroke. Even when the steel binds, there is a pull and push on the piston, at full power, for every revolution of the pulsator; and this works it loose almost instantly. Mr. John states that the wear and tear on these drills has been very light.

The method of moving the pulsator and motor in the quarry was very simple. These two are mounted on a common bed which has two sets of wheels under it. A cheap wooden frame for a track was made in sections, for the truck to run on. Only a few of these sections were needed and they were light, inexpensive and easily handled. Small steel rails can also be made up in sections and used in the same manner, and naturally they will give better service, as well as allow of a better joint being made between the sections. When a good hard bottom occurs in the mine or quarry, the pulsator and motor can be moved from place to place without any track, the wheels running directly on the rock. On tracks it can be carried over rough ground or muck piles with the aid of blocks and tackle.

Mr. H. B. Barnes states (*Engineering and Mining Journal*, Sept. 15, 1906) that in drilling a round of holes in a breast of iron and zinc sulphide with a Temple 5A electric air drill, the following results were obtained:

Hole No.	Cutting Speed.	Power.
1st steel	4½ in. per min.	4 hp.
2nd steel	7 in. per min.	3½ hp.
3rd steel	8 in. per min.	4 hp.
4th steel, 7 ft. long	7 in. per min.	4 hp.

In drilling a 5-ft. hole where the steel stuck several times because it was under gage, 25 min. were consumed. A 5-ft. 4 in. hole 2 in. in diameter, was drilled in 15 min. including the time lost in changing steel 3 times.

Mr. Chas. A. Chase stated (*Engineering and Mining Journal*, Sept. 22, 1906) that he tried several makes of electric machines for use in narrow drifts and cross-cuts of the Liberty Bell Gold Mining Co.'s property at Telluride, Colorado, without success. The Temple drill was successful, the cost of repairs being hardly more than of the standard machine. The power consumption was 5 hp. per electric drill. At 10,400 ft. elevation, running two compressed air drills, the motor input at the compressor was 50 hp.

The work accomplished was about 50 to 60-ft. of hole drilled, loaded and shot by the electric-air drill crew, and about the same footage drilled but not loaded and shot by the air drill men.

Mr. Chas. A. Hirschberg (*Engineering and Contracting*, Apr. 3, 1912) is authority for the statement that in a limestone quarry at Buffalo, N. Y., electric-air drills (5-C) made from 100 to 120 ft. of hole in 9 hr. Holes were started 2½ in. and bottomed 1¼ in. in diameter.

Speed of Drilling with Electric-Air Drills. The speed of drilling with electric-air drills at the Kensico (N. Y.) Dam is given by Mr. Frank Richards in *Compressed Air Magazine*, March, 1913, and by Mr. W. L. Saunders in *Bulletin, American Institute of Mining Engineers*, Feb., 1914. From these papers I have compiled the following data:

Drill: Temple-Ingersoll Electric-Air, Type 5-F.

Work: Quarry and dam foundation.

Rock: Gneiss, mainly hard and solid.

Shifts: One 8-hr. shift per day.

Length of Feed: 30 in. In practice about 25 in.

Strokes per min: 400 at full-speed.

Crew: One driller, one helper.

Drills moved: By crew, by hand.

Bits: Starter, 3½ to 4 in., decreasing by ⅛ in. to 1¾ in.

Steels: Octagonal, 1¼-1½ in.; 2 ft. 6 in. to 28 ft. 8 in. long.

Spacing of holes: 15 x 12 ft. to 20 x 20 ft. at quarry. Close spacing at dam.

Holes cleaned: By sand pump.

Drills sharpened: By Leyner machine at quarry; by hand, at dam.

Smith: 2 smiths sharpened drills and repair work.

Dynamite: 60% Du Pont dynamite. Averaging ½ lb. per cu. yd. of rock.

Blaster: 1 loader, 2 tampers.

Coal: Used by smith 500 lb. per day.

Oil: 3 quarts per drill per shift.

Cutting speed: At quarry, 0.14 ft. per min.; at dam, 0.19 ft. per min.

The time studies made by the Construction Service Co., showed the following averages:

	Quarry. Per cent.	Dam. Per cent.
Drill cutting	51.1	58.9
Raising drill	3.6	4.0
Loosening chuck	0.3	0.7
Removing bit	1.4	2.4
Bailing hole	3.4	6.8
Putting bit in hole	1.0	3.2

	Quarry. Per cent.	Dam. Per cent.
Inserting bit in chuck	1.4	1.7
Tightening chuck	2.2	1.1
Getting started	3.8	0.9
Total	68.2	79.7
Shifting to next hole	16.4	12.2
Miscel. delays	15.4	8.1
Total	100.0	100.0
Total time, min.	448	236
Cutting speed per min., while actually cutting	0.14	0.19
Total ft. drilled	31	26.4
Average depth of hole, ft.	22	11

One drill at the quarry drilled 31 ft. in 448 min., which is equivalent to 200 ft. drilled by 6 drills in 8 hr. The average spacing of the holes being 17.5 x 16 ft., the cubic yards loosened were 2,070. One drill at the dam drilled 26.4 ft. in 236 min. and, therefore, six drills would accomplish 320 ft. in 8 hr. The spacing being omitted it is impossible to compute the cubic yards loosened. The total drilling cost at the dam including interest and depreciation was about 15.8 ct. per ft.

Electric Air Drill-Wagon. Besides the tripod electric-air drills there were four electric-air "drill-wagons" on the Kensico Dam work. These were constructed somewhat on the same principle as is the auto-traction rock drill described on page 141. Each machine is entirely self-contained and is moved along upon a temporary track as the work proceeds. The drill has a vertical power feed of 6 ft. The machines drilled holes to a maximum depth of 30 ft., using a 5 or 5½ in. starting bit and a 4 or 4½-in. finisher. The average performance per machine was 45 to 65 ft. of hole in 8 hr., and the maximum performance under test conditions 104 ft. Current consumption per day at 1.25 ct. per kw.-hr. costs about 60 ct., which added to a labor cost of \$6.50 per day for driller and helper would make the direct operating cost about 14 or 15 ct. per ft. of hole.

Drilling with the Pneumelectric Drill. This drill was used in excavating 530 ft. of the circular shaft and 301 ft. of tunnel in Manhattan schist, on the Catskill pressure tunnel, and the following description of the efficiency of the drill and the rate of drilling has been excerpted from the Oct., 1913, number of the *Sibley Journal of Engineering* (Reprinted in *Engineering and Contracting*, Nov. 12, 1913). The compression and expansion of air is accomplished with very little thermal loss. The strokes of the piston are so rapid that expansion follows compression so quickly that the cylinder is not heated and very little loss results. Indicator cards show the compression and expansion to follow very closely the adiabatic curve with the expansion curve

very close to the curve of compression. There is compressed 9 cu. ft. of free air per minute adiabatically to $\frac{1}{8}$ volume, representing 1.63 hp. Of this probably 1.5 hp. is actually expended upon cutting the rock by action of the hammer on the dolly block and drill steel. In a $3\frac{1}{4}$ -in. piston air drill making 350 6-in. strokes per minute, with a 6-ft. drill steel, the power actually expended by the moving piston and drill steel striking the rock is 2 hp., the former consisting of 720 blows per minute of 70 ft.-lb. each.

The power consumption of the Pneumatic drill as metered for horizontal holes is 2,200 watts or 2.95 hp., and for vertical holes, 2,950 watts or 3.96 hp. The difference in power consumption is a difference in power required to rotate the steel. There is then an over-all efficiency of the motor and drill for vertical holes of 38% and for horizontal holes, 51%. The air consumption of a $3\frac{1}{4}$ -in. air drill under working conditions is 150 cu. ft. free air per minute, compressed to 85 lb. at the drill, or about 100 lb. at the receiver. To compress this air requires 30 hp. The over-all efficiency then of the compressor and air drill is less than 7%.

The actual rate of drilling per unit of power consumed is not so favorable to the Pneumatic, on account of frequent partial loss of compression, unskilled operation of the drill, and largely the use of the rose bit, which is slower cutting than the cross bit of the air machine. The average rate on vertical holes including changes of steel and shifting drills was 4.3 ft. per drill hr., or 1.1 ft. per hp.-hr. The average rate for horizontal holes was 4 ft. per drill hr. The average rate for a $3\frac{1}{4}$ -in., piston air drill in the same ground is 8.5 per drill hr. or 0.3 ft. per hp.-hr.

The troubles encountered in the drill were due to structural weakness or faulty design. Many such defects that were at first encountered were corrected during the eight months that the drills were in use. The principal sources of trouble were the loss of pressure; breaking of dolly blocks; failure to rotate; stripping gears and breaking piston rods. These troubles were greatly reduced and finally were not serious.

Speed of Auger Boring Machines. Mr. C. K. Allen (in *The Engineering Record*, Nov. 17, 1906) gives the following records of the time occupied in boring with Hardsocg coal-boring machines in hard soapstone rock with narrow bands of sandstone in a water tunnel for the Kansas City water works. Air drills and air-boring machines were tried but it was found that the time lost in connecting and setting up these heavier machines would more than offset the extra labor of drilling with the hand machines. The results of two trials timed without the knowledge

of the men are here given. Holes were drilled 6 ft. deep, three bits, 2, 4 and 6 ft. long, being used. On one trial with the machine set up with a 4-ft. bit in rock full length, the crank was placed in the end of the bit, and the steel changed to a 6-ft. bit in 2.5 min. The actual time of boring a 2-ft. hole was 4 min.; the time of changing bits and boring 2 ft. deep, 6.5 min. With the machine set up and a 2-ft. bit ready to start, boring was commenced at 3:38; at 3:44 the men changed bits and resumed boring at 3:50. There was trouble in changing the 4-ft. bits. At 4 o'clock the men changed bits and resumed boring, finishing the 6-ft. hole at 4:10. This man was rather awkward in changing his bits while he was boring this hole; the man on the other side of the heading using side gear, started and finished a hole in 16 min.

From the foregoing it would appear that the time occupied in changing each bit was from 2.5 to 6 min.; that the time occupied in boring 2 ft. was from 4 to 6 min.; thus making the total time of drilling a hole 6 ft. deep, exclusive of the time lost in taking down the machine, moving it and setting it up, from about 16 to 32 min. or at the rate of from 2.7 to 5.3 ft. per min.

The "Hole Contract System" of Reducing Drilling Costs. Rock drilling is a kind of work that is easily measured daily and therefore lends itself readily to a piece-rate or a bonus system of paying the drillers. One of the most remarkable achievements in cost reduction effected by a contract system of paying drillers is recorded in the *Transactions of the American Institute of Mining Engineers*, by Carl R. Davis, E. M., in a paper entitled "The Operation of the 'Hole Contract System' in the Center Star and War Eagle Mines, Rossland, B. C."

The mines in question contained a vein of material that was exceedingly variable in hardness and in width of deposit, so much so that it was not practicable to measure the progress of a gang of miners by the linear foot of heading or stope. An attempt was made to keep account of the progress of each gang by counting the car loads of ore sent out, but this had to be abandoned because of the impracticability of keeping separate the ore broken by each gang, since the ore broken by several gangs of men was drawn off through the same loading chute in the mine. Finally Mr. Davis, having observed that the number of feet of hole drilled (by two miners) with a power drill did not vary 5 per cent. from month to month (although it varied greatly from day to day), decided to introduce a system of paying the miners according to the number of feet of hole drilled each day. The drillers worked *in two 8-hr. shifts, two men to a shift, the four miners thus forming a contract gang.* Verbal contracts were made each month *with each gang as to price per foot drilled.* No charge was made

for repairs to tools. A blasting crew of a few picked men worked from 1 A. M. to 7 A. M. while no other miners were at work, thus avoiding delays due to smoke accumulations.

Under the old wage system each miner received \$3.50 a day, while under the "hole contract system," the earning was \$4 to \$4.25 a day. Coincident with the rise in earnings by the miners, the labor cost of drilling and blasting fell from 75 ct. a ton to 38 ct. a ton, so that the mining company effected a 50% saving in this item although the miners secured a 20% increase in wage. Likewise in shaft sinking and drifting under the "hole contract" system the miners doubled their previous outputs.

By paying a bonus of 10 ct. per ft. of hole in excess of 50 ft. per drill per shift, I had myself increased the average daily footage 50% in quarry work prior to the publication of Mr. Davis' paper; and in more recent years I have frequently doubled the daily footage by applying a bonus system.

Mr. A. R. Chambers, manager of the Wabana Iron Mines of the Nova Scotia Steel and Coal Co., wrote me, shortly after the publication of the first edition of this book, as follows:

"I am taking the liberty of sending a couple of forms showing progress in drilling at Wabana, which I trust may be of interest to you. I have been greatly interested in your book on Rock Excavation, which has been of the greatest assistance to me in arriving at the enclosed results. About January [1905] we obtained the Rock Excavation, and, after following the suggestions laid down there, we found a much better increase [in drilling footage] than previously. Good drillers are paid a bonus, and the list is posted each month."

Mr. Chambers shows that the daily footage per drill was increased 18% and that the tonnage of ore broken per day per drill was increased 70%. He attributes these results largely to the bonus system of payment and to requiring the drillers to "pay more attention to placing the holes" so as to give the dynamite the best leverage. He bulletins a monthly drill sheet, giving thereon the name of each driller, his footage of holes, tons of ore broken thereby, amount of dynamite used, and total direct cost. The ore is arbitrarily valued at about 85 ct. per ton, and the total value of the ore broken by each driller is also shown on the monthly drill sheet. The "economic efficiency" of each driller is the difference between the total value of the ore and the total direct cost of drilling and blasting it. The drillers are rated in order of merit according to this "economic efficiency."

Cost Keeping. For forms and systems of cost keeping on drilling and blasting work, the reader is referred to "Cost Keeping and Management Engineering" by Gillette and Dana.

Testing Drill Efficiency at North Star Mines, California. A method of testing drills which has proved fairly satisfactory is described in a paper by Messrs. R. H. Bedford and Wm. Hague in the *Transactions of the American Institute of Mining*

Engineers, August, 1914. The rock at the North Star Mines, California, is either close grained diabase in the upper levels or tough grained diorite on the lower levels. The veins, with an average dip of about 23 degrees, consist of about 5-ft. of formation lying between walls of country rock. Of the 5-ft., solid quartz and stringers make up 18-in. of pay ore. One-third of the holes are drilled in the quartz, two-thirds in the formation. The holes are about 4.5-ft. deep and break on the average of 1.15 tons per hole. The average number of holes per stope-drill-shift is at present 5.65. The number of drill shifts throughout the mine in 1913 was 18,679, and the cost of labor for drilling, power, supplies, upkeep of machines and air lines, and tool sharpening, amounted to 33 per cent. of the total mining expense. To do the work there were in commission forty-three No. 12-A, three No. 17-B and eight No. 16-B Waugh stopers, Three Jackhammers, two Waugh pluggers, and seventeen No. 8 and two No. 7 Water-Leyners.

Since the drilling cost may amount to one-third of the cost of delivering ore at the mill, the importance of selecting a suitable drill for the work and keeping it in a state of efficiency is obvious. Drills which seemed all right when run in the repair shop failed to work satisfactorily when underground, and there was a need of some reliable testing machine to overcome the difficulty. Mr. W. D. Paynter perfected a testing machine which he has patented. Briefly it consists of a device whereby the blow of the drill delivered against the plunger is measured by the distension of a diaphragm, oil being the medium of transmission. By means of a lever arm the movement of the diaphragm is amplified. A pencil on the end of the lever, acting on a piece of paper on a revolving drum, gives a graph of work done by the drill over a given period of time.

The general method of testing a drill consists in first obtaining a graph in the shop and then the drilling speed underground. Having passed the first test, the drill is used in the mine and a record is kept for several months of the footage drilled. Graphs taken from time to time show whether the drill is deteriorating, while the card record of repairs gives the cost of its upkeep. Drills sent to the shop for repairs are not returned to the mine until they show on the tester a satisfactory graph.

Table A compares (a) three drills striking a hard blow, (b) two drills striking a medium blow. These were tested at very hard ground with holes at an inclination of 25°, 1¼-in. cross steel with 2¼ and 2-in. bits being used. Conditions however were kept the same for each test which lasted five minutes. These results indicate that drilling speed varies approximately with the blows per minute, the strength of the blow remaining constant.

Table B compares drilling speed with varying strengths of blows. The conditions of test were: Ground only medium hard; length of each test five minutes; 1¼-in. cross steel with 2-in. bit; holes at the inclination of 45°; drill used, air feed stoper.

A test under the same conditions as in (c), except that the inclination of the holes was 20°, gave the result shown in Table C.

A test (e) was made under the following conditions: Ground hard; length of each test, 5 minutes; drill used, No. 8 water-Leyner; 1¼-in. hollow steel with 2¼-in. bit; holes nearly horizontal. In this test varying strengths of blow were obtained by means of stopes of different lengths screwed into the end of the valve check.

As already stated, Table A indicates that for blows of equal strength the drilling speed is approximately proportional to the number of blows even when these differ as much as 40%. Curves were constructed from Tables B, C and D and where the maximum variation in the number of blows was 15%, the drilling speed was arbitrarily adjusted according to the results obtained from Table D, so that the effects of the strengths of blow might be comparable. These curves all showed a tendency to flatten above a certain strength of blow, which in this ground happens to be about 45-ft. lbs. The curves for the Leyner and for the stoper at 45° inclination were almost exactly similar. This is thought to be due to the fact that in each case the face of the hole was clear of cuttings. In the cases of the flat holes which do not clear themselves the drilling speed is not only lower but does not show the same peak. This suggests that where holes can be cleared of cuttings a 45-ft.-lb. blow is sufficient to obtain the fastest drilling, whereas in holes where the deadening effects of cuttings exist the limit of effective blow is higher. This also emphasizes the desirability of a stoper with water feed to the face of the hole.

From these tests and others giving similar results it has been decided that under conditions existing at this mine, stoping drills should strike a minimum of 40-ft.-lb. As none of these drills has yet been found that strikes over 55-ft.-lb. it remains solely a question of maintenance to keep them at this point. The Leyner, with blows as high as 65-ft.-lb., presents a different problem. In this type the valve was so adjusted by means of standard plugs screwed into the ends of the valve checks as to give at average gage pressure blows in the neighborhood of 45-ft.-lb. It is hoped that this reduction of strength of blow will result in lessened breakage of steel, decreased repair costs, and maximum drilling speed. The adjustments had not been in use long enough at the time of writing the article to give any figures on the first two points.

The effect of setting the minimum strength of blow in the

stopping drills at 40-ft.-lb. has been to increase the breakage of steel by 1 lb. per drill-shift, and the cost of repairs by 27 cents per drill-shift. The footage drilled however has been increased 15%, reducing the cost per foot of hole drilled from 20.3 to 18.5 ct. The output per drill-shift has increased 10% during the same period, but this figure is complicated by the width of stope broken and is therefore not quite comparable.

Examination of Table B shows the decrease of drilling speed that may be expected with stoper striking 30-ft.-lb. as compared with 45-ft.-lb. On this point it may be stated that many confirmatory tests have been made. Unless the drills are maintained at their best the strength of blow drops rapidly (sometimes after 100 drill-shifts), with resulting decrease in drilling speed. The cost per drill-shift, however, remains practically the same.

TABLE A.

	Foot pounds.	Blows per minute.	Drilling speed feet per minute.
(a)	53	936	0.126
	52	1,320	0.165
	55	1,584	0.250
(b)	40	1,260	0.108
	42	2,352	0.195

TABLE B.

	Blows per minute.	Foot-pounds per blow.	Feet drilled per minute.
(c)	1,272	48 ½	0.378
	1,222	43	0.447
	1,200	38 ½	0.308
	1,170	34 ½	0.250
	1,090	30 ½	0.188

TABLE C.

	Blows per minute.	Foot-pounds per blow.	Feet drilled per minute.
(d)	1,272	48 ½	0.251
	1,222	43	0.206
	1,200	38 ½	0.198
	1,170	34 ½	0.135

TABLE D.

	Blows per minute.	Foot-pounds per blow.	Feet drilled per minute.
(e)	(1)	1,368	0.162
		1,272	0.234
		1,260	0.119
		1,212	0.129
	Repetition of test (1) for confirmation—		
(2)		1,368	0.135
		1,272	0.224
		1,260	0.183
		1,212	0.195

CHAPTER VI

STEAM, COMPRESSED AIR AND OTHER POWER PLANTS

Efficiency of Steam and Compressed Air Plants. I have asked several engineers and managers of air compressing plants to explain why it is that compressed air is efficient for drilling in spite of steam engine inefficiency, and invariably the answer has been to the effect that when steam is used direct in the drills there is a great loss of energy in the heat that is constantly radiated along the steam pipe line. One manager said: "It's like trying to heat the wide, wide world with your steam pipe line as the radiator." This sounds plausible, and I doubt not is believed by many to offer a full explanation of the fact that steam operated drills are not economic in the consumption of coal; but that this reason is very far from the truth we shall see presently. Indeed, if the greatest loss of fuel energy came from heat radiated by the steam pipe line, the loss could be practically stopped by the simple expedient of surrounding the pipes with a lagging of asbestos, hairfelt or the like. The great loss comes from a different source entirely, as will be made clear.

Heat Energy and Horse Power. The work required to raise 1 lb. to a height of 33,000 ft., or to raise 33,000 lbs. to a height of 1 ft. is 33,000 ft. lbs. (foot-pounds), and if this work is done in 1 min., it is 1 horse power (1 hp.). It has been found by experiment that if 778 ft. lb. of work be expended in churning up 1 lb. of water, the temperature of the water will be raised 1° F. (F. signifies that the common Fahrenheit thermometer is used in measuring the temperature). Hence 1 lb. deg.* = 778 ft. lb.

Since 1 hp. = 33,000 ft. lb., and since 778 ft. lb. = 1 lb. deg., we see that 1 hp. = 42.42 lb. deg. ($33,000 \div 778$), per min. In a word, if 42.42 lb. of water are heated 1 deg. per min., the heat energy is exactly equivalent to 1 horse power (hp.).

By reference to steam tables it is found that to make 1 lb. of steam at 70 lb. per sq. in. gage pressure requires 1,146 lb. deg.

* The expression "pound degree" abbreviated to "lb. deg." will be used instead of the common but cumbersome expression, "British thermal unit" (B. t. u.). When 2 lb. of water are heated so as to raise its temperature 30 degrees, the heat energy imparted to the water is $2 \times 30 = 60$ lb. deg., which is more in keeping with our system of indicating work in foot-pounds than to say 60 B. t. u.

of heat energy, if the water from which the steam is made is at a temperature of 60° F. to begin with. Now we have seen that 42.42 lb. deg. per min. = 1 hp.; therefore, since there are 60 min in an hour $60 \times 42.42 = 2,545.2$ lb. deg. are equivalent to 1 horse power per hour (hp. hr.). Dividing 2,542.2 lb. deg. by 1,146 lb. deg., we have 2.22 lb. of steam (at 70 lb. gage pressure from water at 60°) as the equivalent of 1 hp. That is if one horse power were exerted for an hour in churning up water, the heat developed would be equivalent to making 2.22 lb. of steam. Reversing the operation, if there were absolutely no losses of any kind, by radiation or otherwise, in the engine, 2.22 lb. of steam per hour would develop 1 hp.; but in practice there are many unavoidable losses in the best of steam engines. The exhaust steam itself carries away a tremendous amount of energy that is lost. The following table shows in a striking manner how inefficient the steam engine is at best:

Kind of Engine.	Lb. of steam per i.h.p. per hr.	Thermal efficiency of engine per cent.
Perfect (steam at 70 lb. gage from water at 60 deg.)	2.22	100.0
Superheated cross compound	8.59	21.5
Compound (good)	15 to 20.00	14.8 to 11.1
Single condensing	23.00	9.7
Large non-condensing (good)	28.00	8.0
Average size condensing	30.00	7.4
Small non-condensing	30 to 65.00	7.4 to 3.4

I.hp. is "indicated horse power" as measured with a steam indicator; b.hp. is "brake horse power" as measured with a Prony brake. The b.hp. of an engine is from 10 to 20% less than the i.hp. due to the friction losses in the engine.

The above efficiencies do not include boiler efficiency, say 75%, nor mechanical efficiency of the engine, which is about 90 to 95%. Hence a large non-condensing engine having a mechanical efficiency of 95% and a boiler efficiency of 80% gives a total efficiency of $.08 \times .95 \times .80 = 6.08\%$.

When we stop to consider what these figures mean, we wonder how an air compressor run by a steam engine can possibly compete with steam used direct in the drill; for if the heat efficiency of the engine that drives the compressor is only 11%, it means that out of every 100 lb. of steam only 11 lb. are utilized to their fullest value, and that 89 lb. virtually escape into the air without doing any useful work. But even this low efficiency does not mark the end of the losses in an air-compressing plant, for the act of compressing the air raises its temperature, and if the temperature is not kept constant during the process of compression a certain amount of useless work is done by the compressor engine.

The Work of Compression. If, by means of circulating water, it were possible to prevent the temperature of air from rising

during the process of compression, the efficiency of compression would be 100%; but if the temperature is permitted to rise the air is expanded accordingly and exerts a back pressure upon the engine. Then as the compressed air quickly loses this high temperature in the receiver and in the pipe line, it loses some of its pressure, which represents just so much wasted energy.

It is customary to rate air compressors by the number of cubic feet of "free air" that the compressor will compress to a given gage pressure per minute. By "free air" is meant the ordinary air at sea level and at a temperature of 60 deg. F. The volume of the compressed air as compared with free air is given in the fourth column of Table XVI.

The standard practice for large plants now is to compress the air in a low-pressure compressor, pass the air through an "inter-cooler," and then finish the compression to, say, 75 lb., in a high-pressure compressor. This raises the efficiency of compression to about 84%.

The free air capacity (or "displacement") of a compressor is calculated by multiplying the area of the low pressure air cylinder by the length of stroke by the number of strokes per minute.

Compressors ranging from 100 cu. ft. to 3,000 cu. ft. of free air per min. require about 14 hp. of engine capacity per 100 cu. ft. of free air per min. compressed to 80 lb. per sq. in. See Table XVI.

Table XVI gives the number of horse power required to compress air under the most favorable and under the worst possible conditions.

TABLE XVI. BRAKE (OR DELIVERED) HORSE-POWER REQUIRED TO COMPRESS ONE CUBIC FOOT OF FREE AIR PER MINUTE TO A GIVEN GAGE PRESSURE (HASWELL.)

Gage pressure lb. per sq. in.	B. h. p. required under the worst possible condition (without cooling).*	B. h. p. required under the best possible condition (with constant temperature).†	Volume in cu. ft. of air after compression at 60° F.
50	.1195	.0951	.2272
55	.1270	.0994	.2109
60	.1342	.1040	.1968
65	.1403	.1081	.1844
70	.1472	.1124	.1735
75	.1537	.1163	.1639
80	.1597	.1193	.1552
85	.1655	.1224	.1474
90	.1710	.1256	.1404
95	.1763	.1289	.1340
100	.1815	.1312	.1281

* Adiabatic.

† Isothermal.

For the purpose of comparing compressed air with steam Table XVII will be found useful;

TABLE XVII. STEAM VOLUME AND TEMPERATURE AT GIVEN PRESSURES

Gage Pressure, Lb. per sq. in.	Temperature, Fahrenheit.	Lb. Deg. from Water at 32°.	Cu. ft. occupied by 1 lb. of steam
00.0	212.0	1,146.6	26.36
50.3	297.8	1,172.8	6.53
55.3	302.7	1,174.3	6.09
60.3	307.4	1,175.7	5.71
65.3	311.8	1,177.0	5.37
70.3	316.0	1,178.3	5.07
75.3	320.0	1,179.6	4.81
80.3	323.9	1,180.7	4.57
85.3	327.6	1,181.8	4.36
90.3	331.1	1,182.9	4.16
95.3	334.5	1,184.0	3.98
100.3	337.8	1,185.0	3.82

Before we discuss the relative efficiency of air and steam it will be best to consider the amount of power required to operate a drill.

Tests of Air Consumed by Percussive Drills. There are very few reliable tests on record showing the actual air consumption of drills, yet data of some kind must be used by every engineer who has to determine the size of compressor plant needed to operate a given number of drills. The data given in catalogues will not satisfy many engineers. I have, therefore, given considerable space to such records of actual tests as I could find, and to the discussion of the tests compared with catalogue data. By all odds the most satisfactory records of actual air consumption of drills are to be found in a paper by Messrs. J. B. Carper, E. Goffe and W. C. Docharty, read before the Mechanical Engineers' Association of the Witwatersrand (April, 1904). Some very interesting data are given of the air consumption of a number of English and American percussive rock drills. The authors state that they endeavored to conduct a fair and unbiased trial of all the rock drills procurable, which represent nearly all of those on the Johannesburg market. The object of the trials was to obtain the quantity of air consumed by the different makes and sizes of drills while doing the same work.

The method of making the tests was as follows: All the holes were drilled in a block of red granite, 2 ft. thick, having the same density and hardness as that of Peterhead granite. The block was bedded in concrete, and the drills were mounted on a quarry bar supported by A frames firmly set in concrete. All holes were drilled vertically. There were two air receivers, 5 x 20 ft. each, having a combined capacity of 757 cu. ft. The air compressor was worked until the gage on the receivers showed a pressure of 80 lb. per sq. in.: then the stop valve was shut, closing connection with the receiver. Drilling was then begun *with the machine to be tested*, and continued without intermission *until the gage registered 70 lb.* The machine was then stopped, *and the depth and diameter of the hole carefully measured.* A

similar run was made from 70 to 60 lb., and so on down to 35 lb. pressure. In working out the results the capacity of the receivers was calculated for every pressure (80 down to 35 lb.). corrected for temperature, and the air consumption reduced to the equivalent of free air at 70 deg. F. and 24.8 in. barometer.

It should be noted that the air was fed into the drills hot (probably at nearly 200 deg. F.) from the air receiver.

The first set of tests was made upon each of 14 drills having 3¼-in. cylinders and using 3-in. bits. Space will not permit reprinting the tabulated results of each of these tests but I have calculated the average results of the tests on 13 of the drills, eliminating one drill which behaved in a very erratic manner, and likewise eliminating a few individual runs which showed great departure from other performances of the same make of drill. The following table gives the average results of 13 drills having 3¼-in. cylinders and using 3-in. bits:

TABLE XVIII

Rates of Drilling and Air Consumption at Different Pressures.

Air Pressure, lb.	80-70	70-60	60-50	50-40	40-35
Cu. ft. free air per min. per drill	124	117	100	70	60
Cu. ft. free air per lin. in. of hole	95.3	106.4	100.0	116.4	120.0
Cu. ft. free air per cu. in. of hole	13.3	14.8	13.8	15.0	16.6
Inches drilled per min.	1.3	1.1	1.0	0.6	0.5

In studying this table we see that the air consumption per inch drilled is somewhat erratic, but it was much more erratic in individual tests. The reason for this may be ascribed in part to the lack of uniformity in the granite, in the "personal equation" of the driller and in the efficiency of the drill itself at different air pressures. Doubtless the tempering and sharpening of the bits had a marked effect also. Each drill, it should be stated, was run by men selected by the agent of the drill, so that the "personal equation" becomes a factor of importance. However, the "personal equation" of the driller is by no means of so great importance on short continuous runs like these as upon runs several hours long. In the trials each run was about 6 min. long; that is, a run of the drill during the drop of 10 lb. in air pressure consumed on the average about 6 min.

One thing, however, is strikingly and consistently shown in the above tabulation, namely, the rapid falling off of inches penetrated per minute with every drop in the air pressure. With air pressure average 75 lb. we note that 1.3 in. per min. were drilled, as against only 0.6 in. per min. under an average pressure of 45 lb. The lesson that this teaches is that it does not ordinarily pay to overload an air compressor with more drills than it is designed to carry, and that it never pays to use a main pipe so small as to reduce the air pressure materially.

It is interesting to note that American drills were well in the lead of competitors. The best record of all the 3¼-in. machines

was made by a Rand "Slugger." Using a 3-in. bit this drill showed the following results:

TABLE XIX

Rates of Drilling and Air Consumption at Different Pressures.

Air pressure, lb.	80-70	70-60	60-50	50-40	40-35	80-35
Length of run, min.	7.166	7.583	8.550	11.666	6.416	41.381
Cu. ft. of free air per min. per drill	91.1	84.9	76.4	52.8	46.1	69.2
Cu. ft. of free air per lin. in. of hole	61.5	76.9	78.0	96.7	105.3	78.3
Cu. ft. of free air per cu. in. of hole	8.70	10.80	11.04	13.68	14.90	11.08
Inches drilled per min.	1.48	1.10	0.98	0.54	0.44	0.88

The excellence of the performance of this drill is well shown by comparing the results of its test with those above given as the average of 13 drills of the same size. Mr. Docharty attributes the poor showing made by most of the drills to poor valve design resulting in cushioned blows; and he suggests that perhaps a study of these tests will lead some of the manufacturers to improve their valve designs.

There were only four 3-in. machines tested, and, while in some instances the results were erratic, the air consumption and speed of drilling (3-in. bits) correspond very closely with the data above given for the 13 larger drills. It should be remembered, however, that no tests were made in deep holes, for under those conditions the larger machines would doubtless show their superiority. The fact that only shallow vertical holes were drilled should not be lost sight of in considering these tests.

One of the most valuable of the tests made was one with a 2¾-in. Rand "Slugger," using bits of different size. It has been claimed that the depth of hole drilled in a given time should vary inversely as the area of the hole, but there is little in the way of actual tests to substantiate this claim. While too much reliance should not be placed upon one or two tests, the following data tend to prove that in drilling granite the speed of drilling varies inversely as the square of the diameter of the bit. A 2¾-in. "Slugger" with a 6¼-in. stroke gave the following results:

TABLE XX

Rates of Drilling and Air Consumption at Different Pressures.

Air pressure, lb.	80-71	71-67	60-52	50-44	80-44
Diam. of bit, in.	2¼	2	2½	2½	2 to 2½
Length of run, min.	8.08	1.08	9.25	6.83	25.25
Inches drilled per min.	2.19	3.81	1.81	0.95	1.78
Cu. ft. free air per min.	72.5	224.2	50.2	47.3	64.0
Cu. ft. free air per lin. in.	33.0	58.8	27.7	49.7	35.8
Cu. ft. free air per cu. in.	9.88	18.72	7.83	14.03	10.45

Air pressure, lb.	80-70	70-60	60-50	50-40	40-37	80-37
Diam. of bit, in.	3¼	3¼	3	3	3	3 to 3¼
Length of run, min.	8.75	8.0	10.25	13.67	5.08	45.75
Inches drilled per min.	1.08	0.64	0.89	0.56	0.51	0.70
Cu. ft. free air per min.	69.7	72.0	56.8	43.8	33.2	55.4
Cu. ft. free air per lin. in.	64.2	112.4	81.7	77.3	64.3	78.8
Cu. ft. free air per cu. in.	8.75	15.26	11.56	10.33	9.11	11.00

It will be seen that with a bit of 2 $\frac{1}{16}$ in. in diam., the average speed was 1.78 in. of hole per min.; but with a bit of 3 $\frac{1}{16}$ in. in diam., the average speed was only 0.70 in. per min. A similar series of tests with a Climax machine of the same size gave an average of 1.1 in. of hole per min. with a 3-in. bit, as against 1.85 in. with a 2-in. bit. So far as I know these are the only published tests of drilling done under precisely the same conditions with bits of different diameters, and it is much to be desired that further tests be made on different kinds of rock to establish the ratio of speeds using different sized bits in the same drill.

In a rock that makes sludge rapidly, as for example shales, slates, and some porphyries, a drill using water under pressure for washing out the sludge will readily excel drills which depend upon the "chuck-tending" of the drill helper. As illustrating this point Table XXI shows that the Leyner-Water drill (now the Ingersoll-Leyner drill) showed up very poorly in comparison with other drills in these tests for air economy; yet this same Leyner-Water drill has made some remarkable records (page 170) in competition with other drills working in softer rocks which make sludge rapidly. Apparently the agents of the drills themselves did not in every case appreciate the difference in results that occur in drilling different kinds of rock, nor do the authors of this valuable paper mention this factor as being one of importance in comparing drill efficiencies.

TABLE XXI. TEST OF LEYNER-WATER DRILL

(Bore, 3 in.; stroke, 3 in.; weight, 156 lb.)

Air pressure, lb.	80-70	70-60	80-70	70-60	80-60
Diam. of bit, in.	2 $\frac{1}{16}$	2 $\frac{1}{8}$	2 $\frac{1}{2}$	2 $\frac{1}{4}$	2 $\frac{1}{8}$ -2 $\frac{1}{2}$
Length of run, min.	5 $\frac{1}{2}$	6 $\frac{1}{8}$	7	6 $\frac{1}{2}$	25
Inches drilled per min.	1.50	1.37	1.21	1.25	1.32
Cu. ft. free air per min. per drill	115.2	100.8	86.9	93.8	98.2
Cu. ft. free air per lin. in.	76.8	73.1	71.6	75.0	74.1
Cu. ft. free air per cu. in.	23.0	21.89	20.2	21.16	21.52

Test of Air Consumption at the Rose Deep Mine. A 6-hr. run at Rose Deep Mine, South Africa, showed the following results for 31 percussive drills: The compressed air averaged 70 lb. per sq. in. and each 3 $\frac{1}{4}$ -in. drill consumed 81 cu. ft. of free air per minute, including all leakage of pipes (there was less leakage than is common in mines). Each drill required 43 lb of coal per hour, to supply this compressed air; and each 3.4 pounds of coal developed 1 hp. per hour by the indicator on the steam engine, evaporating 6.74 lb. of water from 212 deg. F. The average horsepower of the compressor engine was 12.7 i.hp. per drill; but all the drillers were trying to make a record and accomplished in 6 hr. an amount of drilling that ordinarily took 8 hr.

It was an efficient steam power plant, as is seen by the f

was made by a Rand "Slugger." Using a 3-in. bit this drill showed the following results:

TABLE XIX

Rates of Drilling and Air Consumption at Different Pressures.						
Air pressure, lb.	60-70	70-60	60-50	50-40	40-35	30-35
Length of run, min.	7.166	7.583	8.550	11.666	6.416	41.381
Cu. ft. of free air per min. per drill	91.1	84.9	76.4	52.8	46.1	69.2
Cu. ft. of free air per lin. in. of hole	61.5	76.9	78.0	96.7	105.3	78.3
Cu. ft. of free air per cu. in. of hole	8.70	10.80	11.04	13.68	14.90	11.08
Inches drilled per min.	1.48	1.10	0.98	0.54	0.44	0.88

The excellence of the performance of this drill is well shown by comparing the results of its test with those above given as the average of 13 drills of the same size. Mr. Docharty attributes the poor showing made by most of the drills to poor valve design resulting in cushioned blows; and he suggests that perhaps a study of these tests will lead some of the manufacturers to improve their valve designs.

There were only four 3-in. machines tested, and, while in some instances the results were erratic, the air consumption and speed of drilling (3-in. bits) correspond very closely with the data above given for the 13 larger drills. It should be remembered, however, that no tests were made in deep holes, for under those conditions the larger machines would doubtless show their superiority. The fact that only shallow vertical holes were drilled should not be lost sight of in considering these tests.

One of the most valuable of the tests made was one with a 2¾-in. Rand "Slugger," using bits of different size. It has been claimed that the depth of hole drilled in a given time should vary inversely as the area of the hole, but there is little in the way of actual tests to substantiate this claim. While too much reliance should not be placed upon one or two tests, the following data tend to prove that in drilling granite the speed of drilling varies inversely as the square of the diameter of the bit. A 2¾-in. "Slugger" with a 6¼-in. stroke gave the following results:

TABLE XX

Rates of Drilling and Air Consumption at Different Pressures.						
Air pressure, lb.	80-71	71-67	60-52	50-44	40-37	30-37
Diam. of bit, in.	2¼	2	2¼	2¼	2	2 to 2¼
Length of run, min.	8.08	1.08	9.25	6.83	25.25	25.25
Inches drilled per min.	2.19	3.81	1.81	0.95	1.78	1.78
Cu. ft. free air per min.	72.5	224.2	50.2	47.3	64.0	64.0
Cu. ft. free air per lin. in.	33.0	58.8	27.7	49.7	35.8	35.8
Cu. ft. free air per cu. in.	9.88	18.72	7.83	14.03	10.45	10.45

Air pressure, lb.	80-70	70-60	60-50	50-40	40-37	30-37
Diam. of bit, in.	3¼	3¼	3	3	3	3 to 3¼
Length of run, min.	8.75	8.0	10.25	13.67	5.08	45.75
Inches drilled per min.	1.08	0.64	0.69	0.56	0.51	0.70
Cu. ft. free air per min.	69.7	72.0	56.8	43.8	33.2	55.4
Cu. ft. free air per lin. in.	64.2	112.4	81.7	77.3	64.3	78.9
Cu. ft. free air per cu. in.	8.75	15.26	11.56	10.33	9.11	11.00

It will be seen that with a bit of 2 1/16 in. in diam., the average speed was 1.78 in. of hole per min.; but with a bit of 3 1/42 in. in diam., the average speed was only 0.70 in. per min. A similar series of tests with a Climax machine of the same size gave an average of 1.1 in. of hole per min. with a 3-in. bit, as against 1.85 in. with a 2-in. bit. So far as I know these are the only published tests of drilling done under precisely the same conditions with bits of different diameters, and it is much to be desired that further tests be made on different kinds of rock to establish the ratio of speeds using different sized bits in the same drill.

In a rock that makes sludge rapidly, as for example shales, slates, and some porphyries, a drill using water under pressure for washing out the sludge will readily excel drills which depend upon the "chuck-tending" of the drill helper. As illustrating this point Table XXI shows that the Leyner-Water drill (now the Ingersoll-Leyner drill) showed up very poorly in comparison with other drills in these tests for air economy; yet this same Leyner-Water drill has made some remarkable records (page 170) in competition with other drills working in softer rocks which make sludge rapidly. Apparently the agents of the drills themselves did not in every case appreciate the difference in results that occur in drilling different kinds of rock, nor do the authors of this valuable paper mention this factor as being one of importance in comparing drill efficiencies.

TABLE XXI. TEST OF LEYNER-WATER DRILL

(Bore, 3 in.; stroke, 3 in.; weight, 156 lb.)

Air pressure, lb.	80-70	70-60	80-70	70-60	80-60
Diam. of bit, in.	2 1/8	2 1/8	2 1/8	2 1/8	2 1/8-2 1/4
Length of run, min.	5 1/2	6 1/2	7	6 1/2	25
Inches drilled per min.	1.50	1.37	1.21	1.25	1.32
Cu. ft. free air per min. per drill . . .	115.2	100.8	86.9	93.8	98.2
Cu. ft. free air per lin. in.	76.8	73.1	71.6	75.0	74.1
Cu. ft. free air per cu. in.	23.0	21.89	20.2	21.16	21.52

Test of Air Consumption at the Rose Deep Mine. A 6-hr. run at Rose Deep Mine, South Africa, showed the following results for 31 percussive drills: The compressed air averaged 70 lb. per sq. in. and each 3 1/4-in. drill consumed 81 cu. ft. of free air per minute, including all leakage of pipes (there was less leakage than is common in mines). Each drill required 43 lb. of coal per hour, to supply this compressed air; and each 3.4 pounds of coal developed 1 hp. per hour by the indicator on the steam engine, evaporating 6.74 lb. of water from 212 deg. F. The average horsepower of the compressor engine was 12.7 i.hp. per drill; but all the drillers were trying to make a record and accomplished in 6 hr. an amount of drilling that ordinarily took 8 hr.

It was an efficient steam power plant, as is seen by the fact

that 0.3 hp. were developed with each pound of coal. The power plant was a vertical King-Reidler compound steam engine and double stage air compressor with two boilers of the horizontal return tubular type. The engine developed 393 i.hp. and had a mechanical efficiency of 86%.

There were several sizes of machine-drills used, but they were all reduced to the 3¼-in. size as standard by the test of filling the cylinders, ports, etc., with water and ascertaining the volume of water for each drill cylinder. This showed the rating of the drills in air consumption to be as follows:

	Relative Air Consumption.
2½-in. drill	0.445
3¼-in.	1.000
3½-in.	1.069
3-in.	1.123

The 31 drills averaged 4.5 ft. of hole drilled per hour for the 6-hr. run; one 3¼-in. drill made 52 ft. of hole in 6 hr., drilling 4 dry holes.

Comparing the consumption of 81 cu. ft. of free air per min., at 70 lb., with the average of 120 cu. ft. (at 70 lb.) given in Table XVIII, gives a fair idea of the difference between a long test using 31 drills, and a short test of one drill.

For purpose of comparison I would add that a (1902) government report states that 2,300 air drills were in use in South Africa, 70% of which are 3¼-in. drills, and each drill requires 12 i.hp. of steam engine to run the two-stage air compressors that supply the air. The U. S. census report of mines and quarries, 1902, stated that 3,329 drills were used in the gold and silver mines of the United States. The total power required for all purposes in these mines was 195,800 hp. It is interesting to note that in 1880 only 257 power drills were used.

Air Required by Drills. As above explained, air compressors are rated according to the number of cubic feet of "free air" per minute compressed to a given gage pressure. The air in a receiver tank just after it issues from a two-stage compressor at 80 to 100-lb. pressure has a temperature of about 200 deg. F. Factory tests of air consumed by drills are usually made by drawing the heated air from the air tank, as described on page 214. But in actual practice the air is usually cool (say to 60 deg.) before it reaches the drill. A drop of 140 deg. between the compressor and the drill has a very considerable effect upon the "free air" consumption of a drill, yet I do not find mention of *this fact* in any published discussions of air consumption.

If an air compressor is rated at a given capacity of "free air" at 95 lb. pressure delivered at 200 deg., it is certainly important to rate the drills in the same terms of pressure and temperature

of compressed air; for it takes nearly 28% more work to raise a cubic foot of "free air" to 95 lb. at 60 deg. than to raise a cubic foot to 95 lb. at 200 deg.

The co-efficient of heat expansion of air is slightly less than 0.2% per deg. F. Hence, a rise of 140 deg. (at the same pressure) causes an increase of volume of nearly $0.2 \times 140 = 28\%$. Therefore, 1 cu. ft. of air at 60 deg. becomes nearly 1.28 cu. ft. at 200 deg. When no air is flowing through the air pipes, the air pressure at the receiver tank alongside the compressor is the same as the pressure at the drill; but if the air in the tank is 200 deg. while at the drill it is 60 deg., the volume of "free air" in a cubic foot of compressed air at the tank (200 deg.) is 0.78 times the volume of "free air" in a cubic foot of air at the drill.

Since the "free air" consumption of drills is ordinarily determined by tests in which the drill is operated close to the receiver tank, using compressed air at nearly 200 deg., it follows that if a drill is using compressed air at the same pressure, but at a distance from the compressor where the air has cooled to 60 deg., it will require nearly 28% more cu. ft. of "free air" than the capacity at which it has been rated by the test with air at 200 deg.

Table XXIII gives rated capacities of "free air" consumption of drills, based on tests near the compressor, and presumably with air at about 200 deg. Hence, if the air at the drill is 60 deg. and if the effective air pressure at *the drill while drilling* is 70 lb. gage, we have for a 3¼-in. drill $113 \text{ cu. ft.} \times 1.28 = 145 \text{ cu. ft.}$ (nearly) of "free air" per min.

Drills, as shown in Chap. V, however, are actually striking or cutting rock only 40 to 70% of the time, the average under most conditions being about 55%. Hence, taking 55% of 145 we have about 80 cu. ft. of "free air" consumed per min. per 3¼-in. drill throughout the entire drill shift. As a matter of fact this calculation checks closely with tests of actual drill performance in mines, such as that on page 217.

Note, however, that the *average* number of cu. ft. of "free air" per min. per drill (80 in the above example) multiplied by the number of drills does *not* give the necessary air capacity of the air compressor, for the compressor must be large enough to carry the "peak load," as explained below.

Note, also, that the friction of the air flowing through the pipes usually reduces the air pressure at the drill fully 5% below the pressure at the compressor.

Leakage of air along the pipe lines is seldom less than 5%, and, in open cut work where pipe lines are roughly laid and frequently moved, the leakage is greater.

Calculating the Needed Capacity of a Compressor. I have

shown how to calculate the quantity of air consumed per drill per shift under given conditions. It remains to indicate how to determine the proper size of the compressor.

A compressor should be large enough to carry the "peak load" without a material drop in the air pressure, for diminution in pressure reduces the cutting speed of the drills. Where only a few drills, say up to 5, are operated by one compressor, it will frequently happen that all the drills are cutting rock at the same time. In that case the compressor should have a "free air" capacity equal to the capacity of one drill multiplied by the number of drills. In the example given above it was shown that a 3¼-in. drill has a capacity of nearly 145 cu. ft. of "free air" per min. when the compressed air is 60 deg. Hence, a battery of 5 such drills calls for a compressor capacity of $5 \times 145 = 725$ cu. ft. of "free air" per min.

When, however, the number of drills drawing air from one compressor plant is greater than about 5, it will rarely happen that all the drills are cutting rock at the same time. There is a "diversity factor," but just what this factor is no tests as yet exist to show. However, we can readily establish the extremes between which it lies. If all the drills are cutting rock simultaneously the "diversity factor" is 100%, which can ordinarily occur only where there are a few drills, say 5 or less. If there is a very large number of drills, say 100, it is evident that the "diversity factor" would be the same as the percentage of time normally spent by one drill in actually cutting rock, or about 55%. In other words, with 100 drills the number is so large that only about 55 of the 100 would be cutting rock at the same time; for the changing of bits, pumping of sludge, shifting from hole to hole and miscellaneous delays will normally prevent about 45 of the 100 drills from cutting rock at the time the 55 drills are cutting.

In general, the least possible "diversity factor" is the average percentage of time spent by a single drill in cutting rock. This, as shown in Chap. V, ranges from 40 to 70%, based on careful time studies.

Until such time as adequate tests are made to establish "diversity factors," I suggest the use of the following "diversity factors":

TABLE XXII. DIVERSITY FACTORS

Number of drills 5 or less	10	20	30	40	50	50 and more
Diversity factor 100%	95%	88%	80%	70%	60%	55%

Table XXII is based on the assumption that time studies disclose that an average of 55% of a drill shift is spent in actual cutting of rock — the drill actually hammering. If more or less than 55% is thus spent, substitute the actual percentage in the

last column and grade up for the preceding columns about as in Table XXII.

Example. What should be the compressor capacity for 30 drills of 3¼-in. size, using air at 90 deg. at 70-lb. pressure at the drill?

Table XXIII gives 113 cu. ft. of free air per min. for a 3¼-in. drill at 70 lb. pressure, air being 200 deg. Since it is assumed that the air temperature drops 110 deg. (to 90 deg. at the drill), there is an air shrinkage of $110 \times 0.2 = 22\%$; hence, 113 must be multiplied by 1.22, giving 138 cu. ft. of free air capacity per drill. Table XXII gives a diversity factor of 80% for 30 drills; hence, we have $80\% \times 138 \times 30 = 3,212$ cu. ft. of "free air" per min. To this add 5% for leakage, giving a total of 3,360 cu. ft. of free air delivered by the compressor at 70 lb. plus the drop in air pressure between the compressor and the drills, say, 5 lb. Hence, a compressor of 3,360 cu. ft. "free air" per min. capacity, delivering air at 75 lb. pressure at 200 deg. is required to serve the 30 drills.

The foregoing discussion and calculation will serve to indicate how unreliable are such tables as Table XXIII, and will also indicate that Table XXII can be used properly only when a correction is made for the shrinkage of air volume due to temperature drop between the compressor and the drill.

Air Compression Above Sea Level. The following table gives the percentages of volume of compressed air delivered by a compressor at different altitudes above sea level:

Altitude feet.	Per cent.
0	100
1,000	97
2,000	94
3,000	91
4,000	89
5,000	86
6,000	84
7,000	81
8,000	78
9,000	76
10,000	74

Tables of Air Consumption in Catalogues. Table XXIII is

TABLE XXIII
CUBIC FEET OF FREE AIR PER MINUTE REQUIRED TO RUN A ONE-DRILL PLANT.

Gage Pressure.	Diameter of Drill Cylinder.															
	2"	2¼"	2½"	2¾"	3"	3¼"	3½"	3¾"	3½"	3½"	3¾"	4"	4½"	5"	5½"	
60	50	60	68	82	90	95	97	100	108	113	130	150	164			
70	56	68	77	93	102	108	110	113	124	129	147	170	181			
80	63	76	86	104	114	120	123	127	131	143	164	190	207			
90	70	84	95	115	126	133	136	141	152	159	182	210	230			
100	77	92	104	126	138	146	149	154	166	174	199	240	2			

given in the catalogue of one of the well-known drill manufacturers, and is said to be based upon actual tests of single drills running continuously without stops for changing bits, etc.

When more than one drill is to be supplied from the same air compressor the manufacturers advise multiplying the quantities given in Table XXIII by the factors given in Table XXIV to get the capacity of the compressor.

TABLE XXIV

Number of drills	1	2	5	10	15	20	30	40	70
Multiply value in Table XXIII by	1	1.8	4.1	7.1	9.5	11.7	15.8	21.4	33.2

Tables similar to Table XXIV are given by other drill manufacturers, but they are all of doubtful reliability. In answer to letters of inquiry I have been informed that such tables are "based upon experience in a large number of mines." Certainly "experience" in all mines is not the same, for the percentage of time spent by a drill in actual rock cutting varies with conditions. Table XXIV would indicate that for 70 drills the average time spent in cutting rock is $33.2 \div 70 = 47.4\%$. Chapter V indicates that this is below rather than above the general average. My discussion of this whole problem, as given in previous pages, will serve to show that Table XXIV is unreliable, giving too low capacities for compressors, particularly where the drills number less than 30.

Effect of Air Pressure on Drilling Speed. Tests show conclusively that a low air pressure is uneconomical as the force of the blow and the number of strokes per minute fall off, and the number of feet of hole drilled is very much decreased. The tendency, especially in hard rock, is to use pressures from 70 to 90 lb. or even more. It is probable, however, that a pressure as high as 80 or 90 lb. considerably increases the cost of repairs and shortens the life of the drilling machine, as well as dulls the bits rapidly. One set of tests has already been given on page 214.

Rock drills of different makers, even those having the same diameter of cylinder, vary in their consumption of air, and reliable figures are not easily obtained. In stating the consumption of air in catalogues, manufacturers do not make allowance as a rule for preventable loss of air in leaky pipes nor for other losses. The character of the rock and its hardness materially affect the consumption of air. The physical condition of the drill is important; more air is consumed by old drills because of worn valves and pistons.

Messrs. J. E. Bell and L. L. Summers (*Mining and Metallurgy*, Feb. 1, 1901) give the results of a series of experiments made of the consumption of air by a 3-in. drill per shift of 8 hr., the gage pressure being 100 lb.

Elevation.	Cu. ft. of free air	
	Per shift of 8 hr.	Per min.
Sea level	25,000 to 42,000	52 to 88
5,000 ft.	30,000 to 49,000	62 to 102
10,000 ft.	35,000 to 60,000	73 to 125

Steam Consumption in Terms of Air Consumption. When steam is piped directly from the boiler into a drill, practically the same number of cubic feet of steam are consumed as of cubic feet of compressed air.* Referring to Table XVII we find that 1 lb. of steam at 75 lb. gage pressure occupies 4.8 cu. ft., or 1 cu. ft. steam weighs 0.21 lb. Referring to Table XVI, we find that 1 cu. ft. of free air is equivalent to 0.1639 cu. ft. of compressed air at 75 lb. pressure, or 1 cu. ft. of compressed air (at 75 lb.) is practically equal to 6 cu. ft. of free air. We may assume that a cubic foot of steam will do practically the same work in a drill as a cubic foot of compressed air at the same pressure, because neither the steam nor the air acts to any great extent expansively in a drill cylinder, due to the late cut-off. This being so, 0.21 lb. of steam is equivalent to 6 cu. ft. of free air, or 1 lb. of steam is equivalent to nearly 30 cu. ft. of free air, or 1 cu. ft. of free air is equivalent to 0.035 lb. steam—all at the same pressure of 75 lb. per sq. in. If a drill consumes at the rate of 100 cu. ft. of free air per min., it will consume 6,000 cu. ft. of free air in an hour. If it were using steam in its cylinder instead of air (at 75 lb. pressure), it would, therefore, consume $6,000 \times 0.035 = 210$ lb. of steam (at 75 lb. pressure) in an hour. Referring to Table XVII, we see that 1 lb. of steam (75 lb. pressure), made from water at 32 deg., contains 1,179 lb. deg. of heat; but, as the feed water is ordinarily hotter than 32 deg., we may say that 1 lb. of steam contains 1,150 lb. deg. of heat energy imparted to it by the coal. Therefore, if a steam drill were to consume 210 lb. of steam in an hour it would use $210 \times 1,150 = 241,500$ lb. deg. of heat energy.

From Table XVI we find that to compress 1 cu. ft. of free air per min. to 75 lb. hp. pressure requires 0.1163 hp.; but we have seen that 1 hp. = 42.42 lb. deg.; hence, $0.1163 \times 42.42 = 4.933$ lb. deg. per min. are required to compress 1 cu. ft. of free air to 75 lb. gage pressure. If the air drill consumes 100 cu. ft. of free air per min., we have $100 \times 4.933 = 493.3$ lb. deg. per min., or $493.3 \times 60 = 29,598$ lb. deg. per hour. Now comparing these 29,598 lb. deg. in the hour's work of the drill using air, with the 241,500 lb. deg. in the hour's work of the same drill using steam, we see the true reason why compressed air can compete with steam in spite of all the losses of power involved in producing

* The chief engineer of the Rand Drill Co. informed me that he estimated 10 per cent. less volume of steam than of compressed air due to the fact that steam passes with less velocity through the ports.

the compressed air. The ratio of 29,598 to 241,500 is practically 1 to 8. In other words, 1 cubic foot of steam, at 75 lb. gage pressure, contains eight times as much heat energy as one cubic foot of air at the same pressure, yet so far as running the drill is concerned the air is practically as valuable as the steam. If window weights were made of gold instead of cast iron they would not be one whit more effective in counterbalancing the weight of the window, so steam is not more effective than compressed air when both act directly at pressures that are identical.

Going back again to the steam engine and the compressor it should not be forgotten that they have a combined efficiency of not much more than 10%; hence, although an air drill uses only 29,598 lb. deg. of heat energy per hour, it required $10 \times 29,598 = 295,980$ lb. deg. per hr. of energy in the form of steam that entered the compressor engines to produce the compressed air supplying the drill. Comparing this 295,980 lb. deg. of energy with the 241,500 lb. deg. consumed by the drill using steam direct we see that, if there is no loss of heat energy by radiation in the steam pipe line, it takes about 25% more coal to run each drill when compressed air is used than when steam is used in the drill. Ordinarily, however, steam pipes are left bare, and the heat radiated is nearly sufficient to equalize the coal consumption.

The Efficiency of a Steam Pipe Line. When steam is passing through a wrought-iron pipe there is a constant loss of heat, which has been found by experiment to be about 750 lb. deg. per sq. ft. of pipe surface per hour, when the surrounding air is still; and about 30% more when a wind is blowing. This is upon the assumption that the difference of temperature between the steam and the outside air is 250 deg. F. If the difference in temperature is greater the loss of heat by conduction is proportionately greater. In calculating the number of square feet of pipe surface, bear in mind that the outer surface of the pipe is meant.

TABLE XXV

LOSSES BY FRICTION AND CONDUCTION IN DELIVERING 1,000 LB. OF STEAM PER HOUR THROUGH A BARE WROUGHT IRON PIPE 100 FT. LONG, TERMINAL GAGE PRESSURE 75 LB.

Nominal Inside Diam. of Pipe in In.	Lb. of Steam Lost per Hr. per 100 Lin. Ft.		Total.
	By Friction.	By Conduction.	
1	177.7	22.0	200.6
1 ¼	58.2	29.0	87.0
1 ½	23.4	33.2	56.4
2	5.6	41.4	47.0
2 ½	1.8	50.1	51.9
3	0.7	61.1	61.8
3 ½	0.3	69.8	70.1
4	0.2	78.5	78.7

NOTE.—The loss due to friction varies as the cube of the number of pounds of steam per hour. Hence divide the delivery steam in lb. per hr. by

1,000 (1,000 being the basis of the table), cube the quotient and multiply the quantities in column two thereby. Thus if a 3-in. pipe must deliver 2,000 lb. of steam per hour, we have, $2,000 \div 1,000 = 2$, and cubing this 2 we have 8, which multiplied by the 0.7 (in column two opposite 3-in.) gives 5.6 lb. of steam lost per hr. per 100 ft. of 3-in. pipe due to friction. The loss by conduction increases but slightly as the velocity of the steam increases.

TABLE XXVI

Abstracted from a paper on "Tests of Steam Pipe Coverings," by Geo. H. Barrus, in *Trans. Am. Soc. M. E.*, 1902.

Pipe covering.	Inner Diameter of pipe, in. (nominal).	Thickness of pipe covering, in.	Weight of pipe covering per lin. yd., lb.	Cost of pipe covering per lin. ft. of pipe, not including labor, ct.	Cost per sq. ft. of pipe surface for covering in place, ct.	Lb. deg. (B. T. U.) radiated per hr. per sq. ft. of pipe surface: steam at 70 lb.; outside air at 66°.
N. Y. Air Cell (asbestos)	2	1	3.22	12.32	26	187
Gast's Air Cell (asbestos)	2	1 15/16	3.77	10.56	23	198
Carey's Moulded	2	1	5.77	8.64	20	192
Asbesto-sponge	2	1	7.25	8.64	..	194
Asbestocel	2	3/8	5.10	9.60	22	182
Magnesia	2	1	3.17	..	40	143
Asbesto-sponge (48 lams.)	2	1	6.00	19.20	37	143
Asbestos, Navy brand	2	1 1/8	3.69	18.24	35	151
Asbestos, Navy brand	10	1 3/8	12.60	66.0	25	97
Magnesia	10	1 3/16	17.88	62.7	24	88
Asbesto-sponge felt	10	1 3/8	28.55	73.3	28	70
Asbesto-sponge felt	10	1 3/8	28.55	73.3	21	75
Bare iron pipe	2	750

According to Mr. Barrus, the number of lb. deg. (or b. t. u.) of heat radiated through a pipe covering is inversely proportional to the thickness of the covering raised to the 5/8 power; according to H. G. Stott, the heat radiated is inversely proportional to the square root of the thickness of the covering. The heat losses, given in the last column of Table XXVI, are for a difference of temperature of 250 deg. F. between the steam and the outside air; for any other difference in temperature the heat loss is proportional to the ratio of the differences in temperature. The heat losses are given per square foot of the outside surface of the pipe. For the tests of pipe covering made on a 2-in. pipe, the results show a slightly higher heat loss than would occur on larger pipes, so that the tabular data are on the side of safety.

Since, according to Table XVII, 1 lb. of steam of 75 lb. pressure contains 1,179 lb. deg. of heat energy from water at 32 deg., or 1,151 lb. deg. from water at 60 deg., we have simply to divide the loss of heat expressed in lb. deg. by 1,150 to get the number of pounds of steam lost in a pipe line per hour. At 70 lb. gage pressure the loss is 750 lb. deg. per sq. ft. of bare pipe surface; hence $750 \div 1,150 = 0.66$ lb. of steam per sq. ft. per hr. Roughly

speaking, therefore, an uncovered pipe loses 0.67 lb. of steam per sq. ft. per hr. The following table gives the area in square feet of 100 ft. of pipe:

TABLE XXVII

Nominal inside diam., in.	Sq. ft. of outside sur- face of 100 lin. ft. of pipe.	Nominal inside diam., in.	Sq. ft. of outside sur- face of 100 lin. ft. of pipe.	Nominal inside diam., in.	Sq. ft. of outside sur- face of 100 lin. ft. of pipe.
$\frac{1}{8}$	22.2	$2\frac{1}{2}$	75.2	6	173.3
$\frac{1}{4}$	27.5	3	91.7	7	198.0
1	34.4	$3\frac{1}{2}$	104.7	8	225.2
$1\frac{1}{4}$	43.5	4	117.8	9	250.0
$1\frac{1}{2}$	49.8	$4\frac{1}{2}$	130.7	10	281.7
2	62.1	5	159.0

Since the heat loss in uncovered pipe is about 0.67 lb. of steam per hr. per sq. ft. of pipe surface, we have merely to multiply the number opposite the pipe of given size in Table XXVII by 0.67 to determine the approximate loss of steam. In a $\frac{3}{4}$ -in. pipe the area is 27.5 sq. ft. per 100 lin. ft. of pipe; hence, the steam loss is $0.67 \times 27.5 = 18.4$ lb. of steam per hr. If the pipe is 150 ft. long the loss is $27\frac{1}{2}$ lb. of steam per hr. due to radiation, at least 80% of which loss can be saved by using a pipe covering little more than an inch thick. Pipe coverings can be bought in short lengths that slip like sleeves over the pipe. For outdoor use the covering should be of some flexible variety, preferably of asbestos fibre (not molded hard with plaster), wrapped with waterproofed canvas. A fair idea of the prices may be had by inspecting Table XXVI.

In a compressed air pipe line there is no loss of energy by heat radiation; hence the larger the pipe the greater its efficiency in conveying the air without reducing its final pressure at the drill. But in a steam pipe line the larger the pipe the greater the loss by heat conduction, whereas the smaller the pipe the greater the loss by friction. Hence for any given quantity of steam to be delivered per hour there is just one size of pipe that will give a minimum loss of energy, which may be calculated from the data given in this chapter.

Steam pipe 1,000 ft. long and covered with "a jacket of air cell covering enclosed in canvas and an outside layer of tar paper" was used to supply twenty derricks with steam from a 250-hp. boiler on the Riverside Drive Extension work. The *Ryan-Parker Construction Company* were the contractors. Mr. A. McC. Parker wrote me on March 31, 1905, that the pipe cov-

ering was "air cell covering," consisting of a paper cell covering covered with white duck. It was protected from wet by tar paper. The pipe ran from 4 in. to 2.5 in. in diameter and extended 800 ft. from the boiler. "As many as 20 engines were going at once and good steam was had at all times. There was no question as to the economy compared to using the steam in an air compressor and distributing the air that distance (800 ft.)." The contractors had no serious trouble due to condensation in the line. This was overcome by drips at intervals.

The cost of lagging steam pipe with standard magnesia pipe covering is given by Mr. R. K. Stockwell in *Engineering and Mining Journal*, Mar. 22, 1913. The work comprised the covering of 2,400 ft. of high pressure steam heating line running from the power house to the concentrator, and the steam and feed water lines of two 450-boiler-hp. reverberatory-furnace waste-heat boilers, at McGill, Nevada, in October, 1909. The men who did the work were pipe fitters rated at 50 ct. per hr., each with two helpers at 37.5 ct. per hr. The high pressure covering was 1.5 in. thick, held away from the pipe by bands of magnesia 1 in. thick, 18 in. apart. The covering for 10-in. and larger pipe came in keystone-shaped strips, and was placed on the bands, the cracks plastered with magnesia mud and cement, the whole covered with canvas, clamped with brass bands 30 in. apart, and painted with tar and gasoline. The high pressure pipe covering for pipes 8 in. and less in diam. came in half cylinders 1.5 in. thick, and the low pressure pipe covering for pipes of less than 8-in. diam. in half cylinders 1 in. thick. The finish was the same as for the large high pressure pipes. The magnesia coverings for fittings, valves, etc., had to be sawed and fitted to the work by hand, which was slow and expensive. In the labor costs which follow all flanges are figured as part of flange unions.

Labor costs of applying magnesia covering to pipes and fittings:

High pressure covering.	Cost per lin. ft.
4-in. pipe	\$.17
8-in. pipe38
10-in. pipe79
12-in. pipe	1.25
8-in. pipe bends	1.03
	Cost each.
1.5-in. elbows	\$1.30
8-in. elbows	3.30
10-in. elbows	3.58
12-in. elbows	4.90
4-in. expansion joints	2.60
10-in. expansion joints	5.63
12-in. expansion joints	6.15
1.5-in. flange unions	1.03
4-in. flange unions	1.19
8-in. flange unions	3.19
10-in. flange unions	3.40
12-in. flange unions	5.49
1.5-in. valve bodies	1.80

High pressure covering.		Cost each.
8-in. valve bodies	3.28
10-in. valve bodies	3.60
12-in. valve bodies	4.90
8-in. valve bonnets	3.25
10-in. valve bonnets	3.60
12-in. valve bonnets	3.70
Low pressure covering.		Cost per lin. ft.
2.5-in. pipe	\$.10
4-in. pipe12
		Cost each.
2.5-in. flange unions	\$1.15
2.5-in. tees	1.30
4-in. tees	1.75
2.5-in. elbows	1.30
2.5-in. valve bonnets	1.98

Pipe Lines for Transmitting Compressed Air. These are usually of wrought iron, although cast iron is sometimes used. Pipes up to 3 in. in size are usually butt-welded, and larger tubes are lap-welded because of the greater strength that lap-welding gives. All piping and fittings for air lines should be galvanized, as the scale from black pipe may injure air tools. Wrought iron spiral seamed riveted pipe is sometimes used, particularly in the very large sizes with low pressures. For transportation to mountainous regions, rolled sheets, punched at the edges ready for riveting, can be obtained. The sizes and weight of standard pipe are given in Table XXVIII.

Wrought iron pipe lengths are connected by sleeve couplings or cast iron flanges, into which the ends of the pipe are expanded or threaded, sleeve couplings being used for all except the largest sizes. Gaskets should be used in flanged joints, and near the receiver these gaskets should be of asbestos, but elsewhere brown paper is satisfactory. Expansion joints are necessary on long lines.

Pipe line leakage should be carefully watched and prevented. At No. 6 Colliery, Glen Lyon, Pa., the main pipe line was 4,380 ft. long and 5 in. in diameter with a capacity of 608 cu. ft. The branch line was 3,100 ft. long 3 in. in diameter with a capacity of 159 cu. ft. The gage pressure was 60 lb. which gives an equivalent capacity of 32,500 cu. ft. of free air. The loss per hour from leaks was 974 cu. ft. of free air, 4.18% of the total air compressed.

While there is a large loss of power due to the cooling of the air that has been heated during compression, which takes place very quickly in the receiver and in the nearest piping, it is far cheaper to reheat the air before using it expansively in drills and other machines, than to try to retain the heat in the pipe by lagging, when the air has to be conveyed more than a few hundred feet.

TABLE XXVIII. AIR LINE PIPE (NATIONAL TUBE CO.)

All Weights and Dimensions are Nominal.

Size	Diameters,		Weight per				Couplings		Length,	Weight
	Ex-ternal	In-ternal	Thick-ness, in.	Plain ends	Threads and couplings	Threads per inch	Diam-eter, in.	in.		
1½	1.900	1.582	.159	2.956	3.00	11½	2.387	2½ ₁₆	1.364	
2	2.375	2.043	.166	3.916	4.00	11½	2.976	3½	2.416	
2½	2.875	2.423	.226	6.393	6.50	8	3.544	4	3.772	
3	3.500	2.990	.255	8.837	9.00	8	4.272	4½	5.899	
4	4.500	3.996	.252	11.433	11.75	8	5.500	4½	9.124	
5	5.563	4.977	.293	16.491	17.00	8	6.652	6	16.720	
6	6.625	6.025	.300	20.265	21.00	8	7.833	6	21.826	

The permissible variation in weight is 5% above and 5% below.
Furnished with threads and couplings and in random lengths unless otherwise ordered.

The above pipe is fitted with special air line couplings recessed for lead calking.

Taper of threads is ¾ in. diameter per ft. length for all sizes.

The weight per foot of pipe with threads and couplings is based on a length of 20 ft. including the coupling, but shipping lengths of small sizes will usually average less than 20 feet.

Flexible Metal Hose. For conveying steam from the pipes to the drills, "Flexible Metallic Tubing" is preferable to ordinary hose. With this all-metal hose, the oiler is placed at the end of the steam pipe, to lubricate the hose as well as the machine. When several drills are run from the same boiler, a sight-feed lubricator is placed on the main steam pipe, thus saving the drill runner the bother of oiling, and insuring a regular and continuous lubrication of the hose and machines. This hose is made of steel or copper. Mr. McFarlane states that it is greatly superior to any make of rubber steam hose. The life of this metallic tubing, he says, is 6 months as compared to 2 months for the best grades of rubber hose. He used one piece of hose for 9 mos. continuously. He paid \$19 for a 25 ft. length of 1-in. hose with spuds and couplings and \$23.75 for the same length of 1¼-in. hose.

With this hose high steam pressure can be used for deep hole drilling and also for work during freezing weather. At a temperature of 45 deg. below zero, drills were run at a distance of from 500 to 600 ft. from the boiler.

Reheating Compressed Air. To obtain the highest efficiency from compressed air, it is necessary to reheat it just previous to expanding it in drills, channels, hoists, etc. Usually this is done by one of two methods: (1) The air is passed through a cast iron chamber or coil of pipe, exposed to a fire or current of hot gases or steam; (2) the heat is added within the body of the air itself by the combustion of fuel, the injection of steam or hot water or the placing in the air pipe of an electric-resistance coil. The first method is generally used.

The results theoretically obtained are as follows: Assuming

the weight of 1 cu. ft. of steam at 75 lb. gage pressure = 0.21 lb. and the total units of heat in 1 lb. of steam at 75 lb. pressure produced from water at 60 deg. F. temperature = 1,151, then the total units of heat (lb. deg. or b.t.u.) in 1 cu. ft. of steam at 75 lb. pressure = 1,151 multiplied by 0.21 = 241. To produce by compression through a steam-actuated air-compressor 1 cu. ft. of compressed air at 75 lb. pressure and 60 deg. F. temperature, about 2 cu. ft. of steam at the same pressure are required (assuming a 50% compressor efficiency), or the heat-units employed in producing 1 cu. ft. of compressed air will be about 241 multiplied by 2 = 482 heat units, as the thermal cost of 1 cu. ft. of compressed air at the above temperature and pressure. The temperature and volume of the air as it leaves the compressor will be considerably higher than the figures here assumed, but as the air is invariably stored for a time, or is transmitted through pipes to a distance between its compression and ultimate employment, it returns to its normal temperature before it is used, so that, whatever we may have at the compressor, the air as it is delivered at the motor will have cost, as above stated, 242 heat units for 1 cu. ft. at 75 lb. pressure. The difference in the thermal cost of any volume of compressed air thus produced by mechanical compression and the cost of any additional volume of air that may result from the subsequent reheating of the air, is very striking.

Assuming the weight of 1 cu. ft. of free air at 60 deg. F. temperature as 0.076 lb. and the weight of 1 cu. ft. of compressed air at 75 lb. pressure and 60 deg. F. temperature as 0.456, then the units of heat required to double the volume of 1 lb. of air at 60 deg. F. will be 124, and the units of heat required to double the volume of 1 cu. ft. of compressed air at the same pressure and temperature, will be 124 multiplied by 0.456 = 56.5.

Therefore the cost of 1 cu. ft. of superheated air at 75 lb. pressure compared with the cost of 1 cu. ft. of compressed air as produced by ordinary compression is as follows:

$$56.5 : 482 : : 0.12 : 1$$

Here we see that the cost in heat-units of the volume of air produced by the reheating is less than one-eighth of the cost of the same volume produced by compression.

Types and Sizes of Reheaters. Reheaters, as a rule, consist of a vertical cylinder fitted with tubes, coils, or deflecting plates for carrying the compressed air through and among the gases and heated air from a fire below. They are customarily made in sizes weighing from 275 to 3,000 lb. and with capacities ranging from 100 to 800 cu. ft. of free air per minute.

As air passes through the reheater its temperature may be increased to about 250 deg. F. which causes it to expand 30% to

35%, and results in a saving of 15% to 20% in power at the machine.

The effect of reheating compressed air is shown by the following examples: With a plain slide valve hoist, to develop 1 hp. will require the compression of about 24 cu. ft. of cold free air, but only 16.5 cu. ft. of air warmed to 300 deg. F. A first motion Corliss hoist with compound cylinders requires 24 cu. ft. of cold free air and only 7.5 cu. ft. of air warmed to 400 deg. F. to develop 1 hp. An ordinary direct-acting pump required 100 cu. ft. of free cold air, or 75 cu. ft. of air warmed to 300 deg. F. to do the same work. In a compound direct acting pump 60 cu. ft. of free air was required when the air was heated sufficiently to prevent freezing, and 50 cu. ft. when the air was heated to 300 deg. F. before it entered the high pressure cylinder and 40 cu. ft. if heated before it entered the low pressure cylinder as well, to do the same amount of work.

Flow of Air Through Pipes. Tables XXIX to XXX are based upon D'Arcy's formula. Table XXIX gives the number of cubic feet of free air delivered per minute through a pipe 100 ft. long without any loss of pressure. Table XXX gives the factors, F, to be used for different lengths of pipe. Table XXXI gives the multipliers, M, to be used to determine the loss of pressure. The following formulas are to be used with these tables:

$$(1) Q = L \times F \times M$$

$$(2) M = \frac{Q}{L \times F}$$

$$(3) L = \frac{Q}{F \times M}$$

$$(4) F = \frac{Q}{L \times M}$$

Q = cu. ft. of free air discharged per min.

L = factor given in Table XXIX.

F = factor given in Table XXX.

M = factor given in Table XXXI.

Example 1. Given a 4-in. pipe, 600 ft. long, initial air pressure 60 lb., required to discharge 1,200 cu. ft. of free air per min., what will be the terminal pressure?

By Table XXIX, under 4-in. pipe and opposite 60 lb., we find L = 1.535.

By Table XXX, for 600 ft., F = 0.408.

$$\text{Hence, } M = \frac{Q}{L \times F} = \frac{1,200}{1,535 \times 0.408} = 1.9 \text{ lb.}$$

Now by Table XXXI, opposite 60 lb. pressure and under 4 lb. reduction, we find M = 1.89, so that the loss of pressure being 4 lb. we have a terminal pressure of 56 lb.

Example 2. Given a 6-in. pipe, 2,000 ft. long, initial pressure 80 lb., terminal pressure 70 lb., what will be the volume discharged?

By Table XXIX, under 6-in. pipe and opposite 80 lb., we find $L = 4,971$.

By Table XXX, for 2,000 ft. length, $F = 0.224$.

By Table XXXI, under 10 lbs. reduction and for 80 lb. pressure, we find $M = 2.82$.

$$Q = L \times F \times M = 4,971 \times 0.224 \times 2.82 = 3,140 \text{ cu. ft. per min.}$$

TABLE XXIX. GIVING FACTOR L

Gage, lbs.	Nominal Diameter of Pipes in Inches.											
	1"	1½"	2"	2½"	3"	3½"	4"	5"	6"	7"	8"	10"
50	38.96	122.4	243.4	396.3	701.5	1030	1430	2558	4114	5993	8312	14910
60	41.83	131.4	261.1	425.4	752.9	1105	1535	2747	4416	6433	8920	16000
70	44.53	139.9	278.0	452.9	801.8	1170	1634	2925	4701	6848	9499	17030
80	47.08	147.9	294.0	478.8	847.6	1244	1728	3091	4971	7240	10040	18000
90	49.54	155.6	309.3	503.8	891.8	1307	1817	3253	5230	7619	10560	18940
100	51.88	163.0	324.0	527.5	933.8	1370	1904	3407	5477	7979	11050	19850
110	54.10	169.9	337.8	550.1	973.9	1429	1985	3552	5712	8320	11530	20690
125	57.15	179.5	356.8	581.3	1028	1510	2097	3754	6034	8789	12180	21860
150	62.10	195.1	387.8	631.7	1117	1641	2280	4080	6558	9553	13240	23760

TABLE XXX. GIVING FACTOR F

Length, feet.	Multiplier F.	Length, feet.	Multiplier F.
100	1.0	6,000	0.129
200	0.707	7,000	0.119
300	0.577	8,000	0.112
400	0.500	9,000	0.105
500	0.447	10,000	0.100
600	0.408	12,000	0.0912
750	0.365	15,000	0.0817
1,000	0.316
1,250	0.283
1,500	0.258
2,000	0.224
2,500	0.200
3,000	0.183
3,500	0.169
4,000	0.158
5,000	0.141

TABLE XXXI. GIVING FACTOR M

Initial Gage Pressure. Pounds	Reduction of the final pressure in pounds per square inch.															
	1	2	3	4	6	8	10	12	14	16	18	20
50	0.984	1.37	1.65	1.87	2.22	2.48	2.67
60	0.986	1.37	1.66	1.89	2.24	2.52	2.74
70	0.988	1.38	1.67	1.90	2.27	2.56	2.79	2.97	3.12	3.24
80	0.989	1.38	1.67	1.91	2.29	2.59	2.82	3.02	3.19	3.32	3.43	3.53
90	0.990	1.38	1.68	1.92	2.31	2.61	2.86	3.06	3.24	3.39	3.51	3.61
100	0.991	1.39	1.68	1.93	2.32	2.63	2.88	3.10	3.28	3.44	3.57	3.69
110	0.992	1.39	1.69	1.93	2.33	2.64	2.90	3.13	3.32	3.48	3.63	3.75
125	0.993	1.39	1.69	1.94	2.34	2.66	2.93	3.16	3.36	3.54	3.69	3.83
150	0.994	1.39	1.70	1.95	2.36	2.69	2.97	3.21	3.42	3.61	3.77	3.92

Steam Boiler Efficiency. Steam boilers are commonly rated as having so and so many horse-power capacity. This is a very misleading and unsatisfactory way of rating a boiler, for the horse power of work that a boiler can do depends entirely upon the kind of engine to which the steam goes. A boiler that supplies 1,600 lb. of steam per hour to compound condensing engine using 16 lb.

of steam per hp., evidently develops 100 hp.; yet if this very same boiler is made to feed an ordinary single cylinder non-condensing engine using 40 lb. of steam per hour, it will develop $1600 \div 40 = 40$ hp. In buying a boiler, therefore, be sure to secure the manufacturer's guarantee, not of its horse power, but of its steam capacity in pounds of steam per hour at a given gage pressure (say, 70 lb. per sq. in.), using a fuel of a kind stated in the guarantee. The American Society of Mechanical Engineers has recommended that wherever the word horse power is used in reference to boilers, it shall mean 30 lb. of water evaporated from 100 deg. F. to steam having a gage pressure* of 70 lb. per sq. in. under average firing without forcing the boiler, and by forcing the same boiler should be capable of evaporating one-third more steam per hour than its ordinary rating; that is, a 100 hp. boiler (30 lb. steam per hr. per hp.) should be capable of developing 133 hp. if forced. Unfortunately manufacturers usually pay no attention to this suggested rating, and perhaps they can hardly be blamed, because if it were always followed we should see at times a 100 hp. boiler used to run a 200 hp. compound condensing engine, while at other times the same 100 hp. boiler would be used to run a 100 hp. non-condensing single engine.

By careful tests it is easy to ascertain how many lb. deg. can be developed by 1 lb. of any fuel burning under perfect conditions. Thus 1 lb. of perfectly pure carbon will develop 15,000 lb. deg.; that is, it will raise the temperature of 15,000 lb. of water 1 deg.; or 150 lb. of water 100 deg. Coal is never entirely pure carbon, but contains some ash and other materials. All mechanical engineers' handbooks contain tables of the heating value of different kinds of fuel, with which it is well to be familiar whenever there is a choice of fuels.

When coal is burned under a boiler a large percentage of its heat passes up the chimney in the gases and is lost; and in addition to this loss the boiler itself radiates heat constantly. The greater part of the loss occurs in the heat that goes up the chimney. In large, well designed boilers, properly protected by asbestos or similar covering, the coal burned will develop steam to about 85% of the full heat value of the fuel; the efficiency of the boiler and furnace is then 85%. In locomotive boilers where forced draft is used, firing not of the best and boiler exposed to moving air, the efficiency is often as low as 45%. The efficiency of a good boiler of moderate size (100 hp.), well housed, is ordinarily about 75%. A small (20 hp.) boiler exposed to the wind has an efficiency of 55 to 60% when not forced.

* The atmosphere has a pressure of 14.7 lb. per sq. in., and since a steam gage shows the steam pressure above atmospheric pressure, we must add 14.7 to the gage pressure to get the "absolute pressure."

If a small boiler is used to run one drill, the boiler must always have up enough steam to keep the drill running at nearly full capacity; but when the drill is stopped, during the changing of bits, moving, etc., there is a waste of steam, because the period of stoppage is not long enough to permit the fireman to make any material change in the firing and in the draft. Hence one single drill (3¼ in.) must be counted upon as using about 250 lb. of steam per hour (see page 223). A 1-in. steam pipe 200 ft. long, if not covered, will lose nearly 50 lb. of steam per hour by condensation (and often as much more by leakage), thus making a total steam consumption of $250 + 50 = 300$ lb. per hour, due to the drill and the pipe line. If 1 lb. of coal will develop 14,000 lb. deg., and if the small exposed boiler has an efficiency of 58%, we have $14,000 \times 58\% = 8,120$ lb. deg., which divided by 1,150 (the lb. deg. required to produce 1 lb. of steam at ordinary pressures) gives about 7 lb. of steam produced by 1 lb. of coal. Therefore, $300 \div 7 = 43$ lb. of coal required per hour to supply steam for the drill and pipe line. We have still to add the loss of fuel when the fire is drawn at night, as well as the loss of radiated heat during the starting of the fire in the morning, and leakage losses. Not less than 150 lb. of coal per day are thus consumed in a small boiler, bringing the total coal consumption up to 580 lb. of coal for running the one 3¼-in. drill one 10-hr. shift.

Boiler Capacity for Steam Drills. In open cuts where the number of drills served from one power plant is small, it is customary to run them by steam instead of compressed air. A 125 hp. boiler will supply enough steam to run 7 drills (3½ × 6 in.), the boiler gage pressure being 140 lb., and the main steam pipe about 400 ft. long and not lagged. Adding one more drill to such a plant reduces the efficiency of all the drills. Hence it is not wise to use less than 18 hp. per 3½-in. drill and 16 hp. per 3¼-in. drill, when operating drills with steam. A boiler plant for 7 drills will use about 720 lb. of coal per 3½-in. drill, and 650 lb. per 3¼-in. drill per 10-hr. shift. These figures are not based on theory but on actual experience.

Merits of Compressed Air. A compressed air plant was installed at a large stone quarry where drills and channelers had formerly been run by steam direct from a large number of small boilers. When the compressed air plant was installed the coal consumption was reduced from 50 tons per day to 15 tons per day. Due to the higher and more even pressure of the air (as compared with the steam from the small boilers), fewer drills and channelers were needed, because each did more work than before. Moreover, there were no delays in the morning, getting up steam, as is usually the case where a large number of small

boilers are operated. This excellent and remarkable result could probably have been accomplished at less expense by installing a central steam boiler plant and using lagged steam pipes. The steam pipes would have required expansion joints and traps for draining off water of condensation similar to those in the air pipe system. This plant was advertised as proving conclusively the advantage of using compressed air instead of steam in drills. What it mainly proves is that a central power plant is far more economic than a large number of small plants. We have seen that the efficiency of small boilers is often 45% or lower, as compared with the 85% efficiency of large boilers. We have also seen that a small boiler supplying one or two drills must always carry enough steam to keep both drills going at their full steam consumption, in spite of the fact that the drills are not working more than 40 to 70% of the time; whereas with a large central plant the drills "average up," some running while others are not, thus greatly reducing the average daily coal consumption. Compressed air has many advantages over steam for operating drills, but a reduction in the coal bill is not one of them (in spite of belief to the contrary) if a fair comparison is made between a central steam plant with covered pipes and a central compressor plant.

Compressed air, however, possesses several advantages distinctly its own, which may be enumerated as follows: (1) It does not rot the hose from the pipe to the drill, and a much cheaper hose may be used and consequently a longer hose than with steam. (2) Less oil is required to keep the drill lubricated. (3) In warm weather the exhaust air makes working around the drill comfortable. (4) A trench or quarry pit is not filled with steam, making it difficult at times to see. (5) There is no danger of injuring the drill itself by sudden expansion due to heat. (6) There are no pipes to thaw out in winter due to condensed water carelessly allowed to collect. (7) Plug drills can be used for block holing, plug and feathering, etc. (8) The air can be used for blowing the sludge and water out of a hole before charging. (9) The air can be used for forcing a jet of water into a hole alongside of the drill-rod. (10) The machine being cool is easily handled. (11) Water power may be used for compressing the air.

Various Types of Compressors. Single or two-stage compressors are efficient when the pressure desired ranges from 80 to 100 lb. When the pressure is 100 lb. a two-stage machine will save approximately 13% power; at 80-lb. pressure it saves just enough power to justify its use under average conditions. A single-stage machine is sufficient for compressing air to pressures of less than 80 lb.; a two-stage machine is required for pressures

ranging from 100 to 500 in.; a three-stage machine for pressures of 500 to 1000 lb.; and a four-stage machine for pressures of over 1000 lb. When the pressure desired is below 25 lb. the machine does not require a water jacket. Simple steam driven machines are generally furnished in capacities up to 1,400 cu. ft. of free air per min. Duplex compressors are commonly used for higher capacities. When the motor power is furnished by an electric motor, gas motor, or belt drive, for capacities above 200 cu. ft. the duplex machine is suited.

Efficiency Test on the Jerome Reservoir Compressor Plant.

There are few records of careful tests of the efficiency of boilers, engines and air compressors of a single plant. In Saunders's "Compressed Air Information," p. 193, a very complete record is given of a 10-hr. test of a plant in operation, supplying air to 14 drills, 14 derrick engines and three small pumps. The test was made by George W. Vreeland and Charles M. Younglove.

The plant was used in excavating the site of the Jerome Park Reservoir, N. Y. (under construction in 1904), and consists of one Ingersoll-Sergeant Corliss cross-compound condensing air compressor plant, receiving steam from two Hogan boilers, each of 270 hp. (nominal). The following are some of the data of the test:

Steam gage, lb. per sq. in.	116.5
Coal used per hour, lb.	928
Dry steam per hour, lb.	8,274
Efficiency of boiler	78.1%
Steam per i. hp., lb.	17.36
Total b. hp. of engines	402
Mechanical efficiency of engines	86%
Thermal efficiency of compression	82%
Free air per min., cu. ft.	2,800
Free air per min., cu. ft.	6
Gage pressure of compressed air, lb.	67.5
Heat supplied to engine per hr., lb. deg. (B. t. u.)	9,634,246
Heat utilized by engine per hr., lb. deg.	1,177,437

This is a fairly large compressor plant, capable of carrying at least 35 drills ($3\frac{1}{4}$ -in.); and if it were loaded with 35 drills, each drill would be charged with 265 lb. of coal, for a 10-hr. run, or 276 lb. of steam per hour, or with 13.4 i.hp. of compressor engine.

Particular note should be taken of the heat efficiency of the engine, which may be calculated by dividing the 1,177,437 lb. deg. by the 9,634,246 lb. deg., the quotient being 12.3%. Those who have not made a careful study of the compressed air problem would be misled by the statement that the efficiency of compression is 82%, and would be apt to think that this was for the engine and compressor plant. In fact the true heat efficiency of this plant was $12.3 \times .82 = 10.086\%$, a trifle more than 10% — which checks closely with the calculations in the fore part of this chapter.

Cost of Compressor Plants and Coal Consumption on 4 Jobs.
 In "Rock Drilling" by Dana and Saunders the following data are given for five excavation jobs:

No. 1. On D. L. & W. Ry. work in New Jersey, D. M. Flickwir, contractor, operated 17 Ingersoll-Rand drills ($3\frac{1}{4} \times 6$ in.) with two air compressors, one Ingersoll of 1,700 cu. ft. air per min. capacity and one Kiernon of 550 cu. ft. capacity. The air was 100 lb. per sq. in. at the compressor. The 17 drills and compressor plant, boilers, etc., cost \$14,300, which is about \$830 per drill. The compressor capacity was 130 cu. ft. of air per min. per drill. There were 8 tons of coal (940 lb. per drill shift) and 4 gal. oil used per day. (10 hr.) by the compressor; and 2 pt. of oil per day was used to oil each drill. The main 6-in. air pipe was $1\frac{1}{2}$ miles long. Work was in a tunnel and an open cut.

No. 2. On D. L. & W. Ry. work in New Jersey, Reiter, Curtis & Hill, contractors, operated 16 Ingersoll-Sergeant drills ($3\frac{1}{2} \times 6$ in.) with two air compressors of 250 hp. each (steam cylinder 24×30 , air cylinder $24\frac{1}{4} \times 30$), air pressure 100 lb. The 16 drills and compressor plant, boiler and air-pipe cost \$18,075, or \$1130 per drill. This is a high cost, and the 500 hp. engine capacity, or more than 30 hp. per drill, indicates that the compressor plant could have supplied twice as many drills. Coal used was 7 short tons per 10 hr. day, or 875 lb. per drill shift. The compressor used 4 gal. oil, and each drill used 3 pt. oil per day.

No. 3. In the crushed limestone quarry of the Brownell Impr. Co., Thornton, Ill., 14 drills (2 used infrequently) were operated by a single stage compressor of 1,200 cu. ft. per min. air capacity. Air pressure was 120 lb. at the tank. The drills, compressor plant and boilers cost \$7,700, or about \$640 per active drill (12 drills).

No. 4. In driving a tunnel on the Catskill aqueduct, Blakeslee & Sons, contractors, used 8 Ingersoll-Rand drills ($3\frac{1}{4} \times 6\frac{1}{2}$ in.) at one face, operated by 2 Ingersoll-Rand (type 10) compressors. The 8 drills, compressors and boilers cost \$7,300, or \$910 per active drill.

Prices of Air Compressors. Compressor prices may be estimated in dollars per cu. ft. free air capacity per min., thus:

Steam Driven, Tandem, Two Stage Horizontal Compressors.
 The prices of these compressors range from \$2.90 per cu. ft. of free air capacity for the $14 \times 16 \times 10 \times 14$ -in. having a capacity of 690 cu. ft., to \$2.00 for the $24 \times 27 \times 16 \times 27$ -in. machines having capacities of 2,180 cu. ft. of free air per min.

Power Driven, Duplex, Cross-Compound, Horizontal Compressors. The price per cu. ft. of displaced air ranges from \$4.30 for the $10 \times 6 \times 10$ -in. size having a capacity of 205 cu. ft., to \$2.00

for the 25 x 15 x 20-in. size having a capacity of 1,700 cu. ft. of air displaced per min.

Steam Driven, Duplex, Two Stage, Horizontal Compressors. The prices of compressors of this type with simple steam cylinders vary from \$5.50 per cu. ft. of displaced air for the 7 x 10 x 6 x 10-in. size having a capacity of 205 cu. ft., to \$3.00 for the 18 x 18 x 17 x 24-in. machines with capacities of 2,380 cu. ft. per min. These compressors are usually sold with cross-compound steam cylinders which cost extra about 35 ct. per cu. ft. of air capacity.

Corliss Engine Driven Compressors, Simple Steam, Two Stage Air Cylinders. The prices of these machines with simple steam cylinders range from \$3.75 per cu. ft. of air displaced for the 16 x 27 x 16 x 24-in. compressors, having capacities of 2,000 cu. ft. to \$2.90 for the 22 x 37 x 22 x 36-in. compressor, having capacities of 4,200 cu. ft. per min. They are usually sold with cross compound steam cylinders which cost extra about 35 cts. per cu. ft. of air.

The following prices of air compressors have been excerpted from "Handbook of Construction Plant" by Richard T. Dana.

Westinghouse Locomotive Compressors. These small machines are capable of operating one or two hand-hammer machine drills. They may be fastened to the boiler of a locomotive or steam-shovel and used to furnish air to drills for block-holing or other light work. The prices of these compressors are as follows:

Size	8 in.	9½ in.	11 in.	Cross Compound 10½ in.
Displacement, cu. ft. of air per min.	20	28	45	50
Weight, net lbs.	450	525	850	1,800
Price	\$90	\$100	\$150	\$325

The price of the necessary equipment such as lubricator, governor, gage, reservoir, etc., will amount to about \$50 additional.

Power Driven, Straight Line, Single Stage, Horizontal Air Compressors. The price of compressors of this type range from \$4.75 per cu. ft. of air per min. in the 6 x 6-in. cylinder machines, having a capacity of 40 cu. ft., to \$2.25 per cu. ft. in the 14 x 10-in. size having a capacity of 335 cu. ft. per min.

Steam Driven, Straight Line, Single Stage, Horizontal Air Compressors. The price of these machines range from \$8.30 per cu. ft. of displaced air for the 6 x 6-in. size having a capacity of 40 cu. ft. to \$3.10 per cu. ft. for the 12 x 12-in. size, having a capacity of 310 cu. ft., and to \$2.50 per cu. ft. for the 24 x 24 x 24-in. machines, having capacities of 1,150 cu. ft.

Cost of Installing a Compressor Plant. The following is an itemized account of the cost of installing a small compressor plant. The compressor was a Rand, Class C, 24 x 30-in., that cost

STEAM AND COMPRESSED AIR POWER PLANTS 239

\$1,000. The boiler was a second-hand 150 hp. locomotive boiler that cost \$1,000. This plant was capable of furnishing 1,300 cu. ft. of free air per min. at 80 lb. pressure, or enough to run 10 or 12 drills. Cost of installing boiler:

22 days laborers, at \$1.50	\$ 33
23 days engineers, at \$3	69
13 days mechanics, at \$4	52
13 days mechanics' help, at \$2	26
1 day bricklayer, at \$4	4
Total	\$184

Cost of installing compressor:

120 days laborers, at \$1.50	\$180
4 days engineers, at \$3	12
22 days mechanics, at \$4	88
80 days mechanics' help, at \$2	160
50 days carpenters, at \$3	150
3 days bricklayers, at \$4	12
6 days teams, at \$4	24
8 days foremen, at \$3	24
Total	\$650

Cost of materials:

15M lumber for housing compressor, at \$25	\$375
1,400 sq. ft. tar paper (1 layer)	21
32 cu. yd. concrete, at \$4	128
5M brick, at \$7	35
6 bbl. cement, at \$2	12
Sand	1
Total	\$572

Cost of Compressor Plants for Mines. Mr. J. D. Cone gives (*Mines and Minerals*, Oct., 1906) the cost of two-stage compressors with a capacity of 1,000 cu. ft. of free air per min. as follows:

Simple steam noncondensing, with boiler plant	\$ 9,400
Simple steam, condensing, with boiler plant	9,900
Compound steam, noncondensing, with boiler plant	9,430
Compound steam, condensing, with boiler plant and condenser	9,750
Electric, with motors and transformers	6,500
Electric, with direct current motors	5,500
Gas engines with producer	11,850
Gas engines from blast furnace gas	10,100

The above costs given by Mr. Cone are all high, from which it may be inferred that they apply to permanently housed plants in rather inaccessible regions.

Cost of a Large Compressor Plant. An air compressor, electric generating, and pumping outfit was installed for the Water Board of the City of New York at Cornwall Landing on the Hudson River, about 2,000 ft. south of the West Shore Railway Station. This plant was used to supply air for drills, pumps and general shaft and tunnel work, in driving the Catskill siphon under

the Hudson River. It consisted of: Two $\frac{16}{28} \times \frac{25\frac{1}{4}}{16\frac{1}{4}} \times 16$

Class "H.II.-3" cross-compound steam driven air compressors, each of the two having a capacity of 1,392 cu. ft. air per min., designed to operate condensing; air pressure 100 to 110 lb.; steam pressure 150 lb.; built by the Ingersoll-Rand Co. One 48-in. improved type of vertical after cooler. One 54-in. diameter by 12 ft. vertical height air receiver.

Three 130-hp. Sterling boilers; two 6 x 4 x 6 outside packed boiler feed pumps built by the Buffalo Steam Pump Co.; two 6 x 5 $\frac{1}{4}$ x 6 piston type tank pumps built by the Buffalo Steam Pump Co.; one 10 x 18 x 10 independent jet type condenser built by the Buffalo Steam Pump Co.; one 400-hp. enclosed Berriman type feed-water heater; one 20-k.w. Kerr steam turbine generating set, built by the Atwood Reardick Co.; one station panel complete with switches, etc.; one feed-water tank; 2,500 ft. of 6-in. black wrought pipe; 2,500 ft. of 1 $\frac{1}{2}$ -in. 2-conductor cable.

The above equipment was installed on rented property on the river and immediately adjacent to the railroad right-of-way. It cost approximately \$35,000, including the cost of the railroad siding, building and foundations, piping in power house, boiler setting, together with all labor and other charges for putting this equipment into operation, laying the air pipe from plant to shaft, some 2,400 ft. distant, and electrical connections between shaft and power house, well to obtain feed water and making proper connections to the river with the strainer for condensing and circulating purposes. This \$35,000 includes the following costs: Compressors, after cooler and receiver, approximately \$13,500, or about \$4.85 per cu. ft. of air per min. Balance of equipment consisting of boilers, pumps, 20 kw. generator set, water-tank, pipe and electrical conductor, about \$10,000. Railroad siding, building and foundations, piping in power house, boiler settings, well, erecting stacks, labor, superintendence, charges for placing plant in operation, rental of the site, lease for railroad siding, and incidentals, \$11,500.

Cost of a Floating Compressor Plant. The following plant was used to supply air during the construction of a caisson and its sinking by the pneumatic process. (See *Engineering and Contracting*, May 8, 1907.)

A scow 30 ft. x 80 ft. x 4 ft. was built and was equipped with 3 boilers having an aggregate capacity of 125 hp. There were 2 air compressors; 1 air receiver; 1 duplex Knowles pump, with 12 x 18-in. cylinders and 6-in. discharge; 1 small pump for supplying water into the receiver; 3 air locks, 4 ft. diameter by 8 ft. high; 8 sections main air shaft, 3 ft. diameter by 8 ft. high; 2 hoppers, 3 ft. diameter by 2 $\frac{3}{4}$ ft. high, for 18-in. supply shaft; rubber hose, various iron pipes, etc.

The three boilers, two air compressors, pump, etc., cost about \$4,000.

The scow was 30 x 80 x 4 ft., provided with a boiler house, and its cost was:

30,000 ft., B. M., timber in scow at \$15	\$450
1,400 lb. boat spikes at 4ct.	56
800 lb. bolts, screws, etc., at 3ct.	24
2,000 lb. oakum at 4ct.	80
5 bbl. tar at \$5	25
Miscellaneous materials	20

Total materials in scow

22,000 ft. B. M., in boiler house at \$15	\$330
1,200 lb. nails, etc.	40
800 lb. tarred paper at 2½ct.	20
1,000 brick	8
1 bbl. lime	1
Miscellaneous materials	10

Total materials in boiler house

Labor building scow and boiler house:

15 days, foreman, at \$4	\$ 60
240 days, carpenters, at \$3.00	720
50 days, laborers, at \$2	100

Total labor

This labor cost is equivalent to \$16 per 1,000 ft., B. M., of timber in the scow and boiler house. The cost of setting up the boilers, compressors, etc., was as follows:

12 days, foreman, at \$4	\$ 48
24 days, carpenter, at \$3	72
4 days, machinist, at \$5	20
3 days, blacksmith, at \$3.33	10
50 days, steam fitter, at \$3.50	175
24 days, engineman, at \$3.50	84
270 days, laborer, at \$2	540

387 days. Total

This cost is excessive and indicates very poor management.

The freight on this plant was \$150. Summarizing, we have:

Scow and boiler house	\$1,950
Setting up boilers, etc.	950
Freight	150

Total

Comparison of Cost of Compressing with Steam and Electricity. The cost of compressing air at Rossland, B. C., is given by Mr. William Thompson, (*Compressed Air Magazine*, Nov., 1904). Forty miles distant from the compressor plant is an immense water power generating an electric supply. Adjacent railways rendered the transportation of machinery and fuel comparatively cheap.

The steam plant erected for the LeRoy Mining Company consisted of the following: Two 250-hp. Heine water-tube boilers

for burning coal. They were arranged to work if desirable in connection with nine 125-hp. return-tube boilers designed to operate the hoisting and surface plant. During the test hereafter described the water-tube boilers were used at a gage pressure of 150 lb. and used coal costing \$5.55 per ton of 2000 lb., laid down in front of the boilers. The steam driven air compressing plant, consisted of two compound condensing Corliss-valve engines, direct-connected to 2-stage air cylinders equipped with intermediate cooling devices. These machines each had a rated capacity of 4,000 cu. ft. of free air per min. or a combined capacity of 8,000 cu. ft. of free air per min. at sea level. These engines had strokes of 48 in. and cylinder diameters as follows: High pressure steam 22 in.; low pressure steam, 36 in.; high pressure air, 22 in.; low pressure air, 36 and 38 in. They were equipped with intercoolers of the horizontal multitubular type and compressors of the independent jet type.

The electrical driven air compressing plant erected for the Rossland Great Western Mines was originally intended to operate in connection with the steam plant previously described, in order to supply power to four mines owned by different companies. Water for condensing and cooling purposes could not be secured without heavy expenditure and only two units of the plant were erected. The electrical driven plant then erected consisted of a 3-phase motor designed for 2200 volts with a rated capacity of 660 kw. equivalent to about 825 hp. The driving pulley was 60 in. in diameter, grooved for twenty-two 1½-in. ropes and running at a speed especially designed for constant service. The average results of 30 days tests are as follows:

Work Performed by Steam Plant:

Average indicated horse power at steam cylinders of the combined machines	730
Free air compressed per min. from atmospheric pressure to 95 lb. per sq. in., cu. ft.	5,432
Average horse power required at steam cylinders to compress 100 cu. ft. of air per min. to gage pressure	13.4
Coal consumed per day of 24 hr., lb.	36,400
Average lb. of coal consumed per hp. per hr. during test	1.9

Work Performed by Electric Plant:

Average horse power registered at switchboard	540
Free air compressed per min. from atmospheric pressure to 95 lb. gage pressure, cu. ft.	3,319
Average horse power required at motor to compress 100 cu. ft. of free air per min. to 95 lb. gage pressure	16.3

Monthly Cost of Operating Steam Plant:

	Total	Per hp.
Fuel, at \$5.55 per 2,000 lb.	\$2,880	\$3.96
Wages	710	.97
Oils, waste, etc.	147	.20

Total cost for 30 days (24 hr.) exclusive of interest, maintenance and depreciation \$3,757 \$5.13

STEAM AND COMPRESSED AIR POWER PLANTS 243

Wage and fuel cost for each 100,000 cu. ft. of free air compressed to 95 lb.	\$1.56
Wage and fuel cost of air per drill shift	1.25
NOTE. 80,000 cu. ft. taken as the average consumption per shift of one 3¼-in. drill.	

Monthly Cost of Operating Electric Plant:

Electric current, 540 hp. at switchboard	\$1,745
Wages	270
Oils, waste, etc.	73

Total cost for 30 days (24 hr.), exclusive of interest, maintenance and depreciation		\$2,087
Wage and electricity cost per hp. per month		\$3.87
Wages and electricity for each 100,000 cu. ft. of free air compressed ...		1.46
Wages and electricity for air per drill shift		1.17

Water Driven Compressors. An ordinary power-operated compressor may have the belt wheel replaced by a heavy rim carrying buckets upon its periphery thus changing the belt-drive wheel into a water wheel. Impulse wheels and turbine wheels are more often used. The efficiency of various water motors is about as follows:

	Per cent.
Impulse wheels	70 to 85
Turbine wheels	75 to 85
Overshot wheels	60 to 65
Breast wheels	50 to 60
Undershot wheels	30 to 50

With either high or low head the turbine wheel is economical, but it can only be used with clear water, as sand or grit cut the vanes and casings. Impulse wheels, particularly the Pelton wheel, are in wide use. These are driven by a stream of water directed through a nozzle against buckets on the periphery of the wheel. When small wheels are required for obtaining the requisite speed a number of nozzles may be substituted for a single large one.

A 30-ft. Pelton wheel driving a 300 hp. two-stage air compressor is used at the North Star Mine, California. This compressor has four cylinders, each single acting and each measuring 30 and 18.5 by 30 in. In order to reduce the cost of foundations the cylinders are set at an angle of 30 degrees to the horizontal. The wheel makes 65 rev. per min. under a head of 775 ft. the water being obtained through a single 1¼ in. nozzle. At the Morning Mine, Idaho, a Pelton wheel, 33 ft. in diameter, is driven by water acting under a head of 1400 ft. There are four cylinders in the compressor, a high and a low pressure cylinder being set tandem on each side of a set of three Pelton wheels, one 33 ft. in diameter and two 12-ft. in diameter mounted on the crank shaft. Each pair of cylinders is 33.5 and 18 in. diameter by 42 in. stroke, and works at a piston speed of 5600 ft. The air is compressed in the low pressure cylinders to about 30 lb. and in the high pressure to about 90 lb. Efficient cooling is obtained

by placing inter-coolers and after-coolers in the tail races of the smaller wheels. The machine is highly efficient.

Air Compression by the Action of Falling Water. The Taylor System, developed by Mr. Chas. H. Taylor, is the best known example of this method. The principle under which this system operates is as follows: If a stream of water is allowed to fall swiftly, while suitably confined in a vertical pipe, any air mixed with the water just previous to its downward motion is compressed. If then the movement of the flow is suddenly changed to a horizontal direction and the velocity lessened the air will rise in and above the water and may be collected in a suitable retainer.

The Taylor plant at Cobalt, Ontario, is situated at a point on the Montreal River where there is a drop of about 54 ft. in one quarter of mile of the stream. At the head of these falls two steel-lined shafts, each 360 ft. deep, were constructed. A 20 x 26-ft. tunnel, 1,000 ft. long, connected these shafts with an upraise-shaft, 298 ft. deep and 22 ft. in diameter, at the foot of the rapids. Water flowing into the intake-head is combined with air admitted to sixty-six 14-in. pipes set in an encircling ring in each head. The 16-ft. intake-head pipes reduce to 8.5-ft. diameter almost to the bottom of the shaft, where they enlarge to 12.5-diameter. The water and its entrained air flow through the head with a velocity of 15 to 19 ft. per sec. This velocity gradually reduces until it is such that when the water strikes the diverting-cone at the bottom of the shaft it does so with very little shock. This cone changes the movement of the flow to a horizontal direction and the compressed air rises to the surface of the water under a pressure of 120 lb. per sq. in. The difference in elevation between the mouths of the intake and outlet tunnels is 47 ft. The velocity of the water in the tunnel is about 3 ft. per second.

The plant develops about 5,800 hp. and compresses 40,000 cu. ft. of free air per min. The air is reduced to 100-lb. pressure and conducted to Cobalt in 9 miles of 20-in. pipe, at the end of which are two 12-in. branches, with another 12-in. branch 7 miles from the plant. The total length of 20, 12, 6, and 3-in. piping is about 21 miles. The large piping has welded joints with a sliding expansion joint every half mile. The total cost of the plant exclusive of the transmission lines was estimated at \$1,000,000, or \$200 per hp.

The air is practically perfectly dry but partially deoxygenated which prevents the use of candles for lighting.

The Taylor plant at Ainsworth, B. C., has a hydrostatic pressure of 200 ft. and an air pressure of 85 lb. per sq. in., compresses 5,000 cu. ft. of free air per minute and develops 500 hp.

The available head of water is 107.5 ft. The downflow pipe is 33 in. in diameter, and the shaft has an area of 32 sq. ft. and is 210 ft. deep. The cost of the plant was about \$35,000 or \$70 per hp.

Another plant in the State of Washington developed 200 hp., the air pressure was 85 lb., and the head of water 45 ft. No shaft was used but the diameter of the down-flow pipe was 3 ft. and of the up-flow pipe 3 ft. 4½ in. The flow of water was 2,000 miners' inches of water or 53.2 ft. per second. The total height of the plant was 260 feet.

The plant at the Victoria Mine, Michigan, compresses 36,000 cu. ft. of free air per min. There are three vertical down-shafts, 15 ft. in diameter and 343 ft. deep, and the sloping up-shaft has a vertical height of 271 ft. The air storage chamber has a capacity of 80,000 cu. ft. of compressed air. The air pressure is 118 lb. and the efficiency of the plant is 82%. The cost of the compressor and accessories was about \$22 per hp., and the cost of the dam and the canal about the same. The cost of power, including 5% interest on the investment, was \$2.25 per hp.-year.

The plant at Norwich, Connecticut, develops 1,365 hp. The air pressure is 85 lb., and the head of water 18.5 ft. The depth of shaft is 298 ft., and the diameter is 24 ft. for 160 ft. down and 18 ft. for the remainder of the depth. The diameter of the compressor pipe is 14 ft.

The plant at Peterboro, Ontario, has a head of water of 14 ft. The diameter of the compressor pipe is 18 in. and the diameter of the shaft 42 in. The depth of the separating chamber below the tail race is 64 ft. The gage pressure of the air is 25 lb.

The plant at Magog, Que., develops 150 hp., the head of water being 22 ft. The return-water column is 120.5 ft. high and determines the air pressure of 52 lb. per sq. in. The diameter of the water supply pipe is 5.5 ft., the diameter of the down flow pipe is 3 ft. 8½ in., and the air compressing chamber is 17 ft. in diameter by 10 ft. (average 6 ft.) high. The depth of shaft is 128 ft. and is 6 x 10 ft. in size. Tests made at Magog, Aug., 1896, showed that with a quantity of water discharged varying from 4,005 cu. ft. per min. to 7,662 cu. ft. per min. and an available head of water varying from 21.1 ft. to 22.3 ft., the plant had an available horse power varying from 169 to 306, and delivered a quantity of air varying in amount from 1,095 cu. ft. per min. to 1,611 cu. ft. per min. at atmospheric pressure.

The pressure of the air in compression was 52 lb. and the actual horse power of compression varied from 105 hp. to 155 hp. The efficiency of compression varied from 50% to 62.4%. The temperature of the external air during the test varied from

75 to 83 degrees, and of the compressed air from 75.2 to 80 degrees.

Comparative Cost of Compressing Air by Water Wheel, by Electric Motor and by Hydraulic Compressor. Mr. P. Bernstein gives the cost of a hydraulic air compressor installed (1907) at Clausthal, Germany. It replaced a piston compressor driven by a Pelton wheel. The method of hydraulic compression is somewhat similar to that of the Taylor system. Water is run through a cast-iron pipe of about 218 mm. to an air-suction pipe and the combined fluids are then passed through an almost vertical pipe 218 mm. in diameter and 150 m. high. The water discharges through the bottom of a receiver, 1.1 m. in diameter and 4.5 m. high, located at a point 52 m. below the level of the overflow pipe. The air is separated from the water in the receiver and is passed through a valve into an 80-mm. pipe to the working places of the mine. The overflow water passes up through a pipe 280 mm. in diameter and 50 m. long. The average flow of water through the system was found to be 3 cu. m. per min. which, falling through the distance 99.3 m. between the intake and discharge levels, yielded 4500 kg. m. per min. or 66.2 hp. In a test it was found that 3.2 cu. m. of water per min. falling 99.3 m. afforded 10 cu. m. of air per min. at the affective pressure of 90 lb. per sq. in. The work affected was therefore equivalent to 54 hp. and the theoretical power of the water was 70.5 hp., giving an efficiency of 77%.

The turbine wheel installed had an efficiency of about 75% and the compressor an efficiency of 85%, the combined efficiency being 64%.

In the following tables are compared the cost of compressing air by three different means: (1) By a piston compressor belt-driven from a water turbine consuming the same amount of power as the hydraulic plant; (2) by an electric driven compressor of the same capacity and using the same amount of power; (3) by hydraulic installation.

1. *Water driven plant.*

Investments:

Belt driven compressor	\$1,250
Pelton wheel, complete	1,125
Building foundations, etc.	450

\$2,825

Interest and Depreciation:

Interest on plant at 5%	\$ 141
Depreciation of machines at 10%	238
Depreciation of building at 3%	15

Operating Expenses:

Wages (night and day shifts)	600
Lubricants, $\frac{1}{2}$ lb. per hr.	75
Repairs and waste	75

Total annual cost

\$3,144

STEAM AND COMPRESSED AIR POWER PLANTS 247

Assuming 6,000 working hours per year and an output of 7.8 cu. m. per min., the year's output by the above arrangement would cost \$0.38 per 1,000 cu. m.

2. *Electric-driven Plant.* Assuming the efficiency of the plant to be 0.90; of the belt or gear drive, 0.95; of the motor, 0.90; and of the current transformer, 0.95, the total efficiency of the electric-driven plant would be 73%, and for the generation of 54 hp. would require the purchase of 74 hp. from the central generating station.

Investments:	
Belt driven compressor	\$1,500
Electric motor, 70 hp.	1,200
Buildings, foundations, etc.	450
	\$3,150
Interest and Depreciation:	
Interest on plant at 5%	\$ 158
Depreciation of machines at 10%	315
Depreciation of building at 3%	15
Operating Expenses:	
Wages (day and night shift)	600
Lubricants	95
Repairs and waste	100
Electric power, 74 hp. for 6,000 hr. at 1/2 ct. per hp. hr.	2200
Total annual cost	\$3,503

With an output of 10 cu. m. per min., the year's output by the above arrangement would cost \$0.98 per 1,000 cu. m.

3. *Hydraulic Compressor.*

Investment:	
Compressor installed	\$3,750
Interest and Depreciation:	
Interest at 5%	187
Depreciation at 5%	188
Operating Expenses:	
Lost wages during shut-down	30
Repairs	20
Total annual cost	\$ 425

With an output of 10 cu. m. per min., the year's output by the hydraulic compressor costs only \$0.12 per 1,000 cu. m. It may be added that 10 cu. m. of air, at 5.1 affective atmospheres, is equivalent to 353 cu. ft. at a pressure of 90 lb. per sq. in.

The foregoing cost estimates are all low, even for Germany.

Gasoline Air Compressors. One pint of gasoline per hour per brake horse power (b.hp.) of engine may be counted upon as the average consumption. It will require about 12 hp. to compress air for each 3/4 in. percussive drill; hence 12 pints, or 1 1/2 gal., of gasoline will be required per hour per drill while actually drilling. Since gasoline air compressors are self regulating, when the drill is *not using* air very little gasoline is burned by

the gasoline engine driving the compressor. If the drill is actually drilling two-thirds of the working shift, we may safely count upon using about 1 gal. of gasoline per hour of shift per drill, or 8 gal. per shift 8 hr. long. If gasoline is worth 15 ct. per gal., delivered at the engine, one drill consumes only \$1.20 worth of gasoline per shift of 8 hr. In shaft sinking, tunnel work and the like, as will be shown later, a drill is often idle two-thirds of the shift, so that the gasoline consumption would be still less.

A gasoline compressor possesses very important economic advantages over a small steam-driven plant. First, there is the saving in wages of firemen; for, once started, a gasoline engine runs itself. Second, there is the saving in hauling or pumping of water and the hauling of fuel. Third, the cost of gasoline is often less than the cost of coal for operating a small plant. The Golden Wave Mine, Congress, Ariz., used a 30 hp. gasoline driven compressor (Fairbanks-Morse) for sinking an incline, at a cost that was remarkably low. I believe this type of plant is destined to find an increasing field of usefulness. It is especially adapted for rock trench excavation in cities, for tunnel work and for open cuts where only a few drills are operated.

Small Portable Air Compressor. (*Engineering and Contracting*, Jan. 6, 1915.) A small gasoline driven portable air compressor has been developed by the Ingersoll-Rand Co. to meet the needs of a contractor doing work of a temporary character requiring compressed air in small quantities. The compressor is operated by a simple single cylinder gasoline engine which is coupled directly to the compressor, both pistons working on the same crank shaft. The engine is of the single acting two cycle type, closely following the well known marine designs. The air compressor, which is one of the company's standard types, known as "Imperial XII," has a capacity of 45 cu. ft. per min. at a pressure of 90 lb.; it is fitted with an air unloader and the engine with a centrifugal governor. Cooling is provided for by a gear driven pump and an automobile type radiator with large tank capacity, serving both the compressor and engine. The radiator is assisted by a large fan.

An air receiver tested to 300 lb. water pressure and fitted with safety valve, pressure gage, necessary piping, outlets, etc., is hung at one end of the frame and a gasoline tank of 15 gal. capacity is supported on a large tool box as shown in Fig. 46.

The outfit complete weighs 1,600 lb.: it is designed for hand transportation, but can be fitted with tongue and singletree if desired. The makers rate this outfit in terms of pneumatic tools of its make as follows: Three medium size "Little David" chippers; two "Crown" pneumatic picks; two "Little David"

riveting hammers; one "Little David" wood boring drill or one metal drill; two "Crown" sand rammers; two small plug drills or one jackhammer; one medium size "Imperial" hoist; ten small stone tools or six larger sizes.



Fig. 46. A Portable Gasoline Driven Air Compressor.

Make	Cu. ft. free air per min.	At press. of, lb.	Weight lb.	Type compressor.	Motive Power.	Price.
Abenague	78	100	7,700	8x8 Ing.-Rand "NE-I" single stage water jacketed.	15 hp. 1 cyl. Abenague gasoline.	\$1,425
Abenague	64	100	7,800	6x8 Franklin single stage water jacketed.	do.	\$1,325
Chicago Pneum. Tool Company	70	90	7,000	6x8 Franklin single stage water jacketed.	1 cyl. gasoline.	\$1,250
Fairbanks Morse	70	80	8,900	8x8 Fairbanks Morse.	12 hp. 1 cyl. gasoline.	\$1,120
Bury	94	90	9,000	9x8 Class B. B. Bury.	20 hp. gasoline 1 cyl.	\$1,825
Nat'l Brake & Elec. Co.	100	90	8,000	7½x9 Nat. Brake & Electric.	3 cyl. marine type 27 hp.	\$1,900

Prices of Portable Gasoline Air Compressors. There are a number of small, light, portable electric or gasoline motor driven compressors now on the market. These machines are able to furnish sufficient air to drive two or three small hammer drills, and some of the larger machines are capable of driving a small percussive drill. Mr. Colin C. Simpson, Jr., in the *Journal American Gas Institute*, 1910, gives the foregoing net prices relative to several types of portable compressors.

Repairs and Depreciation of Power Plants. The term "repairs" is best restricted to the current maintenance, that is to the renewals of *parts* of a given "plant unit" (such as the flues of a boiler), and to other upkeep expenditures short of the renewal of an entire "plant unit." By "plant unit" is commonly meant one of the individual machines consisting of renewable parts, such as a boiler or an engine.

The term "depreciation" is best restricted to the loss of value resulting from the replacement of an entire "plant unit." Depreciation of most machines is seldom caused through wear and tear, but because they are no longer needed by the owner or because a larger or more modern machine is preferable.

The "repair costs" on electric light power plants average about 2% per annum, but the "depreciation cost" has averaged 6% per annum in most cities, often running much higher. Such plants are operated day and night, the "load factors" averaging about 35%, which is equivalent to operating at full capacity for 35% of the time.

I would estimate the annual repair cost of a compressor plant at about 1.5% working one shift daily, 2.5% working two shifts, and 3% working three shifts. The depreciation percentage should rarely be estimated at less than 10% per year, and if the mine is to have a short life, or if the construction plant is likely to be sold "second hand" at the end of the job, very much higher percentages of depreciation should be assumed.

Calculate the monthly cost of "repairs" at about 0.2% per month of two-shift work. Then to this add the annual depreciation, say 12%, divided by the number of months of probable working time in the year. If the work is outdoors, and of a character such that 6 mos. is likely to be an average working season, we then have $12 \div 6 = 2\%$ per month depreciation, to which add 0.2% for repairs, or a total of 2.2% per month for upkeep and depreciation.

Repairs on new machinery cost less than on old machinery, but the above percentages for repair costs apply to machines of "average age," say 6 years old.

Interest, at 6%, and taxes and insurance, at 2%, make about 8% additional "fixed charges." If the plant is to work only 6

mos. per year then interest and taxes will cost 1.33% per month actually worked.

I give these rather elementary calculations because many engineers forget to make allowance for idle plant time in calculating monthly or daily costs of fixed charges. Many engineers estimate "depreciation" cost and forget current "repair" costs, or vice versa.

Drill repairs and depreciation costs are very much higher percentages than those for power plants (see Chap V).

Cost of Compressed Air. The total output of all the air compressor plants employed on the Panama Canal work during the year ending June 30, 1910, was 7,227,203,513 cu. ft. of free air and the average cost was 4.03 ct. per 1,000 cu. ft.

CHAPTER VII

CABLE DRILLS, WELL DRILLS, AUGERS AND COST DATA

Cable Drills for Blast Hole Work. Well drills of the cable type have come to be used quite extensively in open cut rock excavation. Most of the data in this chapter relate to the use of cable drills for blast holes, but true well drilling also receives some consideration.

Well drills (cable type) were first used for blast hole drilling in 1902 on railway excavation near Harrisburg, Pa. I studied their operation and the resulting costs there and published the data in 1903.

Methods of Well Drilling. There are three general methods of driving well holes: Hydraulic, percussion and abrasion methods. In almost all well driving and prospecting operations, the rock is overlaid by a more or less thick coat of earth and surface materials, and it is therefore sometimes necessary or economical to use hydraulic or wash-boring methods, with a casing of pipe for penetrating to the bedrock. Methods and costs of making wash-borings are to be found in my "Handbook of Earth Excavation." The abrasion methods are fully described in Chapter VIII. Augurs are also used in prospecting in the softer rocks and in coal, and examples of the use and cost of boring by hand are given at the end of this chapter.

Types of Percussion Well-Drilling Machines. There are many types of cable well-drilling machines or rigs in use, ranging from the "standard rig" having a pyramidal framework or derrick sometimes as high as 100 ft., to the small homemade, hand operated well drill with a simple tripod for a derrick.

The Standard Rig. This consists of a 4-legged steel or wood derrick, 30 to 100 ft. high, erected over the proposed hole, well braced, over, which the drilling cable passes. Other essential parts of the machine are the "bull wheels" and reel on which the cable is wound, the brakes, the walking beam by which the cable and tools are raised and lowered, and the driving mechanism.

The size of the parts of a rig depend on the amount and difficulty of the work to be done. In one case for a well 2,000 ft. deep the derrick was 72 ft. high. For wells from 2,000 to 3,000

ft. deep the derrick was 82 ft. high. An increase in the length and weight of tools used is always accompanied by an increase in the size and strength of the derrick. The stems alone of the drills used with the 82 ft. derrick were 39 to 42 ft. long, and the sand buckets used with some outfits are 60 ft. long. The walking beams were 16 and 24 ft. long for the 72 and 82 ft. derricks, respectively.

Well derricks are usually made of wood, though structural steel has been used in some cases. A bolted wood or steel derrick may be set up in two or three days. Three or four skilled workmen can set up an ordinary nailed derrick in from 3 to 5 days, the

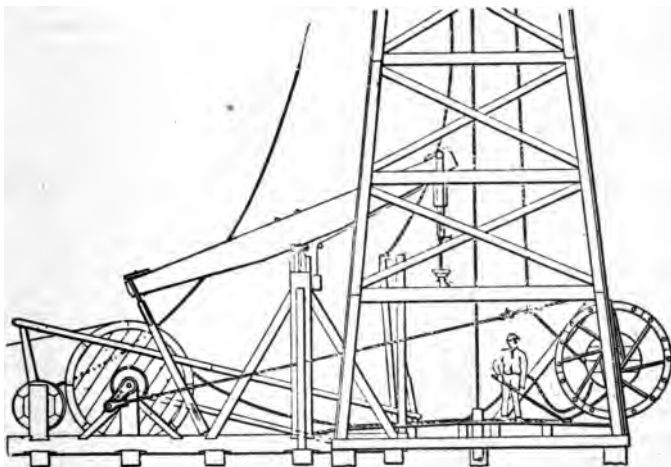

Fig. 47. Standard Rig Arranged for Spudding.

time depending on the size of the rig and the quality and accessibility of the lumber. Wood for a nailed derrick can be used in two or three derricks before becoming badly split and worn out.

Power. Steam power is almost universally used and is supplied by a boiler placed a short distance from the engine. The power is transmitted from the engine to the band wheel of the rig by means of a belt. Ordinarily the throttle is moved by wires from the derrick and the reverse lever is similarly operated by a man at the well by means of a rod from the derrick to the engine.

Cost. The regular standard outfit, including rig, power, and tools, in the Pennsylvania oil fields costs from \$1,700 to \$3,000 or more. A 72-ft. derrick with reels and ironwork costs \$600

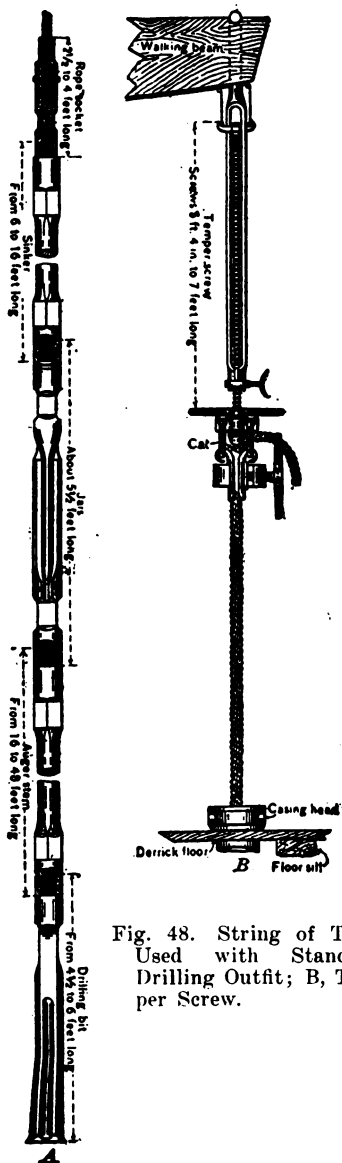

Fig. 48. String of Tools Used with Standard Drilling Outfit; B, Temper Screw.

to \$750. The boiler employed varies from 15 to 40 hp. and the engine from 12 to 30 hp., the size depending on the depth to be drilled; the two cost between \$600 and \$900. The necessary tools usually cost about \$500, though fishing tools and other extras may involve an aggregate expenditure for the outfit of as much as \$4,000.

The average cost of oil well casing ranges from 40 to 50 ct. a ft. for 4-in. to about \$2 a ft. for 12-in., though the price varies with the iron market and with the freight charges.

In the Gaines oil field of northern Pennsylvania, where drilling sometimes proceeds at the rate of 70 ft. in 24 hours, through shakes and shaly sandstones and limestones, drilling is done by contract at about 65 ct. a ft., the cost of casing being additional.

In the Coalinga oil district in California, where water for drilling forms an extra item of expense, the average cost of a 4,000-ft. well has been estimated at \$7,500, divided as follows: Land and water, \$1,500; casing, \$2,500; outfit, \$3,500. Many of the deep wells in this district, which start with a casing 11½ in. in diameter, greatly exceed this average cost, however.

In the Summerland oil district of California wells 6 or 8 in. in diameter at the top and about 250 ft. deep are put down at a cost of about 85 ct. a ft. for drilling only.

A homemade churn drill which cost but \$25, is described by Mr. Otto Ruhl in *Engineering and Mining Journal*, Oct. 28, 1911. This machine was able to drill to a depth of 100 ft., but the progress in the last 10 ft. was very slow. From 30 to 60 ft. per week could be drilled. Estimating one man and horse at \$4 per day the cost would be from 40 to 90 ct. per ft.

Pole-tool Method. This differs from the standard method chiefly in that wooden rods, instead of a cable, are used for raising and lowering the tools. In very wet holes the friction of a thousand or more feet of hemp rope in water greatly reduces the force of the blow and the cost of casing off the water in a wet hole usually exceeds the extra labor cost of pole-tool drilling. The cutting tools strike a dead blow and not a springing blow as with the cable tools. A derrick usually 60 ft. high and 16 ft. square, resembling the standard derrick, is used. It takes 10 days to set up and 2 to 4 days to take down a derrick of this kind.

Hollow Rod Method. The tools consist of a string of pipe with screw couplings, with a water swivel at the upper end and a drill bit at the lower end. A reel is revolved and the drill is raised and lowered by tightening and loosening the cable. Water is continuously pumped into the hole to wash out the cuttings. This method is adapted to sinking holes of small diameter in sand, clay, soft limestone and other easily penetrated materials. *It is often used in prospecting for coal. Machines built especially*

for hollow-rod tools, complete with horsepower attachment, tools and 100 ft. of rods, cost from \$225 for 2-in. bits to \$325 for 5-in. bits. The price of the outfit equipped with a 5 or 6 hp. engine and boiler is from \$650 to \$800. The cost of drilling averages about 20 or 30 ct. per ft. in soft materials.

Portable Well Drill Rigs. This type of well-driller is the one most suited to work either in prospecting or for drilling blast holes. These machines are made by a number of manufacturers, and while of the same general design, differ principally in the method of operating the tools by cable or by rods, in the arrangement for spudding, and in the size and weight of the machine and tools. The machines are usually mounted on wheels and are moved by horses or by hand or are auto-tractive. A six-horse team will handle a No. 4 Keystone machine weighing 12,000 lb., and a ten-horse team will handle a No. 5 machine weighing 18,000 lb. Most traction drills are capable of climbing grades as heavy as 25 or 28% for distances of 200 ft., but grades should be kept down to not more than 15 to 18%, where possible.

The total weight of a machine ranges from 5,000 to 34,000 lb., but the size in general use by contractors averages about 12,000 or 15,000 lb. Fig. 49 illustrates a portable machine equipped with a cable for operating the tools. Table XXXII gives the size of portable rigs.

Price of Cable Drills. Machines capable of driving a hole 200 ft. (see Table XXXII) cost about \$700 to \$800; those of 500 ft. capacity cost \$1,000 to \$1,300; and with traction attachment about \$300 extra. Machines capable of drilling 1,400 to 2,600 ft. cost from \$1,600 to \$2,500. The foregoing costs include machinery and power equipment. Three No. 5 Keystone drills (see Table XXXII) with a complete outfit of extra parts and tools cost, in 1907, about \$1600 each. In general, the price is about \$1,500 per ton of weight (see Table XXXII for weights) for the larger sizes of 10 tons or more in weight.

Advantage of Traction. The interest, depreciation and repairs on a \$350 traction attachment will amount at 6, 10, and 15%, respectively, or \$108 per year. This will be from 54 ct. to \$1.08 per day for machines working from 100 to 200 days per year. If the cost of drilling is 15 or 20 ct. per ft. of hole it will be necessary for a well drill to do from 3 to 7 ft. per day additional to justify the cost of the traction equipment. If the country is extremely rough so that machines must be carefully moved by hand the traction attachment is of no use and adds to the weight. On the other hand when it can be used it is a great time saver *in moving and will materially increase the number of feet drilled per day.*

Method of Operating Well Drilling Machines. While makes

TABLE XXVII. SIZES OF WELL DRILLS

SIZES OF STAR WELL DRILLS																						
Catalog No.	15	16	17	18	19	20	21	22	23	24	25	26	27	28	30	30	19T	20T	21T	22T	23T	24T
Capacity, ft.	200	400	200	300	400	500	600	800	1000	1400	1600	2200	2600	3000	4000	400	500	600	800	1000	1400	1400
Weight of machine, tons	5	3½	4½	6	6½	7½	8½	10½	11½	13½	15	17	18½	22½	8½	9½	10½	12	13	14	15	18
Engine horsepower	5	7½	5	6½	7½	9	11	13	15	18	20	23	26	30	35	9	11	13	13	15	18	18
Size of bits, ins.	4-5	4½-6	4-5½	4-5	5-6	5-8	5-8	5½-8	6-8	6-8	6½-8½	8-8	8-8	8-8	8-8	5-8	5½-8	8-8	8-8	8-8	8-8	8-8

SIZES OF KEYSTONE WELL DRILLS

Catalog No.	1	3	3½	4	5	15	20
Capacity, ft.	250	500	400	800	1000	1500	2000
Weight, tons	6	7	6½	7½	11	16	17
Engine, hp.	6	8	11	11	14	16	18

SIZES OF CYCLONE WELL DRILLS

Catalog No.	14	14
Weight, tons	5	9

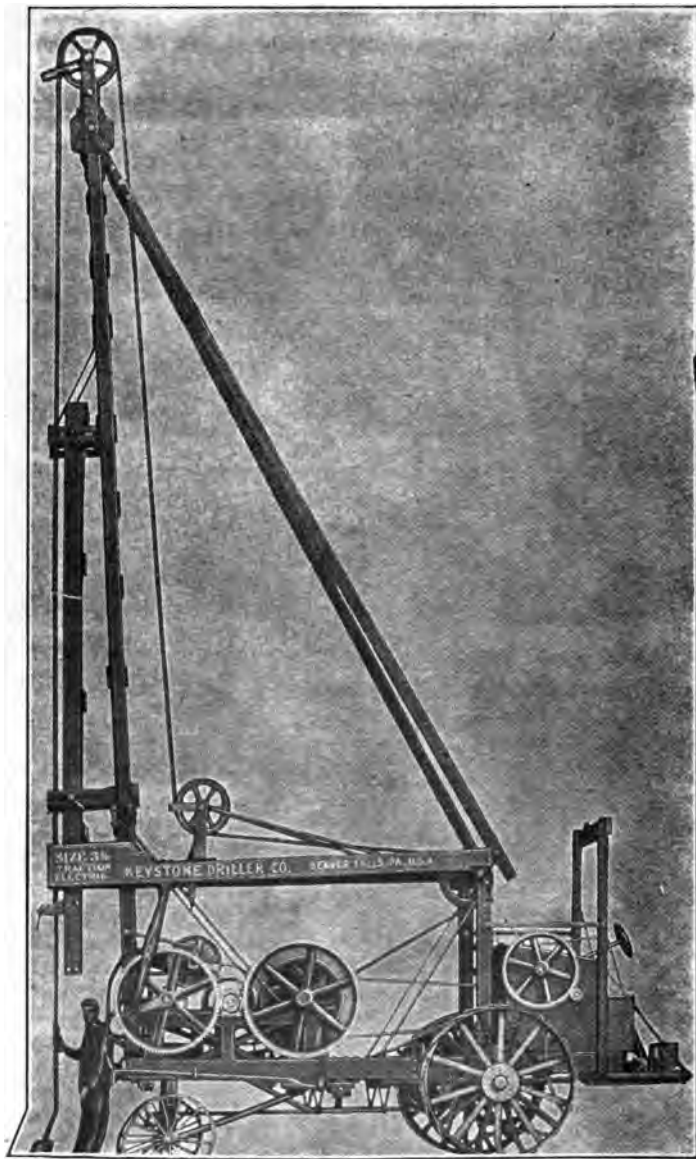

Fig. 49. Keystone Well-Drill, No. 3 $\frac{1}{2}$ Traction with Electric Motor.

of well drilling machines differ in many particulars, the general methods of setting up and operating are similar. Most manufacturers issue instruction books which should be carefully studied by operators not familiar with the particular make of machine they are to handle.

Setting-Up and Assembling. The machine having been assembled and its front end located over the proposed drill hole, the machine is carefully leveled both longitudinally and laterally. Laterally the drill may be leveled with a spirit level; longitudinally it may be leveled by using the drill cable as a plumb line. The wheels should be blocked securely. The derrick is next raised by hand or steam winch, or by hand with poles or jacks.

Spudding. This is the process (Fig. 47) of drilling without using the walking-beam and is usually continued until all the casing is in and bed rock is reached. Practically all blast hole digging is done by spudding. Spudding is very hard on both the machine and the cable.

In ordinary ground about two gallons of water will be needed to each foot of hole to suspend the cuttings so they can be lifted

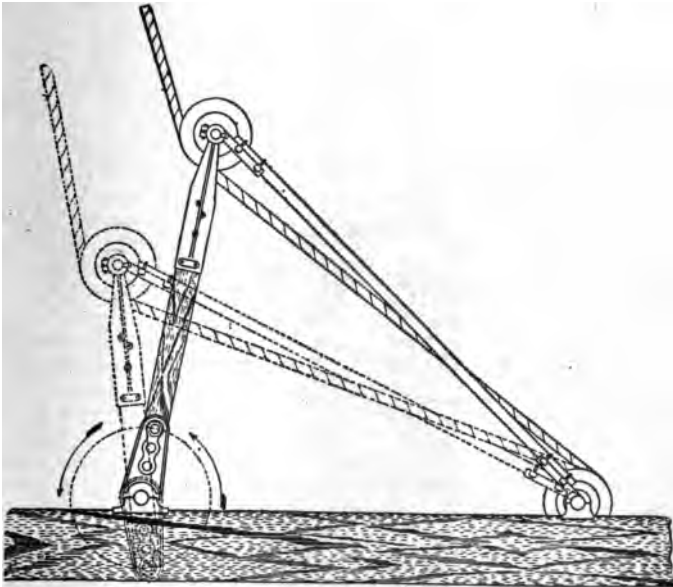

Fig. 50. Spudder on No. 14 Cyclone Drill.



Fig. 51. String of Tools
260

with a sand pump. The drill must be withdrawn every 4 or 6 ft., to permit the removal of the sludge.

In order to drill a round hole the drill must be turned constantly and regularly.

Driving Pipe. Driving the casing pipe is accomplished, after the spudding bit has drilled 20 or 30 ft. (depending on the character of the ground), by lowering into the hole a length of pipe with drive cap attached, and pounding on the drive cap with driving clamps attached to the bit. Sometimes the pipe drops into the hole without driving or may be forced down by turning and pouring water down the hole at the same time.

Using the Walking Beam. The "temper screw" is hung to the end of the walking beam and the cable fastened to the clamps in the lower end of the tools. Do not try to make the drill cut faster by letting out more cable. At 100 ft. depth the bit should hang naturally about 4 or 5 in. from the bottom of the hole and at 200 ft. about 6 or 12 in. The spring of the cable will let the bit strike the bottom of the hole.

Well Drill Bits. Fig. 51 shows a regular string of tools hung from the derrick.

Fig. 52a shows the spudding bit which is used in cutting through clay, loose stones, etc.

If a hole is to be finished 5½ in. in size, the spudding bit is usually 7½ in. Fig. 52b shows the paddle or Mother Hubbard bit.

This is used where rock is hard and seamy, or whether the strata are perpendicular or nearly so. It is almost as wide at the bottom and nearly fills the hole so that it cannot slip off sloping strata. Fig. 52c shows the fluted rock bit which is the type generally used.

Fig. 52d shows a four winged bit of a character which makes a straight round hole difficult to drive.

Fig. 52e shows how the corners of a bit should fill out a gage. The distance from A to F from C to D, and from B to E should be equal. The cutting faces of a bit for use in hard rock should make an angle of about 45 degrees with the direction of the drill stem.

Speed of Cable Drilling. In an endeavor to arrive at some definite conclusions regarding the speed of drilling through different rocks I have compiled Table XXXIII. Although there is much in print concerning the speed and cost of well drilling, there are few records which contain all the necessary facts. As will be seen from Table XXXIII, one or more of the two conditioning factors listed there is missing in many cases, and to enable one to make proper deductions many other factors should be recorded.

The effect of the size of the bit on the speed of drilling is quite



Fig. 52. Cable Drill Bits.

TABLE XXXIII. SPEED OF DRILLING WITH CABLE OR WELL DRILLS

Ft. Per Hr.	Kind of Material.	Size Hole, Ins.	Depth Hole, Ft.	Kind of Machine.	Remarks.	Authority.
10	Clay, soapstone	5 1/2	18		Blast holes. R. R. work	E. & C., 1/23/07.
9.0	Limestone	5 1/2	30	Cyclone	Cement quarry	Cyclone Bull.
8	Limestone	5	34	Cyclone	Lime and crushed rock mfg.	Cyclone Bull.
7	Limestone			Keystone, 3 1/2	Shattered ground	Keystone catalog.
6.7	Ryolite			Keystone	Prospecting	C. E. Hart.
6.4		5 1/2	40		Crushed rock quarry	Cyclone Bull.
6	Shale	5 1/2	20	Cable drill	Blast holes	Gillette.
5.7	Porphyry ore and harder	5 1/2	55	Keystone	Blast holes. Open pit mining	Keystone mag.
5.5	Limestone	5		Keystone	Blast holes, Illinois	U. S. Crushed St. Co.
5.3	Hard flint		150	Keystone	Blast holes, Missouri	Keystone catalog.
5.2	Hard, seamy basaltic	3	23	Cyclone	Blast holes, Missouri	E. & C., 6/20/08.
5.2	Soil, gravel	2 1/2	36.6	Cyclone #2		E. & C., 11/18/08.
5.1	Clay 17', shale 113', cap 87' S. S. 14'	5	67	Cyclone #4	Prospect. Soft rocks	E. & C., 9/9/08.
5.0	Solid brown S. S.	3	24	Cyclone	Ohio	W. M. Douglass.
5.0	Shale	5 1/2	50	Cyclone	Crushed rock quarry	Cyclone Bull.
4.8	Shale	5 1/2	75	Star	Blast holes	W. R. Hulbert.
4.7	10' seamy, 5' hard cap, very hard blue	5	22-30	Loomis 2G	Limestone. Blast holes	E. & C., 8/3/10.
4.5	Shale, sandstone	2 1/2	337	Cyclone #2		E. & C., 11/18/08.
4.5	Clay 17', shale 113', cap 87' S. S. 14'	5	142	Cyclone #4	Prospect. Soft rocks	E. & C., 9/9/08
4.4	1/2 earth, 1/2 slate		12	Keystone	Aqueduct, N. Y.	Blakeley & Sons.
4.2	Lime and sandstone			Keystone	Well drilling (?)	Keystone mag.
4.0	Limestone		50	Keystone	Lime mfg.	E. & C., 6/1/10.
3.9	Limestone	5 1/2	40-45		Quarry	E. & C., 11/18/08.
3.6	Soil, gravel, shale	2 1/2	39	Cyclone #2	Prospect	W. R. Wade.
3.5	Turquoise marl	4	300-700	Cyclone #4	Prospect in New Mexico	E. & C., 9/9/08
3.5	Copper ore, porphyry	6 1/2	60	Keystone #5	Mining. Blast holes	W. R. Hulbert.
2-8	Shale	4 1/2-6	20-80	Star		

<i>Ft. Per Hr.</i>	Kind of Material.	Size of Hole, Ins.	Depth of Hole, Ft.	Kind of Machine.	Remarks.	Authority.
3	25% soft slate, 75% hard limestone			Keystone	Moderately hard. Blast holes	Eng. Rec. 8/2/13.
2-2.5	Limestone			Keystone	Good conditions. Prospect	Rock Cut Stone Co.
2.1	Copper ore		412			R. Marsh, 9/9/08.
2.0	Limestone	3 1/4 *	104	Cyclone E-4C	Soft rocks. Prospect	E. & C., 9/9/08.
2.0	Limestone	3 1/4 *	158	Cyclone E-4C	Soft rocks. Prospect	E. & C., 9/9/08.
2.0	Granite			Keystones	Blast hole drilling	C. W. Blackalee.
2.1†		4 1/2-10	18	Star 23†	Hr. working time, 1-15 ft.	I. J. Stauber.
1.8	Shale	5%	235		Blast holes	E. & C., 1/23/07.
1.8	Copper ore		30-35	Star	Favorable cond'ns. Prospect	R. Marsh, 9/9/08.
1.5-2.5	Copper ore	6		Keystone core	Blast holes and prospect	E. & C., 5/3/11.
1.5-2	Black slate	5	45-85	Star	Blast holes. Cement quarry	Keystones, cat.
1.5	Limestone		230		Seamy rock	Eng. Rec. 5/18/07.
1.4	Copper ore			Keystone core	Testing coal lands	R. Marsh, cat.
1.2	Granite			Key or Star	Good conditions	Keystones, cat.
1.0	Con. trap			Keystone	Blast holes	W. G. Weber.
1.0	Hard, gneiss, mica-schist					C. W. Blackalee.
1.0	porphyry	5%	100-130	Star	Blast holes. Speed, 0.9 to 6	W. R. Hulbert.
1.0	Limestone, hard S. S.	6	20	Keystone	Prospect work	C. E. Hart.
1.0		5%		Cable drill	Blast holes	Gillette.
1.0	Schist	4 1/4-7%	230	Star T	Prospect. Copper ore	E. & C., 11/9/10.
1.1	Schist			Key or Star	Conditions, fair	W. G. Weber.
1.1	Schist			Key or Star	Conditions, fair	W. G. Weber.
1.0	Schist			Key or Star	Conditions, fair	W. G. Weber.
1.0	Granite and schist			Key or Star	Conditions, fair	W. G. Weber.
1.0	Granite			Key or Star	Conditions, fair	W. G. Weber.
1.0	Granite			Key or Star	Conditions, poor, caving	W. G. Weber.
0.9	Schist			Key or Star	Conditions, fair	W. G. Weber.
0.8	Granite and schist			Key or Star	Conditions, poor, caving	W. G. Weber.
0.8	Granite and schist			Key or Star	Conditions, poor, caving	W. G. Weber.
0.8	Granite			Key or Star	Conditions, fair	W. G. Weber.
0.7	Schist, granite			Key or Star	Conditions, poor, wet caving	W. G. Weber.
0.4	Schist, granite			Key or Star	Conditions, poor, caving	W. G. Weber.
0.5-1	Hard limestone	5%	18		Blast holes	E. & C., 1/23/07.

* Size of core.
† Ft. per hr. actual drilling time.

variable. Mr. W. T. Kersher states that in shales, limestone, and conglomerate rock, lying at an angle of 30°, a 5-in. cable drill was tested with a 3-in. rod drill. The 5-in. machine was of the traction type and was therefore able to move from hole to hole in less time than the 3-in. drill. In the entire test, however, the 3-in. drill made much better progress as regards the number of holes drilled, which would prove the smaller bit and rod tools much faster in blast hole drilling. The best day's work of the rod machine was 73 ft. in 10 hr., and of the cable machine 71 ft. in 12 hr. It is interesting to compare with this the speed obtained with various size bits in deep hole work. (Page 285.)

Advantages of Cable or Well Drills in Blast Hole Drilling.

The advantages of the well drill as compared with the tripod drill are many:

(1) A drill will not stick in the hole, because of the powerful direct pull of the rope that operates the drill rods.

(2) There is no limit to the depth of the hole, and the deeper it is (up to any limits possible in blasting), the better a cable drill works, due to the increased weight of rods.

(3) The drills will drill through the earth overlying the rocks, so no stripping is necessary.

(4) The holes, even in work on high breasts, are drilled the full depth of the breast, making benches unnecessary.

(5) The large holes permit the use of larger charges of explosive and of wider spacing of holes.

(6) Blasting is less frequent, due to the wider spacing of holes.

(7) The fact that the hole is the same size at the bottom as at the top permits the placing of the charge close to the bottom of the hole where it often does the most good.

(8) Such a large amount of rock can be shot at one time that it is possible to keep a large supply ahead of the loading gang, thus avoiding delays.

(9) This type of drill consumes less fuel, as a rule, than the ordinary percussive tripod drill.

(10) The weight of bits to be carried back and forth from the blacksmith shop is much less than for ordinary percussive drills.

A study of the speed of drilling given in Table XXXIII indicates quite clearly one of the limitations of the cable well drill for blast hole drilling.

In most granites, schists, traps and other rocks of igneous origin, the footage drilled per hour is usually so small as to give the cable or well drill no advantage over the ordinary percussive tripod drill even where deep cuts are to be made. In shallow cuts of course the relatively light percussive tripod drill is more *economic*.

Cost of Operating Cable Drills. The engine power and weights of cable drills are given in Table XXXII. The prices of drills are given on page 256. Let us take for illustration an 11 ton, 14 hp. machine whose price is \$1,600. Assuming that the drill will average 150 days worked per year, we may estimate the daily (10 hr.) cost as follows:

	Per day.
Drill runner	\$ 4.00
Drill helper and fireman	3.00
Coal, 1,000 lb. (or 0.8 cord wood)	3.00
Oil and waste25
Water, 1,000 gal. (8,300 lb.)	1.50
Wear of manila cable (2-in.), 4 ft. at 25ct.	1.00
Repairs to machine and tools	1.50
Depreciation, 12% of \$1,600 ÷ 150 days worked ..	1.30
Interest and taxes, 8% of \$1,600 ÷ 150 days85
Blacksmith, 0.2 day at \$4.0080
Blacksmith coal, 10 lb.10
Foreman, 0.2 day at \$6.00	1.20
Total	\$18.50

This \$18.50 does not include the following items: (1) Installing and removing the plant; (2) building roads; (3) casing, if there is earth overlying the rock; (4) general superintendence and office expense.

The costs of coal and water, as above given, are high enough to include hauling where the haul is short; but for long hauls it will be necessary to calculate these items carefully. Steam engines consume about 7 lb. coal per hp. hr., and each pound of coal evaporates about 7 lb. of water, so that, including wash water for the drill hole, about 1 gal. (8.3 lb.) of water per lb. of coal is required.

In the above example it is assumed that one blacksmith serves 5 drills. If there are fewer than 3 drills, it is customary for the drill runner to sharpen his own bits.

If wood is used for fuel, about 0.8 cord will be required for the 14 hp. engine. If a gasoline engine of 14 hp. is used, estimate 1 pt. of gasoline per hp. hr. of actual running of the engine; and since the engine is running only about 6 hr. out of the 10 hr. shift, a 14 hp. engine will consume about 10 gal. of gasoline.

Table XXXIII gives the footage drilled per hour (8 to 12 hr. per shift) per cable drill, under different conditions.

Cost on Pennsylvania Railroad Work. In *Engineering News*, Sept. 24, 1903, I described the use of well drills for blast hole work. The well drillers were the ordinary type of portable cable driller, consisting of a wagon on which is mounted a 4 to 8 hp. engine that drives a walking beam; the walking beam raises and lowers a rope, to which is fastened the churn bit and rods that form the "business end" of the driller. A 5½-in. bit was used in this work, and even with this large bit each drill averaged

three 20-ft. holes, or 60 ft., drilled in shale per 10-hr. shift. In limestone, however, and in hard sandstone not more than 10 ft. of hole were drilled per shift.

Mr. W. R. Hulbert gives (*Engineering News*, Apr. 12, 1906) the following cost of cable drilling work on the Pennsylvania low-grade freight line, which comprised double track work high above the Susquehanna River between Columbia and Sag Harbor and involved the making of large side-hill cuts.

The rock was a hard gneiss and mica-schist formation. The rock varied in hardness, and with the seams sloping at varying angles, caused the drills to deflect, adding to the difficulties of drilling. In crossing seams and to straighten holes, X bits were used.

For most of the work a central power plant generating compressed air drove the machines, but for the first 60 days the drills were steam driven and the cost of temporary boilers, etc., was higher than with the central plant. Roads 10 ft. wide were first constructed by hand labor, but in some cases, percussive drills, drilling 10 to 30 ft. deep were used. Over these roads the well drills were operated.

The method used with the cable drills was to drill a number of very deep vertical holes along the inside of the cut, and with the percussive tripod drill, a series of "snake" or "toe" holes on a level with the bottom of the vertical holes. These were sprung with dynamite, and then loaded with blasting powder and the entire series discharged at one time by an electric current. Enormous charges were used, dislodging great quantities of rock.

The first 10 to 40 ft. of some cable drill holes was cased. The holes were 5½ in. in diameter and ranged from 100 to 130 ft. deep. The average drilling was 19½ ft. per 10-hr. shift, but varied from less than 9 ft. to 60 ft. The economy of this method resulted from the fact that more rock was displaced in blasting, and that the steam shovels were able to work at loading directly on grade instead of in several cuts. The cable drill machines worked as well with air as with steam, but required not less than 80 lb. pressure. The percussive drills drove holes 4½ in. to 1½ in. in diameter, averaging 40 to 60 ft. per day.

Comparative Speeds in the Enola Yards of the Pennsylvania R. R. Co. In shale rock in which percussive tripod drills stuck repeatedly, 300 to 400 laborers were employed at drilling holes 20 to 30 ft. deep with hand churn drills. Ten steam shovels were used to load the material, and, as the contractors desired to increase the output without increasing the large labor expense, Star cable well drills were placed on the work. The cuts averaged 75 ft. high. Although in hand drill work it was necessary

to remove the rock in three lifts or benches, the cable drills accomplished it in one lift. Seventeen cable drills, of a capacity of 250 to 400 ft. of $4\frac{1}{2}$ to 6-in. hole, fitted with 5 to 6-hp. reversing engines, kept 22 steam shovels supplied with material. The drills were steam driven and made from 20 to 80 ft., averaging 48 ft. of hole in 10 hr.

Comparison of Cost of Cable and Tripod Percussive Drilling.

Mr. W. M. Douglass, of Douglass Bros., contractors, was kind enough to keep records for me showing the cost of operating a Cyclone cable drill compared with a Rand percussive drill. The following are the data:

The holes were drilled with bits to give 3 in. diam. at the bottom of the holes. Holes were 24 ft. deep in solid brown sandstone in eastern Ohio. In 14 days, of 10 hr. each, the driller put down 692 ft., or practically 50 ft. per day. The daily cost of operating the Cyclone was as follows:

Drill runner	\$3.00
Drill helper and fireman	2.00
Pumping water60
6 bu. (480 lb.) coal at 10 ct.60
Total for 50 ft. of hole	\$6.20

This gives a cost of $12\frac{1}{2}$ ct. per ft. of hole, not including rope wear, interest, repairs, depreciation and bit sharpening. The best day's work in the brown sandstone, using all the weights, was 53 ft., but in blue sandstone, which was softer, 60 ft. were drilled per day using light weights.

In the same brown sandstone cut an 8-day test was made with a $3\frac{1}{4}$ -in. Rand percussive drill for comparison. The holes were 20 ft. deep, $1\frac{3}{4}$ in. diam. at the bottom (as against 3 in. with the cable driller), and 28 holes were drilled in the 8 days, making 70 ft. the average day's work. A 10 hp. boiler furnished steam. The daily cost of operating the Rand drill was:

Drill runner	\$3.00
Drill helper	1.50
Fireman	2.00
Water75
10 bu. (800 lb.) coal at 10 ct.	1.00
Total for 70 ft. of hole	\$8.25

This was equivalent to 11.8 ct. per ft. of hole, not including rope wear, interest, repairs, depreciation and drill sharpening.

It should be observed that the cable drill holes were deeper (and they could have been still deeper without increasing the cost per foot) as well as larger in diameter than the percussive drill holes. The greater diameter saved a considerable amount of dynamite in springing the holes, since each cable drill hole was sprung three times, as compared with four or five times for the percussive drill holes, in order to make a chamber large enough to hold the black powder. Mr. Douglass has made some interesting tests on the use of black powder and dynamite in alternate rows of holes, for which see page 472.

Cost of Cable Drilling in Quarry Work in Ohio. In *Engineering and Contracting*, Aug. 3, 1913, the Lewisburg Stone Co., of Lewisburg, Ohio, gives the following record of 43 consecutive days' work of a cable drilling machine in drilling blast holes in a quarry. The rock was medium hard but full of seams for the top 10 ft. Below this was 5 ft. of hard cap rock followed by very hard blue limestone. The machine used was a No. 2-G Clipper built by the Loomis Machine Company of Tiffin, Ohio, operated by a 10-hp. gasoline engine. The holes ranged in depth from 22 to 30 ft. and were 5 in. in diameter. The cost of operation per 10-hr. day was as follows:

1 drill runner at \$2	\$2.00
1 helper at \$1.75	1.75
Gasoline	1.00
Oil10
Total	<u>\$4.85</u>

This does not include repairs, rope wear, water and fixed charges.

In a run of 43 days of 10 hr., the drilling ranged from 25 to 71 ft. per day, the average being 46.8 ft., at a cost of 10.4 ct. per ft. for labor, gasoline and oil.

Rate of Drilling in Basaltic Rocks. In *Engineering and Contracting*, May 20, 1908, the following data are given: In drilling holes for blasting at Ellensburg, Washington, on a line built by the Chicago, Milwaukee and St. Paul R. R., a 3-in. Cyclone rod drill (or well drill) was used by the contractors. The material was hard basaltic rock, full of seams and crevices, making difficult drilling.

A careful record of the work of the machine was kept for the month of March, 1908. The machine, operated by 2 men, a driller and a helper, drilled 1,353 ft. of hole. The total number of hours worked was 259. This gives a record of 52 ft. per 10-hr. day.

This time included moving the machine from one hole to another, and all delays during working hours incidental to work of this character. The average depth of the holes was 23 ft., so to do this amount of work 2 set ups were made on an average a day, there being 59 holes drilled and work was done on 27 different days.

Record of Drilling in a Limestone Quarry. In *Engineering and Contracting*, June 1 and 15, 1910, the following data are given: In the large quarry of the Doles & Shepard Co., of Chicago, well drilling machines have been substituted for tripod drills and have proved a decided economy. The power on the 6 electrical well drills costs from \$1.80 to \$2.00 per 10-hr. day, and on the tripod air drills it cost \$5 to \$5.20 per 10-hr. day. Only one-third as many large holes are required as were small holes. The large holes are 5½ in. in diameter and 40 to 45 ft. deep. In a 30 day run, each drill averaged 34 ft. per 10-hr., the best drill averaging 51 ft. and the poorest drill 21 ft. per day. Two men operated each drill. Cables were renewed every 30 days. It required 3 hr. to change a cable.

The holes are made in one row from 18 to 22 ft. back from the ledge and are spaced from 8 to 12 ft., an average of 10 ft., apart. When tripod drills were used the holes were in two rows, the second being not more than 18 ft. from the edge, and the holes were 8 ft. apart.

Cost of Cable Drilling in Mining Copper Ore. An article in *Engineering and Contracting*, Sept. 9, 1908, on open pit mining with a steam shovel in Nevada, gives the following cost of cable drilling. The ore lies in a flat and is estimated to be not more than 200 ft. in depth, the ore occurring in a porphyry. It is capped with earth and rock to a depth of about 87 ft. The stripping and ore are worked in trenches 50 ft. deep. The holes are put down by two Keystone No. 5 traction drills (see Table XXXII) owned by the mining company and kept continually at work drilling to loosen ground for the steam shovels. The Keystone No. 5 machine is built specially for mineral prospecting and mine work, it being the next to the largest machine made by the Keystone Driller Co. The boiler is mounted on the same trucks with the engine, and the machine is propelled on traction wheels. The engine is 14 hp. The derrick is 34 ft. high. The machine weighs 16,000 lb. and costs, without tools or equipment, \$1,375. *This machine will drill holes from 1,000 to 1,200 ft. deep.*

CABLE DRILLS, AUGERS AND COST DATA 271

The drills use a 5/8-in. bit which gives a hole about 6½ in. in diameter, and the holes are put down to a depth of about 60 ft. The holes are spaced on 35-ft. centers and are back from the breast of the bench 40 ft. This is the usual spacing. However, where hard masses of tough carbonate ores are encountered, holes are about 15 ft. apart and 15 ft. from the breast. Each machine requires a driller, and an assistant. Nine-hour shifts are worked. A 60-ft. hole is put down in two shifts, or 18 hr., thus 3 ft. 5 in. of hole is drilled per hr.

The cost of drilling is as follows:

	Per day.	Per ft.
Driller	\$ 4.00	\$.13
Assistant	3.00	.10
Fuel, .83 cords at \$6	5.00	.17
Oil and waste28	.01
Extra parts, repairs and renewals	1.07	.04
Rope wear	1.75	.05
Estimated interest and depreciation	1.00	.03
Total for 30 ft.	\$16.10	\$.53

The cost of blasting on this work is given in Chapter XI, pages 492 and 498.

Cost of Cable Drilling in Westchester Co., N. Y. I am indebted for the following data to an article in *Engineering Record*, Jan. 21, 1911:

Drills: 2 steam and 2 gasoline driven cable well drills.

Bits: 5/8 in.

Depth of Cut: Up to 55 ft. Holes drilled 2 ft. below grade.

Minimum economical depth of cut for drills was 15 ft.

Spacing of holes: 12 ft. apart across cut and 18 ft. apart longitudinally.

Holes sprung with 2 to 4 sticks of dynamite.

Holes blasted with 60% Forcite; in a 50-ft. hole 200 lb. were used.

Rate of drilling: Average in shale, 44 ft. in 10 hr.; average in limestone and gneiss, 26 ft. in 10 hr.

Cost of drilling: 20 ct. per ft. in shale; 34 ct. in limestone and gneiss.

Operating cost of drill per 10-hr. day:

	Steam.	Gasoline.
1 Operator	\$4.00	\$4.00
1 Helper	2.00	2.00
Blacksmith at \$.25 per hr.50	.50
Fuel	1.00	1.20
Lubricant25	.35
Rope50	.50
Interest at 5 per cent. on \$1,100 and depreciation 10%47	.47
Total	\$8.72	\$9.02

Uses of Well Drilling Machines. Well drilling machines are primarily designed and generally used for boring water and oil

or gas wells, but they are also frequently used in making test wells and prospecting for minerals, in making soundings for bridge piers, lock locations, etc., in driving sewer and drainage wells on flat lands, in drilling plunger holes for hydraulic elevators, and in blast hole drilling for rock excavation. While all the uses of well drilling machines are of interest to the student of rock excavation, a knowledge of the drilling of blast holes is particularly important.

To a railroad contractor belongs the credit of first using well-drillers for blasting purposes, and in *Engineering News*, Sept. 24, 1903, I first described the use of well drillers on Pennsylvania Railroad work. These machines were of the ordinary portable type having a 4 to 8-hp. engine which raised and lowered a string of tools attached to a cable. A 5 $\frac{1}{8}$ -in. bit, the common well size, was used in that work. I suggested that if the bits were reduced to about 3-in. diameter and if the drill rods were suitably weighted, much better progress would be made. Shortly afterward the Cyclone Drilling Machine Co. put upon the market such a drill. The machine had a 5 hp. engine, used a 3-in. bit, had drill rods that screwed together and a suitable weight to give power to the blow.

A 3-in. hole can be more rapidly driven than a larger hole, but it should be remembered, however, that it will often pay, especially in very deep holes on high quarry faces, to drill a larger hole, thus permitting the placing of all the charge near the bottom of the hole. On the other hand, small holes have been found to spring much better than large holes out of which the tamping is often blown.

The Value of Drill Holes in Prospecting. To be of value in prospecting, extreme care must be taken in locating the drill-hole and in obtaining and recording the samples. Much depends upon the operator of the machine, for even an experienced engineer can be deceived by the operator as to the character and kind of materials encountered. In wash-borings, especially when powerful pumps are used, the light, fine material is washed away and the impression is produced that the material is coarse; clay or silt appears to be sand, and sand appears to be gravel. To avoid this, dry samples should be taken in clay, mud, etc., and the discharge pipe should be covered with bagging in order to catch the fine material. Some churn drills have an arrangement for fastening a hollow tube (see Fig. 54) armed with a toothed cutting bit, a core barrel, and a weighted bar. This, by percussion, enters into the material and the core is gripped by a split ring when the barrel is withdrawn. The well drill is not well adapted for prospect work in hard material.

Cost of Cable Drilling in Prospecting. Mr. Robert Marsh



Fig. 54. Churn Drill with Hollow Tube.

gives the following costs of cable drilling and shaft sinking in the copper ores of the Ely District:

The cost of drilling ranges from about \$1 per ft. in very favorable ground to \$2 in ground of difficult character, with an average of about \$1.50 in fair ground. The rate of advance will average from 20 to 25 ft. per day in fair ground. A few typical examples may be of interest:

Hole No. 1. Time, 11 days; footage, 235 ft.; cost per ft., \$1.30; conditions favorable.

Hole No. 2. Time, 16 days; depth, 412 ft.; cost per ft., \$1.86; good hole, standing well.

Hole No. 3. Time, 14 days; depth, 230 ft.; cost per ft., \$2.33. Trouble with crevices and fitchering.

The above costs include: Labor, superintendence, tool-sharpening, oil, hauling water 2 to 3 miles, wood fuel costing about \$6 per cord, maintenance, repairs and casing where necessary. There were worked two 12-hr. shifts per day, the drillers receiving \$6 per shift and the helpers \$4.05. Moving the drill is not included. Water and wood were expensive items.

Mr. William R. Wade in *The Mining World* (1908) gives the following comparison of costs of prospect drilling and shaft sinking in exploring turquoise mining property in New Mexico. A good shaft of two compartments, 300 ft. deep, costs about \$15,000 and 1,000 ft. of drifting and cross-cutting around this shaft would bring the expense close to \$30,000. If this shaft had a cross-cut from its bottom 500 ft. each way it would develop 1,000 lin. ft. of ground. On the other hand, a row of drill holes placed 150 ft. apart, each 300 ft. deep, will develop the same ground. Churn drilling with a No. 4 Cyclone combination drill costs about 50 ct. per foot, including labor, interest, supplies and repairs, but not including office expenses, superintendence, assaying, etc. Allowing \$1 per ft. for drilling, the cost of sinking the holes would be \$2,100, and when the cost of the machine completely equipped for core taking, etc., on the ground, \$2,200, is added, the cost of prospecting with drills is only \$4,300 as against the cost of prospecting by a shaft of \$30,000.

Of course, it can be said if the shifts and crosscuts hit ore, they are afterwards of use, while the drill hole is not. Suppose the ore is encountered 800 ft. from the shaft, then we have \$15,000 for shaft and \$12,000 for cross-cutting. With the ground drilled first the shaft could be placed near the ore in the foot wall, and

we have \$15,000 for shaft, \$1,000 for short cross-cuts and station and \$4,200 for drilling, or a total of \$20,200, making a saving of nearly \$10,000. It must be remembered that when two or three levels are developed, with the shaft a long way from the ore, the expense is much heavier, and this is generally necessary to lay out a mine.

Mr. A. H. Field (*Engineering and Mining Journal*, Oct. 22, 1910) gives the following facts about prospecting with cable drills in the Miami district, Arizona. Star drills (traction, 1,000-ft. machines, see Table XXXII) were used. Holes were drilled to 400 to 600 ft. in decomposed granite and soft schist, containing hard streaks and subject to caving. A 10-in. bit was used to start the hole; bits next in order were 7½, 6¼ and 4½ in. The country is mountainous, necessitating much road building for the drills. Ten holes were drilled at an average speed of 21.1 ft. per 12-hr. day shift. Night shifts were not run, as a day crew accomplished 50% more than a night crew. It took about 8 hr. to dismantle, move from one hole to the next, and set up machine. Thereafter the first 250 ft. of hole was drilled at the rate of about 25 ft. per shift. The speed gradually falls until the first string of casing is lowered at about 250 ft., when the time consumed in placing the casing (5 hr.) cuts down that day's progress. Successive strings of casing are lowered after about every 100 ft. of drilling.

The distribution of the average 279 hr. spent on each hole was as follows:

	Per cent.
Drilling and sampling	72.09
Lowering casing	3.21
Removing casing	2.45
Repairing	2.79
Delays	13.65
Moving	5.81
Total	100.00

All the lost time, except in moving, increases with increased depth of hole. *There is very little difference in the speed of drilling the upper part of a hole with a 10-in. bit and the lower part with a 6¼-in. bit.*

This paradox, excepting delays due to depth as mentioned above, may be accounted for by the following reasons: As smaller casing is introduced, the same-sized rope and tools (2-in. manila cable and 4-in. auger stem) are continued in use. These, dragging against the sides, and in the smallest casing forming an air cushion, tend to lower the speed. Moreover, ground water is encountered in all the holes at depths of from 150 to 250 ft. *Once the tools strike permanent water, and it must be borne in mind that casing seldom keeps out this underground flow,*

the speed diminishes. Figures are not available to give the percentage decrease in speed. The relatively high speed of spudding is another determining factor in raising the average speed of the largest-sized bit.

Drill crew consisted of two men paid \$6 and \$4.80, respectively, for 12 hr. An extra man for two or more machines is desirable, for he will assist in moving, in casing work, and in repairing.

Cost of Prospect Drilling in Nevada and Missouri. In *Engineering and Contracting*, July 3, 1907, the following data are given: Mr. C. E. Hart, of Joplin, Mo., who has had extensive experience in prospecting with well drills both in the lead and zinc mining districts of Missouri and those of the Ely district in Nevada, gives the following:

Cost of Operation. The cost of well drilling work for prospecting varies widely. Some drilling done at Ely, Nevada, in 1907 in rhyolite reached a record of 54 ft. in 8 hr., or 6¾ ft. an hour. In porphyry, however, a good day's work was 1 ft. per hr., including all stops. In the Nevada work the wages per 8 hr. shift were as follows:

Drillmen	\$ 4.00
Helpers	3.25
Teamster and two-horse team	6.50
Teamster and four-horse team	10.50

In the Missouri lead and zinc field the wages are about one-third less.

The contract price in Missouri for holes down to 200 ft. is from \$0.90 to \$1 per ft., and a greater rate for deeper holes. Drilling costs in this district about \$0.65 per ft. on an average. It was found in drilling some 6,000 ft. in Nevada that the costs averaged close to \$3 per ft. A large part of the difference was for wood for fuel and in the cost of teaming; in fact the cost of hauling wood and water to the machines was nearly one-fourth the total cost. Wood cost at the drill \$6 per cord and water cost 1 ct. per gallon. Blacksmith's coal and oil also cost more. As showing the two extremes of cost per foot the following detail costs of two holes are given from actual records:

Hole Drilled Through Lime and Flint in Missouri (hole 200 ft.)

	Total	Per ft.
2 drillmen at \$3 per 10 hr.; 2 helpers at \$2.25 per 10 hr.....	\$144.00	\$.720
Fuel, coal	6.50	.033
Blacksmith's coal	1.00	.005
Oil, cylinder and engine	1.10	.005
Repairs and depreciation	7.40	.037
Total	\$160.00	\$.800

The contract price was \$1 per ft.

*Hole Drilled Through Rhyolite and Soft Lime in Nevada •
(hole 280 ft.)*

	Total.	Per ft.
3 drillmen at \$4 per 8 hr.; 3 helpers at \$3.25 per 8 hr.	\$503.00	\$1.796
Superintendence	162.10	.587
Fuel, coal	147.00	.525
Blacksmith's coal	9.10	.033
Oil, cylinder and engine	5.25	.019
Water	132.00	.471
Repairs and depreciation	23.12	.083
Total	\$981.57	\$3.514

As showing the effect of weather and formation on the cost of drilling two examples of work in the Nevada fields are given. In the first case the work was done in September with all the weather conditions in its favor and the drilling was through rhyolite, which is an almost ideal formation for this kind of drilling, it drilling easily and being homogeneous enough to retain its shape without caving. In the second case the work was done in February, drilling through porphyry. The weather conditions were unfavorable and the porphyry was too soft to stand up under the rush of the water and caved badly. The cost of drilling in the two cases was as follows:

Drilling Hole 308 ft. Deep in Rhyolite

	Total.	Per ft.
1 drillman, six 10-hr. days at \$125 per mo.	\$ 24.18	\$.078
1 helper, six 10-hr. days at \$100 per mo.	19.32	.063
1 drillman, 17 8-hr. days at \$125 per mo.	68.51	.222
1 helper, 17 8-hr. days at \$100 per mo.	25.76	.084
1 helper, 17 8-hr. days at \$120 per mo.	36.00	.117
$\frac{3}{4}$ cord wood per shift at \$4.50 per cord	77.51	.251
8 bbls. water per shift at \$6.50 per day	100.75	.327
2 gallons oil per day	2.20	.007
Blacksmith's coal, 200 lb. at \$54 per ton	5.40	.017
Miscellaneous charges	162.65	.528
Total for 308 ft. hole	\$522.28	\$1.694

Drilling Hole 160 ft. Deep in Porphyry

	Total.	Per ft.
3 drillmen at \$4 per shift	\$107.50	\$.672
3 helpers at \$3.25 per shift	108.80	.679
Superintendence	86.40	.540
Blacksmith's coal	8.80	.055
Oil, engine and cylinder	3.18	.019
Water	72.10	.451
Wood	72.10	.451
Maintenance and depreciation	14.33	.089
Total for 160-ft. hole	\$473.21	\$2.956

In the case of the second hole in porphyry six days' time were lost while waiting for casing. The rock caved badly, preventing the gaining of greater depth. More than one-third of the total time was taken up in casing the hole.

Cost of Prospect Drilling in Montana.* The following is a record of some holes drilled at Mussellshell and Roundup, Montana, for the Republic Coal Co. of Chicago, Ill.

The work was done with a No. 2 Cyclone drill (see Table XXXII). The machine was equipped with hollow rod tools. This machine is designed to drill holes from 500 to 700 ft. deep; it is equipped with a 7-hp. gasoline engine. Holes from 23 ft. to 517 ft. were drilled. The bits used were 2½ in. Two men, the drill runner and a helper, were employed on the machine. The work was done in prospecting. The record of each hole is given in the table.

Hole No.	Depth, ft.	Ft. drilled per shift.	Material.
1	391	39	Shale and sandstone.
2	293	37	Shale and sandstone.
3	284	47	Shale and sandstone.
4	347	50	Shale and sandstone.
5	103	51	Shale and sandstone.
6	297	42	Shale and sandstone.
7	36	52	Soil and gravel.
8	24	32	Soil, gravel, shale.
9	52	47	Soil, gravel, shale.
10	27	33	Soil, gravel, shale.
11	53	30	Soil, gravel, shale.
12	517	37	Shale and sandstone.
13	463	57	Shale and sandstone.
Total	2885	42	

In all, 69 days were worked, making the average nearly 42 ft. drilled per 10 hr. shift. A two horse team was used to haul water and other supplies. The machine used 4 gal. of gasoline per day. It will be noticed that the cost of the team was nearly 50% of the total cost.

Drill runner, 69 days at \$2.50	\$172.50
Helper, 69 days at \$2.00	138.00
Team, 69 days at \$4.00	276.00
276 gal. gasoline at 12 ct.	33.12

Total \$619.62

This gives a cost of 21½ ct. per ft. of hole. To this should be added an allowance for plant and superintendence. It will be noticed that some of the holes are very shallow, thus necessitating frequent moves of the machine.

Costs of Prospect Drilling in New Mexico and Arizona. The costs of prospect work in exploring the copper ore deposits of New Mexico and Arizona are given by Mr. Fred B. Ely in the *Harvard Engineering Journal* (1912). The machines used were the Cyclone, Keystone and Star. Holes were first drilled at random and finally spaced 100 to 200 ft. apart. Samples of the

* *Engineering and Contracting*, Nov. 18, 1908.

sludge were taken from each 3 or 5 ft. of hole. Two shifts of 12 hr. each were customarily worked. The driller was paid \$6 per shift and the helper \$4.50. In very rough country the cost of road making required for moving drills will average 10 to 20 ct. per ft. of hole.

The cost of a typical month's work was as follows per ft. of hole:

Labor	\$.90
Fireman03
Coal13
Supplies20
Sampling18
Assaying10
Teaming13
Equipment24
Administration10
Water07
Total	\$2.08

Costs and Records of Prospecting, Silverbell, Arizona. In prospecting for copper ore, a No. 23 Star traction drill (see Table XXXII) was used, and the following data are obtained from an article by Mr. M. B. Gentry in *Mines and Minerals* (1910). Two 12-hr. shifts were worked and the wages of driller were \$6; of helper \$4.50; and of sampler \$3, per shift. The sizes of bits used were 7/8, 6¼, and 4¼ in. The first 100 to 130 ft. of hole were "spudded."

Number of holes drilled	62
Total feet drilled	14,256
Total drill days	579
Average depth of holes, feet	229.9
Average footage per drill per day	24.6
Number of drill months	19.3
Average footage per drill per month	738
Average footage per foot of cable	1.82
Average footage per ton of coal	22.97
Average tonnage of coal per day	1.07
Gallons of water used per day	2,200
	Hours.
Moving (7.6 per cent.)	1,058
Drilling (65.2 per cent.)	9,071
Repairs (8.2 per cent.)	1,147
Fishing (2.9 per cent.)	393
Casing (1.4 per cent.)	186
Idle (14.7 per cent.) except in repairs	2,041
Total hours	13,806

One-half the water was used for boiler, one-half for hole and sampling. The average cost per ft. was:

Labor on drills	\$1.25
Supplies17
Pipe line09
Repairs07
Fuel35
Renewals12
Roads47
Total per ft	\$2.52
Average cost of cable per foot of hole	\$.132

The cost of roads was high on account of rough country.

Cost of Drilling with Well Drilling Machines in Ore Prospecting, Ludlow, California. The data following are from two records of well drilling or churn drilling in prospecting for ore. While wages and prices are unusual, the data are so given that they can be used generally by substituting other figures. Both records are from the *Engineering and Mining Journal* but the data have been considerably rearranged.

Pacific Mines Corporation. The figures here presented were compiled by C. H. Palmer, Jr., from drilling operations at the property of the Pacific Mines Corporation, seven miles south of Ludlow, Cal.

Twenty-four holes having an average depth of 258 ft. were drilled within a radius of 1,100 ft. to prospect the extension of the present orebodies, which dip gently to the north. A Star rig No. 23 was used, and holes were drilled with an 8¼-in. bit and 2½-in. manila drill cable. When casing was required the hole was continued with a 6-in. bit. The work was done by two drilling crews, each consisting of a driller and a helper. On days when it was necessary to move the rig, both crews assisted. The driller received \$6 a day and his helper \$4.80.

An average of the formation passed through consisted of:

Wash formation, ft.	21
Trachyte porphyry, ft.	210
Kaolinized hanging wall, ft.	4
Ore zone, ft.	18
Quartz-monzonite foot wall, ft.	5
Total	258

No difficulty was encountered in drilling these formations, although the hanging-wall material was sticky and the hard-ore zone necessitated sharpening the bit about every 5 ft.

The topography is not rough within the radius drilled. The weather is hot in summer and the country arid, the water-supply being obtained at Ludlow for \$1.50 per 1,000 gal. Coal costs \$8.15 per ton delivered at the mine.

These holes required 45 lb. of coal and 21.6 gal. of water per foot drilled. The costs do not include those for moving the rig for drill-hole set-ups, which amounted to \$215 for coal and water and \$263 for labor. The accompanying table gives the distribution of time in the drilling operations:

Total possible drilling hours — 3,092.		
	Hr.	%
Actual drilling	2,626	84.93
Casing	59	1.91
Removing casing	34	1.10
Repairing drilling machine and rope	141	4.56
Fishing for tools	19	0.61
Unforeseen delays	213	6.80
Total	3,092	100.00
<i>(Moving the rig for set-ups took in all 527 hr.)</i>		

The cost of drilling the 24 holes was divided as follows:

Item.	Per ft.
Fuel, coal	\$.183
Oil and grease007
Firebrick007
Labor598
Cable111
Water054
Coke016
Repair parts and tools042
Unclassified025
Totals	\$1.043

Wells Nos. 1 and 2, total footage drilled 811, having an average depth of 405 ft., were drilled for a water-supply for milling and domestic purposes, and were located about 5.5 miles east of the mine. The formation passed through consisted of wash, fine sand and clays. The costs and time distribution were as shown:

Total possible drilling hours — 703.

	Hr.	%
Actual drilling	444	63.16
Casing	78	11.10
Repairing drilling machine and rope	81	11.52
Fishing for tools	58	8.25
Unforeseen delays	42	5.97
Totals	703	100.00

(Moving the rig for set-ups took in all 149 hr.)

These holes required 61 lb. of coal and 22.5 gal. of water per foot drilled. Moving the rig for drill-hole set-ups cost \$51 for coal and water and \$192 for labor in addition to the above figures.

The higher per-foot cost, in comparison with holes Nos. 1-24, was due to the necessity of casing both the wells, while the distance from supplies and shops added to the cost in the form of teaming and repairs, respectively.

The cost of drilling wells 1 and 2 was divided as follows:

Item.	Per ft.
Fuel, coal	\$.250
Oil and grease013
Teaming505
Labor952
Cable194
Water057
Coke016
Repair parts and tools084
Unclassified022
Total	\$2.093

Well No. 3, total footage drilled 572, was drilled on the southern edge of a dry lake 7.8 miles north of Ludlow, Cal., and a short distance west of the Tonopah & Tidewater R. R. Drilling was carried on under difficult conditions. The excessive heat, accompanied by high winds, partly accounts for the high labor charges noted below. One drilling crew was used. Eight-inch

pipe was used to case the hole, which was necessitated by caving, caused by the encountering of salt water flows in the dark clays.

The material drilled consisted of:

Wash formation, ft.	70
Yellow clay, ft.	180
Dark, sticky clays, ft.	322
Total	572

The sticky clays made the progress slow and added to the water costs. Boulders also caused troubles and delays. Water was delivered to a point near the well by the T. & T. R. R. for \$2.50 per 1,000 gal. This hole required 100 lb. of coal and 61 gal. of water per foot drilled, the latter including the water used for the domestic purposes of two drillers for 95 days. The pipe was not recovered.

The cost of drilling well No. 3 was divided as follows:

Item.	Per ft.
Fuel, coal	\$.407
Oil and grease005
Firebrick011
Labor	1.998
Cable386
Water174
Coke023
Repair parts and tools065
Teaming294
Pipe	1.030
Unclassified002
Totals	\$4.895

While the preceding costs seem high, Mr. Palmer reports that they may be taken as a fair average by those contemplating drilling similar footages under the trying conditions of an arid country. Sand storms greatly hindered work on well No. 3 and excessive heat at night made sleep difficult. This decreased the efficiency of the drillers and is partly responsible for the high labor charges. An unavoidable loss of time resulted from these circumstances which had a corresponding effect of increasing the water and fuel costs. Wells Nos. 1 and 2 were drilled under more suitable conditions than well No. 3, although far from satisfactory for efficient labor returns. As all drill and domestic supplies had to be carried a distance of 5.5 miles over heavy roads, teaming charges were high. Conditions were more satisfactory for low costs while drilling holes Nos. 1 to 24 inc. Repair shops were at hand and living conditions were excellent. Boulders encountered in the wash formation retarded, however, the work: also drilling the hard-ore zone and monzonite, and often portions of the trachyte was very slow, which especially increased the fuel and labor charges.

Miami Copper Co. Records of this Arizona mine for some five

years as given by H. P. Bowen include about 44,500 ft. of churn drilling, consisting of 73 holes of an average depth of 605 ft. In this work two No. 23 Star traction machines, equipped with No. 24 boilers and derricks, were used. All holes were started with a 10-in. bit and in a few cases it was necessary to use the 4¼-in. tools to reach the desired depth. Two-inch manila rope was used in starting and this was replaced by ¾-in. steel drilling cable when water was encountered, which occurred usually at from 300 to 400 ft. One-half of the holes were drilled at the corners of 200-ft. squares and the others on 400-ft. squares. The drilling was divided into two 18-month periods, in each of which a nearly equal footage was drilled and the following scales of wages paid:

	1st. period 12-hr. shift.	2nd period. 8-hr. shift.
Foreman, per mo.	\$200.00	\$200.00
Samplers, per mo.	100.00	100.00
Drillers, per shift	6.00	5.00
Helpers, per shift	4.80	4.00
	9-hr. shift.	8-hr. shift.
Laborers, per shift	\$2.00	\$2.15
Machinists, per shift	4.25	4.25
Carpenters, per shift	4.25	4.25
Blacksmiths, per shift	4.25	4.25

After the completion of the second drilling period, all tools, casing and repair parts were collected, repaired and stored. The drills were taken down and rebuilt on new frames, new parts being used where necessary, new tubes were placed in the boilers and the engines lined up. The machines were then housed-in, giving practically two new machines. Besides ordinary running expenses, the accompanying statements include the original cost of the machines and the cost of rebuilding them, the cost of all repair parts, tools, and casing charged out to churn drilling, whether actually used or not, the cost of two buildings, one for churn-drill supplies and the other in which the drills were stored. No credit has been allowed for the value of the rebuilt machines nor for the still serviceable tools, casing and supplies. The drilling cost of the two periods differed but slightly, the most noticeable variance being in the cost of repair parts which changed from 1 ct. per ft. for the first period to over 5 ct. per ft. for the second.

TABLE XXXIV. COST OF ORE PROSPECTING
REBUILDING AND REPAIRING.

Foreman	\$ 157.58
Drillers and helpers	498.50
Tinners and plate shop	53.81
Blacksmiths	34.78
Machinists	145.00
Carpenters	83.62
Miscellaneous labor	41.65
Teaming	199.96

CABLE DRILLS, AUGERS AND COST DATA

283

Repair parts	\$ 415.20
Iron and steel	6.72
Bolts, nuts, washers, and rivets	8.46
Coal oil and gasoline	17.75
Small tools	3.07
Packing and waste	14.27
Miscellaneous supplies	9.77
Total	\$1,680.14

COSTS OF DRILLING.

	Per ft.
Churn drills	\$.849
Churn drill tools2037
Wire drilling cable0336
Sand line0080
Manilla rope0598
Belting0045
Casing and drive shoes0872
Repair parts0316
Coal and coke	2.835
Lubricating oil and grease0094
Iron and steel0049
Galvanized and corrugated iron0064
Bolts, nuts, washers, and rivets0010
Timber and lumber0136
Coal oil and gasoline0059
Small tools0019
Packing and waste0019
Miscellaneous0086
Pipe and fittings0015
Sample sacks0203
Sampler's supplies0051
Engineering supplies0037
Churn drill rods	4.382
Water supply expense0415
Foreman	1.289
Engineers and draftsmen0689
Samplers	1.505
Drillers and helpers6460
Tin and plate shop0131
Blacksmiths0130
Machinists0165
Carpenters0095
Miscellaneous labor0135
Grinding and assaying samples0394
Teaming	2.376
Total	\$2.6976
Supply warehouse0097
Churn drill storehouse0067
Casing racks0028
Rebuilding machines, etc.0379
Total	\$2.7547

BUILDING ROADS:

	Per ft. of hole drilled.
Explosives	\$.0321
Tools and drill steel0063
Miscellaneous supplies0017
Labor3981
Total roadwork	\$.4382

WATER SUPPLY:

	Per ft. of hole drilled.
Galvanized iron	\$.0032

Pipe and fittings	\$0.0256
Miscellaneous supplies0013
Labor0114
Total water supply	\$.0415

Mr. W. G. Weber (*Engineering and Contracting*, May 4, 1910) describes the method of drilling in the Miami district of Arizona. The rock encountered was granite and schist. Crews were composed of a driller and helper or tool-dresser working 12-hr. shifts. Holes were drilled with Keystone or Star machines to an average depth of 500 ft. The minimum amount of road required per hole was about 300 ft., and on the steep slopes (20 degrees) of this district, roads cost about 75 ct. per ft. of road. The life of a machine was estimated at 4 years and the cost of a machine with tools sufficient to operate that length of time would be about \$6,000. The cost of drilling varied from \$2 to \$3 per ft. and sometimes ran as high as \$5. The cost of camp maintenance and incidentals should be added to the following costs when drilling is the only means of development pursued.

Labor —	Cost per ft.
2 drillers at \$3.00 per day each	\$0.48
2 helpers at \$2.40 per day each	0.38
1 sampler at \$4 per day	0.16
1 foreman at \$6 per day (two machines).....	0.12
Total labor drill and sampling	1.14
Roads —	
Labor at \$2 per day	\$0.50
Foreman at \$4 per day	0.05
Powder, caps and fuse	0.03
Tools, etc.	0.01
Total road work	\$0.59
Coal, coke, oils, etc.	0.27
Water	0.10
Teaming	0.10
Assaying, office and incidentals, etc.	0.16
Interest and depreciation	0.20
Total cost per ft. of hole	\$2.56

Methods and Costs of Drilling 57 Prospect Holes with Well Drilling Machines. A very complete record of costs of operating two well drilling machines for drilling deep holes for prospecting mining property is presented by Mr. I. J. Stauber, Superintendent Savannah Copper Co., New Mexico, in the *Engineering and Mining Journal*, Sept. 14, 1912. An abstract of the article follows:

Owing to the shattered condition of the rock and the many nearly vertical, hard, slip planes, considerable trouble was experienced. The country rock is an altered monzonite porphyry, and except for slips, dikes, etc., is not very hard. Caving and crooked holes seem to be the most serious difficulty, although the previous unsatisfactory results were mostly due to inexperienced drillers.

The two Star 23-T (see Table XXXII) machines installed were

TABLE XXXV. TIME AND SPEED OF DRILLING WELL HOLES

Hole	Drilling	Time (hours)			Total	Depth of hole of per (ft.)	Depth of per water level (ft.)	Rock	Kind of drilling	Ft. per 24 hrs.
		Re-pairs	De-lays	Mov-ing						
1	72	11	12	41	136	103	Granite	Fair	18.2	
2	17	12	60	45	393	252	Granite and Schist	Poor (Caving)	19.9	
3		(Same as above + fishing.)			684	252	Schist	Poor (Caving)	8.8	
4					336	340	Granite and Schist	Fair	24.3	
5					456	421	Schist	Fair	22.1	
6	369	8	113	47	420	427	Granite and Schist	Fair	24.5	
7					580	468	Granite and Schist	Poor (Caving)	19.4	
8	487	5	120	52	468	505	Schist	Fair	25.9	
9	292	6	197	47	730	527	Schist and Granite	Poor (wet and caving)	17.3	
10	481	37	44	40	575	555	Granite	Poor (Caving)	23.3	
11					686	608	Granite	Fair	22.9	
12	376	32	86	35	588	656	Schist	Fair	25.5	
					529	645	Granite	Good	29.3	

operated almost continuously until Oct. 19, 1911. Each machine was operated two 12-hour shifts per day; for the first ten months they were operated seven days per week, and after that no drilling was attempted on Sundays and holidays, except in case of hole trouble, caving or fishing for tools. This system of "days off" kept the men in much better condition, resulting in a more steady crew and an increased footage per month.

All-steel Mother Hubbard bits were used, of special design, being especially long and thick. The height of mast, 36 ft. above ground, prevented using anything longer than a 35-ft. string of tools. In a crooked-hole country a 50- or 60-ft. string of tools would be much better than one only 35 ft. long. In Fig. 55, both the Mother Hubbard and the regular form of bit are illustrated.

Most of the holes were started with a 10-in. bit, but 11- and 12-in. bits were tried several times. The larger bits seemed to undercut on a small short stem, resulting in a rough hole. Eight-inch casing was used to follow the 10-in. bit, but seldom could be made to follow to sufficient depth to be of much service. No casing was driven. If it did not go down of its own accord, the next smaller size was used. As a result little or no casing was ever lost. The following bit sizes were used: 8-, 6-, and $4\frac{1}{2}$ -in., with $6\frac{1}{4}$ - and $4\frac{3}{4}$ -in. steel casing.

It was absolutely necessary to continue each bit size as deep as possible, regardless of any caving. This caused more or less trouble, and sometimes necessitated taking long chances, but was the only means of gaining depth with the limited strings of casing. Of course any time the sludge showed copper, the hole was immediately cased. The thickness of the surface-leached material varied considerably, being from a few to 700 to 800 ft., probably an average of 500 to 600 ft.



Fig. 55. Regular and Mother Hubbard Patterns of Churn Drill Bit.

Crooked holes and many other troubles can be prevented to a large extent by proper dressing of the bits. With the thermometer around 100° F., in the shade, it is no easy task to dress *these bits*; hence nearly all drillers are inclined to run a bit too long. A properly dressed bit causes little trouble in the hole.

All moon faces, irregular shapes, etc., should be avoided, and water courses kept open for speed. In many instances fresh bits were put on every 5-ft. screw, and bits were never run for more than 15 to 20 ft. The bit is an all-important factor in drilling, and cannot receive too much attention.

Of course, crooked holes would occur, and these were straightened by dropping cast-iron or rope into the hole. Either of these materials would hold the tools up and permit a shoulder to be cut. Cast iron seems to be the better, as it is more easily removed when the hole has been straightened. Reamers and straighteners were not of much use, probably on account of the extreme difference in hardness of the two sides of the hole. In particularly difficult cases, blasting was resorted to, but as this always caused a cave, it was avoided if possible. When blasting, great care should be exercised to place the shot properly, or more damage than good will result. Various sizes of tin tubes were used, holding from 50 to 100 lbs. of 60% dynamite. One of these tubes was carefully placed at the top of the crook, and then exploded by dropping in a small tin tube 1½-in. in diameter by 18 in. long, containing two sticks of dynamite and two strings of fuse and caps. When blasting under water, the hole should be cleared of casing, otherwise the casing is liable to be split its entire length.

After encountering ore, the upper portion of the hole was cased and the ore then drilled in sections of 20 ft. each, by drilling ahead for casing, drilling for sample, reaming, etc. Owing to caving, it was not always possible to follow this scheme, but it was the system used when conditions permitted. The hole was sampled every 5 ft.

After each foot of drilling, the hole was bailed as clean as possible. When drilling under water the bailer was run 15 times. This seemed more than was necessary, but insured good results.

Two samplers, working 12 hours each, were kept at the rigs, one working the day and one the night shift. When the drills were not in ore, the drillers took care of the sampling, and the sampler was employed in bringing maps and other data up to date. Each driller's footage was recorded, and he knew it; he therefore took care of his monthly footage. The sampler's duties were to prevent errors in depth, etc. The driller bases his measurements on the length of rope, which gives a slightly inaccurate result due to stretching of the rope. The sampler checks these measurements with a steel tape. This division of responsibility between the driller and the sampler permits the driller to give his entire time and attention to drilling, with no chance for excuses.

Everything consistent with good management was done to

make the work agreeable. The drillers were protected by a rough, iron housing. This shed and platform, while costing but little, furnished satisfactory protection from the weather, and could be used over and over again. The bunk and boarding houses were kept to a high standard—so high in fact that they were operated at a loss, but the loss was more than offset by the steady crews and the final cost sheet. A driller was of little or no value until he had completed at least two holes, and had learned the peculiarities of the formation. Both drills were kept close together whenever possible, for convenience in sampling, repairs, water, teaming, casing, use of the fishing tools and general economy.

Analysis of Cost. The costs of 20 months' drilling are shown in Table XXXVI. Table XXXVII is a schedule of time consumed for the different operations and the scale of wages paid. During the first 16 months of drilling, the foreman looked after the rigs and repairing; for the remaining 4½ months this foreman was also a drill runner. With more than two rigs, it is advisable to have a man to act as foreman only.

Regular drilling-machine boilers were used for the first 14 months; for the remaining time 20-hp. auxiliary boilers, mounted on wheels were used. After the installation of these latter boilers, the regular boilers were used for moving only. This arrangement effected a coal saving as follows:

Coal per machine, per 24 hr., regular boilers...	1.37 tons at \$8.30 =	\$11.37
Coal per machine, per 24 hr., auxiliary boilers...	1.07 tons at \$8.30 =	\$ 8.88
Saving	0.30 tons	or \$ 2.49

The above data were calculated for full period of drilling, 20½ months, using steaming hours only.

For the first 13 months depreciation was calculated at \$100; for the remaining 7½ months at \$150 per machine per month.

The cost of the machine, fully equipped with tools, rope, fishing tools, boilers, etc., all on the ground, erected and ready to drill with, was \$7,499. This cost, however, does not include any casing. Both machines, after more than 20 months' use, were in fair condition. Therefore \$125 per machine per month is a proper depreciation charge, provided one contemplates considerable drilling. After the machines were thus fully equipped as above, all tools, repairs, supplies, etc.—in fact everything sent to either rig, was charged out directly against it. Casing was charged out monthly as lost or destroyed.

Detail costs were kept of each hole. The cost per foot appears to increase directly with depth, but, on plotting the cost per foot with depth, too much irregularity was found to determine any positive relation. The last three months of drilling, a total

CABLE DRILLS, AUGERS AND COST DATA 289

of 6,258 ft., was in unusually favorable ground. The average depth of hole for this period was 782 ft., at a total cost per foot of \$1.98. The item of pumping is rather high, as the water is not exceedingly abundant in the district. The water supply was at times inadequate and required steady pumping. The water was pumped from two to four miles, and this long line of pipe, uncovered and over rough country, caused serious trouble and delays, especially in freezing weather. The water requirements

TABLE XXXVI. COST OF DRILLING IN NEW MEXICO

	Jan. 31, 1910, to July 31, 1910. Feet drilled, 12,032. Number of holes, 29. Average depth 415 ft.	Aug. 1, 1910, to Oct. 10, 1911. Feet drilled, 19,072. Number of holes, 28. Average depth 681 ft.	Jan. 31, 1910, to Oct. 19, 1911. Feet drilled, 31,104. Number of holes, 57. Average depth 545 ft.
Labor —	Per ft.	Per ft.	Per ft.
Runners	\$0.320	\$0.477	\$0.420
Helpers	0.224	0.307	0.275
Assaying and sampling	0.151	0.239	0.204
Teaming	0.044	0.075	0.063
Foremen	0.085	0.093	0.090
Clerks	0.019	0.029	0.025
Roads	0.114	0.057	0.080
Total labor	\$0.966	\$1.277	\$1.157
Supplies —			
Fuel and coke	\$0.220	\$0.341	\$0.298
Oils and grease	0.005	0.027	0.018
Road supplies	0.006	0.002	0.004
Cables and sand lines	0.044	0.141	0.104
Drill tools and repairs	0.054	0.133	0.102
Surface tools and repairs	0.004	0.019	0.013
Repairs to machine and boilers	0.016	0.041	0.032
Lighting	0.010	0.007	0.008
Barn supplies	0.023	0.042	0.034
Building material	0.016	0.015	0.015
Chemicals and engineering sup.	0.015	0.038	0.020
Stationery and printing	0.002	0.002	0.002
Telegrams	0.004	0.003	0.003
Transportation	0.028	0.022	0.025
General supplies	0.006	0.032	0.022
Depreciation	0.100	0.172	0.144
Casing	0.005	0.039	0.026
Total	\$0.567	\$1.076	\$0.870
Pumping Plant —			
Labor	\$0.072	\$0.064	\$0.068
Fuel	0.068	0.043	0.052
Oils and grease	0.002	0.005	0.004
Repairs to pump	0.003	0.003	0.003
Repairs to pipe line	0.006	0.019	0.014
Total	\$0.151	\$0.134	\$0.141
Grand total	\$1.684	\$2.487	\$2.177

amounted to from 1,000 to 3,000 gal. per machine per 24 hr., depending on size of hole and whether drilling above or below water-level.

TABLE XXXVII. TIME TABLE OF 20 MONTHS' DRILLING

Time of drilling, months	20
Total feet drilled	31,290
Possible hours drilling *	27,024
Progress per hour of possible time, ft.	1.15
Actual hours drilling	13,342
Progress per hour of time drilled, ft.	2.09
Lost Time —	
	Hours. Pct.
No water	782 2.9
Repairs (machine or tools)	1,531 5.7
No help	1,041 3.8
Fishing	1,314 4.9
Casing and pulling casing	1,472 5.4
Moving and erecting	2,904 10.7
Reaming and bad hole	2,482 9.2
Miscellaneous (rain, sickness, etc.)	231 0.9
Total time lost	11,757 43.5

* Possible machine hours for two machines (each working two 12 hr. shifts) per total time of drilling deducting only Sundays, holidays and a short period when drilling was discontinued.

SCALE OF WAGES

Drillers	\$6 per day of 12 hrs.
Helpers	\$4 per day of 12 hrs.
Samplers	\$110 per month
Mexican labor (roads, etc.)	\$1.75 per day of 9 hrs.
All supplies hauled by wagon 14 miles	\$3.50 per ton

Cost of an Artesian Well. Mr. Wm. G. Fargo gives (*Engineering and Contracting*, Apr. 8, 1908) the following data regarding the cost of an artesian well:

The well was sunk at the Lansing, Mich., sub-station of the Commonwealth Power Co. It was 3 in. in diameter and 107 ft. deep. Of this depth 50 ft. was through soft material and 57 ft. through rock. Only 50 ft. needed sheathing, which was done with 3-in. pipe at a cost of 32 ct. per ft.

The well drilling machine, a small one, was hired for the work, 60 ct. per hr. being paid for the use of the machine and the services of the man to run it. One laborer assisted this man in drilling the well. Record was not kept of the fuel used.

The cost was as follows:

71 hr. use of machine at \$0.60	\$42.60
69 hr. labor at \$0.20	13.80
58 ft. 3-in. pipe at \$0.32	16.00
Total	\$72.40

This gives a cost per foot of well of 67.6 ct., exclusive of fuel.

Cable Drilling in Prospecting in Arizona. (*Engineering and Contracting*, May 4, 1910.) Mr. Wm. G. Weber gives the following relative to work in the Miami district. The ground

to be prospected is divided into 200-ft. squares, each corner being marked as a drill hole location. Roads are then built to these locations, the road work being kept far enough in advance of the drills to avoid delays on this score. As the roads must be at least 9 ft. wide and substantially built, and as the surface of the ground prospected is almost invariably rough, these roads are quite an item of expense. Moreover, since they can seldom be used for any other purpose, they must usually be charged entirely to drilling. The roads should not exceed 15% in grade. A drilling machine can pull up a steeper grade, but the team of horses hauling the coal and supplies must be considered.

Before drilling can be commenced an adequate water supply must be provided, and this is not always easy in the Miami district. Water is pumped from wells, springs, or underground workings, through pipe lines as much as 3 miles in length, to tanks placed at the highest points on the ground to be drilled, and thence through temporary lines to the machines. Between an actual shortage of water in periods of drought and the freezing and bursting of these temporary lines in cold weather, much time may be lost in the shut downs.

The machines now in use in Arizona are of the traction type. Both Keystone and Star outfits are in use. Drilling practice is practically the same in all cases, so the following description of Miami methods is applicable to all.

When a machine arrives at a location, it is blocked and leveled; the drive wheels are disconnected from the engine, and the spudding arm is attached to it. The mast is raised and steadied with wooden braces and with $\frac{5}{8}$ -in. steel guy wires. A floor, 14 x 18 or 20 ft., built of 2-in. plank, is laid in front of the machine; in the summer a simple roof of corrugated iron is built over this floor, sides and ends of the same material being added in winter. A longitudinal opening about 3 ft. wide is left in the roof to allow the handling of casing and tools. Water tanks and a portable coal box are also placed before drilling commences.

The string of tools for starting a hole, or "spudding in," usually consists of a 10-in. bit, 4 in. x 20 ft. auger stem, and rope socket. The tools are strung up, a hole is cut in the floor where they will drop, and "spudding in" commences. When spudding, the cable passes direct from the tools over the crown pulley, down to the spudding wheel, and thence to the drum where the excess cable is wound. This spudding line is generally a section cut from a worn drilling cable; $1\frac{3}{8}$ in. to 2 in. manilla cable is used.

The spudding wheel is moved on an arm in such a way as alternately to raise and drop the tools in the hole. As the depth increases, cable is unwound from the drum, so that the

tools may always strike a fair blow on the bottom. When about 5 ft. of progress has been made, the cable is thrown off the spudding wheel so that it passes direct from the crown pulley to the drum; it is then wound on the latter, pulling the tools out of the hole.

A bailer is then lowered into the hole on $\frac{7}{16}$ -in. steel line wound on a separate reel. The bailer is often made of casing pipe—4 in. to 8 in. in diameter, and 10 ft. to 20 ft. long. A dart valve on the bottom opens when the bottom of the hole is reached, thus admitting the sludge. The bailer is then hoisted to the surface and emptied into a trough which conducts the sludge to the sampling device. The bailer is run until the hole is dry, or all the cuttings have been removed. It is then swung back out of the way, the drilling tools are run back into the hole, and spudding is resumed.

A varying amount of water is needed in the hole to keep the tools cool and to take up the sludge. When the natural flow is not sufficient, this water is thrown in from the surface.

With a Keystone machine, spudding may be continued to a depth of several hundred feet. With a Star machine, however, the wear and tear on machine and cable are too great, and consequently the Star driller "hitches on" as soon as practicable, generally at a depth of from 100 to 125 ft. Then, instead of carrying the motion up over the crown pulley and back again, the rope is attached by clamps and a temper-screw to a beam extending out over the hole, and operated by a crank and pitman. That part of the cable above the clamps is not used while drilling is going on, but is pulled aside out of the way. In pulling out, the cable is unclamped, the pitman taken off the crank and the beam pulled up out of the way, as shown in Fig. 47, and the cable is then wound on the drum just as when spudding. A pair of short-stroke jars is inserted in the string of drilling tools between the stem and the rope-socket.

A drilling crew consists of two men—a driller and a helper or "tool dresser." There are two crews to a machine, each working a 12-hr. shift or "tower," changing at noon and at midnight. When moving or easing, both crews work in the daytime.

Holes are drilled on the average to a depth of 500 ft. or until below the limits of commercial ore. The rate of drilling is quite variable, depending on the rock encountered, the depth, and the amount of water flowing into the hole. With a 10-in. bit in average dry rock, which stands up well, 40 or 50 ft. per shift is not uncommon. On the other hand shattered and silicified schist which tend to cave and settle in the hole, and soft, *sandy schist* and granite which tend to run in at the bottom, are often encountered in the Miami district, and in such ma-

terial, a drill may work a week or so and make little or no progress; in fact, the ground may come in faster than it can be drilled out. The presence of much water in a deep hole may also retard drilling, both by flotation of tools and cable, and by resisting the motion. In such cases it appears advisable to use a wire cable, with 100 to 150 ft. of manilla cable, inserted immediately above the tools to absorb the shock and lessen the strain on the machine. Table XXXV shows in a general way the variations in the rate of progress with respect to depth of hole and nature of work:

It is evident that in very shallow holes, the time required for moving and setting up may become a prominent factor in determination of the average rate of progress. Under delays are included shut-downs, re-drilling bad holes, cleaning out after casing, and except in No. 2, time spent in fishing for tools lost in the hole. A drilling machine is expected to average 750 ft. a month, everything included.

Delays in drilling may be due to various causes, as noted above, some of the chief of these being briefly explained here.

Crooked holes, and flat holes are sometimes encountered. Theoretically a drill hole should always be vertical, round and up to gage, but either through carelessness on the part of the driller or otherwise, variations from the ideal hole are many and troublesome. As a result the bit sticks or the tools lag and do not hit an effective blow. The common remedy is to fill the hole up above the bad place with fragments of quartz gathered on the surface, and then re-drill it. Sometimes a four-winged star bit is used in place of the regular shaped bit and extra wide rope sockets are also used to reduce the play of the upper end of the tools in the hole. Shooting the hole with dynamite is occasionally attempted with rather indifferent success. In spite of all precautions few drill holes are vertical or straight, the tendency being to deflect a foot or two in a hundred.

Cavings, or pieces of rock falling from the sides of a hole may seriously delay drilling, as well as interfere with sampling. Large quantities of rock often fall suddenly on the tools and may wedge them in so tightly as to make it necessary to cut the cable, if indeed it does not break, and fish for them with a second string. Sands running in from below may produce the same effect. These cavings occasionally fill the hole as much as 50 ft. or even more above the bottom, and even if they do not catch the tools, much time is lost removing them. Usually casing the hole will stop the caving. Three sizes of casing are used in Miami, $7\frac{1}{2}$ in., $6\frac{1}{4}$ in. and $4\frac{1}{2}$ in. in diameter, weighing 8 to 13 lb. per ft. When a hole is cased, it is of course necessary to use smaller bits and tools. Four sizes of

bits are used 10 in., $7\frac{5}{8}$ in., $6\frac{1}{4}$ in. and $4\frac{1}{2}$., these figures representing the diameter when dressed to gage. With the last named bits, a smaller string of tools, $3\frac{1}{4}$ in. in diameter, is used.

A hole may thus be cased several times if necessary. Each size of casing reaches to the top of the hole, and all are removed when the hole is finished. When casing is being handled, the drilling tools are lashed to the mast, and usually the manilla cable is unwound from the drum, a wire cable being put on in its place. With this line, the joints of casing, each 18 ft. to 20 ft. long, are hoisted up, over the hole one by one, threaded together and lowered until the bottom is reached, or until they will go no further. The casing rarely needs to be driven, and then only with light blows, this being accomplished by stringing up the tools and dropping them gently on a block placed on the upper joint of the casing.

To remove casing the process of lowering is reversed. When it does not pull readily, pulley blocks or hydraulic jacks or both are used, and occasionally dynamite is lowered into the hole and exploded to jar the ground loose. There are also a number of special tools, such as steel nipples, casing spears and the like, used in special cases and better described in the makers' catalogues than is possible here.

Finally, a serious factor in delaying drilling is the fishing job. The cable or one of the tools may break, a joint may become unscrewed, or the tools may be wedged so tightly by sudden falls of ground or runs of sand, that the jars will not work and the rope must be cut. Then the fishing job commences. Many and various tools are kept ready for emergencies, for it takes weeks to get anything from the supply houses. A fishing job is delightfully uncertain; it may last an hour or a week, or the hole may eventually have to be abandoned. In the last case, a new hole is usually started a few feet away. A second and a third string of tools may be lowered into a hole, to recover the ones already there, only to be lost in turn. Sometimes when success seems assured, some unexpected occurrence puts things in worse shape than before. Thus in one hole, a bit broke off at the pin, and the driller lowered a horn socket gently, to feel for the part remaining and learn, if possible, how it lay. The horn socket is aptly described by its name—resembling a megaphone somewhat, in shape—and in this case it slipped over the bit and took just enough friction hold to bring it along to the surface and then drop it back in the hole, where it remains yet, all further efforts to recover it proving unavailing.

The object of this drilling is, of course, to obtain information concerning the ground penetrated. For this purpose the sludge is bailed out at 5 ft. intervals, approximately the true depth being

determined each time by measuring on the boiler line. The sludge is dumped into a trough and conducted to a split divider which diverts $\frac{1}{8}$ of the material into a tub. This amount may subsequently be reduced to $\frac{1}{16}$, $\frac{1}{32}$, or $\frac{1}{64}$ if desired, by repouring the contents of the tub through the divider. The sludge is then dried over a fire, care being taken to prevent loss of sulphur through roasting; and the dried sample—which should weigh 25 or 30 lb.—is sacked, tagged with the number of the hole and the depth at which it was obtained, and sent to the assay office. A sampler is employed on each shift to do this work. When two machines are working close together he can attend to both. He also takes a portion of each sample and pans it, noting the copper and iron minerals present, and their approximate abundance. The sulphides and oxides concentrate in the bottom of the pan; the copper carbonates and silicates are washed off, but may readily be detected even in minute quantities because of their bright colors. This and other information is recorded on a report blank.

The nature of the rock penetrated may be determined by the relative quantities of various minerals found in the sludge, and also by examination of such small uncrushed fragments as are often bailed out. When the formation is not the same from top to bottom, and the hole is caving, the exact nature of the rock penetrated may be indeterminable.

Faults and veins are quite readily detected in the capping over the ore through the presence of clay in the sample, also through marked variations in the amounts of iron oxides, copper carbonates, or quartz present in the sample. The width of the fault is represented by the distance through which this marked difference in mineralization occurs, but when the fault is steeply inclined, this is of course much greater than the true width. Faults in the sulphide zone are not so readily detected and doubtless are often overlooked.

Too much reliance should not be placed on the results obtained by drilling. Raises have been put up on a number of holes both at Ray and Miami, and while in some cases the drill returns and those from the raise check out quite satisfactorily, in other cases very poor results are obtained. A variation as great as 0.5% has been found to occur in ores averaging 3% or less. As a rule, the drill returns are low, a fact which is rather hard to explain. It is possible that the heavy sulphides tend to settle in the bottom of the hole and in fissures and pockets in the sides where they are undisturbed by the churning of the tools. In uncased holes, cavings from the overburden would of course lower the percentage of copper, and on the other hand, it has been found that after the hole has passed through a sulphide body, the samples may still indicate good ore. Under such conditions, casing changes the grade of samples materially.

Moreover, it is so easy for a careless sampler to neglect

his work, especially at night. An unwashed trough may collect much concentrate; an uncleaned divider may clog and not split the sludge properly. Allowing the solids in a sample to settle and decanting off most of the water before placing the tub over a fire, is a common and legitimate practice—but too often much solid matter is allowed to float out with the water.

However, regarded not as a means of developing ore bodies, but as a means of prospecting for them, determining their boundaries and obtaining a fairly close idea as to their tenor, the churn drilling machine is certainly a rapid, efficient and comparatively cheap instrument.

The drills are owned and operated by the mining and development companies, and no contract work has as yet been attempted in the territory.

The accompanying cost data are based on an assumed average life of four years per machine. A drilling machine with tools sufficient to operate for that length of time would cost about \$6,000.

The minimum amount of road required per hole is about 300 ft. When holes are drilled at 400 ft., 600 ft., or greater intervals, the item of roads becomes correspondingly greater. On the fairly steep slopes (20°) encountered in the Miami district, \$0.75 is an average cost per foot of road.

COST OF DRILLING.

Labor —		Per ft. of hole.
2 drillers at \$6.00 per day	\$.48	
2 helpers at \$4.80 per day38	
1 sampler at \$4.00 per day16	
1 foreman at \$6.00 per day (2 machines)....	.12	
	<hr/>	
	\$1.14	\$1.14
Roads —		
Labor at \$2.00 per day	\$.50	
Foreman at \$4.00 per day05	
Powder, caps and fuse03	
Tools, etc.01	
	<hr/>	
	\$.59	\$.59
Coal, coke, oils, etc.27	
Water10	
Teaming10	
Assaying, office and incidentals, etc.16	
Interest at 5 per cent. and depreciation20	
	<hr/>	
Total cost per ft. of hole	\$2.56	

The monthly average of the cost per foot of hole drilled varies with one company from \$2.00 to \$3.00. In another instance, where holes are drilled further apart and the drilling is poorer, the cost per foot has run as high as \$5. When drilling is the only means of development being used on a property, the cost of *camp* maintenance and incidentals considerably swells the cost account. It would hardly be fair, however, to charge these items up to drilling when a comparison with other districts is being made.

Cost of Drilling Test Holes. This drilling was done with a Star drilling machine (see *Engineering and Contracting*, Mar. 4, 1908) to test the site of a double track, steel trestle for concrete pedestal foundations. Seven holes were put down for a total depth of 190 ft. through clay and gravel to solid rock. The average depth of soil was 23 ft. and the average penetration into rock was 4 ft. The actual time consumed in drilling and moving from one hole to another was 11½ days and the total distance over which the drill was moved was 730 ft. The average time per foot of hole drilled, including moving, was 30 min. The contractor furnished the drill and labor at cost plus 10% on labor, and his bill was as follows:

	Rate	Total	Per ft.
Driller, 11½ days	\$3.50	\$40.25	\$0.212
Helper, 11½ days	1.75	20.13	.106
Teaming, 2.1 days	4.00	8.40	.044
Labor, 10 days	1.75	17.50	.092
Use of drill, 11½ days	2.00	23.00	.121
Coal, 45 bushels08	3.60	.018
4½ in. casing, 54½ ft.35	19.13	.100
Teaming, 1 day for other parties	4.00	.021
10% for Supt. and use of tools as above	8.63	.046
Total		\$144.64	\$0.760

The above cost does not include any charge for inspection, as the regular inspector for the railroad company had to be on the ground to watch other work and could easily keep track of the drilling. The above information was furnished by H. M. Chapin, Resident Engineer, F. & C. R. R.

Rotary Auger Drills. These machines vary from a simple ship auger operated by hand to a tripod or column mounted drill operated by hand, air or electric power. The drill bits are spiral or oval shaped and are capable of boring holes 5 or 6 in. in diameter in soft ground, such as coal, slate, shale, salt gypsum, and very soft rock. The approximate weight and prices of rotary auger drills are as follows:

	Weight complete, lbs.	Approximate price.
Electric drills, mounted	250	\$250
Air drills, mounted	260	165
Hand drills, mounted	80 to 100	\$30 to \$70
Hand drills, augers	150	10

The Ingersoll-Rand "Little David" boring machine may be used with an auger bit in very soft materials. The "Jack-hammer," ordinarily used with 7/8-in. hollow hexagon steel, may be fitted with an auger bit made from twisted diamond shaped steel with a flat or bull nosed bit, and may be used for boring soft materials. This outfit will bore a 6-ft. hole in 5 to 10 minutes.

Driving a Water Well with a Rotary Rig at Dallas, Texas. (*Engineering and Contracting*, June 14, 1916.)

The well is 2,850 ft. deep and was driven for the Southern

Methodist University at Dallas. Its feature of principal interest is the method of sealing the well by cementation against entrance of all waters except those from the Trinity sands. The driving methods as described by Ernest L. Myers, Myers & Noyes, Engineers, Dallas, Tex., in a paper for the Southwestern Water Works Association, were as follows:

A contract and specifications were prepared for a well to the

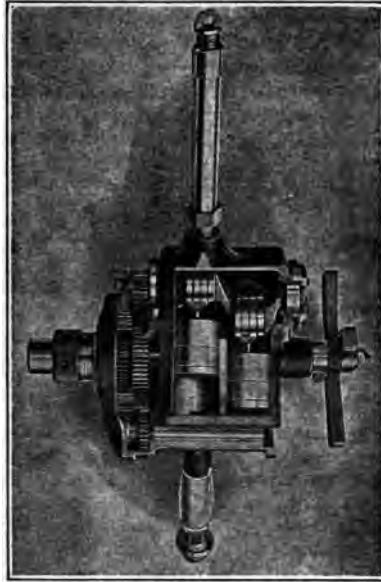

Fig. 56. "Little David" Drill Partly in Section.

Trinity Sands and bids called for. Bids were secured ranging from \$20,000 to \$23,500 for the well complete. The bid of J. E. Faucett & Co., of Dallas, for \$20,000 was accepted, and the contract signed June 2, 1915. Drilling was begun July 1, and completed Oct. 17. Two days were lost due to a severe storm and ten days were lost allowing the cement to set after cementing the 6-in. casing. The total depth of the well is 2,850 ft. The time of actual drilling was 67 days, which is a record in this locality for a well of like depth. There was no loss of time due to loss of tools or like mishaps. A small amount of time was lost repairing the engines and pumps and sharpening the bits.

The contractor provided himself with the most up-to-date

equipment, including a special section of square drill stem with a grooved roller device for gripping it in the rotary. Also corrugated, tapered wedges for gripping and holding the drill line when coming out or going in the hole. The standard heavy rotary type well rig was used in drilling the well. The derrick was 113 ft. in height and constructed in a very substantial manner. The 6-in. drill stem was of heavy steel casing, equipped with tapered tool steel joints and extra long heavy couplings. The 4-in. drill stem was of extra heavy Reading drill pipe, equipped with tapered tool steel joints. Only the square drill stem and one section of special drill pipe was used through the rotary. This prevented any damage to the balance of the casing in drilling. The heavy tongs and elevators were swung in the derrick by means of hooks and cables, making them easy to handle and decreasing the amount of heavy lifting necessary.

Oil fuel was used under the boiler and was piped from a railway switch in the rear of the main university buildings, one-half mile from the site of the well. The water for drilling and boiler use was obtained principally by constructing a low earth and sack dam in Turtle Creek. Considerable trouble was experienced from leakage under the dam, due to the smooth rock bed of the creek. The leakage was partially stopped by pumping drill mud into the pond above the dam.

The hole was started 14 in. in diameter. After passing through 6 ft. of surface soil, a soft lime rock, locally called "White Rock," was encountered. At 13½ ft. a 12-in. surface casing was set. The size of the hole was then reduced to 10½ in. in diameter. After passing through 159 ft. of White Rock, shale interlayed with shallow layers of lime rock was encountered to a depth of 408 ft. From this point down to a depth of 672 ft. the formation was largely of gumbo. At this depth the first of the Woodbine sands was struck. Water sands interlayed with streaks of gumbo, shale and some lime rock were encountered down to 998 ft. The heaviest as well as the deepest strata of Woodbine water bearing sand were 51 ft. in thickness.

The Weatherford limestone was encountered at 1,063 ft. With the exception of thin layers of gumbo and shale this formation continued to the upper Paluxy Water sands at 1,617 ft. At a depth of 1,789 ft. the 8-in. casing was set in hard lime rock. The hole was then reduced to 7½ in. in diameter. The Paluxy sands interspersed with thin layers of limestone and gumbo continued to 1,764 ft. This material caused very hard, slow drilling.

The thickest layer of Paluxy water sand encountered was 42 ft. in depth, lying between 1,638 and 1,730 ft. After passing out of the Paluxy water sands, alternating layers of gumbo and lime rock, with some sand and boulders were encountered to 1,945 ft.

From 1,945 ft. to 2,291 ft. the formation was principally of very hard lime rock. At 2,291 ft. the upper layer of the Glen Rose water sand was struck. The Glen Rose water sands interlayed with numerous layers of red gumbo and very hard sand rock extended to 2,448 ft. The upper and thickest layer was 44 ft. in depth.

From 2,448 to 2,523 ft. the formation consisted of relatively thin layers of hard lime and sand rocks. From 2,523 to 2,603 ft. thin layers of red shale, gumbo and sand rock were encountered. At 2,603 ft. the cap rock of the Trinity sands was struck. This was a very hard sandstone formation. At 2,630 ft. the 6-in. casing was set and cemented in place. The size of the hole was then reduced to 5½ in. in diameter.

After drilling 2½ ft. the softer, water-bearing Trinity sand was struck. At 2,770 ft. a layer of hard sand and lime rock 8 ft. thick was struck. Passing through this formation Trinity sands were again encountered. At 2,807 ft. drilling passed out of the Trinity sands. Drilling was continued to 2,850 ft., passing through lime and sand rock and shale. At this point it was considered unnecessary to drill further, as it was believed that the last of the Trinity sands were passed through.

After reaming the hole, 243 ft. of 4½-in. perforated liner was set. The liner had 75 ½-in. holes per foot in depth. The well was then equipped with agate valve and delivery pipe and allowed to flow freely for several days, to clear itself of drill mud and loose sand. The well began flowing soon after passing through the cap rock, but did not flow in any considerable amount until the drilling had penetrated well into the strata. At the time of completing the well, the water rose in drill pipe to a height of 65 to 75 ft. above the ground level. Weir measurements indicated a flow of a half million gallons per 24 hours.

Cementing Casing. The principal feature in which this well differs from the other deep water wells constructed in this locality, is the method of casing off the waters other than that of the Trinity Sands Strata. This was done by surrounding the 6-in. casing for several hundred feet with cement grout. This cement grout extending from the Trinity Sands upward to, or near, the lower end of the 8-in. casing.

Although the cementing process is a very common one in the oil fields of Louisiana and also in California, little information is available in regard to the method. Two papers are available on this subject: One by Paul M. Paine, in *Transactions, American Society of Civil Engineers*, Dec., 1913, on methods used in cementing deep wells in California; and the other describing *the methods used in cementing the oil wells of Louisiana to prevent the entrance of salt water into the wells.*

The first describes the method commonly used in California, which is to introduce a small pipe, extending to the bottom of the well, inside the casing to be set. A tight joint is then made between the top of the casing and the small pipe. The casing is then lifted clear of the bottom and cement grout pumped down through the small pipe to the bottom of the well. The casing being filled with drill mud, confined by the tight joint at the top, the grout is forced up around the outside of the casing filling the space between the casing and the walls of the hole.

The method described in the second paper is called the plug method. It is used with success in the Louisiana field. This method is much simpler and is inexpensive. In this method the casing is first set in the well and bailed down for several hundred feet, depending on the amount of cement to be used. A plug loosely fitting the casing is then dropped in and the cement grout poured in on top of this plug. A second plug is then introduced on top of the cement. Connection with the pump is made to the top of the casing, and the casing lifted clear of the bottom of the hole. The pump is then started. The plugs, with the column of grout between them are forced downward to the bottom of the well, the drill mud below the bottom plug being forced out and up around the casing. Upon reaching the bottom of the hole the lower plug cuts off the circulation, stalling the pump. The casing is then raised just enough to allow the lower plug to pass out. The lower plug clears the casing of mud as it advances and upon passing out of the bottom of the casing allows the cement grout to be forced upward around the outside of the casing, filling the space between the casing and the walls of the hole. When the top plug reaches the bottom of the well, it is prevented from passing out by the lower plug and the circulation is stopped. The casing is again seated on the bottom of the hole and the well allowed to stand from ten days to two weeks before resuming drilling.

It was decided to use the plug method in cementing the University Well, because of its simplicity and the familiarity of the local drillers with this method. The cap rock of the Trinity Sands was reached on Sept. 26, but as there was some doubt of its being the cap rock of the Trinity Sands, drilling was continued for a depth of 27 ft. into the formation. After penetrating to this depth it was decided that there was little doubt of this being the cap rock of the Trinity Sands and it was decided to set the 6-in. casing. On the night of Oct. 28 the 6-in. casing was started in the hole and by the middle of the next forenoon was seated on the cap rock, an ordinary set shoe being used on the bottom of the 6-in. casing.

Eleven hundred feet of the 4-in. drill stem with the lower end plugged was run into the 6-in. casing to bail the well. This forced the drill mud to flow out over the top of the casing so that when the drill pipe was withdrawn the casing was empty for a depth of from 300 to 400 ft. from the top.

A large mixing box 16 ft. long by 5 ft. in width by $1\frac{1}{2}$ ft. in depth, having a gate in one end, was built on the platform of the derrick. A short trough was run from the gate to the top of the 6-in. casing. A batch of 20 sacks of cement and 40 sacks of sand was mixed in the box and water added to make a very thin paste. Mixing was continued until the paste was run into the well.

A circular wooden plug 2 ft. in length, which had previously been passed through a section of 6-in. casing to make sure that it would not lodge, was dropped in on top of the drill mud remaining in the casing. This plug had a folded cement sack fastened to its top to prevent any cement passing the plug. The 6-in. casing was lifted clear of the bottom of the hole. The cement grout was then run in on top of the plug as quickly as possible. The upper plug, which was similar to the lower plug, except that it had a stick 3 or 4 ft. in length projecting downward from its lower end, was dropped in on top of the grout. The swivel connection was then screwed onto the top of the casing and the pump started. After some minutes the mud began to flow from between the 6 and 8-in. casings, showing that circulation had begun.

After a period of 15 min. had elapsed the pump came to a dead stop, indicating that the lower plug had reached the bottom of the hole, entirely cutting off the circulation. The 6-in. casing was then lifted sufficiently to allow the plug to pass out and circulation was again established.

After the first plug had passed out the pump gradually began to slow down, due to the great pressure necessary to force the heavy cement grout upward through the small cavity surrounding the casing. The pump slowed down to such an extent near the end that it was feared that it would stop before the top plug reached bottom. After about 45 min. of pumping the pump stalled. The pump was operating at so low a speed at the time that some doubt was felt as to whether the top plug had reached the bottom or whether the load had become too great for the pump.

The 6-in. casing was then lowered upon bottom, but failed to go to its original seat by about 6 or 8-in. This may have been due to the cavings in the hole or to sand settling out of the grout, *as the sand which was used showed a tendency to do this in the mixing box.*

The well was then allowed to stand undisturbed for a period of five days. The 4-in. drill pipe was then run in and the 6-in. casing washed free from mud. The plugs were found to be on bottom. After 10 days' time drilling was again resumed. The plugs and the small amount of grout remaining in the casing was drilled out. After drilling 2½ ft. the cap rock was passed through and the soft water sand struck. The well began to flow soon after and the flow gradually increased until drilling had progressed well toward the bottom of the sand.

Improved Methods of Deep Cable Drilling in California. In *Transactions, American Institute of Mining Engineers*, 1916, Mr. M. E. Lombardi gives the following:

The Coalinga oil field is located on the west side of the San Joaquin Valley, California. The structure is in general a monocline, the edges of the oil horizon resting on the foot hills and dipping gently toward the east. One prominent anticline occurs plunging southeast. The earlier drilling was done in the foot hills comparatively near the outcrop, and the wells were shallow. The sands were followed eastward and, in the case of the anticline, along the plunge, the wells becoming deeper and deeper until the depth of 4,000 ft. was reached and passed. There is nothing to show that the oil will not be found in quantity at still greater depth. In fact, some of the best producers have tapped the sand at close to 4,000 ft. The recovery of oil still farther to the east, and therefore at greater depth, seems to be mainly a question of drilling.

In this territory the formations drilled through are chiefly sands and shales; they will not "stand up" in an open drilling hole; the casing has to be carried close to the bit, and it is always difficult to keep the casing free for any considerable distance.

Ability to carry casing of comparatively large diameter with-out conductor pipes for distances of 2,000 or 3,000 ft. or over is desirable in such territory chiefly for two reasons. It makes it possible to enter the oil sand with a pipe of ample diameter; it eliminates one or more extensive strings of casing which act only as conductors for the water string, and furthermore, in territory where waters are encountered which corrode steel rapidly, it makes possible the construction of a rust- and alkali-resisting water string.

It is always desirable to shut off top waters, which may lie within 100 ft. or less of the oil sand, with 10-in. pipe. Where the depth is so great that a practical weight of 10-in. pipe will not withstand the probable collapsing pressures, 8¼ in. at least is desirable.

About the limit of rotary drilling to date in California seems to be the setting of the 10-in. string at 3,200 ft., although the

rapid advance in rotary work during the past year seems to indicate that this depth may soon be increased. This article, however, treats only of cable-tool drilling.

The problem is to reach a depth of 4,000 ft. or more with a string of pipe not less than 8¼ in. in diameter for shutting off top water, and to reach it with this string free and movable and using in the upper part of the hole the minimum of conductor casings.

In the Coalinga field some very promising results have recently been obtained by a method, or combination of methods, effected by William Keck. In one well a 15½-in. string was set at 2,300 ft., and a 12½-in. string through this at 3,003 ft., these being the only strings used in the well to that depth and both being landed when they were entirely free. In another well a 15½-in. string was set at 2,100 ft. and through this a 10-in. string at 3,300 ft.; in this case also the strings were perfectly free when landed and were stopped only because it was not desired to carry them deeper. Other wells have shown similar results.

It will be noted that the 15½-in. strings were free with over 2,000 ft. of "friction" on them, and this in a territory that will not "stand up" with ordinary drilling more than 40 or 50 ft. ahead of the pipe.

The drilling detail used on these wells is briefly as follows: A large clearance for the pipe is obtained; the standard circular system is used; the pipe is kept moving while drilling is in progress; each collar is "set up" twice before it goes below the bottom of the derrick cellar.

The large clearance is obtained by the use of a shoe of extra large diameter, from 1¼ to 1¾ in. larger than the collars on the pipe. Under-reaming is resorted to frequently and the hole is repeatedly under-reamed until the pipe is entirely free in passing a "shell" or hard streak. Spudding the pipe is avoided. When a conductor pipe is landed, the desirable extra clearance for the next string may be obtained by skipping one size of pipe, as for instance carrying a 10-in. string through a 15½-in., thus eliminating the 12½-in. size. This is necessary with the present sizes of pipe available, but a different design, which will be mentioned later, would save considerable expense in this matter.

This extra clearance is necessary in using the circulator system to allow free passage for the "returns." It obviates the danger of sand lodging between the strings of pipe and freezing the working string.

The well-known standard circulator system is used. Mud (clay) laden fluid is forced down through the pipe under pressure by pumps (ordinary rotary slush pumps) and returned on the outside of the pipe, carrying the drilling with it. This fluid is

run through a flume and into a pit, as in rotary work, and its consistency is regulated as with the rotary.

This mud-laden fluid presumably plasters up the walls of the hole, prevents sand and mud from running in and prevents caving. It is essential that circulation be interrupted as little as possible. Intermittent circulation seems to be worse than useless. The pipe is kept moving while drilling is in progress—i.e.,

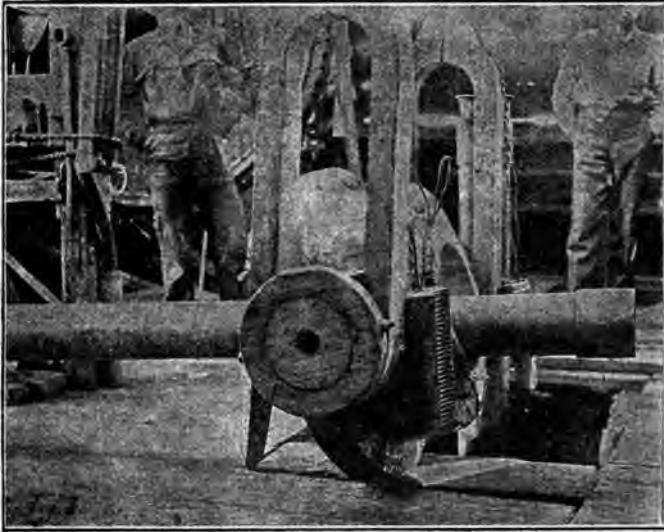

Fig. 56-A. Swing Spider.

without pulling out the tools—by means of a so-called swinging spider, see Figs. 56-A and B. The pipe is suspended by an ordinary spider provided with lugs to which are attached steel reins (sometimes chains or wire lines), which extend to a clevis above the walking beam, the beam operating between the reins. The clevis is attached to the casing block. The reins are about 40 ft. in length so that the pipe may be lowered to the bottom of a 30-ft. cellar. The cellar is made deep enough so that the stationary spider at the bottom is more than the length of one joint of pipe below the derrick floor. It follows that when a joint of pipe is added to the string the back-up tongs may be put out on the second collar, which has been previously set up and which is now near the cellar bottom. The same result is obtained without back-up tongs, the pipe being held by the lower spider.

Thus every joint is set up twice—once when it is put on and a second time after it has been subjected to the pull of the pipe below it and the vibration of drilling. This insures a tight joint.

It is by a combination of the above details and careful attention to them that success in carrying pipe has been attained.

Other advantages are obtained as by-products of this method. The pipe is always free and the circulation perfect for cementing, the mud being easily washed out ahead of clean water. There is almost total elimination of bailing out drillings, with its consequent loss of time. A lifting pressure may be put against the closed top of the casing, thus relieving to some degree the strain on the casing line. For instance, a 12½-in. casing has an area of about 121 sq. in.; a pumping pressure of 200 lb. per in. against this means 24,200 lb. taken off the effective weight of the casing. Naturally the pressure runs up if the pipe becomes lodged and that is when it is most needed.

The mud-laden fluid as usually used has a specific gravity of about 1.40; therefore, its pressure in holding back artesian water, running sand, etc., is 1.4 times as much as clear water. It is a well-known fact that this mud-laden fluid tends to kill gas (see *Technical Paper No. 66, U. S. Bureau of Mines, Mud-Laden Fluid Applied to Well Drilling*), although it is the writer's opinion that the capillary action of water in sand has as much to do with holding back gas pressure as anything.

It has been suggested that in territory where upper waters corrode iron and steel very fast, a 10-in. water string practically immune to this corrosion may be obtained as follows:

Carry a 12½-in. string within a few feet of the point where water is to be shut off. This string may be as light and cheap as it is practical to carry, since the burden of sustaining the collapsing pressure of the water does not fall on it. Then land a 10-in. water string inside of this 12½-in. string at the proper point below it, and pump in enough cement to fill the space between the two strings.

This is mentioned simply as one of the advantages which may accrue from a drilling method by which a large-diameter string of pipe can be carried to depth with reasonable certainty.

Now as to the interesting item of cost. The bulk of the extra cost incurred is in movable tools and machinery, only the depreciation and upkeep on which are chargeable to the well drilled. Extra cost incidental to the drilling itself, other than above, consists in construction of the deep cellar, the installation of one extra boiler, the mud pumps and the extra fuel and water used, and one extra man. The swinging spider, pumps, boiler, etc., are, of course, moved and used for successive wells.

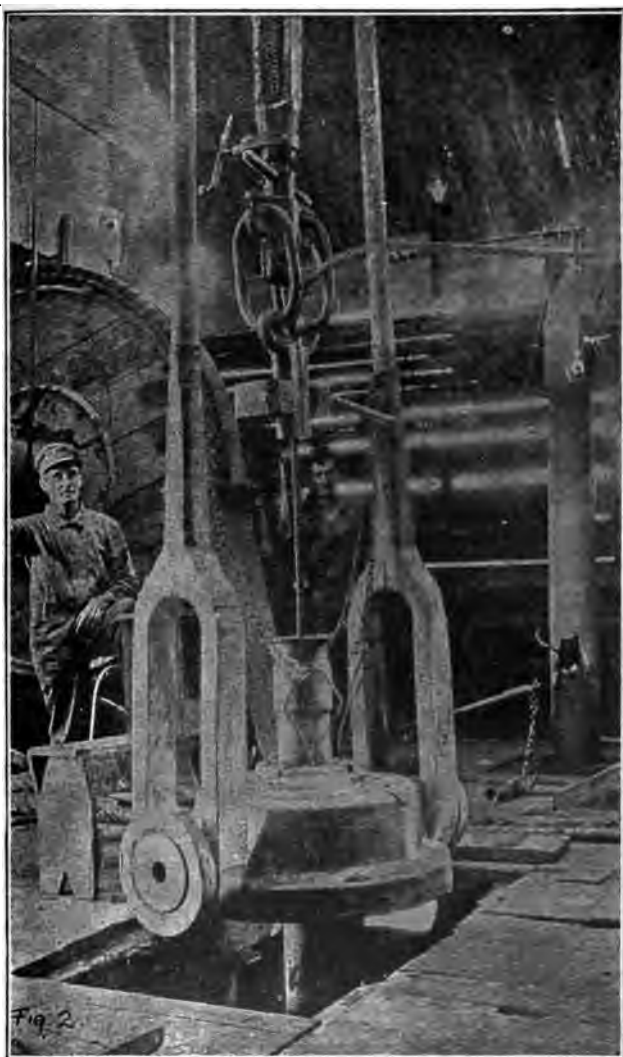

Fig. 56-B. Temper Screw with Clamps on Drilling Line Between Reins of Drilling Spider.

An idea of the extra cost items may be gained from the following:

Extra depth of cellar, drain, and circulator rigging.....		\$450.00
Setting of extra boiler and circulator pump		250.00
Mud flume, pits, etc.		100.00
		<hr/>
Total fixed costs per well		\$800.00
Extra labor in drilling, per day	\$7.00	
Extra fuel, 7 bbl. of oil per day at 35 ct.	2.45	
Extra water, packing, etc., per day	4.00	
		<hr/>
Total extra costs per day for 122 days	\$13.45	1,640.90
Depreciation at 18 per cent. on \$2,320, being value of outfit removed		136.00
		<hr/>
Total extra cost		\$2,576.90

In a typical well with the system under discussion 3,336 ft. of 10-in. pipe was set in 122 days.

This is the value of only about 1,465 ft. of 12½-in. 45-lb. casing f.o.b. the field. No 12½-in. casing was used, so at least this amount was saved.

Better average time is made with this method, so that at the most it is not more costly than the usual cable-tool drilling. As pointed out, its chief value lies in the fact that large-diameter pipe can be carried to depth with far more certainty.

It is impossible to leave this subject without a few suggestions for the future; in other words, indulging in a mental construction of an ideal drilling outfit, built along lines following the above described method.

A greater clearance between consecutive size strings of casing is essential. In order to shut off water with a certain size string, the conductor used, be it long or short, should have an inside diameter at least 1¾-in. greater than the outside diameter of the collars on the water string. Since the water string will have to stand great collapsing pressure and must therefore have very thick walls, a clearance should be provided in it so that the oil string may be worked without difficulty.

If it is desired to use an 8¼-in. oil string, it follows that the water string should be at least 10½ in., inside diameter, which would be obtained in a casing of 10⅝ in. nominal diameter weighing from 55 to 60 lb. per ft. This would call for a 14-in. conductor.

Requirements for the ideal casing are:

Sufficient thickness of walls to withstand the water pressure; joints that will hold on a maximum pull; threads that will stand being set up several times; reduction of weight near the top of the string.

To meet these requirements the casing will have to be heavy on the bottom and light on top, but the top part will have to

stand the greatest pull. Obviously an upset-end casing, upset on the outside, would be the thing for the top part of the string. Furthermore, with these upsets and with the thickness of the wall necessary on the bottom of the string, eight threads per inch could safely be used in the joints. It is well known that eight

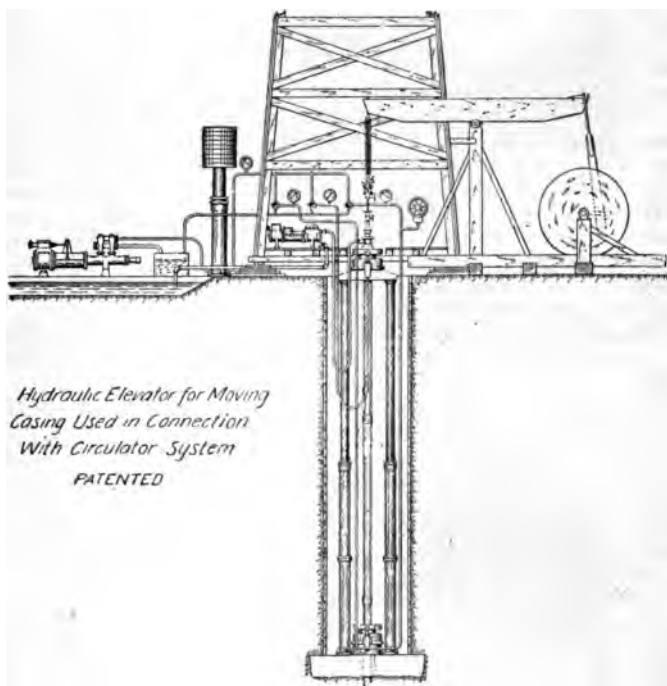

Fig. 56-C. Hydraulic Elevator for Moving Casing, Used in Connection with Circulator System. (Patented.)

threads will stand more unscrewing and screwing up, more driving and, in general, more "grief" than the customary 10 threads.

Collars may be built correspondingly heavy since excess clearance is obtained anyhow. In explanation of the desirability of using eight threads it should be said that in carrying a string of casing a long distance there are generally accidents, such as pinching a shoe, etc., which necessitate pulling and putting back the casing before it is finally landed.

The swinging spider, although efficient, is clumsy. In moving

casing with it in the ordinary way, the entire strain (sometimes 80 tons or more of casing, plus friction of the mud between the casing and the walls of the hole, must be moved) is transmitted to the crown block on top of the derrick. To obviate this and carry the greatest strains on solid foundation, a hydraulic elevator operating in the cellar might be used. Such an elevator with a lift of 22 ft. has been devised, but never used. (See Fig. 56-C.) By its use pipe could be kept moving all the time, and all hard pulls taken off the crown block. Of course, the ordinary elevators and calf wheel would still have to be used for putting in and pulling strings of pipe, but the heavy work could be carried by the hydraulic elevator in the cellar, and the cost of constant repairs to the derrick considerably lightened. Pulling in of derricks, with consequent delays, frozen pipe, and danger to life, now far too frequent, would be almost entirely done away with. With the above suggested improvements, it seems reasonable to expect that an 8¼, 10, or 10⅞-in. water string, with only a few hundred feet of conductor, could be carried in the territory under discussion to 4,000 ft. or more.

The Rotary Well Drill. In *Transactions, American Institute of Mining Engineers*, 1915, Mr. Howard R. Hughes gives the following:

In drilling for water and oil to reasonable depths through the generally soft yielding clay and sand formation of the Coastal Plain of Texas, Louisiana, and Mississippi, the rotating method of drilling was adopted, principally on account of the easy and quick penetration, and the low cost of the drilling plant.

In favorable ground, free of heavy gravel and rock strata, as much as 1,000 ft. has been drilled in less than 36 hr., although such performances were of course rare.

Hydraulic rotary drilling, or, as it is now called, rotary drilling, was used in the above States as early as 1880. The plant consisted of an ordinary derrick, a 25-hp. boiler, a small hoist, a steam pump, and a water swivel with hose attachment, and an ordinary flat diamond-pointed bit.

The successful drilling in of a phenomenal oil well by this process on Spindletop, near Beaumont, Texas, on Jan. 10, 1901, and the ascertained impracticability of drilling subsequent wells in the same locality by other methods (owing principally to heavy quicksand under pressure from below), brought rotary drilling into great prominence, practically to the exclusion of any other process throughout the Coastal Plain, and later on elsewhere.

The method, as its name implies, involves the rotation of a *pipe by means of machinery placed on the derrick floor. A drill bit attached to the lower end cuts a clearance for the drill pipe,*

with much the same motion and effect as an augur. Water forced through the drill pipe by means of a pump, and escaping through the bit, removes the cuttings and returns to the surface *outside* the drill pipe. In this manner the hole is kept open, permitting the drill stem to rotate freely.



Fig. 56-D. Fishtail Bit.

The pressure of the column of muddy water holds up the walls of the hole until it has been cased.

Practically all the wells of the Gulf coast region, numbering nearly 10,000, have been drilled with this system. During the



Fig. 56-E. Sharp & Hughes Cone Bit.

last five years its use has been extended to many other States and countries.

The great drawback hitherto has been the slow progress made in drilling rock and other hard formations. For soft, caving formations no other system can approach it in efficiency.

The old style bit in general use is known as the fishtail type, as shown in Fig. 56-D. Having only two cutting edges it soon grinds down flat when hard rock is encountered. At times only a few inches a day can be made with it. The racking and wrenching to which the machinery and drill pipe are subjected, when drilling a hole from 4 to 18 in. in diameter, result often in twist-



Fig. 56-F. Broadside View of Sharp & Hughes Cone Bit.

offs of the drill stem and costly fishing jobs. With the use of the heavier rigs and deeper drilling the need for a bit adapted to cutting rock became a crying necessity.

It was to meet this need that the cone bit, known as the Sharp & Hughes, was invented by H. R. Hughes in 1908.

In brief, it consists of two or more detachable, cone-shaped cutters of hardened steel (see Fig. 56-E, F and G). These *cutting cones* revolve on bronzed bearings, lubricated with a special *heavy viscous oil* supplied by means of a small pipe carried in-

side the drill stem (see Fig. 56-F). The cutters, being detachable, may be removed and sharpened when dull.

The old style fishtail bit scraped its way through the rock encountered. With hard rock or sandstone it soon wore flat,

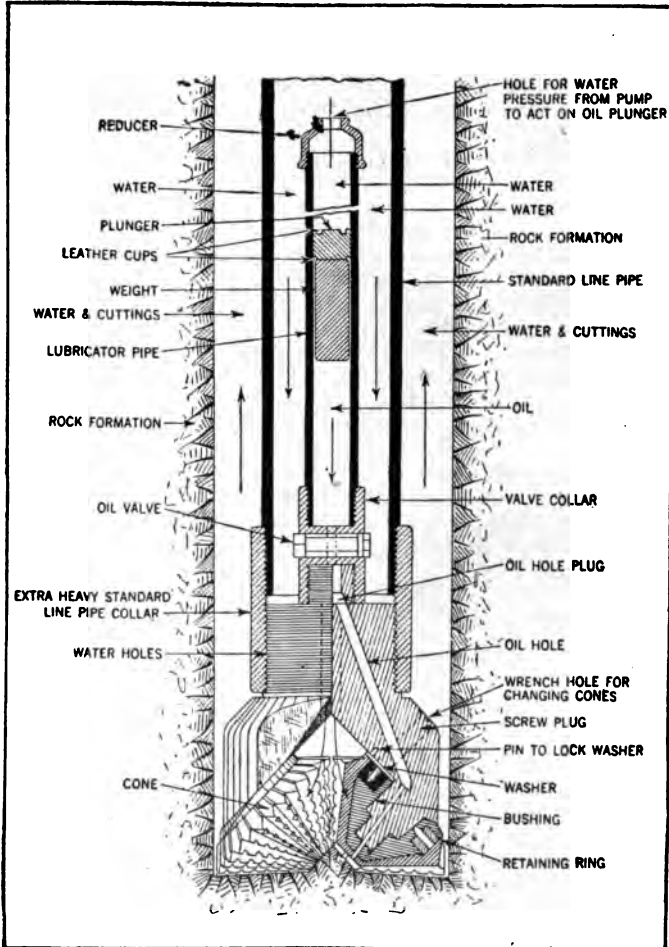

Fig. 56-G. Sharp & Hughes Cone Bit Ready for Operation.

lost all cutting power and had to be renewed. This necessitated the removal and replacement of the entire drill stem, with many (perhaps several thousand) feet of pipe, the work of many hours.

The principle of the cone bit is entirely different. The edges, or cone points of the bit, roll in a true circle like a cone bearing, and crumble or chip away the rock. The cone points, being of very hard steel, wear away slowly. Often they show but slight wear after drilling 50 ft. of rock, a few inches of which would completely dull the ordinary fishtail bit. The rolling motion allows the cutting edges on the cones to chip the rock, one edge after another.

Fig. 56-G shows the bit, drill pipe, and lubricator in the hole, ready for drilling. The lubricator pipe, about 12 ft. long, is filled with oil, which is forced down into the bit by the pressure of the circulating water on the plunger. This figure shows also that the bottom of the drill hole as formed by the operation of the bit presents a perfect seat for a water-tight joint, preventing leakage after the casing has been set. When the cone bit is introduced in a hole to which previous use of the fishtail or diamond-pointed bit has given a V-shaped bottom, it must be advanced slowly and carefully for the first foot, so that it may change that shape to suit its own form of cut.

Fig. 56-H shows the whole drilling-plant and apparatus of this system.

The proper adjustment of the weight upon the bit is the secret of good work with this drill. Experience has shown that the following weights give satisfactory results for the corresponding bits of standard sizes:

DRILLING WEIGHT ON BIT

Diameter of Bit, In.	Weight, Lb.	Diameter of Bit, In.	Weight, Lb.
2 $\frac{3}{8}$	2,870	6 $\frac{1}{2}$	7,900
2 $\frac{7}{8}$	3,480	7 $\frac{1}{8}$	8,650
3 $\frac{1}{8}$	4,700	7 $\frac{7}{8}$	9,270
4 $\frac{1}{8}$	5,310	7 $\frac{7}{8}$	9,560
4 $\frac{1}{2}$	5,910	8 $\frac{1}{2}$	10,300
5 $\frac{1}{2}$	6,670	9	11,000
5 $\frac{7}{8}$	7,140	9 $\frac{1}{8}$	12,000

For bits larger than those in the table, as much weight as practicable may be employed with little or no risk of overloading the bearings in the bit. But within the limits of the table, the weights given are probably as great as prudence would permit. For extremely hard rock, the speed, not the weight, should be increased.

The following actual working tests show the performance of the cone bit in comparison with the old fishtail:

The House No. 1 well of the Producers' Oil Co., Humble, Texas,

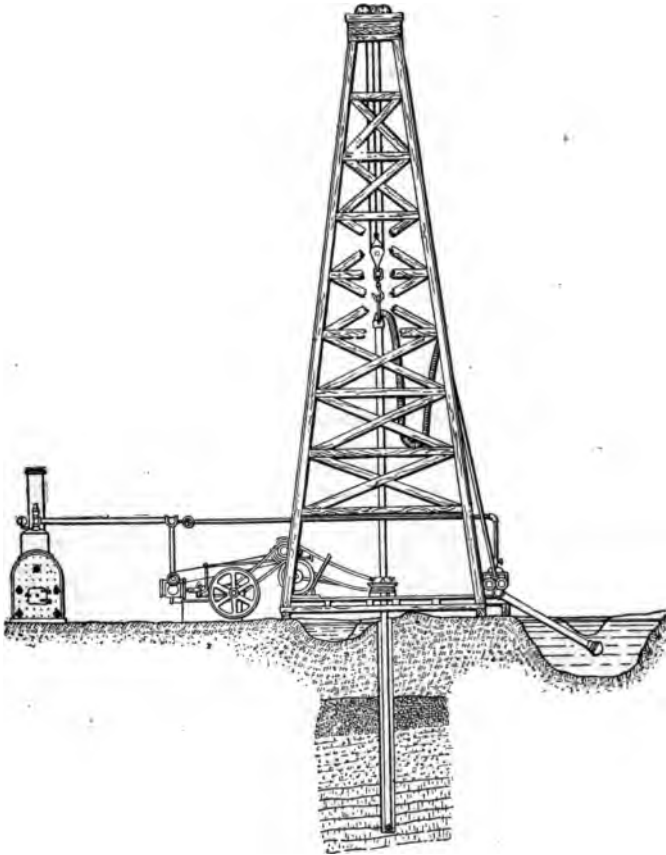

Fig. 56-H. A Complete Rotary Drilling Outfit.

struck rock at 1,819 ft., after which the fishtail bit bored 38 ft. in 19 days—an average of 2 ft. a day. The cone bit was then substituted, and bored 72 ft. in 6 days, or 12 ft. a day.

The comparative costs were as follows:

FISHTAIL

Day crew:

4 Men, \$3 per day, 19 days	\$228.00
1 Driller, \$200 per month, 19 days	120.87

Night crew:

4 Men, \$3 per day, 19 days	228.00
1 Night driller, \$5 per day, 19 days	95.00
Dressing 38 9-in. fishtail bits at \$2.25	85.50
Steam and water, 19 days, at \$10	190.00
Total cost for 38 ft. of 9-in. hole	\$953.17
Average cost per foot	\$25.08

HUGHES CONE BIT

Day crew:

4 Men, \$3 per day, 6 days	\$72.00
1 Driller, \$200 per month, 6 days	40.00

Night crew:

4 Men, \$3 per day, 6 days	72.00
1 Night driller, \$5 per day, 6 days	30.00
Steam and water, 6 days, at \$10	60.00
Rental of bit for 30 days	50.00
3 Sets of cones, at \$45	135.00
Total cost of 72 ft. of 9-in. hole	\$459.00
Average cost per foot	\$6.38

This comparison takes no account of the strain and wear upon machinery, the greater cost of superintendence per foot drilled, and the loss of time, under the old system.

While primarily designed for oil and water wells, this cone bit can be applied in drilling sump holes for mine pumps, in making air shafts, and in driving holes inclined at various angles from the vertical. Its use greatly enlarges the field of the rotary system, and the cone bit already is extensively used in California, Mexico, Trinidad, Roumania, Russia, Persia, Egypt, Japan, Borneo, and India, by presenting the great advantages of more rapid drilling through hard rock; of reaching greater depths than any other rotary apparatus can compass; of finishing a hole with smaller reduction of surface diameter than any other system permits; of the consequent requirement of fewer "strings" of casing; of less deterioration of drill pipe through strains and vibration, and of the saving of much time consumed in removing the drill pipe for sharpening or changing bits.

In the discussion of the foregoing, Mr. I. N. Knapp said: The claims made in the paper for the Sharp & Hughes cone bit are modest. I have used it with satisfactory results. It is a wonder for eating through hard, brittle rock; it will drill through iron pyrites that the fishtail bit cannot enter.

Soft ground is apt to contain conerctions that are much harder than the containing ground. We have at times in drilling with a fishtail bit thought the hole was partly in such hard material and partly in soft, thus making a difficult place to drill past in the ordinary way. By changing to a Sharp & Hughes cone bit such obstructions were easily overcome. This cone bit has greatly

widened the range of work that may now be profitably accomplished by the hydraulic rotary method of drilling.

It is not, however, adapted to drill soft or sticky ground, the old fishtail bit being better for such purposes. The fishtail bit usually scrapes its way through the material drilled, but not always. I believe at times it cuts and chips in soft friable rock. That is, the bit seems to bite into the rock, and when sufficient torsion is put on the drill stem it breaks its hold and jumps around and chips the rocks from the bottom of the hole, like a stone cutter's chisel, and then takes another hold. This condition occurs only in friable material when the bit is sharp and the feed properly controlled. The Sharp & Hughes cone bit is a most valuable tool for the rotary driller.

Comparative Costs of Rotary and Standard Cable Drilling.

In *Transactions American Institute of Mining Engineers*, 1915, Mr. M. L. Requa gives the following:

In the fall of 1910, the Nevada Petroleum Co., operating in the Coalinga field in California, determined to drill a number of wells with rotary as compared with the standard rig.

At that time, the rotary was but little known in California and its proposed introduction met with considerable criticism on the part of the operators and quiet opposition among the standard drilling crews. There were few men available who were competent to handle a rotary outfit and these few had had but little experience in California fields. Machines as then built were much inferior to those now used, being lighter in construction and of a poorer quality of material. The shells encountered at depths between 1,700 and 2,000 ft. seemed to be too hard to permit of successful drilling, and at these depths the rig was changed over to standard tools and by them completed.

Because of the heavy depreciation, the time lost in converting from rotary to standard, and the comparatively small profit, it was concluded that unless in the future there was some material improvement in rotary rigs, nothing would be gained by drilling with rotary tools upon this property. Little or no drilling has been done upon the property since that time, but in the meantime a large number of men have been trained in the use of the rotary; in fact, many standard-tool men have abandoned standard drilling and, starting in as roustabouts, have become thoroughly competent rotary operators. The improvements in the machinery have been such as to remove many of the objections and the rotary drilling of to-day is in every way superior to that of 1910.

In contrast, a well drilled recently by the Kern Trading & Oil Co., in the east side Coalinga field may be cited. The first 2,500 ft. was drilled in 24 days and it is confidently expected that

the water string will be set with a rotary at 3,400 ft.—a record obviously far beyond that made in 1910 by the Nevada Petroleum Co.

In drilling 3 holes with a standard cable rig, on the same property and to a depth of 1,955 ft., the average cost per foot was:

Materials	\$0.637
Labor	1.287
Overhead charges	0.132
Oil	0.316
Water	0.060
Depreciation	0.995
Total	\$3.417

The depreciation per hole was estimated at \$1945.91 (or \$0.995 per ft.), distributed as follows:

33 $\frac{1}{2}$ % of \$247.50, "bull band"	\$82.51
33 $\frac{1}{2}$ % of \$258.75, steel crown block pulley	86.25
60% of \$2,561.08, excess casing	1,024.40
10% of \$35.00, walking beam	3.50
20% of \$3,483.75 drill tools	696.75
25% of \$182.00, sand line	45.50
20% of \$35.00, Cokely truss rod	7.00
Total depreciation per hole	\$1,945.91

The time to drill a 1,955-ft. hole was 88.3 days.

The wells were located on bench land about two miles from the railroad, so that hauling costs were low.

The cost of drilling 10 holes, each ranging from 1,700 to 2,150 ft., and averaging 1,955 ft., with a rotary drill averaged as follows per foot of hole:

Setting up drill	\$0.186
Tearing down drill	0.037
Stores	0.270
Extra materials	0.105
Extra labor	0.022
Fuel oil	0.241
Water	0.037
Drilling labor	1.242
Casing, screw	0.271
Depreciation of rig	0.300
Depreciation of casing	0.232
Overhead charges	0.153
Depreciation on tool joints, etc.	0.145
Extra pump connections	0.012
Total	\$3.253

The average time was 60.3 days per hole of 1,955 ft., or 32.5 ft. per day. On the slowest hole the average rate was 26.3 ft. per day; on the fastest, 39.1 ft. The average time spent in rigging up was 10 days on each hole.

Cost of Rotary and Cable Drilling in California. In *Engineering and Contracting*, Dec. 11, 1912, Mr. A. T. Parsons gives the following:

There are few lines of engineering activity where there are greater initial costs, greater risks and greater variation in unit costs than in oil well drilling, and in the California fields these characteristics are, if anything, accentuated.

Well drilling methods throughout the California fields fall into three general classes, cable tools, cable tools with a circulator, and rotary tools. Drilling by the first method consists substantially of alternately raising and dropping a heavy bit, the action being similar to that of a churn drill. At intervals, usually after drilling 5 ft. of hole, the bit is pulled out of the hole and a bailer run in to remove the pulverized material.

The formations throughout the various fields are such that wells must be cased all the way down. Each size of casing is carried approximately as far as the friction on the outside will allow. As this friction increases it becomes difficult to advance the casing at all, and it is usually necessary to pull it back a short distance and then try to force it ahead. This is called "working casing" and much time is consumed in the process, and also in cleaning out the material which usually falls in from the sides of the hole while the casing is being "worked." In addition, the excessive strain on the casing from "working" it sometimes causes it to part, with serious results.

When the friction on the casing becomes so great as to make further advance inadvisable the casing is "landed," preferably on some hard stratum. Another string or succession of joints of casing, small enough to fit inside the first string, is then started in the hole and carried down by the same methods until it becomes necessary to land that string. It is not unusual for a deep well to have five or even six strings of casing in the hole by the time it is completed.

The disadvantages of the cable tools method of drilling have led many operators using this method to install a water circulating system as an adjunct. Water is pumped down the casing, and it rises on the outside of the casing to the surface. In this way it is intended to get rid of the pulverized material without bailing, and by maintaining a clearance between the casing and the sides of the hole to keep the former free from friction. When the casing is kept close to the bit the former object is usually accomplished, but as a joint of casing is about 20 ft. long, it will readily be seen that the bit must some of the time be more than 20 ft. ahead of the casing. The removal of

the pulverized material is seldom accomplished satisfactorily. Whether the casing is kept free or not depends largely upon chance. Sometimes a uniform stream of water ascends around the entire periphery of the casing, maintaining a good clearance, but more often the water follows a comparatively small opening on one side of the casing and the rest of the casing is "frozen" tight.

Just as the action of the cable tools is similar to that of a churn drill, the action of the rotary tools is similar to that of an auger. A sharp-edged piece of steel the width of the diameter of the hole, called a rotary bit, is attached to a string of pipe considerably smaller than the size of the hole. This is called the drill pipe. The drill pipe is revolved and this motion is imparted to the rotary bit which cuts the hole. A thick solution of muddy water is pumped through the drill pipe, which, rising on the outside of the casing, serves the double purpose of carrying away the pulverized material and of "walling off" porous stratifications which might otherwise cave in the hole. Casing is put in the hole all at one time, instead of joint by joint, as is usual with the other methods.

In most wells one or more water-bearing strata are encountered before the oil-bearing stratum is reached, and unless this water is shut off it will follow down along the outside of the casing into the oil-bearing stratum, forming an emulsion with the oil, rendering it unsalable until removed. The method of shutting this water off varies in particular cases, but the general idea is the same in all. After all the water sands have been passed and the casing landed on some hard stratum a thick solution of cement is pumped down through the casing and out along the outside so as to form an impervious ring around the outside of the casing and prevent the passage of any water. The cement is allowed a sufficient time to harden before drilling is resumed. This process necessitates another string of casing being used to continue drilling, as the first string is fixed and immovable. Shutting off water is usually done just above the oil-bearing stratum, and most, though not all, operators using the rotary tools continue drilling into the oil sand with the cable tools.

The initial cost for equipment is considerable. For drilling with cable tools it is somewhat as follows:

Derrick and rig irons, complete	\$1,000
Boilers	\$ 500 to \$1,000
Drilling engine	\$ 300
Cordage and drilling lines	\$ 500 to \$1,000
Bits, bailers and other tools	\$1,250 to \$2,000
Sundries	\$ 500
<i>Total</i>	say \$1,000 to \$6,000

The cost depends mainly on the depth of the well. When using a circulator about \$1,500 should be added, the main items being two pumps and probably another boiler.

Of this equipment, derrick, boiler, engine and some of the smaller stuff will be used after the well is producing. How much of the rest of the equipment will be available for use on another well depends mainly on the depth of the well and general drilling conditions. With some deep wells, where bad luck has been experienced, practically everything will be worn out and it may be necessary to buy more tools, while with some shallow wells most of the outfit can be used on several wells in succession.

Where the rotary tools are used for most of the drilling and the well is finished with the cable tools the outlay for equipment will be about as follows:

Derrick complete with rig irons	\$1,000
Boilers	1,500
Engine	300
Cordage and drilling lines	\$ 500 to \$1,000
Bits, small tools, etc.	\$1,000 to \$1,500
Pumps	750
Rotary table, swivels, etc.	1,500
Total	\$6,550 to \$7,550

As most rotary-drilled wells are in comparatively deep territory, the value of the equipment saved is usually small.

Electric power is coming into favor for pumping producing wells, the results so far indicating a saving both for labor and power. Some operators are using it for drilling also, but the extremely variable load conditions in drilling are a drawback. Up to the present time electric power has not affected drilling costs appreciably.

Where steam is used from a central plant separate boilers are, of course, unnecessary. However, the loss of steam in lines several hundred feet long, usually not insulated, is very great, and the economy of a central plant is sometimes doubtful.

Where no bad luck is experienced, the main factor determining the cost of casing, is the depth of the well. The cost per foot in wells drilled either with the cable tools or with a circulator, will vary from about \$2 for some shallow wells, to \$5 or \$6 for wells of maximum depth. Where rotary tools are used, it is seldom that as many strings of casing are needed as with the other methods in a deep well but the cost of drill pipe, about 75 cts., per ft., should be added, as this is seldom of much value after drilling one well. Cost of casing and drill pipe will probably average from \$2.50 to \$4.50 per ft.

The other main items of expense; labor, fuel and water, vary

almost directly with the actual time of drilling. In those districts where good boiler water is abundant, the latter item is inconsiderable, but many of the California fields are situated in a desert country where the scanty local supply is heavily mineralized, and good boiler water must be brought in from a distance. Under these conditions, the cost of water will vary from \$3 to \$10 a day, the cable tools using the least water and the rotary the most, the quantity also increasing somewhat with the depth of the hole.

Cost of fuel will, as a rule, vary from \$2 to \$6 a day, varying practically in the same way as cost of water. Twelve-hour shifts are the almost universal rule in the oil fields. Where the cable tools are used, two men work on a shift, and the daily cost for labor is \$22.

With a circulator the labor cost is usually the same, although sometimes a third man takes care of the boilers and the labor cost per day is \$28 to \$30. Five men are employed on a shift in using the rotary, and the labor cost is \$35 to \$40. Overhead charges, superintendence, office expense, etc., are so variable that it is difficult even to approximate. Probably from \$2 to \$5 a day for each well would cover the cost where the property is well-managed. In using the rotary, the thick clay used to "mud up" the hole must sometimes be hauled several miles, and the cost of this will average \$5 a day.

To sum up, for the daily operating cost not including casing, we have the following:

	Cable tools.	Circulator.	Rotary.
Labor	\$22	\$22-\$30	\$35-\$40
Fuel and water	\$ 5-\$10	\$ 7-\$12	\$10-\$15
Superintendence	\$ 2-\$ 5	\$ 2-\$ 5	\$ 2-\$ 5
Mud	0	0	\$5
Total	\$20-\$37	\$31-\$47	\$47-\$65

Fifty feet or even more of hole has sometimes been made with cable tools, but it is probable that 10 to 15 ft. a day is much nearer the average, particularly with the deeper wells. Whether the circulator increases actual drilling speed in the long run is still a matter of dispute. It is probable that in some formations, the increased speed of drilling is sufficient to more than compensate for the increased cost, while in other formations it is not. Where the formation is favorable and no very bad luck is experienced, the rotary tools will sometimes make 200 ft. a day, and will average 30 to 40 ft. But where harder formations are encountered, progress is much slower, and *crooked holes* are common. In very hard formation the rotary *method is confessedly a failure.*

CABLE DRILLS, AUGERS AND COST DATA 323

For wells less than 1,500 ft. deep in most formations, the entire cost of drilling with cable tools is about as follows:

Equipment, including depreciation on stuff used again.....	\$1.50-\$ 3
Casing	\$ 2-\$ 3
Labor, etc.	\$ 2-\$ 4
Total	\$5.50-\$10

Whether a circulating system would be advisable with such a well is doubtful, and very few advocates of rotary drilling would advise using that method for such a comparatively shallow hole.

For depths over 1,500 ft. the following table of drilling costs is substantially correct under ordinary conditions:

	Cable tools.	Circulator.	Rotary.
Equipment, incl. depreciation.	\$1.50-\$ 3	\$ 2-\$ 3	\$ 2-\$ 3
Casing	\$ 2-\$ 6	\$ 2-\$ 6	\$ 2-\$ 5
Labor, power, superintendence, etc.	\$ 2-\$ 4	\$ 2-\$ 4	\$1.50-\$ 3
Total	\$5.50-\$13	\$ 6-\$13	\$5.50-\$11

Distance from a railroad point will add considerably to most of the items making up the cost of drilling. Drilling in a new field is always more expensive than in a well-known field.

The figures apply where management is good and no uncommonly bad luck is experienced. Instances of the bad luck which may occur almost any time are the loss of the bit in the hole, parting of the casing, failure to cement off water, etc. There are many wells in the fields which have cost \$20 and even \$30 per ft. to drill.

Application has recently been made by Mr. J. C. Barrett and the writer for patent on a method of drilling which, it is expected, will obviate many of the difficulties of deep well drilling. A description of the method follows:

An ordinary derrick is erected and equipped and a cellar about 10 ft. square and 25 to 30 ft. deep dug below the derrick. In this cellar is placed a rotary table driven by an engine at the surface. Drilling is done with the cable tools, the drilling line passing through the swivel, and at the same time the casing is kept free and advancing by continually rotating. A tee in the swivel connects with the circulating pumps, the arrangement of the circulating system in general being the same as with the circulator except that the circulating water is either drained from the cellar to a sump and from there pumped to the surface, or else pumped directly from the cellar, an auxiliary pump being used in either case. The casing is fitted with a special saw-tooth shoe, whose teeth terminate in grooves assisting the circulation. The shoe is made with a flare so as to ream out a hole somewhat larger than the casing, insuring clearance

along the sides of the hole. Under ordinary conditions the shoe can follow within 6 or 8 ft. of the bit. When the casing is advanced sufficiently to permit of adding another joint, the swivel is unscrewed, the bit raised from the hole, a joint of casing added, the swivel and tools returned, and drilling resumed. This should ordinarily be the only time when the tools are not actually at work at the bottom of the hole. While bailing is unnecessary with this method, a sample of the formation may be obtained whenever desired with but little loss of time, by letting the bit get a little in advance of the casing, and using a bailer in the usual way. This obviates one great difficulty of rotary drilling, the impossibility of knowing what formations are being passed through.

The cost of equipment using this method will be somewhat as follows:

Derrick complete	\$1,000
Boilers	\$1,500
2 engines	\$ 600
Cordage and drilling lines	\$ 750 to \$1,000
Bits, small tools, etc.	\$1,250 to \$2,000
Sundries	\$ 500
Pumps	\$1,000
Rotary table, etc.	\$1,500
Digging cellar and timbering	\$ 200
Total	\$8,300 to \$9,300

As friction on the casing would be practically eliminated each string of casing could be carried further and there would be fewer strings of casing in the hole than when using the ordinary cable tools. It is probable that the cost of casing would range from \$2 to \$4.50 per ft. according to the depth of the hole.

Three men would be used on a shift, and it is probable that the best results would be obtained when three instead of two shifts were worked. The labor cost would be \$30 to \$45 a day. Fuel and water would be about \$15 a day, and overhead charge would be the same as with other methods. Part of the equipment would probably be serviceable for another well.

In the absence of any records as to drilling speed, the best guide is probably a comparison with the cable tools. It is generally admitted that after allowing for time lost in bailing, working casing, cleaning hole, etc., the cable tools are not actually at work at the bottom of the hole more than 6 or 8 hours out of the 24, while with the method under discussion, it should be possible to keep them working 20 or 22 hours. With this fact in view, it does not seem extravagant to claim that 30 or 40 ft. of completed hole should be averaged.

Drilling cost on a well two thousand or more ft. deep would probably be about as follows:

CABLE DRILLS, AUGERS AND COST DATA 325

Equipment, including depreciation	\$2.50-\$3
Casing	\$2-\$4
Labor, power, etc.	<u>\$1.50-\$2.50</u>
Total	\$6-\$9.50

The somewhat greater cost of installation renders this method inadvisable for shallow territory and it is probable that there would be no appreciable saving over the cable tools with wells up to 1,500 ft. in depth. There are also some localities where the very soft formation is particularly favorable to rotary drilling. With these exceptions, the method under discussion should give better results at a lower cost than any method now in use in the field.

CHAPTER VIII

CORE DRILLS

Core Drilling. There are two kinds of drills in general use to-day for obtaining cores, the diamond drill and the shot drill. In the diamond drill diamonds are set in a hollow, rotating bit. In the shot drill, chilled shot or crushed steel is employed as a cutting agent. Occasionally in soft material steel bits without shot are used.

The diamond drill will bore in any direction, whereas the shot drill cannot be used to bore holes at angles greater than 45 degrees from the vertical. On the other hand the shot drill will bore holes of such diameter that the carbon cost in a diamond drill hole of equal size would be prohibitive.

Diamond Drills. Diamond drills are used for prospecting mineral properties, and for determining the nature of bridge foundations, the character of proposed tunnel, railway and canal excavation, etc. Fig. 57 shows a diamond drill bit.

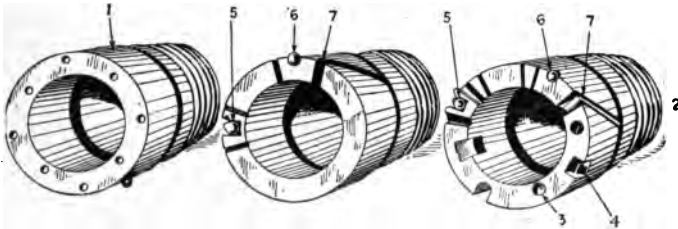

Fig. 57. Diamond Drill Bit.

The diamonds are set in such a manner that they are the only parts of the tool that come in contact with the rock. A stream of water is forced down through the interior of this bit, passing up outside of it and carrying away the material ground up by the diamonds.

The bit is a steel thimble having two rows of diamonds (bortz or carbons) embedded therein, so that the edges of those in one row project from its face and outer periphery, while the edges of

those in the other row project from the face and inner periphery. The diamonds of both rows thus operate to cut the path of the drill in its forward progress, while the projections from the outer and inner periphery of the tool enlarge slightly the cavity around it permitting free passage of the water and cuttings.

The bit is screwed to the core-barrel or spirally grooved guide, and this to the drill rods, which are made of heavy lap-weld wrought iron tubing or of seamless steel tubes, which are added, section after section, as the hole deepens. The bit is rotated by hand, steam, air or electric power. When the drill rods are rotated and fed forward, the bit passes into the rock, cutting an annular channel. The core-barrel, passing down, keeps the core of rock intact until the rods are withdrawn, when the "core-lifter" breaks the core at the bottom of the hole and securely wedges it in the core-barrel, so that it is lifted with the drill rods.

At the upper end of the drill rods is a water swivel, with connection with the steam pump. A constant stream of water is forced down through the hollow drill rods, keeping the bit cool and the hole clear of sediment, the sediment being forced by the water up around the outside of the rods to the surface.

When the core is not required, the perforated or solid bit may be used, the detritus being washed out by the water, as when boring with the annular bit.

When diamond drilling was first introduced into this country it was predicted that it would be used, to the exclusion of other methods, for drilling blast holes, and in fact diamond drills were used on the Sutro tunnel for a while, and in sinking one or two shafts by the "long hole" method, which involved drilling holes several hundred feet deep, filling them with sand, then removing the sand for about 8 ft., charging with powder, firing, and so on. The development of machine drills using steel bits and the steady rise in price of carbons have together shown these early predictions to have been erroneous.

Sizes of Cores. The sizes of holes and cores are as follows:

Hole, diam. in in.	1¼	1½	1¾	1⅞	2	2¼	2½	2¾	3¼
Core, diam. in in.	¾	1	1¼	1½	1¾	1⅞	2	2¼	2½

It will be found economical to use a light machine for small or shallow holes and a heavy machine for deep drilling. On work of large extent it will pay to have machines of at least two sizes, one for light and the other for deep drilling.

When boring in hard coal and rock up to 500 to 600 ft. in depth, it is best to use a 1¾ or 1⅞-in. bit, as the rate of progress is very much faster with a small bit than with a large one. On the other hand a 2¾ to 3¼-in. bit can be profitably employed *when prospecting* for bituminous coal or soft ores.

Diamonds. Two kinds of diamonds are used in setting bits for diamond drill work: carbons and bortz. The carbon is found in opaque nodules of irregular shapes, black on the outside and of various shades of gray when broken open. It has no cleavage plane, differing in this respect from the brilliant, and thus is especially fitted for diamond drill work in hard rock, the diamond simply wearing away gradually without splitting or cleaving. The bortz is a semi-transparent diamond, of similar appearance to the rough brilliant, but of different crystallization. It is usually nearly spherical in shape, with cleavage planes, and is of moderate size. Carbons are found in Brazil and South Africa.

For hard rock (harder than limestone) bits for diamond drills are set up with carbons only; for medium rock, half carbon and half bortz; for soft rock, occasionally with all bortz. Hard rock will shatter bortz.

Certain classes of soft rock can be cut to advantage with saw-tooth bits of hardened steel, thus saving largely in first cost of outfit. This is particularly economical in holes of large diameter. The shot method, however, is applicable only to rock of nearly uniform texture, without seams or crevices and of no great hardness, and for almost vertical holes only.

Carbons vary greatly in quality, and only experience can enable one to judge them. The stones should be as compact in form as possible, for thin edges and irregularities in their shape make good setting difficult and the stones will wear away rapidly until well rounded up in using. "Natural," or unbroken stones, are the best shapes, but it is safer to select split stones of cubical form, as their quality can be determined by an inspection of the broken surfaces. Porous and crystalline structures should be avoided. Broken stones of compact structure and in appearance like fine broken steel of gray or greenish color are best. Of natural stones select those which have polished surfaces and seem compact in structure. Carbons having straight edges with sides forming an obtuse angle of 95 degrees to 140 degrees are the most durable. Those having a cokey structure, or thin sharp edges should be rejected. The cleavage should be tested with a pair of hand pincers. Good carbon will stand heavy pressure but will break under a blow; hence care must be used in running through broken rock formations.

Price of Diamonds. Previous to 1870 carbons were practically worthless. A few years later, when they were used for diamond drilling, the price rose to \$10 per carat. In 1873 the price of carbons per carat was \$8 to \$12. I am indebted to the Standard Diamond Drill Co., of Chicago, the Yawger-Sexon Co., of New York, and Bernard Bandler & Sons, of New York, for the follow-

ing information as to the average cost of carbons per carat from 1895 to 1913.

PRICE OF CARBONS PER CARAT

Year.	Standard.	Y. S.	Bandler.	Albert E. Hall.*
1895		\$18.50		\$15
1896	\$36	28.00		20-22
1897	50	35.50		35-36
1898	60	35.50		35-36
1899	55	36.00		70
1900	50	51.50		70
1901	45	48.50		36-60
1902	50	47.00	\$48	..
1903	75		55	50
1904	75		55	..
1905	75		60	..
1906	75		70	78
1907	75		80	..
1908	75		80	80-95
1909	75		75	80-95
1910	75		80	40-65
1911	75		80	..
1912	75		80	..
1913	75		80	..

* School of Mines Quarterly, Columbia University.

It will be noted that these firms do not agree very closely. The American Diamond Drill Co., of New York, quoted \$52 per carat for best selected carbons and \$16 per carat for best selected bortz in November, 1902, and in January, 1914, they informed me that the prices per carat were as follows:

Best selected carbons: 1 carat, \$50; 1¼, \$55; 1½, \$60; 1¾, \$65.

Best selected bortz: 1 carat, \$15; 1½ to 1¾, \$17.50.

The larger the diamond the higher the price per carat.

There is no import duty on miner's diamonds or carbons into the United States. Canada or Mexico, but there is a 10% duty on bortz imported to the United States and none to Mexico and Canada.

Carbons Required. This depends upon the hardness of the rock and whether the drill is operated during the day, or both day and night. If the drill is to be worked only in the daytime, and the man who operates the machine is also to set the diamonds, then but one set with about two extra diamonds in reserve will suffice; but if the drill is to be worked both day and night, two sets of diamonds in medium rock, and three sets in very hard rock, will be required. From 6 to 8 carbons are usually set in a bit.

The size of carbons generally used ranges from one to four carats, according to the size of the bit. Most manufacturers state that it is economical to use the largest size carbon that can be set in a bit. Mr. W. M. Sturgis, of Scranton, Pa., says (*Engineering & Mining Journal*, V. 29, p. 137) that a 1 to 1½

carat diamond is just as good as a larger stone, and that for small bits (1½ to 2-in.) a ⅝ to ⅞ carat stone lasts nearly as long, does the work as fast, and is easier to set. Smaller stones are not economical because after a carbon has worn down to about ½ carat it cannot be reset.

Notes on Diamond Setting. The blank bit is laid out for placing four stones on the outside cutting edges and four on the inside. (Fig. 57, No. 1.) The four outside stones are placed in pairs, on lines at right angles; the lines joining the two pairs of inside stones bisect the angles of these lines. Laid out in this manner and carefully set, the bit will be well balanced and run smoothly and true.

After selecting a stone for a certain position, a hole is drilled with a twist drill smaller than the stone; then by use of the small chisels and calking tools, the metal of the bit is chipped away and calked back to conform as closely as possible to the size and shape of the stone (Fig. 57, Nos. 3 and 4). Especial care should be taken to see that the stone is seated perfectly and that it is up to gage on the face of the bit as well as on the side.

The proper amount of clearance for the stones depends upon the character of the rock. For very hard rocks which hold together well and are not apt to clog, a clearance of one-sixty-fourth of an inch on each stone, making one-thirty-second of an inch on the full diameter, will be found sufficient; but in drilling soft rock one-thirty-second of an inch and frequently more is necessary.

After the cavity has been properly formed to receive the stone, it is put into place, and by means of the calking tools and punches the metal of the bit is drawn back around the stone, fastening it firmly. Two heavy chisel cuts are usually made a short distance from the stone across the face of the bit and these are used as starting points from which to draw the metal over. In calking the metal over, be careful not to throw the stone out of position, either by crowding it down or to one side, or forcing it too high on the cutting face. A little time exercised on this point when first starting is well spent. Be careful not to strike the diamond with the hammer or the calking tool; the diamond will stand a very heavy, steady *pressure*, but will be shattered by a very slight *blow*. Calk the metal in evenly all around the diamond; i. e., do not calk the metal closely upon one side and then on the other, but work carefully clear around the stone, bringing the metal together in a body as closely as possible. If the stone is so irregular that in order to get it into place *in the bit it is necessary to chip away a large amount of metal, so that there is not sufficient metal to fit in when calked back,* a small piece of copper or horseshoe nail can be used for filling

in and thus leave enough metal to permit of calking firmly into place.

When setting the inside stones, it is well to take a small piece of tin or sheet iron, bent properly to cover half of the face of the bit, and place it over the stones that have been set opposite the stone being worked on; this will often prevent the breakage of a stone through the slipping of a hammer or tool.

After the diamonds are all set, water grooves (Fig. 57, No. 7) should be cut across the face of the bit and down the inside and outside to the counterbore and the shoulder. Be careful to make them ample, so that the drill cuttings may be easily carried away by the flow of water. If the water grooves are not made large enough, the metal of the bit is worn away from the diamonds, and the settings become loose and unsafe before they should.

The bit should be carefully examined each time the rods are pulled and when the metal shows sign of wear it should be carefully calked back around the diamonds. This examination sometimes shows that the diamonds do not cover the cutting face properly; in such cases it is best to set in a small stone to reinforce the setting for the time being, and when the diamonds are cut out and reset, be careful to see that they cover.

To cut the stone out after the bit has become worn so that the settings are unsafe, take a hacksaw or file and cut across the face of the bit close to the stone and then chip the metal away.

Diamond Consumption. The cost of carbons and bortz consumed in boring 39 underground holes at the Burra Burra and London mines, Ducktown, Tenn., is shown below.* The holes were drilled in 1907 with two Sullivan machines of the "S" type, and all but three holes, aggregating 284 ft., were horizontal across the formation. The core was $1\frac{5}{16}$ in. diameter and the holes $1\frac{1}{2}$ in. diameter.

The highest cost per foot was \$3.66, in a horizontal hole started in the footwall and drilled to a depth of only 8 ft., consuming $1-6\frac{1}{64}$ k. of \$15 bortz. Excepting this hole, which penetrated very hard blue quartz, the highest cost for a hole drilled with bortz was \$0.83 per ft. This hole was drilled in the footwall of the Burra Burra mine to a depth of 52 ft., 37 ft. being in hard silicious vein material and 15 ft. in country rock; $2-5\frac{7}{64}$ k. of \$15 bortz were consumed in boring it.

The lowest cost per foot was \$0.032, and was obtained from a horizontal hole bored to a depth of 190 ft. in the hanging wall of the Burra Burra mine. This hole penetrated 10 ft. of vein material at its mouth, and the remainder cut through soft mica schist so thinly foliated that there were but few pieces of core

* Reprinted from an article by Benj. H. Case in *Engineering and Mining Journal* for August 21, 1909, in *Eng. & Con.*, Sept. 8, 1909.

recovered more than $\frac{1}{2}$ in. thick. The stone consumption was only $3\frac{3}{4}$ k. of \$10 bortz.

Cost Using Carbons.—The highest cost of a hole drilled with carbons was \$1.15 per ft. This hole was drilled in the footwall of the London mine to a depth of 92 ft., and penetrated 22 ft. of vein and 70 ft. of country rock. The loss in stones was $1\frac{1}{4}$ k. at \$85. The lowest cost with carbons was \$0.072 per ft., from a hole in the footwall of the London mine which penetrated 30 ft. of vein and 44 ft. of country rock. The stone consumption for the hole was $\frac{1}{6}$ k., at \$85.

Cost Using Bortz.—The stone consumption given in Table XXXVIII does not take into account the loss from scrap bortz in the drilling. This loss was: $4.5\frac{5}{64}$ k. at \$15, \$73.59; $5.5\frac{7}{64}$ k. at \$10, \$58.90; total, $10.5\frac{1}{64}$ k., \$132.49. The above amount distributed to the 2,948 ft. drilled wholly and in part with bortz gives an additional cost of about $4\frac{1}{2}$ ct. per ft. for holes drilled with these stones. There was no loss in carbon scrap, a loss occurring usually when the stones have worn too small to be utilized in a bit.

Summarizing and leaving out of the calculations those holes where both bortz and carbons were used, the cost with bortz, for 2,781 ft. drilled, was \$0.247. The additional loss for scrap, which amounted to \$0.045 per ft., brings the cost up to \$0.292 per ft. This is much less than the carbon cost of \$0.509 given in the table.

Adaptability of Each Stone.—Bortz may be profitably used in drilling soft ground, but in hard material they are useless, as the stones, all of which contain flaws, will shatter when encountering hard rock. It is doubtful whether bortz could have been used with cheaper results in drilling the 840 ft. that were drilled with carbons. Some of this ground they would not have cut without great waste. Where part carbon and part bortz was used, the carbons were substituted for the bortz when it was found that the bortz would not stand the work.

In some formations, where there are strata or zones of varying degrees of hardness, bits set with carbons might alternately be used with those set with bortz, but the bits could not very well be set in advance owing to the varying gage of the hole.

TABLE XXXVIII. ANALYSIS OF STONE CONSUMPTION

Feet drilled.		Stones		Total Cost per		
Total.	Vein.	Country.	Consumed.	Cost per carat.	cost.	foot.
1437	411	1026	$255\frac{5}{64}$ k.	Bortz at \$10	\$258.60	\$.180
564	65	481	$16\frac{1}{64}$ k.	{ Bortz, $7\frac{1}{64}$ at \$10	72.03	
				{ Bortz, $9\frac{1}{64}$ at \$15	135.94	.380
798	226	572	$144\frac{5}{64}$ k.	{ Bortz at \$15	220.55	.276
167	90	77	$83\frac{1}{64}$ k.	{ Bortz, $6\frac{1}{64}$ at \$15	99.84	
				{ Carbons, $1\frac{5}{64}$ at \$85	154.06	.922
<u>840</u>	<u>228</u>	<u>612</u>	<u>$5\frac{1}{64}$ k.</u>	Carbons at \$85	427.66	.609
3788	1020	2768	$70.25\frac{1}{64}$ k.	Totals and averages	\$1368.68	361

The foregoing costs are higher than the average, which is generally around 25 ct. per ft. for carbons at \$60 to \$80.

The following detailed cost of work in New York is abstracted from the catalog of the American Diamond Drill Co., and shows what cost of carbons should be under average conditions:

Mr. C. H. Cady sends (1896) the following statement of the work of the No. 3 Improved Drill at Mineville, New York. In gneiss 1,250 ft. was bored in 91 days, at a rate of 1.36 ft. per hr., using 18.6 carats of carbons or 1.486 carats per 100 ft., and 45 lb. of coal per ft. drilled.

	Cost per ft.
Carbons, at \$14 per carat	\$.208
Labor, including contractors' time	1.020
Coal, at \$5.10 per ton102
Bit blanks067
Moving and setting up062
Repairs061
Steam and water connections110
Supplies034
Total cost per foot	\$1.664

A record of extremely low cost in carbon consumption is given by Mr. J. F. Bennett in *Mine & Quarry* (reprinted in part in *Engineering and Contracting*, April 29, 1908) and is partially reprinted below. This work was in Mexico, in formation which made diamond drilling an economic necessity. The ore, a silver lead, occurring as sulphide, oxide, and carbonate, is deposited irregularly in pockets of varying dimensions, usually connected by pipes or stringers through the country rock of limestone.

The company at present employs 17 diamond drills, and performs about 12,000 ft. of core drilling per month. The drill-holes are run at right angles to the drifts, about 16.4 ft. apart, to an average depth of about 199 ft. Horizontal holes predominate, but there is also considerable angle work.

Four of the machines are of the Sullivan "R" type, which have a capacity of 300 ft. in depth and remove a $1\frac{5}{16}$ -in. core. These drills are fitted with improved screw feed with friction escapement, and are operated by electric motors on a 250-volt direct current, which is stepped down from the 6,600 volt alternating current transmitted from the power plant at Mapimi. The remaining drills are of an early Swedish type. They are run by small electric motors, but the diamond bit is advanced by hand.

The average cost of drilling for the year 1906 for all the drills was about 50 ct. per ft. Two Mexicans are employed on each drill, a runner at \$1.58 and a helper at 99 ct. They average about 16.4 ft. per 10-hr. shift with the Swedish drills and 23 ft. with the Sullivan "R" machines. The cost of labor

only, for the Swedish drills is thus 15 ct. per ft., and 11 ct. for the Sullivan drills.

Owing to the soft, even character of the rock, it is possible to use small carbon, weighing about one carat, of a grade costing \$40 gold per carat. The following table shows the average cost of the company's drilling work for the first five months of 1907. All figures are in U. S. currency. Fig. 58 shows one of the Sullivan drills in operation.

	Labor cost, including salaries of foreman, setter, etc., per ft.	Diamonds, cost per ft. Diamonds at \$40 per karat.	Total cost, including power, etc., per ft.	Average drilled per month, per machine, ft.
January	\$.24	\$.027	\$.42	951
February22	.072	.43	872
March24	.023	.41	820
April22	.067	.40	938
May28	.045	.46	886
Average for 5 mo.	\$.24	\$.047	\$.42	893.4

Water Required. In boring a 2-in. hole where the progress is about 10 ft. per 10-hr. shift, from 100 to 125 gal. of water are required to wash out the sludge formed in drilling, provided the water is used but once. In cases where the water is expensive it is customary to collect the return water in a settling tank and use it over and over; and, unless a large amount of water escapes through crevices, 30 or 40 gal. per shift will be consumed by evaporation and leakage.

The Use of Air Instead of Water. In drilling fissured rock trouble is frequently experienced because of the quantity of water required. Mr. Ralph Wilcox (*Engineering and Contracting*, Nov. 12, 1913) substituted air for water at the Mines of the Miami Copper Co., Miami, Arizona, and found no difficulty in drilling to a depth of 300 ft. the greatest depth required on this work. In fact, he states that the difficulties of operating in friable copper-bearing schist were decreased 75%. The amount of air used ranged from 23 to 82 cu. ft. of air per min. with an average of 47 cu. ft. at 75 lb. pressure. The success of this experiment shows the possibility of using diamond drills in regions where water is very scarce.

Price of Diamond Drills. A hand power drill that can be used to bore a $1\frac{3}{8}$ in. hole (giving a $1\frac{5}{16}$ in. core) up to a depth of 350 ft. in rock will cost about \$550 to \$650 f.o.b. Chicago or New York. This price included all necessary equipment except the carbons, of which 6 stones, weighing 6 carats and costing



Fig. 58. Diamond Drill in Operation.

about \$450 are required. This machine equipped to drive 400 ft. will cost about \$100 extra. The same machine rigged to bore a 2 $\frac{5}{8}$ -in. hole, 250 ft. deep in prospecting for coal, etc., will cost about \$750, and will require 8 borts, weighing 12 carats and costing about \$180. If it is desired to run this drill by horse power, it will cost \$90 extra.

A steam power machine that can be used to drive a 1 $\frac{3}{8}$ -in. hole, 800 ft. deep, will weigh about 9,000 to 10,000 lb. and cost complete with 8 h.p. boiler, engine on wheels, etc., except diamonds, \$1,900 to \$2,500. It will require 6 carbons, weighing 9

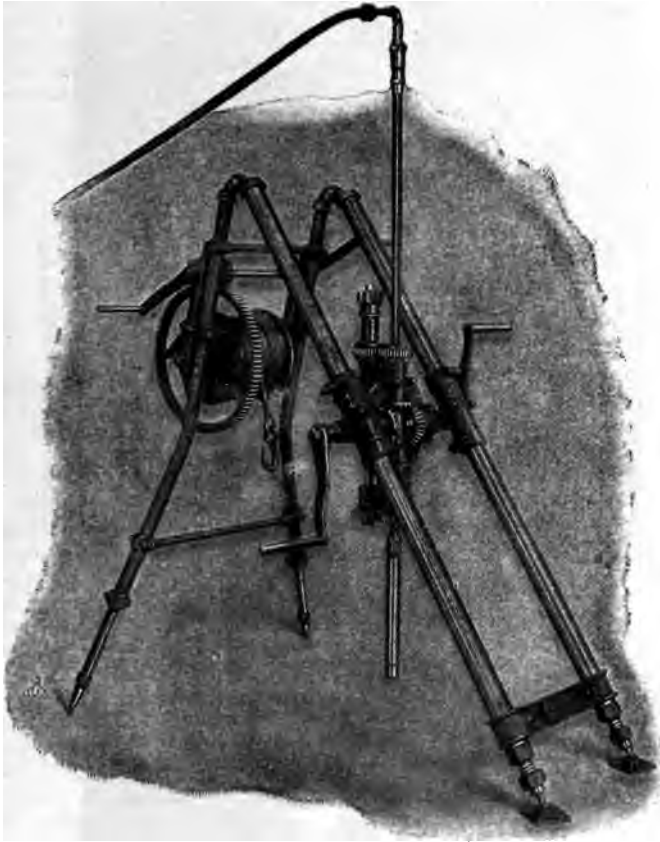

Fig. 59. Sullivan Class M Hand Power Diamond Drill.

carats or 8 bortz weighing 12 carats. This drill equipped with an 8 h.p. motor costs about \$2,400. The entire outfit ready to work, will cost from \$2,500 to \$4,000.

A steam power plant for boring a 2-in. hole 3,000 ft. in rock or a 2 $\frac{1}{8}$ -in. hole 2,000 ft. in prospect work, requires 20 h.p., weighs 26,000 lb. complete, and costs \$5,000 to \$5,400 complete *except for diamonds*. It will require 8 carbons weighing 20 carats in rock and 8 carbons weighing 16 carats in surface work. A steam outfit for drilling a 2 $\frac{1}{8}$ -in. hole, 4,000 ft. will require

25 h.p., weigh 28,000 lb., and cost about \$7,000 complete except for diamonds, and will require 8 stones weighing 20 carats.

In the work of making test borings for Catskill Reservoirs, the following outfit was used. The drill and pump were mounted on a wagon which was easily moved.

1 "Badger" diamond drill	\$ 540
1 "Blake" duplex pump	59
1 Double-reach lumber wagon	61
1 8 hp. boiler	287
1 large pipe derrick, 2 ½-in. pipe	15
1 10-in. gin-block	10
1 2 ½-in. drive head	9
2 2 ½-in. drive weights, 1 hollow, 1 square, at \$8	16
100 ft. 2 ½-in. extra heavy flush joint casing at 81ct.	81
100 ft. 1-in. wash pipe at 11ct.	11
100 ft. "E" drill rods at 65ct.	65
1 canvas wind-shield	10
50 ft. 1-in. 3-ply hose at 13ct.	6
1 hoisting water swivel	10
1 pair of clip tongs	1
2 "Stilson" wrenches, one 18-in. and one 24-in.	3
1 monkey wrench	1
1 crowbar and 1 large axe	2
1 shovel	1
2 galvanized iron pails at 25ct. and 1 hammer	1
1 battery and wire	2
1 safety clamp	20
1 hoisting plug	2
1 10-ft. "A" core barrel	14
1 15-ft. "A" core barrel	7
6 blank "A" bits at \$1.25	7
8 black diamonds — 12 karats at \$45	540
1 hydraulic bit	4
2 chisel bits	3
Total	\$1,788

The above is abstracted from a paper by J. S. Langthorn read before the Brooklyn Engineers' Club, Jan., 1909.

Derricks. For general use a tripod derrick is customary. For holes 1,000 ft. or more in depth, substantial derricks are necessary. These are ordinarily of wood. Steel derricks will cost about as follows:

30 ft. high	\$125
63 ft. high	575
3 legged derrick 63 ft. high	425

The weight ranges from 1,500 lb. for the 30-ft. derrick to 5,400 lb. for the 63-ft. derrick.

Cost of Moving and Setting Up a Diamond Drilling Outfit. The following cost of dismantling, moving and re-erecting a diamond drill in prospect work is furnished by Mr. Albert E. Hall (*Engineering and Contracting*, Apr. 24, 1912). The shed was built for winter service and was fairly substantial.

Tearing down old shed, ½ day.		
1 Setter at \$5.00	\$2.50	
2 Runners at \$3.50	3.50	
2 Firemen at \$2.75	2.75	
2 Coremen at \$2.75	2.75	\$11.50

Moving to new location, 1 day.		
The crew at \$17.50	\$17.50	
2 Core checkers at \$2.75	5.50	
2 horses at \$.75	1.50	
1 Driver at \$2.50	2.50	
1 Helper at \$2.50	2.50	\$29.50
Erecting new shed and machine, 2½ days.		
Lumber, nails, tar paper, etc.	\$40.00	
The crew at \$17.50	40.83	
2 Core checkers at \$2.75	12.80	\$93.63
Total		\$134.63

Instructions for Operating Diamond Drills. Fig. 60 shows the usual arrangement of mounting a drill for surface prospect work. If there is not a plentiful water supply at hand, a sump should be dug or barrels sunk in the ground so that the water from the drill hole will settle therein and may be used repeatedly.

After the machinery is properly set up, the drill spindle should be aligned — usually by loosening a bolt on the yoke, thus permitting the entire swivel-head to be turned to the proper point. A drill rod is then passed through the hollow spindle and secured to the chuck. The water swivel or joint is screwed on the top of the rod and is connected by a hose to the pump. A short core barrel with core lifter and diamond bit is screwed to the lower end of the rod. The pump is then started and after water shows coming through the bit, steam is turned on. The speed should be slow until the hole is “collared.” After a short core barrel has made three or four “runs,” a long one is placed on the rod. Before raising the rods for removing the core, water should be run into the hole after drilling has ceased until the sludge is well flushed out. Driving pipe and spudding are performed in a manner similar to cable drilling, although the bit used in cutting through boulders, loose rock and soft material is somewhat different with the diamond drill.

Fig. 61A and B illustrate the commonly used chopping bits, single and double bladed. These are fastened on the end of the drill rods and churned up and down. Fig. 61C illustrates the lipped bit, and Fig. 61D, the auger, which are used in drilling through hard pan. Fig. 61E illustrates an auger which is effective in clay. The pod bit, Fig. 61F is used in loose sand and heavy material, and the double-spiraled auger, Fig. 61G is used in nests of gravel or small boulders.

Divergence of Holes from Line. The drift of bore holes from a straight line is a very serious matter. It is due to several causes, among which are: (1) soft formations and the neglect to extend casing; (2) boring a large hole and following the core-barrel with small rods; (3) giving the diamond too much clearance beyond the metal of the bit; (4) using a worn bit or

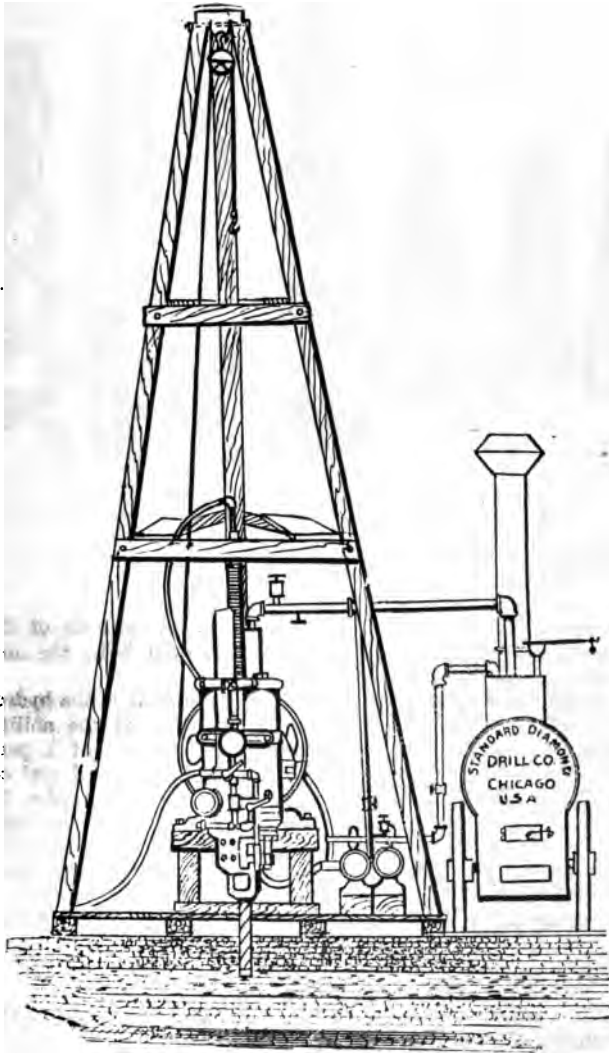

Fig. 60. Diamond Drilling Rig.

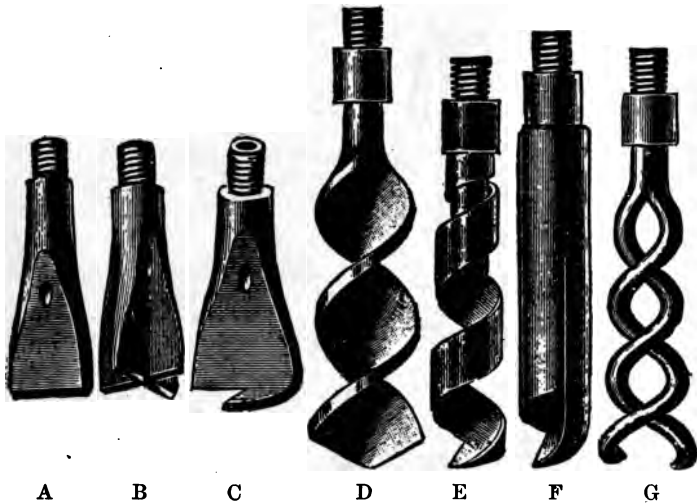

Fig. 61. Spudding Bits and Augers Used in Diamond Drilling.

core-barrel too long a time; (5) the magnetizing of long drill rods by friction in the hole; and (6) the effect of hard strata lying at an acute angle with the hole.

Surveying the Bore-Hole. There are several methods of determining the direction and slope of the drill hole, the following being the ones usually employed.

Hydrofluoric Acid Method. The simplest method is the hydrofluoric acid test for inclination which is based on the ability of this acid to etch glass. The solution, composed of 1 part hydrofluoric acid to 9 parts water, is placed in a small vial or tube. This tube is placed in a steel shell, bored to receive it, and lowered into the hole where it is allowed to remain about half an hour. A good method of reading the angle is by attaching the bottle to a pivot which operates a needle over the graduated scale of a protractor. A correction is necessary on account of the capillary attraction. On the Catskill Aqueduct work, a minus reading varying from 4° for a reading of $26^{\circ} 24'$, to 8° for a reading of $52^{\circ} 05'$, was used. The objection to this method is that one false reading affects all the deeper readings.

Mr. J. Parke Channing gives the following information on the hydrofluoric acid method as used in Michigan:

A blank tube was put in the combined bit and core shell from the top end until the lower end rested on the spring. Holding this in position, it was laid beside the core barrel so that the

length of thread was allowed for, and a file mark made on the core barrel just even with the top of the glass stopper. A dry wooden plug was made to fit the core barrel and driven in till it just cleared a point corresponding to the file mark. The core barrel was now clamped in a vise in a nearly vertical position.

The stopper of the tube was held in a tin spoon with a little paraffine over a candle flame, and the upper end of the tube warmed. An inch of 20% hydrofluoric acid was carefully poured into the tube, then an inch of water, and the stopper taken from the melted spoon of wax, smartly rapped to throw off any excess of paraffine, and quickly put in the tube. The acid immediately heated up the tube, but no ill effects resulted from this. Wrapping a thread or two of lamp-wicking around the neck of the tube, it was put in the core shell and, still holding it in an upright position, the upper end was introduced into the core barrel and the thread between the shell and the barrel screwed up. Carrying the barrel in an upright position it was put down the hole, no special pains being taken in lowering down the rods, save to touch the bottom of the hole carefully.

Several experiments were made as to the time necessary to leave the tube in the hole, and showed that two hours was as good as 24. One hour did not give very good results. The churning up of the acid in going down the hole did not in the least affect the test, and the result was generally clear.

When the tube came out of the hole it was tried before removing the stopper making the liquid coincide with the line of crystals. The stopper was then removed, the crystals cleaned out, fresh water put in, and the angle again tried, using as a guide that portion of the glass which had been etched by the acid.

In order to see whether the rods would really turn when bent at angles as shown by the above record, Mr. Channing connected together 50 ft. of Sullivan "E" rods made of double thick pipe whose external diameter is 1.13 in. Curving this so that the depth of the arc was 6 ft., he had no difficulty in "tonging" the rods with a pipe wrench. This curvature was much greater than that found in the holes.

There is one point, however, which Mr. Channing failed to determine, and that is the amount of lateral deviation of the hole, if any. If the country had been totally free from local attraction, there would have been no difficulty in sending down in the core shell a small compass mounted on a universal bearing, with a tripping arrangement to set it when the bottom of the hole was reached and the needle quiet. The dip of the hole was tested every 100 ft., and thus a fair idea was obtained of the work.

On some of the deep holes the point was 50 ft. higher up and 50 ft. further away from the collar of the hole than if it had gone straight.

In looking about to discover why the holes flattened, Mr. Channing remembered that about the last part of hole No. 2 he put in a new core barrel. These core barrels when new are $1\frac{1}{2}$ in. in diameter, but after use wear down to $1\frac{1}{4}$ in. at the upper end. The bits used were $1\frac{17}{16}$ in. and the clearance of the stone $\frac{3}{64}$ in. on each side, so that the gage of a new bit was $1\frac{17}{32} + \frac{3}{64} = 1\frac{19}{16}$ in. It is quite evident that with an old core barrel $1\frac{1}{2}$ in. diameter at its upper end and a bit $1\frac{19}{16}$ in. at its lower end, and this bit constantly kept up to gage, we have a 10-ft. tapering boring tool. The weight of the rods and their pressure produce a tendency for the upper end of this tool to rest on the bottom of the hole, and thus in a distance of 10 ft. the line of tool is $\frac{5}{32}$ in. out from the line of the hole in which the tool rests.

Electric Light Method. A second method is by means of the surveying instrument (Fig. 62) which is now exclusively used on the Rand, was invented by Mr. Oehman and improved upon by Mr. A. Payne-Gallwey. The instrument is an electric light photographic apparatus and consists essentially of a gun-metal tube in two halves (*a*) connected by a coupling (*o*). In the lower half of the gun-metal tube are placed a magnetic needle (*b*) and a plumb-bob (*c*), each independent of the other and each swung over a gimbal (*d*). Above the needle and plumb-bob, respectively, is fixed a small electric lamp (*e*) and all are held in position and pressed against an insulated brass rod (*f*) in the center of the coupling, by a spiral spring (*g*) attached to the bottom screwed plug (*h*). In the side of the tube, a series of small screws (*i*) are placed in a straight line parallel to the side, their ends projecting inside the tube about $\frac{1}{16}$ in. The cylindrical cases carrying the lamps and those carrying the needle and plumb-bob have a slot down the side, the projecting screws acting as guides for the slotted cases to slide into and keep them in position.

The top half of the tube contains a dry battery (*k*) and a clock (*j*) which has a spiral spring (*l*) attached to it. The spring presses against the top end-piece (*m*) of the tube so that when the two halves of the tube are screwed together everything inside is held rigidly together and contact assured by means of the spiral springs at top and bottom. To the top end-piece a ball-bearing swivel (*n*) is attached in order to lower the instrument on a wire, if necessary. The cases (*p*) which carry the *marine compass* attachments for the magnetic needle and the *plumb-bob* are made of vulcanite, for insulating purposes, the

compass attachments being made of brass, the outer ring of which is held in position by two brass screws on which the ring swings. On the face of each gimbal is a fixed pin point and round the edge is a recessed ring which holds the disc of sensitized photographic paper in place, the pin points holding them in position. The plumb-bob is made of gold attached to a fine silk thread swung from the center of a thin disc of plate glass (q) which fits into a recess in the top of the vulcanite case. Both the magnetic needle and the plumb-bob swing immediately above (almost touching) the sensitized paper.

The watch has an extra wheel (r) to which is attached a copper projection (s) which at a certain set time makes connection with a copper spring (t) attached to the frame of the watch and completes an electric circuit lighting up the lamps above the plumb-bob and the needle and photographing a sharp shadow of each on the sensitized paper. When the two photographs are developed, the dip and direction can be read off by making the pin pricks coincide.

The Azi-clinometer. A third method is that used in the Mineville district of New York, which was described by Guy C. Stoltz in the *Engineering and Mining Journal* (see also *Engineering and Contracting*, Apr. 19, 1911). The instrument used is called the azi-clinometer which, as the name implies, is for determining the azimuth and inclination of the hole. The azimuth can be read from a magnetic needle and the inclination on a clinometer. The instruments are mounted in a brass cylinder (Fig. 63), 1 ft. long and $1\frac{3}{8}$ in. inside diameter, on a vertical axis which at both ends rests in jeweled bearings, in the cylinder partitions. A portion of each side of the cylinder is cut away to enable reading of the instruments. At the base of the cylinder is a brass bumper and lowering weight which is free to slide in the cylinder and which is pressed upon by a coil spring. As the instrument is lowered in the drill hole, the bumper takes up any shock that might result in the instrument striking the bottom severely.

Preparatory to taking readings with the azi-clinometer, a piece of stick candy or alum, or any substance readily soluble in water, is inserted in a spring framework mechanism operating on the clinometer pointer and above the graduated arc, while another piece of the soluble substance is placed in a similar housing under the magnetic needle. The candy upon melting in these housings disengages the springs and levers, one system of which locks on the clinometer pointer, while the other acts upon the magnetic needle of the compass box.

The instrument is then screwed into the base of a brass containing case, 5 ft. long and $1\frac{3}{8}$ in. internal diameter, which has

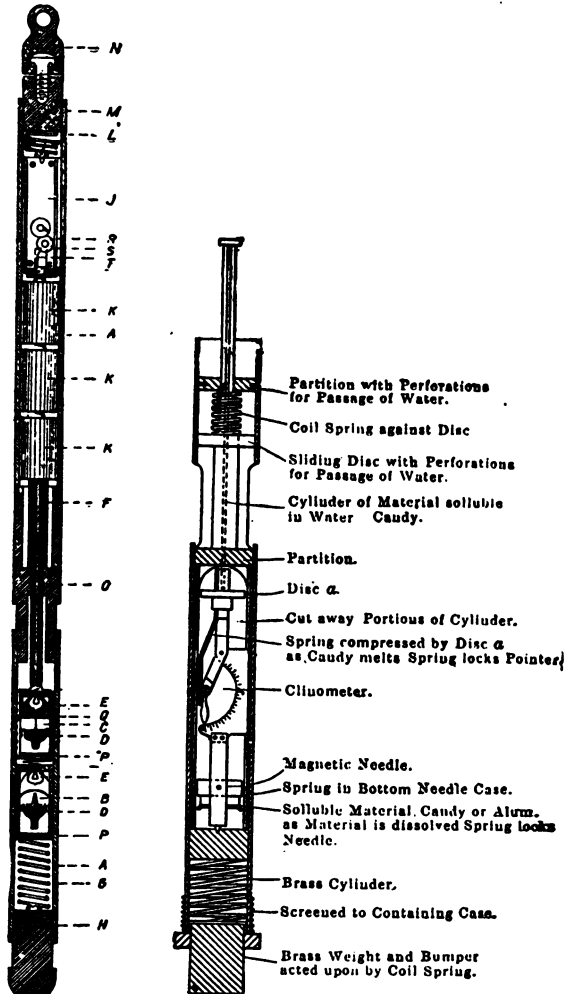

Fig. 62. Section of Surveying Instrument for Diamond Drill.

Fig. 63. The Azielometer.

previously been filled with water. Attached to the top of the containing case is an eye to which the end of a line of wire coiled on a winch is fastened. This wire is marked at 25-ft. intervals by means of white paint. The instrument in the case is then lowered by uncranking the winch to a point decided upon for taking the reading.

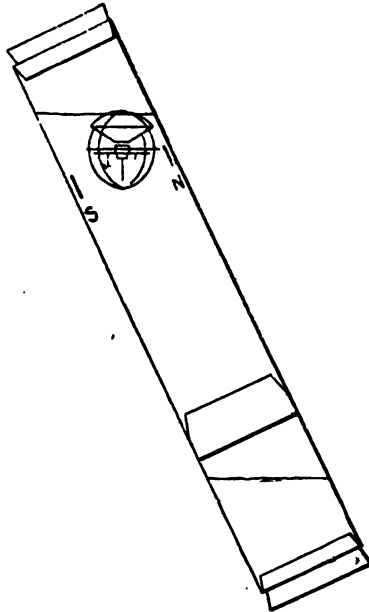

Fig. 64. Compass for Determination of Course of Drill Hole.

The clinometer disk and pointer are then free to assume the position due to gravity and the magnetic needle seeks the position of magnetic north since its case is free to assume a horizontal position on any inclination. In the course of perhaps half an hour the candy has dissolved and the framework which has housed the candy is free to contract due to the springs which are attached. As it does so, the levers act upon the clinometer and needle, locking both in their proper positions.

The containing case with the instrument is then hoisted and the readings are recorded. These readings are taken at intervals of from 25 to 100 ft. throughout the course of the hole. The readings are then plotted on the map by protractor, and the course of the drilling determined.

The magnetic needle is of course useless in detecting the azimuth of a drill hole in the magnetic formation, but away from influencing metals the readings should be of great value.

The instrument was invented by M. Garvey, a drill contractor in Mineville, N. Y.

The Gelatine Method. This was devised by Mr. E. F. Mac George and Fig. 64 illustrates the improved instrument invented by Mr. George Maas. A solution of one part hydrofluoric acid and 12 parts water is placed in the bottom of a glass tube, and a solution of $\frac{5}{6}$ of a grain of Nelson's Improved Brilliant

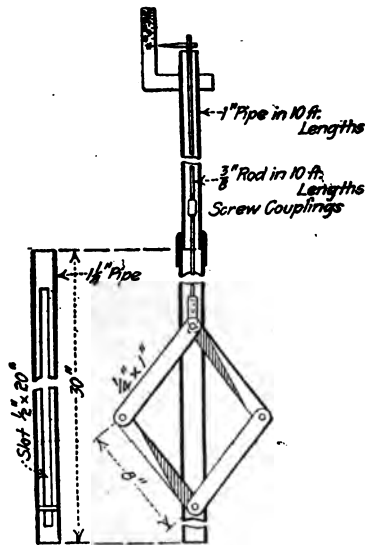

Fig. 65. Caliper for Drill Holes.

gelatine in 50 c.c. (cubic centimeters) of water, is placed in the upper part. A compass needle, pivoted in a cage to keep it from the sides of the bottle is floated in the gelatine. The gelatine will harden in 20 or 30 min., unless a special device is used to keep it warm. This instrument is of no use in magnetic ground.

A Drill Hole Caliper. A caliper for determining the size of drill holes was designed by Mr. H. S. Rands for use at the Lahonten Dam, Nevada. It is illustrated in Fig. 65, and its operation is evident.

Factors Affecting the Rate of Diamond Drilling. There is a great deal to be found in print relative to the cost of diamond

drilling, but unfortunately most of the records are published in such form as to be of far less value than they would be were all the cost factors given. By this I mean that any record of any kind of drilling to be of great value should give: (1) the rate of penetrating a given kind of rock when the drill is actually cutting; (2) the speed, power and weight of the machine; (3) the time lost in raising the drill to change bits, remove cores, or the like; (4) the time required to shift from one hole to the next; (5) the average time lost in repairs, break-downs, etc.; (6) the diameter and depth of hole; (7) the time consumed in driving and pulling casing. From data given in subsequent paragraphs I have prepared the following formulas to be used in computing the number of hours required to drill a hole of a given depth.

Let

T = Total number of minutes required to bore the hole.

n = total depth of hole in feet.

l = length of each coupling rod = 10 ft. in this case.

t = the number of minutes required to bore 1 ft. of the hole.

In the rock formation given by Heinrich (page 349) t = 19 min. per ft. of hole up to a depth of 300 ft., to which add 5 min. per ft. for each 100 ft. of increased depth.

r = time in minutes required to raise and lower the rods, including 2 min. to uncouple and couple up.

r = 7 min. for hole up to 300 ft. plus $\frac{1}{2}$ min. for each additional 100 ft.

s = number of lengths of coupling rod.

The time consumed in actual boring n feet is obviously nt . The time consumed in raising and lowering the drill rods is the sum of an arithmetical series in which s = the number of terms and r = the common difference; hence the sum is $\frac{1}{2}s(2r +$

$[s - 1])r$, which reduces to $\frac{s(1 + s)r}{2}$. The total time is there-

fore:

$$T = nt + s \frac{(1 + s)}{2} r$$

$$s = \frac{n}{l}$$

$$T = nt + \frac{n(1 + n)}{2l^2} r$$

if $l = 10$

$$T = nt + \frac{n(10 + n)}{200} r$$

$$T = nt + \frac{n^2 r}{200} \text{ nearly.}$$

For holes of the following depths we have:

n (feet)	=	400	800	1,200
t (minutes)	=	24	44	64
r (minutes)	=	7½	8¾	10
T (minutes)	=	15,500	63,000	148,800
T (hours)	=	259	1,050	2,480

On Heinrich's work about 10% more time than the above was required to cover losses from delays arising from various causes. The point that is strikingly brought out by Heinrich's records is the rapid falling off in the rate of speed of drilling each foot of hole with increased depth. The cause is obvious, however, for the longer the line of drill rods the greater the friction of the rods upon the sides of the drill hole, and consequently the slower their revolution with an engine of limited horse power. The increased weight of the rods with increased depth also reduces the rate of speed with which they are hoisted by the engine; and this is a very important factor in adding to the labor and fuel cost of drilling deep holes. Heinrich's estimates of the time required to drill holes, including all 10% allowances for delays, are as follows:

400-ft hole,	288 hours
800 " "	960 "
1,200 " "	2,616 "

It will be observed that these times check fairly well with the times obtained by applying the formula that I have given; but it should be added that the constants in the formula need further verification by other observers. The material penetrated in the 800-ft. hole was:

Hard silicious sandstone	210 ft.
Medium silicious sandstone	362 ft.
Argillaceous sandstone and slate	237 ft.
Limestone	18 ft.
Total	827 ft.

Heinrich's estimates of time, and my own formula based thereon, assume a uniform sandstone throughout in the three holes. Had the rock been uniform throughout, the cost would have been:

400-ft. hole, at \$1.26	= \$ 504
800-ft. hole, at 2.10	= 1,680
1,200-ft. hole, at 4.00	= 4,800

Cost in Virginia. From an admirable paper by O. J. Heinrich, in *Transactions American Institute Mining Engineers*, 1874, I have abstracted the following:

The diamond drill crew consisted of three men, two to run the *drill and one to help raise the drill rods, beside a foreman. The shift was 12 hr. long, and the following was the cost of operating a shift:*

Foreman, or boring master	\$2.50
Mechanic, or engineer	2.00
Assistant	1.50
Laborer	1.00
Total labor	\$7.00

The coal consumed was 10 lb. per hp. hr. For holes up to 1,000 ft. deep an 8 hp. engine was used, the drill rods weighing 4,500 lb.; but up to a 1,500-ft. hole a 12 hp. engine was used, with rods weighing 7,000 lb. The drill had a 2-in. bit, on which were mounted never less than 12 carbons, better 16. The drill rods were raised after every 10 ft. of drilling. The drilling was done in Chesterfield county, Va., prospecting for coal, in 1873. The cost of operating per shift is given as follows:

Labor	\$ 6.50
$\frac{1}{8}$ ton coal at \$3	1.00
Oil50
Diamonds and repairs	11.00
Interest and depreciation	1.92
Total per day	\$20.92

The price of carbons was \$10 per kt. Rates of wages were also much lower then, and it should be noted that the allowance for interest and depreciation is too low for a plant costing \$7,200, as it is stated this 8 hp. plant cost.

Depth of hole in earth and rock, ft.	419	850	1,142
Depth bored in rock, ft.	396	826	1,118
No. of 12-hr. shifts actually boring	13.88	14.41	59.29
No. of 12-hr. shifts raising rods	15.87	59.34	116.46
No. of 12-hr. shifts incidentals	3.25	15.25	68.25
No. of 12-hr. shifts total	33.00	119.00	224.00
Ft. progress per hr. while boring	2.37	1.55	1.57
Ft. progress per hr. average998	.578	.308
Cost of labor, per ft.	\$.36	\$.59	\$1.02
Cost of fuel (\$3 ton) per ft.53	.14	.17
Cost of all other items, incl. materials and blacksm'g ..	1.29	1.43	2.05
Interest16	.27	.38
Total cost per ft.	\$1.86	\$2.43	\$3.62

Time Lost in Diamond Drilling Operations. As the prospecting of a mining property by diamond drilling requires a large expenditure, the owners expect to get the desired information as quickly as possible. One of the most important items in the cost of this work is the time required for operations other than actual drilling, which may properly be called lost time; of this, pulling and lowering the rods account for the greater part. The proportion of time lost can be reduced by good judgment on the part of the drill runner. As indicating possibilities the following records of time lost are given by Mr. A. E. Hall in the *Columbia School of Mines Quarterly* for November, 1912. (*Engineering and Contracting*, Jan. 22, 1913.)

The following records show that in some cases less than 60% of the shift was used in actual drilling; the highest efficiency was

76%. This is one of the reasons for the high cost of diamond drilling.

During a period of 5.5 months, in which two drills ran for the whole time and two drills for 1.5 months only (equivalent to one drill for 14 months), a total of 10,278 ft. of hole was drilled, or 730 ft. per month per drill. The drills worked 26 days per month, on two 10-hr. shifts. This gives a general average of 14 ft. per shift. The speed of drilling is given in the tables following:

SHIFT I.—DEPTH, 735 FT.

Operation.	Time drilling. hr. min.	Time lost. hr. min.
Drilling (8 ft.)	1 30	
Pulling rods		35
Dropping rods		15
Drilling	2 53	
Lunch, 55 min.		
Pulling rods		34
Changing bit		2
Dropping rods		22
Drilling	3 27	
No water		40
Total, excluding lunch time ..	7 50	2 28
Time efficiency, 76%.		

SHIFT II.—DEPTH, 770 FT.

Operation.	Time drilling. hr. min.	Time lost. hr. min.
Dropping rods		22
Drilling (8.8 ft.)	3 57	
Pulling rods		37
Removing core, etc.		1
Dropping rods		23
Lunch, 1 hr. 26 min.		
Blowing cylinders		2
Running over core		7
Repairing gear		2
Running over core		9
Drilling (2.25 ft.)	1 39	
Pulling rods		34
Fixing core and bit		2
Dropping rods		22
Drilling	1 32	
Total, excluding lunch time ..	7 8	2 41
Time efficiency, 72.6%.		

SHIFT III.—DEPTH 803 FT.

Operation.	Time drilling. hr. min.	Time lost. hr. min.
Pulling rods		30
Fixing core and bit		2
Dropping rods		19
Drilling (4 ft.)	1 52	
Pulling rods		27
Fixing core and bit		2
Dropping rods		19
Drilling	1 9	

CORE DRILLS

351

	Time drilling. hr. min.	Time lost. hr. min.
Pulling rods		25
Dropping rods		20
Drilling (8 ins.)		3
Dropping rods		19
Pulling rods		28
Drilling (3.1 ft.)	1 31	
Pulling rods		28
Fixing core and bit		2
Dropping rods		21
Drilling	52	
Total	5 58	4 2

Time efficiency, 59.7%.

SHIFT IV.—DEPTH 820 FT.

Operation.	Time drilling. hr. min.	Time lost. hr. min.
Drilling	38	
Pulling rods		22
Fixing core and bit		2
Dropping rods		11
Fishing for core		6
Pulling rods		28
Fixing core and bit		3
Dropping rods		19
Running over core		12
Drilling	1 49	
Pulling rods		32
Fixing core and bit		2
Dropping rods		18
Drilling (3.67 ft.)	2 1	
Pulling rods		31
Fixing core and bit		2
Dropping rods		22
Drilling	1 46	
Total	6 14	3 30

Time efficiency, 64%.

SHIFT V.—DEPTH 550 FT.

Operation.	Time drilling. hr. min.	Time lost. hr. min.
Dropping rods		30
Drilling (4.67 ft.)	2 40	
Pulling rods		32
Dropping rods		23
Drilling (2.75 ft.)	1 20	
Pulling rods		35
Dropping rods		30
Fishing for core		05
Trial pull and re-running		05
Trial pull and re-running		07
Pulling rods		25
Dropping and hammering		25
Fishing		03
Pulling rods		25
Changing bits		09
Dropping rods		29
Pump repairs		42
Running to bottom		35
Drilling	0 35	
Total	4 35	6 01

Time efficiency, 43.3%.

HANDBOOK OF ROCK EXCAVATION

SHIFT VI.—DEPTH 572 FT.

Operation.	Time drilling. hr. min.	Time lost. hr. min.
Dropping rods		30
Drilling	2 15	
Trial pull		05
Re-running to bottom		16
Drilling	0 16	
Pulling rods		29
Removing core and examining bit		06
Dropping rods		22
Drilling	0 55	
Drilling	0 35	
Pulling rods		30
Examining core and bit		05
Dropping rods		26
Drilling (1.8 ft.)	1 12	
Pulling rods		47
Fixing core and bit		02
Dropping rods		16
Drilling (1.75 ft.)	0 55	
Pulling rods (part)		47
Total	6 08	4 41
Time efficiency	56.7%	

SHIFT VII.—DEPTH 600 FT.

Operation.	Time drilling. hr. min.	Time lost. hr. min.
Drilling (1.75 ft.)	1 00	
Pulling rods		30
Fixing core and changing barrels		05
Dropping rods		33
Reaming (6 ft.)		1 19
Drilling	1 43	
Lunch, 1 hr.		
Drilling	3 00	
Pulling rods		34
Fixing core and bit		11
Dropping rods		19
Drilling	0 46	
Total, excluding lunch time	6 29	3 31
Time efficiency	62.9%	

SHIFT VIII.—DEPTH 626 FT.

Operation.	Time drilling. hr. min.	Time lost. hr. min.
Drilling (8 ft.)	3 13	
Pulling rods		35
Removing core and fixing bit		10
Dropping rods		22
Running over core		04
Drilling	0 36	
Lunch, 1 hr. 5 m.		
Drilling	2 04	
Pulling rods		33
Fixing core and bit		08
Dropping rods		18
Drilling	1 37	
Total, excluding lunch time	7 30	2 10
Time efficiency	69.7%	

Cost and Speed of Diamond Drilling in Canada. In prospecting in the mining district at Porcupine, Canada, a great deal of diamond drilling has been done. Mr. Albert E. Hall in the *Columbia University School of Mines Quarterly* presents some data on the cost of this work.

In drilling operations at Porcupine one machine made 900 ft. in 26 working days of two 10-hr. shifts each. The rock was schistose, containing quartz veins and stringers. The inclination of the hole was 54 deg., while the formation dipped at 73 deg. in the opposite direction. Following are the itemized costs per foot:

COST PER FOOT

Management and diamond setting	\$0.167
Illumination (kerosene lamps)	0.100
Coal	0.295
Lumber	0.050
Casing pipe	0.010
Freight	0.100
Blank bits	0.010
Core barrel and shell	0.010
Labor: Runners, \$100 per month.	
Firemen, \$2.75 per day.	
Core checkers, \$2.75 per day	0.521
Wear of carbons	0.175
Water	0.050
Depreciation of plant	0.005
Depreciation of carbons	0.016
<hr/>	
Total per ft.	\$1.509

In the case of another drill working in the same formation and under the same conditions, the costs, based on 1,163 ft. of hole drilled in 34 working days, amounted to \$1,566 per ft. This includes the sinking of a stand-pipe to a depth of 30 ft., which took three days. Coal cost \$7 per ton laid down at the drill.

The following data refers to holes drilled in schistose rock with quartz veins and stringers. The holes were of $1\frac{1}{2}$ in. diameter and were bored at an angle of 54 deg. The first half of the table shows what the speed would be if all the time were consumed in drilling; the figures in the second half are from actual observation, whence the time required for handling the rods and for making necessary repairs can be deduced.

SPEED OF DIAMOND DRILLING: $1\frac{1}{2}$ -IN. HOLE

	Theoretical: no allowance for pulling rods, etc.			Actual: including pulling of rods, adding rods, etc.		
	Per hour	Per shift	Per day	Per hour	Per shift	Per day
Maximum, ft.	5.4	54.00	108.0	5.0	36.0	71.0
Minimum, ft.	2.9	29.0	58.0	1.0	14.0	26.75
Average, ft.	3.75	37.5	75.0	1.7	17.5	35.0

Holes dipping with the formation, Mr. Hall states, seem to give better core than those that dip across the formation. In

the first case the recovery is 95 to 100%, while in the second case it is between 90 and 95%. In drilling parallel to the dip, single pieces of core 10 ft. long have been obtained with a core barrel 10½ ft. in length.

Cost of Diamond Drilling in British Columbia.* Mr. Frederick Keffer is author of the following:

Two years ago I contributed to the Institute a paper on the results of diamond drilling as carried on at the mines of the British Columbia Copper Company, Limited, during 1905. That paper gave some details as to costs, and the period covered was but 8½ months. Since that year drilling has been carried on more or less continuously in the mines of the company, and the results of this work, so far as progress and costs are concerned, are given in detail in the following tables.

Table XXXIX gives the monthly results of work as well as the yearly totals. It is, of course, important to know the general character of the rock drilled in order to institute comparisons with other localities. In the narrow limits of this table it is not possible to give details as to rocks, but as nearly as possible the rocks comprise diorites, compact garnetites and certain very hard and silicious eruptives occurring in Summit camp. The medium hard rocks include all ores, and, in Deadwood camp, much of the greenstone country. The soft rocks are the limestones, porphyries and serpentines. Of all rocks drilled the garnetites proved much the most severe in diamond consumption, as is illustrated by the work from May to August, 1907, which was mainly conducted in garnetite with some silicious limestones.

Eight hours constitute a shift underground, and nine hours on the surface. On Sundays no work is done apart from repairs to machinery. In May, 1906, the labor was contracted as an experiment, but was abandoned as being unsatisfactory.

The employees were, normally, a runner and a setter. Extra help was required at times for blasting places for good set ups, for laying pipe lines, moving plant, etc. In August, 1907, two shifts were employed. In June and July of that year the increase in labor costs is mainly on account of the long pipe lines required.

The power consumed is taken as being equivalent to that required for a ¾-in. percussive machine drill, that is to say, about 20-hp. When drilling at a mine, where for example 15 machines are used on each shift, the diamond drill is charged with ⅓ of the total power costs — it being in this instance run on one shift only.

Where steam power is used either directly or through a steam driven air compressor, the costs are much increased. Where, as

* *Engineering and Contracting*, May 6, 1908: abstract of a paper before the Canadian Mining Institute, with additional data furnished by the author.

in some cases, an isolated 24-hp. boiler was used, the power costs are still higher, as an engineer has to be provided as well as a team to haul wood.

Tools, repairs, etc., include these items as well as all small miscellaneous expenses. The increasing cost of diamonds (\$80 per carat in 1907 as compared with \$60 in 1906) added materially to cost per foot in 1907.

The carats used per foot were 0.572/64, or in more intelligible decimals, .00893 carats, so that one carat on the average drilled 111.9 ft. All holes over 30 deg. dip are classed as vertical, and ft. per hr. in horizontal holes is about 15% greater than in vertical ones. The average depth of holes is 81.3 ft., and diameter of cores is 15/16 in.

In comparing these costs with contractors' prices, it must be borne in mind that contractors usually require air (or steam) and water to be piped to the work, and the mine must in addition furnish the air and water free of charge. In the present cost sheets all these items are charged against costs of drilling.

The drill runner himself set and was responsible for the diamonds. He was paid a salary of \$175 per month, while two helpers, during the period of time given, received \$3.50 per day. Since the decline in the price of copper, helpers are only paid \$3.30 per shift. The compressor men receive \$4 per day.

Wood for fuel costs \$3.50 to \$5 per cord, according to locality. Electric power costs \$33 to \$40 per hp. per year.

The drilling was done with a "Beauty Drill," of the Bullock type, made by the Sullivan Mch. Co., of Chicago. The machine has been in service three years and is in excellent condition. The catalog price of the drill is \$1,500, with its equipment, including 2 bits ready for carbons, but not including carbons. The shipping weight is 1,160 lb. It will drill to a depth of 800 ft., making a hole 1-9/16 in. in diam. and giving 15/16 in. core.

The following were the unit costs in 1906 and in 1907, also in March, 1907, when the lowest unit cost was secured:

COST IN 1906 (3,002 FT. DRILLED).

	Per ft.
Labor	\$0.786
Power	0.205
Repairs, oil, etc.	0.109
Carats (28 56/64, cost \$1,728)	0.578
Total	\$1.678

COST IN 1907 (3,667 FT. DRILLED).

	Per ft.
Labor	\$0.715
Power	0.280
Repairs, oil, etc.	0.100
Carats (30 47, 64, cost \$2,323)	0.633
Total	\$1.728

HANDBOOK OF ROCK EXCAVATION

COST IN MARCH, 1907 (540 FT. DRILLED).

	Per ft.
Labor	\$0.492
Power	0.099
Repairs, etc.	0.049
Carats (2 37/64, cost \$219)	0.405
Total	\$1.045



Fig 66. Sullivan Diamond Drill Drilling an Upper Hole.

Mr. Keffer estimates 16% per year will cover the interest and depreciation, or \$240 per year to be added to the costs above given, or about 8 ct. per ft. of hole when 3,000 ft. are drilled per year.

Cost of Diamond Drilling in the Colorado Coal Measures. The following are figures of cost (*Engineering and Contracting*, Mar. 13, 1907) of making diamond drill borings in the Colorado coal measures, the material penetrated being compact sandstone with layers of clay and shale. Altogether 19 holes were sunk. The outfit used was a Sullivan Class CN coal prospecting drill, with a capacity of 500 ft., and 2-in. core. This was complete with all *necessary apparatus*. Three sets of holes were drilled, one of *nine holes*, one of *seven holes* and one of *three holes*. The drill-

CORE DRILLS

TABLE XXXIX. PROGRESS TABLE

	Depth of holes.	Hours actual drilling.	Hours moving to new holes, setting bits, etc.	Total hours.	No. of holes.	Crats used.	Ft. per drill.	Character of Rock.
Jan., 1906	170	106	46	152	61-64	1	1.60	Mainly hard diabase. ¹
Feb., 1906	191	104	24	128	3 47-64	3	1.83	Softer lime rock. ³
March, 1906	308	205	77	282	3 35-64	3	1.04	Equal parts of above rocks. ²
April, 1906	214	76	55	131	1 50-64	7	2.81	Lime rocks and ore. ²
*May, 1906	463	160	48	208	5 36-64	4	3.17	Nearly all in ore. ²
August, 1906	508	99	8	232	3 25-64	7	2.45	Pearly hard rock. ²
Sept., 1906	235	95	53	148	2 10-64	0	2.45	Mainly ore. ²
Oct., 1906	411	157	63	220	2 40-64	4	2.62	Hard silicious rock. ¹
Nov., 1906	411	144	48	192	4 8-64	6	2.10	Hard silicious rock. ¹
Dec., 1906	316	144	48	192	4 8-64	3	2.10	Hard silicious rock. ¹
Total	3002 7	1,076	417	1,493	45	28 56-64	2,359 4	
Jan., 1907	411	159	57	216	6	1 3-64	2.58	Limes and porphyry. ³
Feb., 1907	378	137	79 5	216	2	1 50-64	2.76	Ore and limy rock. ²
March, 1907	540	180	28	208	5	2 37-64	3.00	Ore and limy rock. ²
April, 1907	464	181	27	208	1	3 18-64	2.56	Ore and limy rock. ²
May, 1907	500	163	53	216	3	5 4-64	3.07	Hard garnetite. ¹
June, 1907	477	187	39	226	6	5 16-64	2.55	Very hard garnetite. ¹
July, 1907	400	203	23	226	6	7 3-64	1.37	Very hard garnetite and diorites. ¹
Aug., 1907	497	213	129 6	342	8	4 44-64	2.33	Very hard garnetite. ¹
Total	3667 8	1,433	435	1,858	37	30 47-64	2,577	

* This month's work was contracted as to the labor. Feet drilled are therefore not included in averages as contractor worked overtime.

- 1 Hard rocks.
- 2 Medium hard rocks.
- 3 Soft rocks.
- 4 Averages calculated on 3,002 ft. less 463 drilled on contract.
- 5 Several days lost moving 15 miles to another mine.
- 6 Much trouble with caving ground in August. Worked two shifts nearly all the month.
- 7 Of these 3,002 ft., there were 1,523 ft. vertical and 1,479 ft. horizontal.
- 8 Of these 3,667 ft., there were 1,573 ft. vertical and 2,094 ft. horizontal.

ing gang in each case was made up of one foreman at \$150 per month, who had charge of the day drilling; one night driller at \$3.50 per day; two assistants at \$2.50 per day; one teamster at \$2 per day, and a cook at \$50 per month. The foreman kept records, set diamonds, bought supplies, etc. The men all received board and lodging free.

The following figures are average costs per foot for each set of tubes. In Set 1 nine holes were drilled a total depth of 4,736 ft.; in Set 2 seven holes were drilled a total depth of 3,040 ft., and in Set 3 three holes were drilled a total depth of 1,767 ft. The itemized costs for each set of holes were as follows:

	Set 1 per ft.	Set 2 per ft.	Set 3 per ft.
Foreman	\$0.070	\$0.068	\$0.180
Labor	1.150	0.810	1.700
Camp account	0.540	0.350	0.545
Supplies	0.080	0.023	0.128
Repairs	0.190	0.125	0.170
Carbon	0.866	0.221	0.650
Fuel	0.020	0.050	0.210
Total	\$2.916	\$1.647	\$3.583

The figures do not include interest and depreciation on plant, transportation, etc. They are from records kept by Mr. W. F. Murray, Engineer with the Victor Fuel Co., of Denver, Colo.

Cost of Drilling in Prospecting for Coal, in Greene County, Pa.* Mr. E. E. White gives the following data in drilling a 2½-in. core. The surface earth was from 6 to 19' ft. deep, averaging 10 ft. It was clay with no boulders and was drilled out with a mud bit. The drill worked a day shift only, and was run by a drillman and a fireman. The bits were not set in the field but in the shop. The hours in the progress table refer to two men, except in the case of setting bits. The total cost was somewhat less than \$1.13 per ft. for 5 holes, total length 1820 ft.

	Bits used, ft.	Carbon wear, carats.
Mud-bit	48	
Diamond bit No. 1, carbons broken by steel		2¼
Diamond bit No. 2 (hole No. 1)	370	½
Diamond bit No. 3 (hole No. 2)	339	½
Diamond bit No. 4 (holes Nos. 3, 4)	500	½
Diamond bit No. 5 (hole No. 5)	563	½
Total	1,820	4¾

RATE OF BORING.

Kind of Rock.	Ft. per hr. actual Cutting.
Shale	7.05
Fireclay	7.10
Limestone	7.20
Sandstone	9.35
Coal	15.15

* Reprinted from *Engineering and Mining Journal in Engineering and Contracting*, April 21, 1909.

CORE DRILLS

359

	Cost per ft.
Drillman	\$.169
Fireman106
Blank bits003
Setting bits005
Carbons (4¼ carats at \$90)210
Fuel (1,050 bu. coal at 6.5ct.)037
Oil and waste006
Repairs014
Moving020
Superintendence110
Total working cost	\$.680
Depreciation (20% on \$2,000 machine for 3 mos.)055
Total cost exclusive of freight and hauling on drill and wages and expenses of drillmen to and from Green county	\$.735

PROGRESS (1820 ft.):

Hours actual cutting	233
Hours pulling core, lowering rods, etc.	172
Hours drilling	405
Hours delay, steaming, repairs	222
Hours tearing down, moving, setting up	142
Total hours	769
Hours setting bits (not included above)	20
Feet per 10-hr. shift after setting up	30
Feet per drilling hour (excluding time setting bits)	4.5
Feet per hour actual cutting	7.82

The cost for carbons would have been much less but for the fact that 2¼ carats were broken at a depth of 21 ft. in the first hole, probably by a piece of steel in the hole. This bore was abandoned and another started 2 ft. away.

Considerable trouble was experienced with the boiler on the first two holes, which accounts for a large part of the delay on these holes. The boiler was of the upright type, set behind the machine on the heavy wagon frame. There were no stay bolts, and the flues frequently had to be rolled every three or four days after the first week, and finally were rolled every day for three days in succession. After stay bolts were put in, the flues were not rolled again on the job. Except for the boiler and a troublesome donkey pump which supplied the water tank, the outfit was excellent. The delay on the last hole was mostly waiting for water, which had to be pumped a little over a quarter of a mile.

The expense of pumping on the last hole is not included, as it was borne by the owners of the coal. The contract read that water should be furnished within 100 ft. of each hole. The cost of moving on and off the ground is not included, as it would be variable, according to the distance and means of transportation: The distance moved between holes averaged about a mile by road. It was open country with good roads, so that moving was not expensive.

Cost of Drilling in Lehigh Valley. Mr. L. A. Riley is authority for the following, as given in *Trans. Am. Inst. Min. Eng.*, 1876: Two machines belonging to the Lehigh Valley Coal Co. were used. A No. 2 drill with 16-hp. boiler and 1,000 ft. of 2-in. rod cost \$3,900, which with diamonds, etc., came to \$5,000; the weight being 3,500 lb. Carbons cost \$9 per carat, and bortz cost \$11. Five diamonds weighing 18 carats were used per bit, drilling a 2-in. hole and bringing up a 1½-in. core. There were 24 holes, aggregating 9,902 ft., the deepest being 900 ft. The average rate of drilling these holes was 19 ft. per day per machine, at an average cost of \$2.22 per ft. The rock was a very hard sandstone and conglomerate. The force on each drill was one foreman, one engineer and one fireman. The average cost per ft. of hole was:

Labor	\$1.15
Diamonds66
Supplies and repairs41
Total	\$2.22

The cost of the 900-ft. hole (the deepest) was \$1.95 per ft., which indicates that with a powerful (16-hp.) engine there is no such great increase in cost per ft. with increased depth as Heinrich found (page 349) with an 8-hp. engine. The 16-hp. plant used by Riley was capable of drilling a 2,000-ft. hole. Note especially that both Riley and Heinrich paid less than \$10 a carat for carbons and that Riley does not say what proportion of carbons to bortz were used.

Cost of Drilling on Croton Aqueduct. Mr. J. P. Carson, in *Trans. Am. Inst. Min. Eng.*, 1890, gives the following:

Fourteen holes, total 2,084 ft., were drilled in the year 1886.

Actual days worked	169 days
Moving drill	15 days
Idle	18 days
Holidays and Sundays	39 days

Total 261 days

	Daily Progress Ft.	Cost per Ft.
347 ft. Hard gneiss	11 to 12	\$3.97
814 ft. Decomposed gneiss	23.1 to 28	1.15
572 ft. Clay, gravel and boulders	6.7 to 9	4.07
351 ft. Clay and gravel	25
2,084 ft. Average	10.2	\$2.91

Crew, 1 foreman at \$125 mo.; 1 assistant foreman at \$70; 4 men at \$65. Wages, 8.1 mos.	\$3,785
Team moving	80
68.7 tons coal (189 days)	360
Supplies, Diamond Drill Co.	472
Foundry	291
Lumber, rope, etc.	53

Interest on \$6,000 plant at 1 per cent. per mo.	486
Renewing diamonds	250
Diamond bit lost	300
Total, 204 days	\$6,077
Average per day	\$29.79
Average per ft.	\$ 2.91

Note that no charge is made for plant depreciation and that the interest charge assumes a plant working with little lost time.

Cost of Drilling in Michigan and Minnesota. The following records of cost were compiled by Mr. J. Parke Channing (*Engineering Magazine*, 1896, p. 1,075) and are self explanatory.

TABLE XLI. COST OF DIAMOND DRILLING

	A. 2 holes, 634 ft., per ft.	B. 2 holes, 360 ft., per ft.	C. 6 holes, 1350 ft., per ft.	D. 2 holes, 611 ft., per ft.	E. 6 holes, 2091 ft., per ft.	Total. 18 holes, 5046 ft., per ft.
Labor on driller	\$.905	\$.455	\$.862	\$.674	\$.606	\$.709
Firemen379	.266	.338	.265	.206	.275
Chopping wood339	.419	.329	.126	.182	.251
Camp account495	.519	.595	.644	.722	.636
Bits and repairs on driller165	.040	.087	.138	.126	.116
Supplies and rep'rs on mach'y097	.020	.092	.076	.097	.088
Carbons733	.227	.209	.553	.239	.330
Superintendence172	.347	.220	.106	.196	.199
Total and cost per ft.	\$3.286	\$2.293	\$2.732	\$2.582	\$2.374	\$2.604

Cost at East New York Mine, Ishpeming, Mich. (3,746 ft.)

	Total.	Per ft.
400 days setter at \$3.00	\$1,200.75	
372 days runner at \$2.25	837.00	
230 days runner at \$2.00	460.50	
4 days laborer at \$1.75	7.85	
Labor	\$2,506.10	\$.669
Carbon, 68% karats at \$15.44	1,035.47	.276
Bits, lifters, shells and barrels and repairs	433.81	.115
Oil, candles, waste and supplies	128.09	.035
Estimate cost compressed air	374.60	.100
Total	\$4,478.07	\$1.195
		Ft.
Number holes drilled		
Drill in hematite		193
Drilled in jasper		646
Drilled in mixed ore		986
Drilled in diontic schist		1,921
Total		3,746

603 ten-hr. shifts drill was running including moving and setting up; 6.2 ft. per 10-hr. shift.

Cost in Michigan. Mr. J. Parke Channing, in a paper read before the *Lake Superior Mining Institute* in 1894, gives the cost of drilling in quartzite overlying iron ores in Michigan. The first hole, 2,901 ft. deep, was drilled in 1892-3 from a pit, and including pumping the pit, cost as follows:

	Per. ft.
Labor on drills	\$.606
Fireman206
Fuel182
Camp equipment722
Repairs on drills126
Repairs on boilers, etc.097
Carbons239
Superintendence196
Total	\$.2,374

Diamond Drill Holes Used in Mining in Northern Minnesota. Mr. F. W. Denton (*Transactions American Institute Mining Engineers*, Vol. 27 [1897] pp. 340-390) gives the rate of drilling slope holes in iron mine drifts with Sullivan "E" diamond drills. The drills, run by compressed air, were mounted on cribbing and braced securely. The holes varied from 20 to 33 ft. in depth, averaging 25 ft. About 12 ft. were drilled in 10 hr. In a slope 40 ft. wide two holes are put in, one pointing to the hanging-wall, the other to the foot-wall, and were sprung with dynamite. They are then charged with 30 to 50% dynamite. These holes dislodge between 300 and 1000 tons of ore. The cost of drilling was greater than with percussion drills, but the cost per ton dislodged was much less.

Cost of Diamond Drilling at Douglas Island, Alaska. Mr. A. Schoenberg, in *Mine and Quarry*, Jan., 1914, gives the following data relative to the cost of operation of a Sullivan "Champion" diamond drill during 1913, used to prove up deposits of gold ore on some of the properties of the Alaska-Treadwell Gold Mining Company. The rock in which the drilling was done was diorite, quartz, green-stone, and slate. The diorite and quartz were very hard, and the green-stone was ordinarily the best material for drilling, for, while not as hard as the diorite and quartz, it would drill hard enough to provide very good cores. The slate was very soft but through it ran quartz seams making very rough cutting, hard upon the machine and upon the diamond. The diorite was so hard as to put a glass polish upon a bit set with diamond chips in from 4 to 6 ft. of drilling. Good results were obtained by setting some small diamond chips which had been saved by the mine from work done about 16 years before.

The following table shows the cost of five months' work to Aug. 31, 1913. The distance drilled was 3,048 ft. in which 21.6 carats were used.

	Per ft.
Labor	\$.798
Carbons at \$90 per karat637
Repairs012
Supplies083
Assaying083
Power211
Total	\$.1,824

All work was performed from the main drift of the mine. The space occupied by the machine was 6 x 6 x 15 ft. The number of feet drilled was 4,318 and the longest hole was 1,006 ft., in slate and quartz, from which 900 ft. of 1½-in. core was secured.

Power was estimated at \$65 per mo. for each of the two machine drills. During August 900 ft. was drilled at a cost less than \$1.00 per ft. The carbon loss during this month was \$0.125 per ft.

The information gained by the diamond drill was accurate, a high percentage of core being saved. The time taken to do the

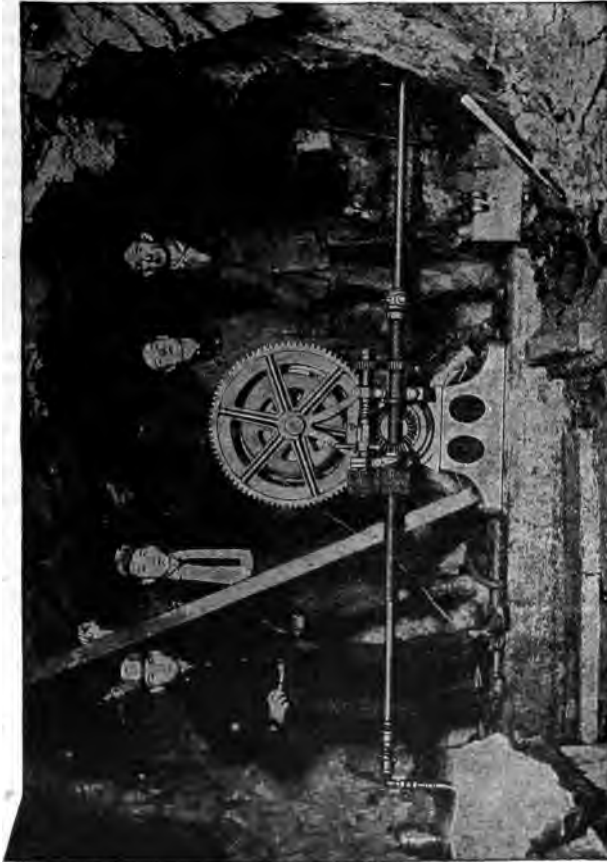

Fig. 67. Sullivan "Champion" Core Drill.

work in this manner was about one-quarter the time it would have taken if drifting or tunneling had been employed, and at about one-sixth the cost.

Contract Costs of Drilling in the Lake Superior Copper Country. In 1911 the cost of diamond drilling on the Indiana property was \$3.32 per ft. for 3,594 ft.; on North Lake it was \$3.30 per ft. for 3,210 ft.; and at the Mayflower properties it was \$2.40 per ft. for 7,294 ft. Other reports indicate that in drilling 4,915 ft. between May, 1910, and Jan. 1912, under heavy overburden conditions, the cost was \$4.07 per ft.

Progress in Drilling an Inclined Hole. Mr. W. T. Roberts in *Mine and Quarry*, (1911) describes the drilling of an inclined hole for a stand pipe at Ogdensburg, New York. The hole was started at an angle of 60 deg. and was sunk through 372 ft. of sand and gravel, boulders and quicksand, in 111 working days, or at the rate of 3.35 ft. per 10-hr. day. The inclination of the hole at this distance was 44 deg. Between 140 and 255 ft., 50 blasts of 2 or 3 lb. of dynamite were resorted to in order to get through boulders. The remaining 836 ft. were mostly in limestone, with occasional wide bands of quartz, hornblende, granite, and pyganite. It required 37 days to drill 836 ft. which was at the rate of 22.6 per day or 11.3 ft. per shift. The angle of the hole at the bottom was 39 deg.

Cost of Hand Diamond Drilling in Arizona. In *Engineering News*, Jan. 18, 1900, Mr. J. B. Lippincott gives data on diamond drilling at the Gila River Dam site, Arizona. The machinery was in two distinct parts, (1) the hand pile driver for sinking casing pipe to bed rock; (2) the diamond drill. The hammer, made by the Pierce Well Co., New York, is in sections, so that its weight can be varied up to 190 lb.; it is raised by a hand winch, and tripped by nippers; maximum drop 11½ ft. A tool-steel head is screwed into the top of the pipe and receives the blow. The pipe is 3½, 2½ and 2 in., extra heavy, screw pipe, 5 ft. sections, with extra heavy couplings which have beveled edges. When the casing has reached bed rock, the sand inside is removed by using a chopping bit and a water jet. The bit is screwed to a ¾-in. pipe through which water is pumped by a hand pump, the water passing out through holes in the bit, thus bringing the sand to the top of the casing. In this manner a casing pipe 130 ft. deep can be cleaned of sand and gravel. If a boulder is struck, after the diamond drill has penetrated it, four or five sticks of dynamite are lowered and discharged, shattering the boulder so that the casing can be driven down.

The diamond drill was made by the American Diamond Rock Drill Co., New York City. One inch core bits were usually employed. The drill was operated by hand power, six men being

employed on this work as well as on driving the casing. The drill will penetrate 200 ft. into rock, and will make 6 to 8 ft. per day in hard rock and 10 to 15 ft. per day in soft rock. The plant complete costs \$1,000, including two diamond bits worth \$200 each, set with six 1-carat diamonds each. Two machines were used. The pipe cost \$600 and freight, \$100.

Cost of operation per month, foreman	\$150
6 laborers at \$1.50 for 28 days	234
1 cook	45
	\$429
240 rations at 60ct.	144
Total labor for one month	\$573
Total time occupied, months	10
Total holes drilled	52
Total feet drilled	3,254

	Per ft.
Labor	\$1.761
Supervision108
Team, feed, etc.108
Moving206
Sundry, incidentals132
Repairs, pipe, lumber153
Total	\$2.468

	Earth, ft.	Rock, ft.	Total, ft.
The Buttes	1,621.2	196.0	1,817.2
Queen Creek	357.8	55.6	413.4
Riverside	729.8	40.2	770.0
Dykes	80.0	.0	80.0
San Carlos	143.2	30.4	173.6
Totals	2,932.0	322.2	3,254.2

A month's time of one party was lost due to continual breaking of the casing pipe under the hammer. Note that 90% of the drilling did not involve the use of diamonds but consisted in driving through the earth covering overlying the rock. This is characteristic, however, of testing dam sites.

It is interesting to compare with this the results of boring with hand machinery in other localities.

At St. Mary's Lake, in Montana, flush joint casing was sunk by the jetting process by hand labor, under charge of Cyrus C. Babb. Diamond drill cores were taken from each hole by hand power. The work was especially difficult on account of frequent boulders encountered. The outfit of machinery, including freight and excluding carbons, cost \$1.400.

The drilling expenses were \$3,080, or about \$1,000 per month.

The total amount of drilling accomplished, not counting holes that were abandoned on account of difficulties before completion, was 550 ft., at an average cost of \$5.60 per ft., exclusive of the cost of machinery.

In 1901 drilling was done in Tonto Basin, on Salt River, Ari-

zona. The Pierce driving rig and American Diamond Drill Co.'s hand drill were used, and hand power employed exclusively. The period of work covered a little over two months. Exclusive of the transportation of men, and of the first cost of machinery, the cost was as follows:

Pay roll	\$1,400
Subsistence and camp expenses	460
Repairs and miscellaneous	340
Total	\$2,200

Total amount of drilling, not counting unfinished holes abandoned on account of accident or difficulty, 905 ft. Cost per ft., \$2.43.

Diamond Drilling on the Mesabi. Bulletin No. 1 (year 1913) of the Minnesota School of Mines Experiment Station, gives the cost of prospecting in Minnesota with a diamond drill. The outfit cost \$2500, exclusive of the diamonds, and consisted of the following: 1 Sullivan diamond drill "H" of 1,000 ft. capacity, 1 No. 5 Cameron pump. Evred-model, churn drill, 20-hp. vertical boiler, extra heavy tools, drill rods, 200 ft. of 3 in. and 500 ft. of 2-in. casing, and 30 ft. tripod.

Diamonds cost about \$90 per carat. The stones ranged from 4 to 9 carats; 4 or 5 carat stones were preferred. Diamond setters received \$118 per month, and a man set from 5 to 6 bits in 10 hrs. In hard seamy rock, 2 bits per drill shift were needed. Reaming consumed 1.5 hr. per shift.

A 5/16-in. hole was driven 1,633 ft. in 131 shifts, during 94 calendar days, or at the rate of 12.4 ft. per shift. The cost was \$0.80 for labor, \$0.60 for supplies, and \$1.85 for diamond consumption, or a total of \$3.25 per ft. The average cost of diamond wear is about \$1.50 per ft. The average rate of drilling per shift was 8 to 20 ft. in hard slate, 5 to 15 ft. in quartzite and decomposed taconite. The average cost of churn drilling is \$1.75 to \$2.00 per ft. and of diamond drilling \$3 to \$3.50 per ft.

Method of Deep Sea Diamond Drilling. In *Engineering News*, June 29, 1893, Mr. Alfred Palmer gives data on deep water diamond drill boring for a tunnel under the Straits of Northumberland, between New Brunswick and Prince Edward Island, Canada. Ten holes were made, six being deep sea borings. A large table gives the character of material encountered in each hole. The holes ranged from 60 to 185 ft. deep, mostly in red shale and sandstone. The deep sea holes averaged 60 ft. A special apparatus had to be devised to withstand the force of a 3.5 knot current, 36 lb. per sq. ft., and the effect of heavy seas in a storm, in water 100 ft. deep. A trussed wrought iron 4-in. tube was held perpendicular by four ½ ton anchors, attached by a "watch tackle" near the top of the pipe. Near the top of this

tube was fastened a light platform to support a 300-lb. steam diamond drill. In water under 35 ft. deep, the 4-in. pipe required no trussing. The pipe was in 20-ft. sections, screwed tight with chain spanners, and dipped in boiling tar. A large

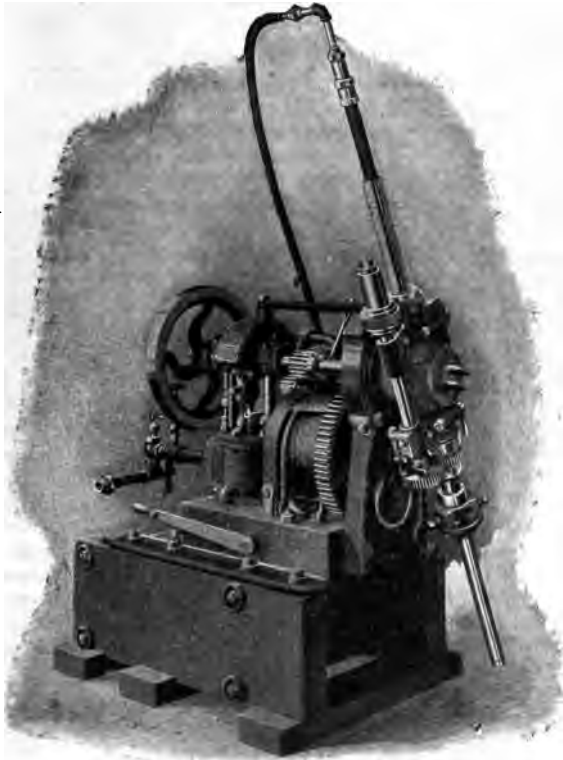

Fig. 68. Sullivan Class "S" Diamond Core Drill. (Capacity, 500 ft.; diameter of core, 15-16 in.)

iron plate was fastened to the pipe 2 ft. above its bottom to prevent settlement into the mud. A 2-in. casing pipe was lowered through the 4-in. pipe. The water was pumped down the centre of the drill rods. A scow anchored near by supplied *steam and water* through flexible pipes.

Comparative Cost of Drilling and Wash Boring on the Deep Sea Waterways Survey, N. Y. This work was done for the "Deep Waterways Survey," Great Lakes to Atlantic Tide Waters, in 1897-1900. (See *Engineering and Contracting*, Dec. 9, 1908.)

ORGANIZATION OF DIAMOND DRILL CREW.

	Per mo.
1 Superintendent	\$125
1 Foreman	100
1 Teamster, team, wagon, extra wagon, tank	90
2 Laborers at \$55	110
1 Night watchman	55
1 Machinist and diamond setter	100
Total	\$580

The drill used was a Sullivan "S" drill mounted on wheels. A 15-hp. portable boiler and a Blake pump were used. Twelve carbons (24 carats) came with the outfit, which was rented for \$300 per month, plus list prices for parts broken or destroyed plus \$36.50 per carat for wear and breakage of diamonds. The remaining plant consisted of a shanty, a derrick, core boxes, etc.

In 8 mos., 25 holes were drilled, total, 2,461 ft. (of which 1,906 ft. was rock), in 188 days worked. The time expended was 325 hr. sinking 552 ft. of casing through earth, 753 hr. drilling rock, 356 hr. moving the outfit and 386 hr. delays. The rock was limestone (444 ft.), sandstone (363 ft.), shale (880 ft.) and quartzite (222 ft.).

The cost per ft. (2,461 ft.) was:

	Per ft.
Rent of outfit (\$300 per mo.)	\$.90
Carbons (\$36.50 per carat)37
Labor06
Teamster71
Teaming, extra25
Superintendence11
Repairs39
Fuel (\$3 per ton)05
Lumber for shed and derrick02
Sundries03
Core boxes01
Traveling expense09
Freight, express and transporting men21
Total per ft.	\$.320

There were 22 core bits used. Wear was $16\frac{3}{4}$ carats and breakage 9 carats. The average stone weighed 2.14 carats and the life averaged 164 ft. per stone. The least wear was in a shale, where as much as 390 ft. was drilled without resetting the stones and only $4\frac{1}{4}$ carat was consumed. The greatest wear was in quartzite where five bits were used in a hole 108 ft. deep and $2\frac{5}{4}$ carats were consumed in about 160 ft.

Cost of Drilling in New York City. Mr. F. Lavis, in (*Engineering and Contracting*, Jan. 7, 1907) gives the following data of work done in New York City in the fall of 1905. The time occupied was from October to January, about three months, including delays due to snow and ice. The material was gneiss and mica schist, and was easily drilled save where seams threw the drill off line or bound the bit. The average depth of hole was 49 ft., the rock being from 2 to 25 ft. below the surface.

Wash Borings. A 2½-in. wrought iron pipe casing was sunk to rock by the wash method, and a 1¼-in. core of the rock obtained. The crew occupied in this work comprised 1 foreman at \$3 per day and 3 laborers at \$2. A proportion of superintendence, water supply, watchman, etc., was charged to this part of the work. The crew sank all the casings to the rock ready for the diamond drill machine in about 15 working days.

Diamond Drilling. Power for the diamond drill was furnished by a small upright boiler and much time was wasted in shifting the boiler and drill apparatus from one hole to another. Had these been both mounted on wheels the expense for drilling would have been cut down at least 10% and probably more. After the first two moves had been made an extra laborer (sometimes 2) was put on during the time of moving at \$2 a day, with the result that the time was cut down half, from 12 to 16 hr. actual working time to 6 or 8.

A superintendent, who also set all the diamonds, devoted about half this time to the work and was paid \$100 per month and \$100 per month rent was paid for the use of the diamond drilling machine. The boiler and wash boring outfit were on hand, having been used previously, and no cost is included for their use. The costs do include an allowance for all pipe used, cost of fuel and other materials and of repairs to diamond machine on completion of work, and new grate bars for the boiler.

The pay-roll was as follows:

1 Superintendent (½ time)	\$100.00	per month
Rent of machine	100.00	per month
1 Foreman	3.50	per day
1 Rigger	2.25	per day
2 Laborers	2.00	per day
1 Night Watchman	1.50	per day
1 Inspector of city water department	3.00	per day

Water was obtained from the city hydrants and cost about \$25 for permits, etc., besides the \$3 per day for the inspector.

The costs shown below are considered quite low (at least \$1 per ft. less than usual), this being due to a large extent to the *very small* abrasion of the diamonds. This latter is a *most important matter* and the favorable results in this case (the *loss in some holes* being as little as ⅛ carat, and seldom over

$\frac{3}{8}$) was due to the fact that stones were available which had been previously used (and therefore tested), and that the superintendent who set the stones was an expert at this work. With diamonds at \$60 per carat, the importance of properly selected stones, skilful setting and manipulation is apparent.

The following is a summary of the cost:

Wash Borings, 206.8 ft.

	Per ft.
Labor	\$1.34
Engineering17
Total	\$1.51

Diamond Drill Borings, 461 ft.

	Per ft.
Labor	\$4.09
Engineering69
Total	\$4.78

Cost of World's Deepest Diamond Drill Borings. What is claimed to be the world's deepest boring is a hole 7,347 ft. deep drilled in Upper Silesia. The boring as described in *Mines and Minerals* (1912) was undertaken to determine the relation of the coal beds in the Knurow royal mining district, and was conducted by the Prussian Royal Drilling Bureau. The locality of the drilling is 2.1 miles north of Czruchow village. The drill used was a crude combination of the scoop, or wimble, chisel and diamond-bit types, in conjunction with water rinsing. Operations were begun Sept. 25, 1906, but the outfit was not installed until Oct. 15.

The mouth of the hole was 1.44 ft. wide, exclusive of casing, but the diameter gradually diminished to $3\frac{5}{8}$ in. at a depth of 3,214 ft., which also marks the lower limit of casing. From this point down to 5,546 ft. depth the diameter was 0.30 ft.; down to 5,649 ft. the diameter was 0.22 ft.; down to 6,848 ft. the diameter was 0.164 ft.; the remainder of the hole is 0.157 ft. in diameter.

A total of 982 days was consumed in drilling, including 169 Sundays and holidays, and 119 days in accessory operations, as in drill repairing, etc., leaving 694 net working days. The maximum speed attained was a 24-hr. record of 54.87 ft. with the $3\frac{5}{8}$ -in. diamond bit. Altogether 704- $\frac{3}{32}$ carats of diamonds were consumed. The total cost of the drilling was \$77,043, representing an average of \$10.48 per ft.

The list below shows the Prussian drillings exceeding 5,250 ft. in depth, and the cost per foot.

	Depth ft.	Per ft.
Hoetmar	5,320	\$ 5.47
Schladebach	5,734	8.50
Ottweiler	5,915	5.21

	Depth ft.	Per ft.
Everswinkel	5,951	1.23
Paruschowitz V	6,570	2.63
Schubin	7,050	1.80
Csachow	7,347	10.48

The Brejcha System of Diamond Drilling. (See *Engineering and Contracting*, Apr. 26, 1911). This differs from other systems in the setting of the diamonds, in the use of cement grouting instead of casing pipe where it is necessary to support the walls of the hole, and in directing the current of the wash water down around the outside of the drill rods, and up through them, instead of the usual opposite direction. By not using casing pipes, a hole may be almost as small at the start as at the bottom. The wear occurring between fragments of the core is minimized by the inverted flow of wash water. In drilling through cement which has previously been injected in the hole, or through rocks of which no core is desired, the flow of wash water is reversed.

Equipment. The equipment employed in testing for the Rive-de-Gies coal beds in the Saint Etienne basin consists of a derrick 52 ft. high; a shed 54 ft. x 21.0 ft., covering a portable boiler of 15 to 20 hp.; a hoisting drum; pump for injecting water or cement grouting; cement mixer; and the drilling apparatus. The mixer shown by Fig. 69 consisted of a strong iron drum with a covered opening at *B* for the introduction of cement and a shaft, turned by hand, carrying a pair of perforated paddles. By means of the pipe connections shown the water from the pump could pass into the drill rods either through the mixing drum or through the by-pass, the latter being the usual route during drilling.

The boring machine comprised a swivel head, a driving sleeve, a rotating device, drill rods, core barrel and diamond bit. The swivel head, shown by Fig. 70 was designed to support most of the weight on the steel balls, *N*. The dish shaped receptacle catches the overflowing water and sand, discharging them through a pipe at one side. The stuffing box, as shown at the top of the cut, was screwed into place only when it was desired to reverse the flow of the wash water through the rods.

The driving sleeve, shown by Figs. 70 and 71 is 90 mm. ($3\frac{1}{2}$ in.) outside diameter, 7 mm. ($\frac{1}{4}$ in.) and 4.7 m. (15.42 ft.) long, having two projecting feathers or splines diametrically opposite and extending throughout its length. The upper end carried the shoulder *P*, turning on the steel balls, its lower end passing through the rotating device, being driven by the latter through the medium of two splines.

The rotating device is shown by Fig. 71. The outer shell is cast iron. The bottom part is embedded in concrete, forming a

closure for the top of the drill hole as well as a standard for the machine. The method of transmitting rotation by means of splines up and down through a revolving collar is the same as is commonly adopted by the best known diamond drills in America.

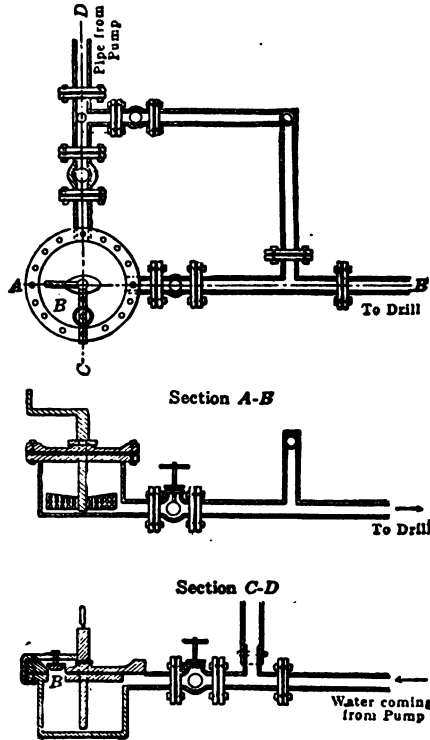

Fig. 69. Cement Mixer for Grouting Shafts.

The drill rods, Fig. 72, were of two sizes, heavy ones being used to start the hole and lighter ones to finish it.

The core barrel and lifter employed by the Brejcha system are practically identical with corresponding parts in the ordinary American method but the diamond bit is wholly different in design and in the method of inserting the stones. The cylindrical bit is made of soft steel, as illustrated by Fig. 73, the outside diameter is 73 mm. ($2\frac{7}{8}$ in.), the inside diameter is 53 mm. ($2\frac{1}{16}$ in.), leaving $\frac{13}{32}$ in. of metal in the wall. Four

rounded grooves are cut vertically on both outside and inside surfaces to allow free circulation of water. Bored upward in

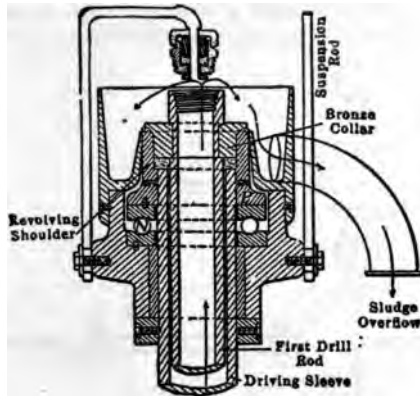

Fig. 70. Swivel Head for Drilling Machine.

the lower edge of the bit are 14 holes of 6.7 mm. ($\frac{1}{4}$ in.) diameter, tapering at their upper ends, and so inclined as to

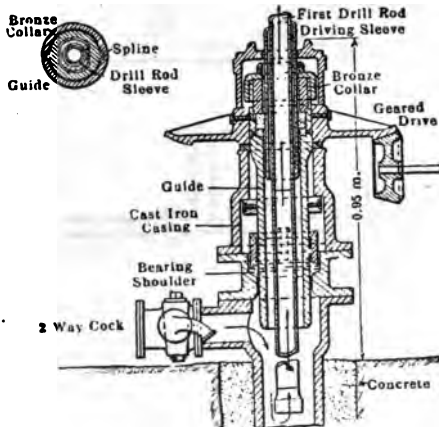

Fig. 71. Rotating Mechanism for Drilling Machine.

break through the outer or inner wall of the cylinder, in a small aperture. Four other similar holes are bored inward from the

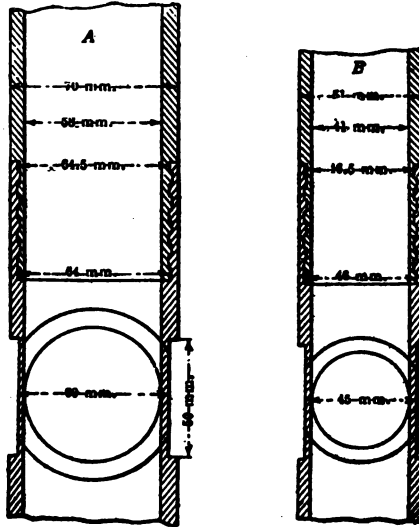

Fig. 72. Sections of Drill Rods.

outer wall surface and two more, outward from the inside surface, making provision for 20 diamonds so placed with respect to one another as to cover the surface to be ground completely as they rotate.

The diamonds are not bedded directly in the steel of the bit but are fixed in little conical shaped pieces of steel which are fitted as chucks into the holes in the bit. This method is thought to permit a more rapid exchange of stones and to reduce the wear on both stones and bit. The little steel plugs carrying the worn diamonds are simply forced out of their sockets by driving a steel pin through the small apertures for that purpose, and other plugs previously fitted with fresh diamonds, are inserted in their places.

To fit the stones in the little steel plugs, a shallow hole is drilled in one side near one end. This bar is laid on a special anvil, the hole filled with solder which is heated until it melts, and the diamond forced into the solder by a quick but careful stroke of a lever. The bar is then immediately cooled in water.

Three forms of diamonds were tried, carbonados, bortz and balas stones. Carbonados, being angular, were found unsuitable for this particular work, although they might serve for boring in fine grained, uniform rocks; they cost about \$19.30 per carat.

Bortz are rounded, but as they consist of an aggregate of minute crystals, cleavage soon developed and the stones broke while boring in rocks of irregular texture; as they cost only \$3.47 to \$3.86 per carat, they were quite commonly used. Balas stones, being round and homogeneous, gave the best satisfaction; they cost about \$58 per carat. The consumption of diamonds was exceedingly variable. For the first 600 m. it averaged only \$5.40 per meter, then rose for a short distance, while traversing a fis-

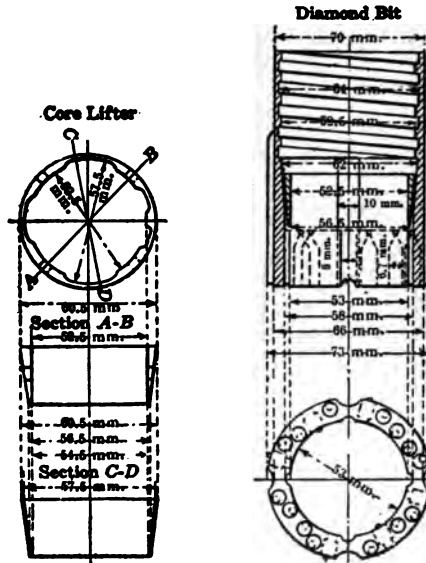

Fig. 73. Core Lifter and Diamond Bit.

sured zone, to \$96 per meter; the average for the whole 1,152 m. was about \$11.58 per meter.

Registering Device. To avoid the possibility of passing through a coal seam without noticing the fact by failure to observe the color of the sludge, an automatic device was constructed for recording the progress of the rods.

This consisted of a pencil registering on paper, and actuated by a cord passing over pulley and fastened to the head of the drill. The average speed in sandstone was 2 ft. per hr., and in coal, 16.5 ft. per hr.

The volume of water needed was 176 cu. ft. per hr.

The actual boring operations were conducted in much the same

way as is usual in America and elsewhere with other types of diamond drill. Drill rods were hoisted and lowered, and the feed of the rods through the driving sleeve was arranged in precisely the same way as with ordinary drills. Before breaking off the core, the water current was stopped for a moment so as to allow the suspended sand to settle down around the core, assisting the action of the core lifter, and protecting the core somewhat from breakage during its journey to the top. On lowering the rods, they were always stopped at least 1 m. from the bottom, wash water was circulated for at least half an hour, and the rods were rotated while gradually being lowered into position to continue cutting. Hoisting, washing and lowering to the bottom of the hole, 1,150 m. (3,772 ft.), occupied 9 hr.

Cementing Process. A distinctive feature of the Brejcha method is the use of cement grouting to take the place of casing pipes through fissured or watery zones. The treatment of strongly fissured, porous rock differs from that required for passing through more compact rock in which the fissures, with or without water, are more isolated.

In the first case, injection of cement can go on without stopping the boring, by simply switching the flow of wash water into and through the cement mixer, as indicated by Fig. 70. Two sacks of screened cement are poured into the mixer, with some water, and the crank is turned until the grout is thoroughly mixed. The valve leading to the drill is then slowly opened, allowing the grout to mingle with the wash water. As the fluid cement passes down along the wall of the hole, under increasing pressure, it naturally penetrates into any open fissures and solidifies there. If the fissures are so large and numerous as to require a continuous flow of grout, two mixers may be installed in parallel pipe lines, so that the mixtures can be made alternately and fed into the hole without interruption.

In dealing with more compact rocks, but with larger cavities or fissures, several cases may arise. If it is only a cavity, without a flow of water, some quick setting cement is made up into a conical, sausage shaped plug, and lowered into the hole. If the plug does not stop and expand by itself at the right spot, it should be made slightly larger than the hole; on pushing it down with the drill rods it can then be stopped at any desired point. A small amount of grout is then poured on top of the plug, and time is allowed for it to set. Then enough grout is poured in through the drill rods to solidify the cavity, the rods being slowly withdrawn as the cavity fills. After 36 hr. it will usually be safe to resume drilling in the ordinary way. A speed of 80 ft. per hr. can readily be maintained through the cement plug. *While drilling through cement, it is a good plan to*



Fig. 74. Class "F-1" "Calyx" Drill.

force the wash water down inside the rods instead of up, with the object of disintegrating the core as much as possible, and thus avoid the necessity of hoisting the rods with the usual frequency, to no useful purpose. It is an obvious advantage to use the quickest setting cement available.

In case an inrush of material is met at or below a cavity, boring is continued past the fissure, and cement is then forced by the pump down through the rods and up between them and the sides of the hole in the running material. On drawing the rods up slowly, while continuing to feed cement, the hole can be solidly filled up to a point above the cavity. If a fissure should be met which drains water out of the hole, cement may be forced down the rods under heavy pump pressure, so as to cause it to penetrate as far as possible into the fissure before setting. In these two last mentioned cases, three or four days should be allowed for the cement to set before resuming boring.

Shot Drills. This type of core drill consists essentially of a cutter or bit; a core barrel, which is a tube carrying the bit and having the same external diameter; a drill rod, which screws into the reducing plug at the upper end of the core barrel and extends to the driving mechanism at the surface; a sludge receiver or cylinder, which is a tube of the same diameter as the core barrel and which extends from the reducing plug upward; and a driving and operating machine at the surface.

In operation, the drill rods, sludge cylinder, core barrel and bit are rotated, while water is pumped through the hollow drill rod into the core barrel. The water passes from the core barrel under the bit and up through the space left around the core barrel by the clearance of the bit, washing out the sludge and cuttings. At the top of the sludge receiver, the velocity of the water decreases because of the larger cross-section, and the heavier cuttings drop into the receiver. As the bit penetrates, a cylinder or core is left in the core barrel. When the core barrel is almost full this core is broken off as described later.

Shot Required. The quantity of shot varies with the nature of the material through which the hole is being driven, and with the method of feeding the shot. With the "Calyx" drill, in which the shot is fed slowly, a few at a time through a special water feed pipe, about 0.25 to 0.75 lb. per ft. of hole are required in shale, slate, limestone and ordinary sandstone, and from 1.5 to 4 lb. per ft. in very hard sandstone, granite, quartz, conglomerate, porphyry, taconite and jasper. With drills which do not employ a feeding device, and in which the shot is thrown down the drive pipe, some of the steel is wasted. The McKiernan-Terry Drill Co. state that the average cost of shot on prospecting holes runs about 2 or 3 ct. per ft. The average shot bit



Fig. 75. Davis Cutter
Used on the "Calyx"
Drill.

will drill about 75 to 100 ft. of rods and will cost 4 to 5 ct. per ft. of drilling. In drilling a well on State St., New York City, with a Dobbins core drill, in 1912, through gneiss (containing a large amount of quartz), about one pound of chilled steel shot was used for each foot drilled. Cores measured 6 in. in diameter, and the well was drilled to a depth of 800 ft.

Chilled shot is produced by atomizing molten iron or steel and suddenly chilling the small particles thus produced. The resulting material is so hard that it will scratch glass. The chilled metal varies from a powder so fine that it can be blown from the hand with a breath, up to particles as large as a buck shot. The largest may be $\frac{3}{8}$ in. in diameter, but the average drilling size is about $\frac{3}{32}$ in.

Chilled shot has been used for years for sawing and polishing stone, but its use for core drilling is of more recent date. Another material sometimes used is crushed steel, variously sold under such names as "diamondite," "abrasite," etc. While ordinarily it is inferior to chilled shot, and does not give such satisfactory results, yet for comparatively soft formations it is sometimes better than shot.

Sizes of Shot Drills. With shot drills, holes ranging from 2 in. to 2 or 3 ft. in diameter may be drilled. Table XLII gives the sizes and general characteristics of McKiernan-Terry Shot Core drills.

TABLE XLII. TYPES AND RATED CAPACITIES OF M'KIERNAN-TERRY SHOT CORE DRILLS

Catalog No.	Z-1	A A-3	B B-3	C C-3
Size of tools, in.	2-2 $\frac{3}{4}$	2 $\frac{3}{4}$ -5	2 $\frac{3}{4}$ -7 $\frac{1}{2}$	3 $\frac{3}{4}$ -18
Diam. of hole, in.	2 $\frac{1}{4}$ -3	3-5 $\frac{1}{4}$	3-8	4-18 $\frac{1}{2}$
Diam. of core, in.	1 $\frac{1}{4}$ -1 $\frac{3}{4}$	1 $\frac{3}{4}$ -4	1 $\frac{3}{4}$ -6 $\frac{1}{2}$	2 $\frac{3}{4}$ -16 $\frac{3}{4}$
Depth of hole, ft.	400	250-750	800-1500	400-4000
Hp. of boiler	5	10 ..	20 ..	40 ..
Hp. of drive	4	4 8	12 15	25 30
Power used	S, G, E	S, A, G, E	S, A, G, E	S, A, G, E
Net price equipped to drill 100 ft.	\$750	\$1,287	\$2,000	\$3,500
Net price of extra rods, per 10-ft. length	\$6.00	\$7.00	\$8.50	\$11.50

NOTE: S indicates steam power, A compressed air, G gasoline, E electricity.

The Davis Cutter. When drilling in soft or moderately hard material with the "Calyx" drill, this cutter, shown in Fig. 75, may be employed. This device does not cut or wear away the rock but clips it off. The speed of rotation is much less with the cutter than with the shot bit, and the "Calyx" machine is therefore arranged to give two speeds.

Spudding. In order to get down through tough coarse gravel, loose stones, or boulders, a spudding device (Fig. 76) is almost essential. Chopping bits, sometimes with hollow centers to provide water-ways, are screwed to the lower end of the drill rods, and the rods and bits are then worked up and down, using the same process as when driving the stand pipe, as described on pages 261, 338, 382. In some machines a special spudding device is provided. When the overlying soft material is of great depth, it is usually economical to have a well drilling or other type of wash-boring machine for boring through this soft material.

Double Core Barrel. Where the material is soft and friable, and apt to disintegrate, cores of proper size are very difficult to obtain, and are usually very much shorter than the length of the hole from which they are obtained. A double core barrel, consisting of an outer and inner cylinder the latter being non-rotating, is used with the Calyx drill in this kind of material. The inner cylinder protects the soft rock from attrition and permits the withdrawal of a more perfect core.

Speed and Cost of Shot Drilling. In schist and quartz, in the Porcupine district, Ontario, with a class "A" McKiernan-Terry shot drill, producing a $2\frac{3}{4}$ -in. core, the speed of driving at an average angle of $38\frac{1}{2}$ deg. from the vertical was 18 ft. per day of 9 hr., at a cost of \$1.50 per ft. In hard quartz at an angle of 40 deg., 100 ft. cost \$2.56 per ft. In the same district 517 ft. cost \$2.00 per ft. The average speed was 23 ft. per day. In seewatin, diabase, calcite and quartz at a mine in Cobalt, 304 ft. of $2\frac{3}{4}$ -in. core was obtained at a cost of \$2.27 per ft., the average speed being 7 ft. per 10-hr. shift. In gneiss and feldspar, a class Z-1 drill, producing a $1\frac{1}{4}$ -in. core, made 15 ft. in 9 hr.

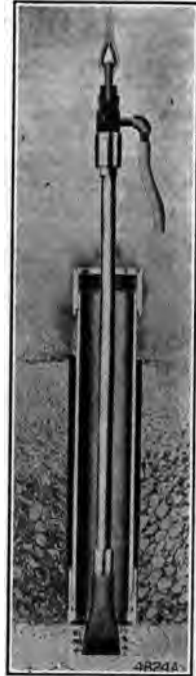

Fig. 76. Spudding with Chopping Bit, with Water Jet Attached.

at a cost of 62 ct. per ft. In highly crystallized lime rock in a zinc property in Virginia, the speed of drilling holes several hundred feet deep averaged 12 ft. per day at a cost of \$2.00 per ft.

In drilling 10-in holes, with 8½-in. cores for an artesian well 2,000 ft. deep in Astoria, L. I., casing was used from the surface to bed-rock, a distance of 52 ft. The rock was hard granite badly broken in many places. The average progress per shift was 9 ft. The labor cost was \$11 per day and the total cost including labor, fuel, and replacement charges was \$5.50 per ft.



A
Drive Shoe

B
Solid Drive Head

C
Hollow Drive Head

Fig. 77.

Mr. F. W. Samson (*Engineering and Contracting*, May 7, 1911) gives the following data regarding core drilling in limestones and flint in prospecting from the 240-ft. level of a zinc mine in the Joplin, Mo., district. The drill used was a "Calyx" "F-1," boring a hole 4¼ in. in diameter, and producing a 3½-in. core. It had a capacity of 800 ft. The speed ranged from 2 to 3 ft. per 8-hr. day in hard flint to 15 or 17 ft. in limestones. The cores had to be removed frequently because, due to the fissured character of the rock, they broke in small pieces and had a tendency to grind up. The derricks used were necessarily low and the time required for taking out cores and removing rods was at least one-third the working time.

Directions for Operating Shot Drills. Have sufficient casing to reach to rock, and of proper diameter in 5 ft. lengths, with some 2 ft. lengths. Extra strong pipe must be used in all cases except where soil is light and free from boulders, in which case standard weight pipe may be used. Screw the drive shoe (Fig. 77A) on one end of a 5-ft. length of casing, and attach coupling and drive head (Fig. 77B) to the other end. Plumb the casing with a level or plumb-line, and start driving until the head is level with the ground. Take off the drive head and connect chopping bit (Fig. 77D) to sufficient length of drill rods to reach below the bottom of the driven casing. Connect hoisting and plug to upper end of the drill rods. Churn up and



D
Chopping Bit

E
Supporting Fork

F
Shot Bit

Fig. 77.

down, at the same time pumping through the rods, and the soil will soon wash out.

When boulders are encountered use the drill tools. Coat all threads heavily with grease. Screw the slotted shot bit (Fig. 77F) into the core barrel and the core barrel into the core barrel plug (Fig. 79-B). Screw, to the upper end of the plug, the drill rod and a sludge receiver, sliding the sludge receiver over



Fig. 78.

Section Showing
Core Drill Rod,
etc.

the drill rod. Throw a handful of shot into the drive-pipe and one over the tools into the hole. Connect the drill rod to the spindle by means of the coupling. Adjust the pumps so that the water will just gently overflow the top of the casing. Too much water will wash the shot from under the bit and too little will permit the sludge to accumulate at the bottom of the hole. Start the drill and apply pressure with the feeding device. When the rate of progress begins to diminish, supply more shot through the shot feed. After the boulder has been passed, secure the casing clamp (Fig. 80-B) to the drive pipe and raise it up with the jacks 3 or 4 ft. Lower a charge of dynamite into the hole and fire it.

To remove the core, first wash out all the sludge until the waste water runs clear. Then stop the pump, raise the spindle a short distance and pour into the drill rods a handful of "grout," or gravel, or small crushed stone. For cores up to 3 in. diameter the grout should be $\frac{1}{16}$ to $\frac{3}{16}$ in. diameter. Again couple the spindle, start the pump and revolve the drill rods a few times. This will wedge the core in the barrel and break it off. Disconnect the drill rods from the spindle and screw the hoisting plug (Fig. 80C) with its line attached into the drill rod coupling and hoist the rods. The rods in the hole are held up by the supporting fork (Fig. 77E) while the upper lengths are being removed.

The successful operation of the drill depends on the proper amount of water being supplied, the proper pressure applied to the bit, and the proper feeding of the shot. The waterway opening in the bottom of the bit should be cut back as the bit wears down. A bit should last, depending on the rock, for from 15 to 50 ft. of drilling. The quantity of shot fed to the bit should be enough to cover the bottom of the annular ring it is cutting. This cutting is caused by the breaking of the shot, which, being of chilled steel and very hard, imbeds itself in the softer material of the bit. This produces minute pockets in which the particles of shot are constantly caught and dropped each time, presenting a *new facet* which cuts away the rock.

When water-bearing seams are encountered and the flow is sufficient to wash the shot from under the bit, one method of

remedying the trouble is by dropping balls of soft clay into the hole, and tamping it into the seams by means of a wooden plug fitted into the core barrel. Another method is by pouring cement down the hole and allowing it to harden.

When crevices and broken rock are encountered, very little water and a large amount of shot fed almost continually are

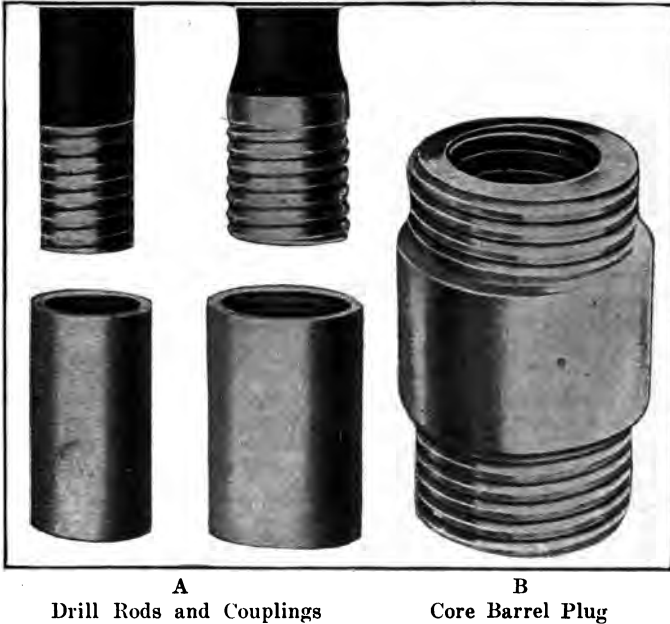

A
Drill Rods and Couplings

B
Core Barrel Plug

Fig. 79.

required. In this way it is possible for a careful operator to keep shot under the bit even when drilling through a vertical crevice.

Cost of Drilling, N. Y. City. In putting down a number of test holes in New York City with McKiernan-Terry core drills, the rate of progress ranged from 5 to 20 ft. per shift. This included both the pipe driving through the overburden of earth and the rock drilling. The cost on the pipe driving work ran from 90 ct. to \$4 per ft., due to encountering numerous boulders which had to be blasted. The rock drilling cost from \$1.50 up to \$6.50 per ft., the average being about \$2.75. The average for the total work, including both earth and rock, was about \$2.50 per ft. This is somewhat more expensive than it would be on

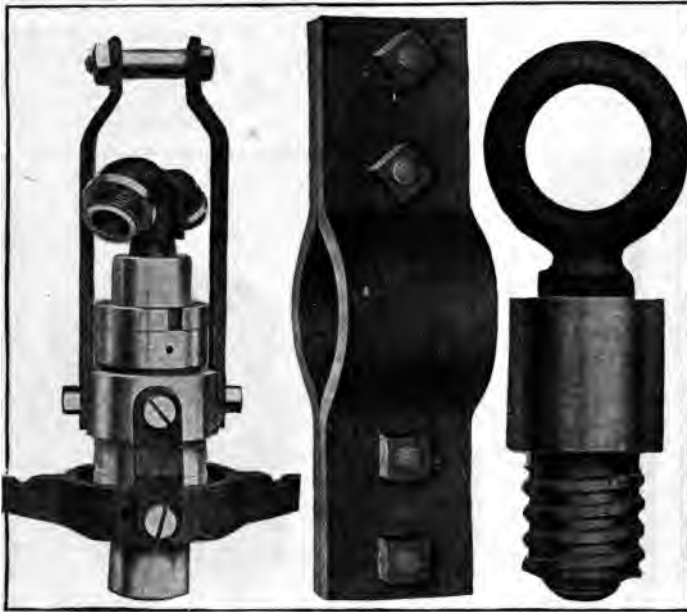

A
Water Swivel

B
Casing Clamp

C
Hoisting Plug

Fig. 80.

ordinary prospecting work, as it was necessary to include in these costs a licensed engineer and a night watchman.

In another instance, on four prospect holes put down in a slate rock, with clay seams, the average cost per ft. was \$2.52. This included the moving of the drill, the hauling of coal for a considerable distance, and drilling expenses, together with the board of a driller and fireman. In Canada, the cost on a number of holes drilled with a shot drill ran about \$1.34 per ft. This also included all of the expenses, such as coal, moving, etc.

Use of a Terry Shot Drill in New Jersey. The Plainfield Mining Co., Plainfield, N. J., gives the following details concerning the drilling of a 235-ft. hole with Class-A Terry core drill in 1910. The earth over-burden was 4 ft.

The work was carried on under disadvantageous conditions, it being necessary to haul not only fuel but also water to the drill, these items increasing the daily charges \$4. Even under these conditions, the actual cost was less than \$1.00 per ft. Two men operated the drill working 9 hr. per day.



Fig. 81. Recovering Taps.

The tools used were the regular $3\frac{1}{4}$ -in. drill, which cut a 4-in. hole, and removed a $2\frac{3}{8}$ -in. core. No close record of the percentage of core recovered was kept, since the company was not interested in the quality of slate overlying the ore. But in the last day's run, from the 14 ft. drilled, 13 ft. of ore were obtained.

The machine was fitted on a mounted rig and could be moved without disconnecting the drill from the boiler. This facilitated moving from hole to hole.

Use of a Shot Drill in Prospecting for Coal. From an article by Mr. S. H. Painter in *Compressed Air Magazine*, the following information relative to prospect drilling in Routt, Colorado, is derived.

The drill used was a Calyx "B F I" 1,500 ft. capacity, equipped with a 38 ft. sectional steel derrick, allowing 30 ft. sections of rods to be pulled at a time, and 6 in. drilling tools giving cores 5 in. in diameter. Had a 58-ft. derrick been used better progress would have been made, as most of the holes were over 1,000 ft. deep.

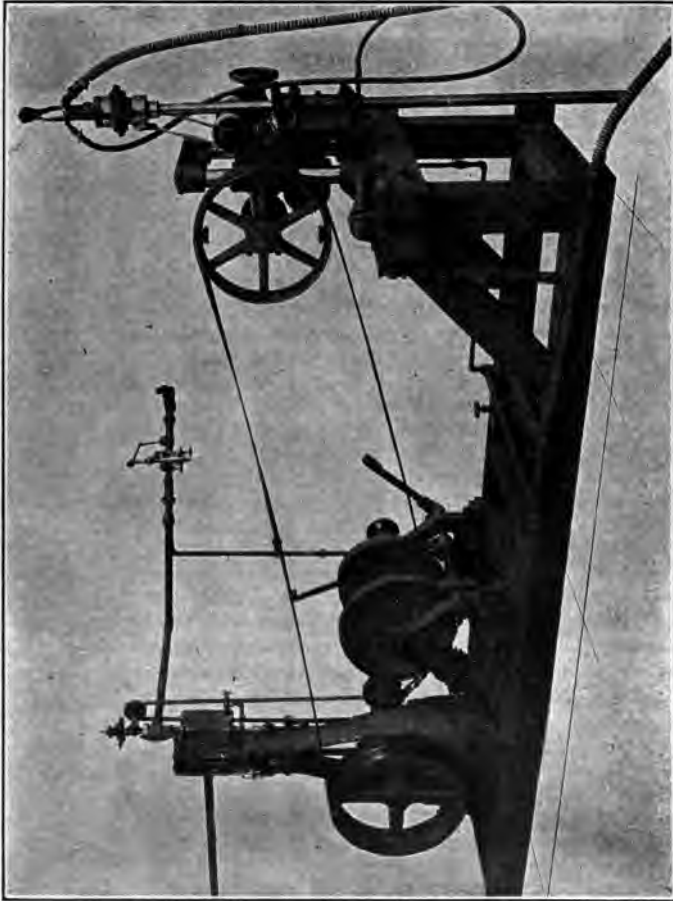

Fig. 82. A Class "F" Steam Driven "Calyx" Drill Outfit, with Drill, Engine and Hoist.

The drill was guaranteed to drive the first hole 600 ft. with 6-in. tools at not less than 9 ft. per hr.

In 33 shifts 600 ft. of hole was drilled, or 18 ft. per shift. The maximum rate was 33 ft. and the minimum 12 ft. per shift. The formation was sandstone, slate, shale and limestone.

The average cost was \$0.72 per ft. for the first 600 ft. of hole.

The hole was continued to 1,250 ft. but at a lower cost per ft. The daily operating cost was:

Head driller	\$ 5.00
Helper	3.50
Helper	2.50
Chilled shot15
Shot bit20
Coal (\$4.50 per ton)	1.50
Lubricating oil, etc.10
Total per day	\$12.95

Cost of Drilling Concrete. Shot drills will penetrate almost any kind of material except that which is so soft as to permit the shot to bed itself instead of rolling. In boring holes, 29 in. diameter, at an angle of 55 deg. from the vertical, in a concrete wall (trap rock aggregate) in which steel beams and iron drain pipes were encountered, the progress, according to Capt. H. L. Wigmore of the War Department, under whose direction the work was performed, was as follows:

Date.	Depth drill, inches.	Net drilling time	
		hours.	minutes.
April 18	37	2	40
April 19	36	1	0
April 20	31	2	0
8-in. I-beam cut through.			
April 22	33 ½	1	15
2-in. wrought iron pipe cut through.			
Totals	137 ½	6	55

This gives 11.5 ft. in 4 days, an average at almost 3 ft. per day, which compares favorably with the speed obtained in drilling very small core holes in hard material. It would seem that the size of hole does not affect the speed of drilling provided machines of sufficient power are used. In the foregoing work the head room was limited which materially delayed the work of removing cores.

For drilling the holes it is estimated that in cutting 14 ft. of hole the wear of the bit was \$5.25 and the consumption of oil, waste, grease and shot \$2, making the total cost for 14 ft. \$7.25. In cutting a similar hole only 6 ft. in length the total cost was estimated at \$7, divided between wear on the bit, valued at \$6, and consumption of shot, oil, waste, etc., at \$1. The total cost for drilling 20 ft. of hole is, therefore, \$14.25. The costs are exclusive of labor.

Comparison of Cost of Shot and Diamond Drilling in Nova Scotia. The following table gives the cost of drilling with steam driven Calyx shot drills giving a 6-in. core, and the cost with a steam driven Sullivan diamond drill giving 15/16 and 2-in. cores, and with a hand operated diamond drill giving a 15/16 in. core, all owned and operated by the Department of Mines of Nova Scotia during the year 1908, 1909 and 1910. The Table has been

condensed from articles in *Engineering and Contracting*, July 28, 1909 and Oct. 11, 1911.

	1907	1908	1909	1910
Footage of all drills	6,273	7,905	5,576	5,222
Footage by diamond drills		2,962	3,378	4,498
Footage by Calyx drills		3,412	2,198	724
Cost per ft., all boring	\$1.28	\$1.06	\$1.405	\$0.99
Cost per ft., diamond drills	0.73	0.845	0.79	0.93
Cost per ft., Calyx drills	1.71	1.34	2.166	1.44
Diamond cost per ft.	0.013	0.077	0.037	0.067
Shot cost per ft. (Calyx)	0.47	0.056	0.055	0.02

The costs do not include interest and depreciation.

Diamond Drilling. The diamond cost on drilling 6,340 ft. during 1908 and 1909 averaged about \$0.057 per ft. drilled, which is almost the same as the cost of shot in drilling 5,610 ft. during the same years, which averaged about \$0.056 per ft. The cost of diamond and shot consumption varies considerably when compared hole by hole. The average cost of diamond drilling a 15/16-in. core was \$0.716; of drilling a 2-in. core, \$0.799 (neglecting an abandoned hole), and of obtaining a 15/16-in. core with the hand diamond drill it was \$1.07 per ft. Bits and core barrels in diamond drilling cost 1 to 6 ct. per ft. of hole, averaging about 2.5 ct. Fuel cost 1 to 15 ct. per ft. of hole, averaging about 6 ct.

Comparative Costs of Wash Borings and Shot Drilling. In determining the location of locks on the Ohio River Improvement, Calyx, "G 4" and "F" type, shot drills and Cyclone "No. 4" type cable drills were used in driving holes about 30 ft. deep. The following data concerning the outfit and the cost of operation was compiled from a paper by Capt. Lytle Brown, Corps of Engineers, U. S. A. (*Engineering and Contracting*, July 26, 1911.)

- 1 chief of party.
 - 1 drill foreman.
 - 1 clerk (timekeeper, subsistence clerk and property man).
 - 1 instrument man (locating holes).
 - 2 skiff men.
 - 1 night watchman.
 - 1 cook.
 - 2 cook's helpers (waiters and quarter boat police).
 - 6 drill crews: 1 recorder, 1 engine man, 1 fireman, 1 laborer.
 - 1 steamboat crew: 1 pilot, 1 engineer, 1 fireman, 1 deck hand.
- The general equipment of the party was:
- 1 quarter boat, 6 drill boats: 2 with Ingersoll-Rand core drills, 4 with Cyclone spudding drills.
 - 1 steamboat (for placing drills, and general towing of the entire outfit).
 - 1 full flat, 8 skiffs.

The steamboat should have enough power to handle the whole outfit, but should be a quick and good handler for placing single boats. A boat of about 20 x 100 ft., with 10-in. cylinders and 4-ft. stroke should be good. The boats used had a little less power. A complete outfit for one Ingersoll-Rand drill consisted of:

CORE DRILLS

361

TABLE XLIII. COST OF SHOT CALYX DRILLING (6 IN. CORE)

Hole	Drill No.	Depth of hole, ft.	Material	Average ft. per hr.	Max. ft. per hr.	Total cost per ft.	Cost per ft., Dollars									
							S. Sh.	C. Sh.	Management	Labor, Incl. Pnl. & Truck	Fuel, light, oil, waste, etc.	Shot, gravel, carbon	Lumber	Bits, Core barrels, etc.	Repairs to casing pipe or engine.	
A	1	769	S. Sh.	0.6	3.0	\$1.328	0.313	0.062	0.231	0.076	0.040	0.040	0.013	0.006	0.018	
B	1	1170	" "	0.6	3.0	1.539	0.282	0.849	0.178	0.062	0.013	0.062	0.013	0.006	0.018	
C	1	347	Sh. S.	0.7	5.8	1.865	0.492	0.789	0.439	0.025	0.048	0.021	0.012	0.040	0.024	
D	1	424	C. Measures	2.3	6.5	1.296	0.353	0.091	0.097	0.049	0.016	0.016	0.012	0.040	0.024	
E	5	208	" "	1.0	5.8	0.986	0.158	0.612	0.081	0.053	0.058	0.019	0.012	0.040	0.024	
F	5	367	" "	0.9	8.0	1.129	0.204	0.741	0.070	0.073	0.022	0.019	0.012	0.040	0.024	
G	5	502	" "	1.2	8.0	0.924	0.143	0.500	0.051	0.029	0.013	0.029	0.012	0.040	0.024	
H	5	1102	Sh. S.	1.0	5.8	1.350	0.245	0.184	0.184	0.064	0.008	0.068	0.012	0.040	0.024	
I	6	470	Hard S. Sh.	1.0	4.0	2.272	0.199	0.190	0.190	0.085	0.174	0.170	0.012	0.040	0.024	
J	6	851	Sh., S. C.	0.4	7.6	3.991	0.425	0.889	0.689	0.046	0.159	0.227	0.012	0.040	0.024	
K	5	559	Sh., S. C.	..	6.5	1.426	0.355	0.331	0.024	0.024	0.080	0.020	0.012	0.040	0.024	

Note: S is sandstone; Sh. is shale; C is coal.

One "G4" rotary drill for drilling 3¼-in. holes and cutting 2½-in. cores; with sensitive feed, speed changing device for driving either Davis cutters or shot bits at proper speed, and hinges for swinging drill aside for driving pipe. Cut gears and bronze bushings throughout.

One No. 1 friction drum hoist with foot lever, brake, ratchet and pawl and winch head.

One 5 hp. vertical steam engine, single cylinder, with governor, sight feed lubricators, drain cocks, oil cups, throttle valve and wrenches. Drill hoist and engine mounted on substantial wooden frame with the necessary belt sprockets and chain, for connecting engine with drill and hoist.

One 8 hp. vertical boiler, with smokestack, grate, pop safety valve, steam gage, gage cocks, injector, and cast-iron boiler base.

One Canton duplex steam pump, 4½-in. steam and 3-in. water cylinder, 4-in. stroke, with grout cock, foot valve and strainer.

- 1 water swivel.
- 2 hoisting swivels.
- 4 Davis cutters.
- 1 supporting fork.
- 1 drive weight and jars.
- 50 pounds grout.
- 2 fishing taps.
- 1 shot feed.
- 1 spanner wrench.
- 4 shot bits.
- 4 chopping bits.
- 1 pair casing clamps.
- 1 safety shackles.
- 1 drill spindle.
- 1 core barrel, 8 ft.
- 1 core barrel, 4 ft.
- 1 core barrel, 2 ft.
- 200 pounds chilled shot.
- 1 socket wrench.
- 5 drill rods, 18 ins. long.
- 2 drill rods, 5 ft. long.
- 4 drill rods, 10 ft. long.
- 1 set matched couplings.
- 1 pressure rope.
- 1 gouge.
- 1 flatter.
- 1 dressing plate.
- 1 10-in. steel pulley.
- 75 ft. ¾-in. wire line.
- 150 ft. 1 in. manila line.
- 1 triple block, 1 in. line.
- 1 double block, 1 in. line.
- 1 anvil.
- 1 combination vise.
- 1 forge.
- 1 hot chisel.
- 1 cold chisel.
- 1 pair Smith's tongs.
- 1 hammer bale bean.
- 1 monkey wrench, 12 in.
- 1 Stillson wrench, 24 in.
- 2 chain pipe wrenches, No. 13.
- 6 10-ft. lengths XX drive-well pipe and couplings.
- 6 5-ft. lengths XX drive-well pipe and couplings.
- 5 2-ft. lengths XX drive-well pipe and couplings.
- 1 3½-in. drive head (steel).
- 2 3½-in. drive shoes (steel).
- 1 firing hoe.
- 1 slicer.
- 1 flue cleaner.
- 1 shovel.
- 10 ft. hose for shot feed.
- 15 ft. hose for water swivel.

And the necessary piping for water and steam connections.

When the force was increased for the 1910 season "F" ma-

chines were bought instead of the "G4"; these are heavier machines and better adapted to the rough work to which they were subjected. These machines were provided with a special spudding device which proved to be of little value.

A complete outfit for one Cyclone cable drill consisted of the following:

- 1 No. 4 steam drill fitted with Cyclone positive clutch, mounted with engine on three sills.
- 1 7-hp. vertical engine.
- 1 27-ft. A-frame with crown and sand line pulleys.
- 1 12-hp. vertical boiler on cast-iron base.
- 1 Canton duplex pump, 5 1/2-in. steam cylinder, 3 1/2-in. water cylinder, 5-in. stroke with fittings and connections.
- 60 ft. of 2-in. XX, and 1 1/2-in. XX drill rods.
- 120 ft. 3 1/2-in. XX drive-well pipe in 5 and 10-ft. lengths, with couplings.
- 1 drill head.
- 2 drive shoes.
- 1 300-lb. drive-weight, with wrenches.
- 1 pair drill handles.
- 2 No. 12 Vulcan tongs.
- 1 grab hook.
- 1 smith's hammer.
- 1 3-in. bit gage.
- 1 cold chisel.
- 1 14-in. file.
- 1 handsaw.
- 1 axe.
- 1 rope hook.
- 1 rope bolt.
- 150 ft. 1 1/2-in. mill hose for shore drill.
- 1 jetting head.
- 1 set steel drive clamps.
- 2 3-in. rock bits.
- 1 driver stem.
- 1 driver stem eye.
- 2 tool wrenches.
- 1 foot wrench.
- 1 1 1/2-in. taper taps.
- 1 oil can.
- 1 belt punch.
- 1 20-ft. length 1 1/2-in. armored hose.
- 1 suction pipe and pump strainer.
- 1 ball-bearing packing box and stem, with swivel.
- 18 ft. discharge hose.
- 1 14-in. monkey wrench.

The unit costs of the work were kept in detail, and for the season of 1909 were as follows:

Wash Borings, Preliminary:	Per Ft.
Labor	\$0.278
Subsistence	0.098
Fuel, oil, etc.	0.041
Repairs	0.084
Towing, lost time, etc.	0.485
<hr/>	
Total per ft.	\$0.936
Wash Borings, Final:	Per Ft.
Labor	\$0.201
Subsistence	0.102
Fuel, oil, etc.	0.051
Repairs	0.036
Towing, lost time, etc.	0.566
<hr/>	
Total per ft.	\$0.956

Core Borings, Shot:	Per. Ft.
Labor	\$0.628
Subsistence	0.262
Fuel, oil, etc.	0.146
Repairs	0.101
Towing, lost time, etc.	1.540
Total per ft.	\$2.677

The governing item in these costs seems to be that of towing, lost time, etc. This is due to the special conditions of the case. The moving of the outfit, especially upstream, was very expensive, owing to the great difficulty of navigation on the Upper Ohio at the low stages of the river. While the party and outfit was being slowly pushed upstream expenses were not reduced, but augmented, and no work was done. In any case where no great moving has to be done, the cost of the work can be materially reduced from the figures given above.

In comparing the above costs, it is well to remember that most of the work was in coarse gravel and sand where the core machines were delayed due to the difficulty of driving casing pipe with these machines. The cores were taken in limestone, sandstone and shale and were seldom over 2 ft. long. An important point favor of the shot drill was the reliability of its cores when compared with those of the ~~shot~~ ~~drill~~, whose records were often worthless.

Diamond Drilling and Hydraulic Testing of Seaminess of Rock, Ashokan Dam Site. (*Engineering and Contracting*, June 23, 1909.) Wash boring and diamond drilling were used to test the site of the Ashokan Dam in the Catskill Mts. The methods and results of the wash boring are given in my "Handbook of Earth Excavation." The following relates to the diamond drilling and to the testing of the holes, by hydraulic pressure.

Some of the work was done by the Board of Water Supply of New York City and some by a contractor.

When bed-rock was reached, the casing was well "seated," and the screw feed attached to the drill. The diamond bit with core shell and core lifter were adjusted to the core barrel. These were placed in the hole and a sufficient number of hollow drill rods attached to bring the bit in contact with rock; 10 or 15 ft. of rods at the upper end were placed through the hollow drill spindle of the screw feed, screwed to the rods in the hole, and clamped.

Between the diamond bit and the core barrel in the core shell is a "core lifter." This device is a split ring through which the core must pass before entering the core barrel. The latter retains the core when the rods are pulled up, due to the reduction in diameter produced by the downward pressure of the core. A drill runner, in order to be sure that the core is in the barrel,

will "block" the bit, that is, he will break off the core so that it will enter the core barrel and so exert a downward pressure on the core lifter. This is accomplished by running the machine at its full capacity until it suddenly stops or "plugs"; or the flow of water may be stopped and the core broken by the heat generated by the diamond bit. The choice of method used depends upon the character of the rock encountered. In very soft rock it is next to impossible to make large runs without "blocking." In this event the rods must be pulled up frequently and the core removed in order that the drilling may proceed. The size of bit used varied with the casing. With the larger casing an "A" bit giving a core $1\frac{1}{8}$ in. in diameter, was used, but when the $1\frac{5}{16}$ -in. casing was employed, the E bit giving a $1\frac{15}{16}$ -in. core was required.

Owing to the lack of experienced drill runners, the screw feed only was used on the machines operated by the Board of Water Supply. After a man has worked for six months on one of these rigs, he should be competent to run the drill. With the screw feed there is a positive rate of advance, that is, it requires so many revolutions of the rods to advance a certain distance, irrespective of the quality of the rock. When an open seam was encountered, the machine would "race" until rock was again reached. Where greater progress was desired in the rock, the steam was increased, resulting in a greater number of revolutions of the bit per minute. On the counter-shaft was a friction device which allowed reversal of the feed and acted as a safeguard against any sudden jar to the diamond bit.

Hydraulic feed was used on the machines employed by the contractor. The amount of water admitted or released from the hydraulic cylinder is fully controlled by adjusting the valves, thus giving an unlimited range of feed, which is of great value to an experienced drill runner. The hydraulic feed apparatus is entirely independent of the engine, and the feed may be regulated or reversed while the rods are still rotating. In this way the feed may be adjusted to take advantage of the slightest change in the character of the rock. In soft rock a greater downward pressure is possible, while in hard rock the feed is diminished, thereby increasing the number of revolutions per inch of advance. In this manner a constant pressure may be kept on the diamond bit.

The methods used in setting diamonds were practically the same in the operations of the Board and of the contractors. Eight diamonds were placed in a bit, four on the outside and four on the inside cutting edge of the annular ring. Blank bits of special soft Swedish iron, made to gage measure, were furnished by the manufacturers. A clearance of $\frac{1}{64}$ to $\frac{1}{32}$ in. on each stone, depending on the nature of the rock to be drilled, was allowed in

setting the diamonds. In soft rock a greater clearance was necessary in order to prevent the drill cuttings from plugging the bit.

For drilling in rock the machines used by the contractor proved better adapted where progress was the essential point. These machines, equipped with the hydraulic feed, would make 40 ft. a day in good bluestone, while with the screw feed the machines of the Board were limited to 30 ft. An important consideration acting, under the circumstances, in favor of the Board's machines was the relative degree of skill required to operate the two types. The contractor did not deem it expedient to place a man with less than three years' experience in charge of a drill. On the other hand men were used successfully on the Board's machines with but six months' previous training.

Inspection. One man was able to take care of four drill rigs, one test-pit and take ground water observations. He took samples on holes in progress, water observations on completed holes, assisted in locating holes and made monthly estimates on test pits. A single horse was used to travel from one boring to another, when they were at some distance, and also to carry core boxes, sample bottles, marking boards, etc.

Dry and wash samples were placed in small bottles, corked and carefully labeled. These were placed in drawers which were systematically arranged and so subdivided that the samples from any hole could be readily found.

Upon being removed from the core barrel of the boring machine all cores were stored in core-boxes. Each box contained room for four rows of core in the bottom of the box together with three shelves of three rows each. A box would hold about 37 ft. of core, which generally represents about 40 ft. of actual drilling.

The core was labeled, boxed and stored in a small portable building shelved on all sides, where the core boxes were properly painted with number and depth of hole. Here they were readily available for future inspection. In addition to the core boxes, cabinets containing drawers were provided for filing the samples.

Instructions to inspectors were issued (see my "Handbook of Earth Excavation" for wash boring instructions), as follows:

1. Core should be placed in the bottom of core box, as shown in *sketch*, as soon as it is obtained. At "A" place the top piece of core, labeled with hole number and depth. Then place the remainder consecutively as shown: The core at "C" follows that at "B," while that at "E" follows "D." The next layer is filled with core in the same manner. The core placed corresponding to "A" will follow core at "F." After the box is filled it *should be nailed up* at once for storing. In every case, all pieces

of core, obtained from boulders and not properly relating to the hole in question, should be gathered up and placed in a box made for that purpose.

2. Record all seams encountered in rock. If the machine "races" while drilling with screw feed, it is probably in a seam and the depth should be recorded with width of seam. This may be obtained by measuring to the depth at which the drill stops "racing." With the hydraulic feed, an experienced drill runner will put more pressure on the rods so that the machine will not "race," and he will be able to tell you whether it was a seam or soft rock. These data should be checked with the core when it is taken out. Should a seam be encountered, with a loss of water for some time, it would show an open seam of considerable extent and perhaps finally emptying into some waterway. Should the water be lost for a short time only, it would signify a slight cavity in the rock, or a small seam which was made watertight by the rock cuttings in the wash. After the water has been entirely lost, another open seam may be encountered with no surface indications of a loss of water; hence the best expedient is to fill the upper seam by forcing oats through the wash pipe with the water. This will plug the seam and the water will be regained. The core is obtained in pieces, varying from a few inches to several feet in length. Note by inspection whether these pieces are broken off mechanically or whether seams exist.

3. Record the length of core obtained with the amount of the corresponding run and any conditions which may affect this amount. A strong pressure of water has enough force to loosen a soft rock so that it will come up with the wash and leave no core. With the hydraulic feed the runner will be able to make much more progress with a smaller percentage of core. He will use a full pressure of water down the wash pipe and a heavy pressure on the hydraulic feed, grinding to pieces the core of a fairly good rock. Sometimes core will be left in the hole when withdrawing the core barrel. This may be discovered by dropping a weighted tape down the hole and noting the depth. Core, so left, may be recovered by replacing the bit and drilling a little farther.

Conclusions. Among the conclusions reached were the following:

1. The percentage of core obtained, everything else being equal, varied directly with the hardness of the rock.
2. A larger percentage of core was possible with a bit of large diameter.
3. The conglomerates and harder sandstones yield nearly 95%, while the softer, loose and tilted shales yield less than 25% of core at best.

4. A good hard rock suitable for foundation or construction may be granular or nodular in texture and consequently give very little core and that very seamy. This core would be recorded as seamy and would give a false impression of actual characteristics.

5. The amount of core should be but a small factor in a general determination of the quality of the rock. The improper setting of a bit, excessive vibration of the rods, too strong a force of water, or the grinding away of the core, will reduce the amount obtained.

6. Vertical seams will reduce the amount of core. One case is worthy of mention: Ten feet had been drilled and the working of the machine showed no unusual conditions. On pulling up the core barrel, it was found that only 1 ft. of core had been obtained. A weighted tape was dropped into the hole to see whether any core was left, but the hole was found clear and empty. By careful inspection of the core that was obtained, the presence of a vertical seam was discovered. The machine showed no indications of soft rock or horizontal seams in the running, the wash came up throughout the run with good bluestone cuttings. It was concluded, therefore, that the bit had been in a vertical seam and was cutting good rock with its outside diamonds and consequently no core was made and a report to that effect was sent to the office.

7. It is possible from inspection to see whether detached pieces of core are broken mechanically or whether seams exist.

8. Boulders greater than 12 ft. in vertical dimensions were not encountered in the glacial till of this section.

Pressure Tests of Bore Holes. Before beginning the excavations for the foundation of the Olive Bridge Dam, a careful study was made of the rock to a depth of 100 ft. below the creek bed. The purpose of the study was to investigate the rock for possible cavities or openings, and to discover and definitely locate any seams that might exist. To this end 15 diamond drill borings were made, with a total length of 1,300 ft.

Care was taken accurately to locate the position and width of all seams or soft spots encountered during the progress of a bore. The drills were equipped with a screw feed, which insured a uniform rate of progress for a constant number of revolutions per minute. Thus, in a sound rock the drill ran regularly, but as soon as the bit broke through into a softer layer or into a seam, the load was released from the engine and the latter raced. This racing continued until the screw feed had carried the bit down to harder rock, or until it struck the lower side of the seam encountered. As soon as such a racing occurred the engine was *stopped*, the depth of the bottom of the bore noted and a mark *placed on the drill rods*. The set screws holding the rods were

then carefully loosened and any drop of the rods noted. The rods were then slowly turned by hand to work them through any soft filling or mud or clay that might be in the seam. If no settling was noticed, the seam was said to be close. The drill was then started again, and if it continued to race the number of hundredths of a foot were noted until the bit again encountered harder rock.

These indicated seams were later checked with the core to confirm the interpretation of the drill running, and in very few cases were they found to be in error.

The apparatus used to apply pressure to the borings as shown in Fig. 82-A is similar in general construction to that used by Mr. Wm. E. Swift, Division Engineer, Northern Aqueduct Department, and consists essentially of the following parts: A Douglass hand pump, 50 ft. of 1-in. rubber discharge hose, a pressure gage, sufficient lengths of 1-in. and $\frac{3}{8}$ -in. pipe to reach the desired point in the bore, two sets of fine gutta percha washers, and a perforated spacer of $\frac{3}{4}$ -in. pipe to fit between the two sets of washers.

The $\frac{3}{8}$ -in. pipe is loosely telescoped into the 1-in. pipe, both of which extend into the bore.

To the bottom of the $\frac{3}{8}$ -in. pipe is fitted a plug and a half union. Above this half union is placed a set of 8 gutta percha washers, each $\frac{1}{2}$ in. thick, which fit snugly to the $\frac{3}{8}$ -in. pipe and have an outside diameter of $\frac{1}{8}$ in. less than the diameter of the bore.

Between this and the upper set of washers is a spacer of $\frac{3}{4}$ -in. perforated pipe. The upper face of the second set of washers bears directly against the bottom of the outer 1-in. pipe.

The $\frac{3}{8}$ -in. pipe between the two sets of washers is perforated.

To expand the rubbers for a test in a boring, the inner $\frac{3}{8}$ -in. pipe is pulled up a short distance through the 1-in. pipe by means of a simple screw thread device attached to the top of the $\frac{3}{8}$ -in. pipe. As the outer pipe is held stationary, the pull is transmitted from the bottom half union of the $\frac{3}{8}$ -in. pipe to the lower rubbers, and through them to the upper rubbers by the sliding spacer of $\frac{3}{4}$ -in. pipe. As the outside pipe is held stationary by a clamp at the top, this pull gives a squeezing action to the rubbers, thereby expanding them tightly against the wall of the bore.

To make a complete test, the rubbers were expanded in place and water pumped down through the inner pipe, escaping through the perforations in this and the $\frac{3}{4}$ -in. spacer pipe to the rock wall included between the two sets of rubbers.

A standard of 80 lb. indicated gage pressure was assumed because leaks occurred in the connections at higher pressures.

When this pressure was reached, the time was noted and the loss in pounds, if any, indicated by the gage at the end of 60 sec. recorded.

If a leak was encountered, the pressure fell off very rapidly

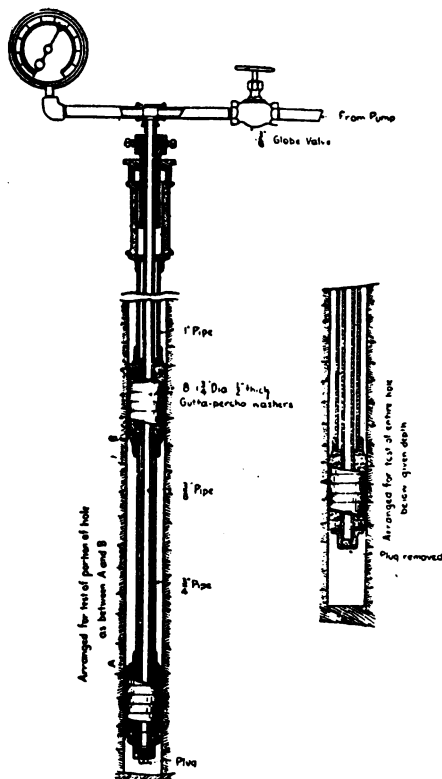

Fig. 82-A. Apparatus for Testing Borings by Hydraulic Pressure.

between each stroke of the pump, and the gage was said to "race."

Nine bores were subjected to water pressure tests and the results recorded. These tests were conducted foot by foot *progressively* from the top to the bottom of the bore, except where *sound rock* was encountered for a considerable distance, when a *4-ft. spacer* was used, testing four consecutive feet at a time.

If, at any test, decided loss of pressure occurred, that is, 30 lb. or more in one minute, the weak spot was located to the tenth of a foot in the following manner:

The core was first examined. This would usually show the approximate location of the seam. The tester was then raised so that the bottom rubbers would cover, or come above the leak, and a test made. If this indicated tight rock, successive tests were taken at intervals of 0.1 ft. until a decided loss in pressure was again noted. The bottom of the leak was also located by coming up with successive tests from below.

This method was effective except where two or more seams might occur less than a foot apart. In such event the record shows a loss for the whole foot, or from the top of the first leak to the bottom of the last one.

A curve was worked out from the results of experiments to establish a relation between the indicated loss in pounds per minute and the parts of a gallon loss per minute. These results were obtained as follows:

A piece of pipe about 2 ft. long, with a valve tapped into the middle of it, was substituted for the rock wall of the bore and the rubbers expanded in the pipe to a tight contact similar to that obtained in testing the rock. About 35 pressure tests were then made ranging from the valve closed, with an indicated loss of 2 lb., to the valve wide open, with a full racing gage.

At each test the amount of escaped water was measured and the number of pounds pressure lost was recorded. By plotting these results the curve above mentioned was obtained.

From an inspection of the curve, it was seen that a very slight leak would cause a heavy loss in pounds pressure. The maximum loss obtained in the tests equaled above five gallons per minute.

CHAPTER IX

EXPLOSIVES

The Action of Gases from an Explosion. In every case an explosion is a chemical action that takes place between the elements of the explosive, liberating suddenly a great volume of gas at a high temperature. Ordinary air moving at a velocity of 100 miles an hour strikes objects with great disruptive force, yet a hurricane is mild indeed compared with the feeblest of explosives.

Black powder, which is the weakest of the common explosives, is exploded at a temperature of 518° F. If its grains are small, as in rifle powder, each grain quickly burns up, yielding the full volume of gas in a short time. If its grains are larger the rapidity with which each grain is converted into gas is slower.

Dynamite and granulated nitro-glycerin powders (e. g. Judson Powder) are exploded not by mere heating, as with black powder, but also by a hard shock delivered usually by a cap, or "detonator," or "exploder." The more severe the blow delivered by the explosion of the cap, the more quickly does the chemical action take place. In any case this chemical action is far more rapid than it is in black powder. The greater the detonating shock the more rapid is the liberation of the gases. Hence it is poor economy to use feeble caps where it is desired to tear rock into small pieces.

If a quantity of dynamite is exploded under water it has been found by actual experiment that the gases fly in all directions with equal velocity and in equal quantity.* Hence it is a mis-

* *Eng. News*, March 12, 1892, "D. E. O." in a letter states that in 1878, near Sawyer City, Pa., a wagon containing 60 qts. of nitroglycerin overturned, and the nitroglycerin exploded. The writer gives a sketch to show the wedge path of the exploded gases. The writer says: "Take two 2 or 3-oz. bottles and fill with nitroglycerin, fit one with an exploder and let the exploder rest on the bottom of the bottle; place this on a sheet of boiler iron and explode. It will be found to have barely brightened the plate. Now fit No. 2 with an exploder fastened in the neck of the bottle and explode, and it will be found to have blown a hole completely through the plate." The writer contends that this experiment proves that dynamite does not exert an equal pressure in all directions when exploded. The editor of *Engineering News* cites the extensive ring-gage tests conducted by Gen. Henry L. Abbot "with nitroglycerin under water." A 5-ft. ring carried six pressure gages, to record pressure of dynamite fired at the center of the ring. The charge was placed in a tin can, placed vertically, and was fired at the top by a detonator. The ring was suspended in a vertical plane

take to suppose that high power explosives act only downward. They exert a pressure equal in all directions at the instant of explosion. Let it be kept clearly in mind that an explosion is merely the sudden creation of a great volume of gas seeking to escape with enormous velocity, and much of the mystery about the effects of an explosion vanishes. Consider the gas as so many minute and invisible rubber balls, each possessed of weight and flying with frightful velocity, and it becomes comparatively easy to explain most of the phenomena attending an explosion.

The gas as it leaves the explosive flies in all directions, but the instant it encounters an object it either rebounds from that object, or tears its way through the object or hurls the object to one side. If the object is very heavy and substantial, the particles of gas rebound from it, like rubber balls rebounding from the side of a house. Hence it often happens that the gases from dynamite, when exploded in an open place, travel along a certain path like a hurricane. They do so because they have rebounded from some immovable objects, and have been, as it were, reflected like rays of light from a mirror.

When dynamite is exploded in a hole drilled in solid rock, the gases are created so suddenly and move with such enormous velocity that when they strike the sides of the drill hole, the rock is struck as if with a mighty sledge; and, if the dynamite is in sufficient quantity, the blow tears off a portion of the rock. This occurs even when the hole above the dynamite is not plugged up with earth or stone chips; but if the hole is left open obviously much of the gas escapes and renders the blow less effective in consequence. Black powder, on the other hand, explodes more slowly so that if the hole is left open a greater proportion of the gas escapes before the last grain of powder has burned up. Hence it is absolutely essential to use great precaution in plugging or "stemming" the hole when black powder is to be fired.

In the early days of dynamite it was commonly stated that no "tamping" above the dynamite was required, and to this day there are text books in use containing this misleading statement. Tamping may not be "required," in the sense that it is absolutely essential; but it is certainly required where the full value of the dynamite is to be utilized in breaking rock, instead of disturbing the air, for there is no profit in shaking up the atmosphere.

Due to the fact that powder gases are elastic, and rebound from any solid surface, it follows that the shape of the drill hole has a decided effect upon the lines along which rock breaks. When holes are drilled by hand they tend to become three-cornered;

from buoys. At a depth of 35 ft., the two upper gages registered 20,366 and 17,576 lbs. per sq. in., and the two lower 15,479 and 14,671 lbs. In a later experiment, 16,000 and 21,000 lbs. were recorded in the upper gages, and 15,000 and 16,000 lbs. in the lower.

and as a result, if black powder is used, the particles of gas bounding back and forth, as fast as they are liberated, batter the three faces of the triangle and tend to split the rock in three directions, the cracks in the rock starting at the corners, or angles of the triangle.

Black Powder. The highest grade of black powder consists of 75% saltpeter (KNO_3), 15% charcoal and 10% sulphur. The charcoal for rifle powder (sporting powder) is commonly made from dogwood, but willow and alder charcoal are commonly used for blasting powder. In some inferior powders lampblack is substituted for part of the charcoal.

In the commonly used blasting powders, the saltpeter (or potassium nitrate) is often replaced by sodium nitrate which deteriorates in time by absorbing moisture from the air. Therefore when blasting powder is used, great care must be taken to keep it in a dry atmosphere, and it should be used soon after it is received from the factory. The composition of black blasting powder sold in this country is generally as follows: 16% charcoal, 11% sulphur, 73% sodium nitrate.

Powder is sold by the "keg" of 25 lb. ordinarily at about \$1.25 per keg for soda powder and \$2.10 for nitre powder. The powder is divided into grades according to the size of the grains. The common grades are CC, C, F, FF, FFF, and FFFF, of which CC represents the largest grains, about $\frac{1}{2}$ in. in diameter, and FFFF the smallest grains, about $\frac{1}{16}$ in. in diameter. The specific gravity of individual grains of powder ranges from 1.5 to 1.85; the average weight of loose powder, slightly shaken, being 62.5 lb. per cu. ft. or .036 lb. per cu. in.; 1 lb. occupies 28 cu. in.

The rate of burning of FF black blasting powder is about 1,538 ft. per second.

TABLE XLIV. RELATION BETWEEN SIZES OF BLACK BLASTING POWDER AND SEPARATING SIEVES

Size of Grains.	Diameter of round holes in screens through which grains pass.	Diameter of round holes in screens on which grains collect.
CC	$\frac{1}{2}$ inch	$\frac{3}{8}$ inch
C	$\frac{3}{8}$ "	$\frac{1}{8}$ "
F	$\frac{1}{8}$ "	$\frac{1}{16}$ "
FF	$\frac{1}{16}$ "	$\frac{1}{32}$ "
FFF	$\frac{1}{32}$ "	$\frac{1}{64}$ "
FFFF	$\frac{1}{64}$ "	$\frac{1}{128}$ "

TABLE XLV. NUMBER OF POUNDS OF POWDER PER FOOT OF DRILL HOLE OF DIFFERENT DIAMETER

Diameter of hole, in.	Amount of powder lb. oz.	Diameter of hole in.	Amount of powder lb. oz.
$\frac{3}{8}$	0 3	3	.3 0 $\frac{1}{2}$
$\frac{1}{2}$	0 4	3 $\frac{1}{4}$	3 9
1	0 5 $\frac{1}{4}$	3 $\frac{1}{2}$	4 2
1 $\frac{1}{8}$	0 6 $\frac{3}{4}$	3 $\frac{3}{4}$	4 11 $\frac{1}{2}$
1 $\frac{1}{4}$	0 8 $\frac{1}{2}$	4	5 5 $\frac{1}{4}$

Diameter of hole, in.	Amount of powder lb. oz.		Diameter of hole, in.	Amount of powder lb. oz.	
	lb.	oz.		lb.	oz.
1 ½	0	10	4 ½	6	13
1 ½	0	12	5	8	6 ½
1 ¾	1	0 ½	5 ½	10	3
2	1	5 ½	6	12	2
2 ¼	1	11 ¾	8	21	8 ¾
2 ½	2	2	10	33	10
2 ¾	2	8 ¾			

Properties of Good Black Powder. A good blasting powder has a uniform dark gray or slaty color. A dead black, or a bluish color, indicates either too much charcoal or the presence of moisture. When poured over a sheet of white paper it should leave no dust, for dust indicates either the presence of moisture or of fine mealy powder. The grains should be quite uniform in size, and should have no sharp or angular corners.

Where the different sizes are mixed as in "run of mill" powder, the force exerted by the same amount of powder in different charges will vary. It is evident that the larger the grain the slower the combustion proceeds. For this reason, a fine-grained powder is often called a "quick" powder and a large grained powder a "slow" powder. Moreover, where large and small grains are mixed, the fine grains burning quickly may produce enough pressure to throw the large grains out of the hole before the latter are fully consumed. On pressing between the fingers there should not be a crackling sound due to sharp grains, nor should the grains crush easily. When crushed the grains should show uniformity of color. Light colored spots in the powder show that the saltpeter has leached out, due to the presence of moisture, which reduces the strength and reliability of the powder. If there are no white spots it may be assumed that the powder has not suffered from dampness; so that if it is slightly damp but still uniform in color it can be dried out in the sun and will be as good as ever. A pinch of good powder ignited on a sheet of white paper burns away rapidly, leaving no residue. If black spots remain on the paper they show an excess of charcoal or poor mixing of the ingredients. Yellow spots indicate an excess of sulphur. If holes are burned in the paper they indicate an excess of moisture, or other imperfections.

Dynamite and Nitroglycerin. Any explosive containing nitroglycerin is commonly called dynamite. Nitroglycerin is made by mixing 1 to 1.17 parts of pure glycerin with 3 parts of nitric acid and 5 parts sulphuric acid. The glycerin is added very slowly, with constant stirring, compressed air usually being used to stir the liquids. The process of manufacture is exceedingly dangerous.

Nitroglycerin is an oily fluid, as clear as water when perfectly pure, but it usually has a yellowish tint. Its specific gravity

is 1.6, so that it weighs nearly 0.058 lb. per cu. in., or 102 lb. per cu. ft. It freezes at from 38 to 55 deg. F. (water freezes at 32 deg. F.), and instead of swelling as water does on freezing, it shrinks about 8% in volume. Nitroglycerin evaporates rapidly at 158 deg. F.; and even at 104 deg. dynamite will lose 10% of its nitroglycerin in the course of a few days. Hence the necessity of keeping dynamite in a cool place in summer, and in a warm (but not above 90 deg. F.) place in winter. In small quantities nitroglycerin will ignite and burn up without exploding at 356 deg. F., but at 423 deg. F. it explodes violently. In large quantities, heated slowly, it will explode at 356 deg. F. If the nitroglycerin is impure it will explode at lower temperatures. Indeed it is possible for impurities to start a chemical decomposition which will result in a rise in temperature ending in spontaneous explosion.

If, after the mixture of the ingredients, every trace of acid is not washed out of the nitroglycerin, there is an everpresent danger of chemical action in the nitroglycerin that may lead to an explosion upon the slightest provocation. Chemical decomposition usually liberates nitrous fumes which color the nitroglycerin green. If there is any greenish color in dynamite it may indicate that chemical action has begun and that the material is dangerous to handle. In nitrate of ammonia powders this green may be natural. Free acid in nitroglycerin can be detected by blue litmus paper which the acid turns red.

In order to destroy deteriorated nitroglycerin pour it into a strong solution of sal soda (sodium carbonate) and stir gently with a wooden paddle, pour off the soda solution, and pour the nitroglycerin onto sawdust which should be dumped into a pile of hay and set ablaze. Dynamite in a wooden box containing no metallic nails can be burned up without exploding, but any nail or metal may conduct the heat so as to explode the dynamite. Another method of destroying dynamite is to mould a ball of moist black powder, place the end of a slow fuse in this ball, pile the dynamite over it, soak with oil, and set fire to the fuse.

Pure nitroglycerin has been carried by a rocket to a height of 1,000 ft. and dropped without exploding upon striking the earth. Yet the purest of nitroglycerin is apt to explode by shock if it is confined in a vessel. When impure it will explode, even when unconfined, upon receiving a slight shock. A small quantity of nitroglycerin will burn quietly without exploding; but where a large quantity is burning the heat generated will bring *the entire mass* to a temperature at which an explosion will occur.

On account of its sensitiveness to shock when slightly impure,

nitroglycerin is not used for blasting to any great extent nowadays. It is used in its liquid state chiefly for "shooting" oil wells, so as to open up crevices in the rock through which the oil may flow to the well. The nitroglycerin is poured into tin "shells," 3 to 5 in. diam. by 5 to 20 ft. long, and lowered with a wire to the bottom of the well hole. An iron weight with a hole through its center is strung on the wire and allowed to drop, thus exploding a cap on the cover of the "shell."

Composition of Dynamite. Dynamite consists of any absorbent or porous material saturated or partly saturated with nitroglycerin. The absorbent is commonly called "dope." A good dope should have minute voids in which the nitroglycerin is held by capillary action. Since the dope acts like a cushion it renders the nitroglycerin much less sensitive to shocks. Alfred Nobel, who invented dynamite in 1866, used porous, earthy powder, reddish in color, called kieselguhr, as the absorbent to hold the liquid nitroglycerin in its pores, somewhat as a sponge holds water. Kieselguhr is a diatomaceous earth which consists of the silicious remains of microscopic plants called diatoms. These diatoms contain microscopic pores or cells which hold the nitroglycerin by capillary action. As this earth could neither burn nor explode, it was called an "inactive dope." There are several varieties of dynamite with inactive dopes such as wood pulp, etc.

Nitroglycerin may be absorbed in gunpowder, and as the gunpowder will explode as well as the nitroglycerin, it is called an "active dope."

I find in the Census Report for 1900 that in the annual production of 42,900 tons of dynamite there were used: 15,800 tons of nitroglycerin, 20,000 tons of sodium nitrate, 5,000 tons of wood pulp and 240 tons of ammonium nitrate. It will be seen from this report that dynamites with an inert base or "dope" of kieselguhr, or magnesium carbonate, are but little made in America; and that dynamites with an explosive base of the nitrate class have taken their place. It will also be seen that the nitroglycerin used averages about 38% of the weight of the dynamite as now manufactured.

The word "powder" is commonly used instead of the word dynamite, and, in consequence, often leads to confusion with black powder.

Grades of Dynamite. The strength of dynamite is rated by "per cent," and dynamite is known as "40 per cent dynamite," or "60 per cent dynamite," etc. In the "straight" (inactive dope) nitroglycerin dynamites the percentage of the weight of the nitroglycerin determines the grade; *i. e.*, if 40% of the weight is nitroglycerin it is known as "40% powder." Dynamites with an active base are rated by a comparison of their strength with

TABLE XLVI. EXPLOSIVES EQUIVALENT IN STRENGTH TO ATLAS

Atlas Brand	Per cent. nitro-Gelatin	Repano glycerin	Powder Hercules	Giant Powder	Giant Powder	Giant Gelatin	Hecla Powder	Etna Powder	Hercules Gelatin	Racka-rock
A	75	A	No. 1 XX	Old No. 1	No. 1 A	No. 1 A	No. 1 XX	No. 1 XX	A
B+	60	B+	No. 2 SS	No. 1 A	No. 1	No. 1 XS	No. 1 XS	No. 2 XX	No. 2 SS	A X
C+	45	C+	No. 2 S	New No. 1	No. 2	No. 1 X	No. 1 X	No. 2 X	No. 1 S	C1
D+	40	C	No. 2 C	No. 2 Extra	No. 1	No. 2 A	No. 2	C2
E+	33	...	No. 3 C	No. 2 C	No. 3 C	No. 2 X	No. 3 A
E	30	...	No. 3 B	No. 3	No. 3 X	No. 3 B
	27	...	No. 4 B	XXX	No. 2 X	No. 3 B
	20	...	No. 4 B	XXXX	No. 3	No. 4

(a) Consisting of wood pulp, flour and sulphur for grades below 40%; wood pulp only, for other grades.

Ammonia Dynamite. These dynamites take up moisture very readily, because ammonium nitrate is deliquescent, and they should be carefully stored in dry places or they will spoil. The ammonium nitrate used in these powders goes completely into gas and thus is somewhat more effective than the sodium nitrate.

TABLE XLIX. AMMONIA DYNAMITE

Ingredients	Per cent.				
	30	35	40	50	60
Nitroglycerin	15	20	22	27	35
Ammonium nitrate	15	15	20	25	30
Sodium nitrate	51	48	42	36	24
Combustible material (a)	18	16	15	11	10
Calcium carbonate or zinc oxide	1	1	1	1	1
	100	100	100	100	100

(a) Consisting of wood pulp.

Gelatin Dynamites. Under certain conditions, nitroglycerin acts as a solvent. It dissolves nitrocellulose, and the mixture formed sets to a jelly-like mass. In this way "explosive gelatin" is formed, and is, in some respects, an ideal explosive. It is impervious to water. However, it is too powerful for ordinary use and is diluted with other substances to form gelatin dynamite.

TABLE L. GELATIN DYNAMITE

Ingredients	Per Cent.						
	30	35	40	50	55	60	70
Nitroglycerin	23.0	28.0	33.0	42.0	46.0	50.0	60.0
Nitrocellulose	.7	.9	1	1.5	1.7	1.9	2.4
Sodium nitrate	62.3	58.1	52	45.5	42.3	38.1	29.6
Combustible material (a)	13	12	13	10	9	9	7
Calcium carbonate	1	1	1	1	1	1	1

(a) Wood pulp in 60 and 70% strength. Sulphur, flour, wood pulp, sometimes resin used in other grades. Some manufacturers replace a small percentage of nitroglycerin in these grades with an equal amount of ammonium nitrate.

Brands of Dynamite. The following are some of the brands of dynamites that have been used:

ATLAS POWDER (75%)

Nitroglycerin	75 parts.
Wood fiber	21 "
Sodium nitrate	2 "
Magnesium carbonate	2 "

RENDROCK (40%)

Nitroglycerin	40 parts.
Potassium nitrate	40 "
Wood pulp	13 "
Pitch	1 "

GIANT POWDER No. 2 (40%)

Nitroglycerin	40 parts.
Sodium nitrate	40 "
Sulphur	6 "
Resin	6 "
Kieselguhr	8 "

STONITE (68%)

Nitroglycerin	68 parts.
Kieselguhr	20 "
Woodmeal	4 "
Potassium nitrate	8 "

DUALIN (40%)

Nitroglycerin	40 parts.
Sawdust	30 "
Potassium nitrate	30 "

CARBONITE (25%)

Nitroglycerin	25 parts.
Woodmeal	40½ "
Sodium nitrate	34 "
Sodium carbonate	½ "

HERCULES (40%)

Nitroglycerin	40 parts.
Potassium nitrate	31 "
Potassium chlorate	3 1-3 "
Magnesium carbonate	10 "
Sugar	15⅔ "

VIGORITE (30%)

Nitroglycerin	30 parts.
Potassium chlorate	49 "
Potassium nitrate	7 "
Wood pulp	9 "
Magnesium carbonate	5 "

HORSLEY POWDER (72%)

Nitroglycerin	72 parts.
Potassium chlorate	6 "
Nutgalls	1 "
Charcoal	21 "

GELIGNITE (62½%)

65% of blasting gelatin, containing	{	Nitroglycerin, 96%
		Collodion cotton, 4%
35% of absorbent, containing	{	Sodium nitrate, 75%
		Sodium Carbonate, 1%
		Wood pulp, 24%

FORCITE (49%)

50% of blasting gelatin, containing	}	Nitroglycerin, 98%
		Collodion cotton, 2%
50% of absorbent containing	}	Sodium nitrate 76%
		Sulphur, 3%
		Wood tar, 20%
		Wood pulp 1%

JUDSON GIANT POWDER NO. 2 (40%)

Nitroglycerin	40 parts.
Sodium nitrate	40 "
Resin	6 "
Sulphur	6 "
Kieselguhr	8 "

VULCANITE (30%)

Nitroglycerin	30 parts.
Sodium nitrate	52½ "
Sulphur	7 "
Charcoal	10½ "

LITHOFRACTEUR

Nitroglycerin	55%
Kieselguhr	21%
Charcoal	6%
Barium nitrate and carbonate of soda	15%
Sulphur and Manganese oxide	3%

Weight of Dynamite. Dynamite is commonly packed in paper cartridges, each "stick" being from 6 to 16 in. long, and $\frac{7}{8}$, 1, $1\frac{1}{4}$ to 2 in. in diameter. The most common size is $1\frac{1}{4} \times 8$ in. long, weighing 0.5 to 0.6 lb., or 0.06 lb. per cu. in., or 1 lb. occupies 17 cu. in. Dynamite is shipped in cases or boxes holding 25 or more commonly, 50 lb. of dynamite. The shipping weight of a 25 lb. case is from 29 to 34 lb., and of a 50 lb. case it is from 58 to 65 lb. A 50 lb. box has $\frac{3}{4}$ cu. ft. capacity.

The old Nobel's 75% dynamite, with the kieselguhr "dope," weighs .054 lb. per cu. in. The following table gives the weight of 75% kieselguhr dynamite:

Weight of Nobel's No. 1 dynamite (75% nitroglycerin and 25% kieselguhr):

Diam. of stick.	Weight in lb. per inch of stick.	Diam. of stick.	Weight in lb. per inch of stick.
1 in.	.042	1½	.128
1¼ in.	.065	2	.168
1½ in.	.094	2½	.212

The manufacturers of "Atlas C" inform me that a $1\frac{1}{4} \times 8$ -in. stick weighs about 0.6 lb., and that it is one of the "tricks of

the trade" to make the absorbent of such material that all grades of dynamite weigh about the same per stick ($1\frac{1}{4}$ x 8 in.).

Sizes and Weights of Dynamite Cartridges (8 in. long).	
Diameter of cartridge, in.	Approximate weight, oz.
$\frac{3}{8}$	2
$\frac{1}{2}$	4
$\frac{3}{4}$	5
$1\frac{1}{4}$	6
$1\frac{1}{2}$	9
$1\frac{3}{4}$	12
2	16

Blasting Gelatin. When cotton is treated with nitric acid, gun cotton or nitrocellulose is produced. Starch treated with nitric acid produces nitrostarch. These when dissolved in nitroglycerin produce blasting gelatin. It has a specific gravity of 1.6 and freezes at 35 deg. to 40 deg. F. It is far more dangerous than dynamite when frozen, being more sensitive to shocks in the frozen condition than when soft. It is peculiarly adapted for use in tropical climates or in summer work, since it does not absorb water and does not leak nitroglycerin under any conditions, even after long exposure to 90 deg., nor does it leak after repeated freezing and thawing. In cold weather its extreme sensitiveness when frozen makes it exceedingly dangerous.

Gelatin dynamite is an explosive containing blasting gelatin and an explosive "dope." Forcite, Repano gelatin, Hercules gelatin, and Giant gelatin are the best known gelatin dynamites. They are apt to leak and should be tested precisely as ordinary dynamite is tested, for leakage, by repeated freezing and thawing and by prolonged exposure at 90 deg. F. as described on page 433.

Judson Powder and Contractors' Powder. Judson Powder is a granulated nitroglycerin powder. The composition of the basic grains of these powders is somewhat similar to that of black blasting powder but instead of the nitrate and the combustible materials being thoroughly incorporated, nitrate, sulphur, coal and resin are heated until the sulphur and resin melt. The sticky mass is then granulated by cooling while being rubbed through a fine-mesh screen. The grains are coated or the voids are partially filled with a small percentage of nitroglycerin. The composition of Judson Powder R. R. R. (railroad powder) is as follows:

	Per cent.
Nitroglycerin	5
Sodium nitrate	64
Sulphur and resin	16
Cannel coal	15

This powder is packed in $6\frac{1}{4}$ and $12\frac{1}{2}$ -lb. bags. It must be detonated with a nitroglycerin dynamite cap.

Other grades of Judson Powder are the 10, 15, and 20% which are put up in cartridges of the following sizes: 1 x 8 in., 1¼ x 8 in., 1½ x 8 in., 1¾ x 8 in., 2 x 8 in., and 2 x 18 in. They are exploded with a detonator (Du Pont No. 6).

Contractors' Powder, manufactured by the Ætna Powder Co., is a granulated nitroglycerin powder containing 8% nitroglycerin. It is put up in 12.5-lb. bags, 4 bags to the case. This powder cannot be exploded by fire alone. A piece of dynamite must be used as a primer and should be well buried in the powder. It comes in 4 grades: A (the strongest), AA, B, and D (the weakest).

The rate of detonation of granulated powder is about 3,339 ft. per sec. or twice that of black powder.

Trojan Powder. Trojan powder will not explode from any ordinary impact or jar and is practically non-freezing and fumeless. This powder is put up in cartridges of any size, packed in cases of 50 lb. each and in bags of 12.5 lb. It is graded the same as nitroglycerin dynamite, 20, 30, 40, 50, 60, and 75%.

Rackarock. Rackarock is a blasting powder of about the force of dynamite which is distinguished from all other high explosives in that it is composed of two non-explosive ingredients (a solid and a liquid) which may be kept separate until they are required for use and then mixed. It consists of 79 parts of chlorate of potash and 21 parts of Mono-nitro benzene, which are mixed just before use. There is no nitroglycerin in this explosive. The mixing process simply consists of pouring a measured quantity of the liquid over the solid ingredient, which is put up in cloth covered cartridges. About one hour after mixing the powder is ready for use. Rackarock is exploded in the same manner as dynamite, by means either of a quintuple-force blasting cap attached to ordinary blasting fuse or by an electric fuse. It should be well tamped.

This powder is put up in three grades: A, Ax, and C. The first is equal to No. 1 dynamite, the second to No. 2 dynamite, and the third is used in special cases where but a moderate resistance is encountered. The cartridges kept in stock ready for shipment are 1 in., 1¼ in., 1½ in., 1¾ in., and 2 in. in diameter. Rackarock is also put up in 20-quart tin shells for shooting oil or other wells.

Rackarock was used in the Hell Gate explosion. This powder is not adapted for under-ground work, but is particularly effective in open-cut excavation work and is used extensively in open copper mines, etc. It will not freeze nor deteriorate and the smoke produced is not nauseous.

Mercury Fulminate. When mercury is dissolved in strong nitric acid, and the solution poured into common alcohol, a

violent reaction takes place and fine, gray crystals are produced. This is known as fulminate of mercury. It is extremely sensitive and is kept soaked in water until desired for use. It is principally used in caps or detonators. Fulminate of mercury is very poisonous. It can be exploded by friction, by a blow, by fire or by heating, and is therefore very dangerous to handle.

Permissible Explosives. The generation of certain gases from explosives is very dangerous, particularly in coal mines. The U. S. Geological Survey has therefore instituted certain tests for the determination of the gases and flame generated by the explosion of dynamites or powders. The explosives which pass these tests are known as "Permissible Explosives." The following is a list of permissible explosives tested prior to January 1, 1914. Detonators, preferably electric, of not less strength than No. 6 should be used with all these explosives; except that No. 7 should be used with Bental Coal Powder No. 2, Cronite No. 5, Guardia A, Guardian Coal Powder B, Hecla No. 2; and No. 8 should be used with Kanite A.

The class numbers in the Table LI are: Class 1, Ammonium Nitrate; Class 2, Hydrated; Class 3, Organic Nitrate other than nitroglycerin; Class 4, Nitroglycerin.

TABLE LI. WEIGHT OF EXPLOSIVES IN LB. PER FT. OF DRILL HOLE

Name.	Specific Gravity.	%	Diameter of hole, in.				
			1/2	3/4	1	1 1/4	
Blasting powder	1.000	.143	.228	.340	.480	.664	.880
Carbonite	1.120	.160	.258	.380	.541	.742	.988
Ardur powder	1.160	.166	.264	.394	.561	.769	1.024
Blasting gelatin	1.550	.222	.352	.526	.749	1.027	1.367
Gelatin dynamite	1.550	.222	.352	.526	.749	1.027	1.367
Dynamite	1.600	.229	.363	.543	.773	1.060	1.060

Name.	Specific Gravity.	Diameter of hole, in.						
		1 1/2	1 3/4	2	2 1/4	2 1/2	2 3/4	
Blasting powder	1.000	1.148	1.459	1.822	2.240	2.720	3.872	5.312
Carbonite	1.120	1.280	1.630	2.036	2.505	3.040	4.328	5.936
Ardur powder	1.160	1.330	1.690	2.160	2.597	3.151	4.488	6.152
Blasting gelatin	1.550	1.775	2.256	2.819	3.467	4.211	5.991	8.218
Gelatin dynamite	1.550	1.775	2.256	2.819	3.467	4.211	5.991	8.218
Dynamite	1.600	1.833	2.329	2.910	3.579	4.347	6.184	8.480

TABLE LII. PERMISSIBLE EXPLOSIVES

Brand.	Class.	Manufacturer.
Ætna coal powder A	Class 4	Ætna Powder Co., Chicago. Ill.
Ætna coal powder AA	Class 1 a	Do.
Ætna coal powder B	Class 4	Do.
Ætna coal powder C	do.	Do.
Bental coal powder No. 1-A	Class 1 a	Independent Powder Co., Joplin, Mo.
Bental coal powder No. 2	do.	Do.
Bental coal powder No. 2-X	do.	Do.
Bituminite No. 1	Class 4	Jefferson Powder Co., Birmingham, Ala.
Bituminite No. 3	do.	Do.

Brand.	Class.	Manufacturer.
Bituminite No. 4	do.	Do.
Bituminite No. 5	Class 1 a	Do.
Black Diamond No. 2-A	Class 4	Illinois Powder Manufacturing Co., St. Louis, Mo.
Black Diamond No. 3-A	do.	Do.
Black Diamond No. 5	Class 1 a	Do.
Black Diamond No. 6-L, F	Class 4	Do.
Cameron mine powder No. 1-A	Class 1 a	Cameron Powder Manufacturing Co., Emporium, Pa.
Cameron mine powder No. 2-A	do.	Do.
Cameron mine powder No. 2-A, L, F	do.	Do.
Cameron mine powder No. 3-A	Class 4	Do.
Carbonite No. 1	do.	E. I. du Pont de Nemours Powder Co., Wilmington, Del.
Carbonite No. 2	do.	Do.
Carbonite No. 3	do.	Do.
Carbonite No. 4	do.	Do.
Carbonite No. 5	do.	Do.
Carbonite No. 6	do.	Do.
Coalite A	Class 1 a	Atlas Powder Co., Wilmington, Del.
Coalite X	do.	Do.
Coalite No. 1	Class 4	Do.
Coalite No. 2-D	do.	Do.
Coalite No. 2-D, L	do.	Do.
Coalite No. 2-M, L, F	do.	Do.
Coalite No. 3-X	Class 1 a	Do.
Coalite No. 3-XA	do.	Do.
Coalite No. 3-XB	do.	Do.
Coalite No. 3-XC	do.	Do.
Coal special No. 1	Class 4	Keystone National Powder Co., Emporium, Pa.
Coal special No. 2	do.	Do.
Coal special No. 2-W	do.	Do.
Coal special No. 3-C	do.	Do.
Collier powder B, N, F	Class 1 a	Do.
Collier powder KN	do.	Do.
Collier powder No. X	do.	Do.
Collier powder X, L, F	do.	Do.
Collier powder No. 2	Class 4	Do.
Collier powder No. 5	Class 1 a	Do.
Collier powder No. 5-L, F	Class 1 a	Do.
Collier powder No. 5 special	do.	Do.
Collier powder No. 6-L, F	Class 4	Do.
Collier No. 9	Class 1 a	Do.
Collier powder No. 11	do.	Do.
Cronite No. 1	do.	G. R. McAbee Powder & Oil Co., Pittsburgh, Pa.
Cronite No. 5	do.	Do.
Detonite special	do.	The King Powder Co., Cincinnati, Ohio.
Eureka No. 2	Class 2	G. R. McAbee Powder & Oil Co., Pittsburgh, Pa.
Fort Pitt mine powder No. 1	Class 4	Fort Pitt Powder Co., Pittsburgh, Pa.
Fuel-ite No. 1	do.	Burton Powder Co., Pittsburgh, Pa.
Fuel-ite No. 2	do.	Do.
Fuel-ite No. 3	Class 1 a	Do.
Giant A low-flame dynamite	Class 2	Giant Powder Co. (Consolidated), Giant, Cal.
Giant B low-flame dynamite	do.	Do.
Giant C low-flame dynamite	do.	Do.
Giant coal-mine powder No. 5	Class 1 a	Do.
Giant coal-mine powder No. 6	Class 2	Do.
Giant coal-mine powder No. 7	do.	Do.
Giant coal-mine powder No. 8	do.	Do.

Brand.	Class.	Manufacturer.
Guardian A	Class 4	Independent Powder Co., Joplin, Mo.
Guardian No. 2	Class 1 a	Do.
Guardian No. 2-X	do.	Do.
Guardian No. 3	do.	Do.
Guardian No. 3-X	do.	Do.
Guardian coal powder B	Class 4	Do.
Hecla No. 2	Class 1 a	E. I. du Pont de Nemours Powder Co., Wilmington, Del.
Kanite A	Class 1 b	W. H. Blumenstein Chemical Works, Pottsville, Pa.
Lomite No. 1	Class 2	G. R. McAbee Powder & Oil Co., Pittsburgh, Pa.
Lowinite No. 2-B	Class 1 a	Lowite Explosives Manufacturing Co., Pittsburgh, Pa.
Meteor AXXO	Class 2	E. I. du Pont de Nemours Powder Co., Wilmington, Del.
Mine-ite A	Class 4	Burton Powder Co., Pittsburgh, Pa.
Mine-ite A-2	do.	Do.
Mine-ite B	do.	Do.
Mine-ite B-2	Class 4	Do.
Mine-ite No. 5-D	Class 1 a	Do.
Monobel No. 1	do.	E. I. du Pont de Nemours Powder Co., Wilmington, Del.
Monobel No. 2	do.	Do.
Monobel No. 3	do.	Do.
Monobel No. 4	do.	Do.
Monobel No. 5	do.	Do.
Monobel No. 6	do.	Do.
Monobel No. 7	do.	Do.
Nitro low-flame No. 1	Class 4	Nitro Powder Co., Kingston, N. Y.
Nitro low-flame No. 2	do.	Do.
Red H No. 1	Class 1 a	Hercules Powder Co., Wilmington, Del.
Red H No. 2	do.	Do.
Red H No. 3	do.	Do.
Red H No. 4	do.	Do.
Red H No. 5	do.	Do.
Red H No. 6	do.	Do.
Red H No. 7	do.	Do.
Trojan coal powder H	Class 3	Pennsylvania Trojan Powder Co., Allentown, Pa.
Trojan coal powder I	do.	Do.
Trojan coal powder J	do.	Do.
Tunnelite B	Class 1 a	G. R. McAbee Powder & Oil Co., Pittsburgh, Pa.
Tunnelite C	do.	Do.
Tunnelite No. 5	Class 4	Do.
Tunnelite No. 6	do.	Do.
Tunnelite No. 6-L, F	do.	Do.
Tunnelite No. 7	do.	Do.
Tunnelite No. 8	do.	Do.
Tunnelite No. 8-L, F	do.	Do.
Vigorite No. 1	do.	Atlas Powder Co., Wilmington, Del.
Vigorite No. 6	do.	Do.
Xpdite No. 1	do.	Hercules Powder Co., Wilmington, Del.
Xpdite No. 2	do.	Do.
Xpdite No. 3	do.	Do.
Xpdite No. 4	do.	Do.
Xpdite No. 5	do.	Do.
Xpdite No. 6	do.	Do.

Thawing Dynamite. The nitroglycerin in dynamite freezes at 38 to 55 deg. F., according to the character of the "dope." When frozen it cannot be exploded by the ordinary caps used in blasting; nevertheless in its frozen state it is exceedingly sensitive to friction or to any breaking or cutting of the frozen cartridge. The Annual Report for 1898 of the Inspectors of Explosives of Great Britain states that in 1898 there were 81 accidents in thawing dynamite, resulting in killing 68 men and injuring 97. Accidents from other causes were 194 in number, resulting in the killing of 52 men and the injury of 216. This shows in a striking manner how dangerous a process the thawing of dynamite is. The following are a few of the methods of thawing that are given in the report as having led to injury or death:

Some cartridges being thawed on a stone in a weigh house; thawing cartridges in front of a kitchen fire; thawing dynamite on a shovel; cartridges placed near a fire to thaw; cartridges placed in an oven to thaw; hot-water thawer, containing dynamite placed on a blacksmith's fire; thawing dynamite with a candle; warming dynamite over a blacksmith's fire; heating dynamite in a tin over a candle; rubbing cartridge in hands to complete thawing; cartridge left in pocket of trousers, which were hung before fire to dry; thawing dynamite in water over a fire; *nine separate accidents from re-heating water which had been used in a dynamite thawer, averaging one killed and one injured for each accident.*

I have italicized this last mentioned cause of accident, because in my judgment it is at the base of the great majority of all accidents from thawing dynamite. It shows that the nitroglycerin leaks out of the dynamite especially when subject to heat in the presence of water. *Dynamite should never be thawed by plunging the sticks into warm water.*

Nitroglycerin will often leak out of a stick even when the stick is dry but is subjected to heat. This I have actually seen. In driving a prospect tunnel in Idaho it was our custom to thaw dynamite in the oven of a cook-stove; but, when the thawing did not progress rapidly enough, we would hold sticks of dynamite in our hands over the top of the stove. While doing this one day I noticed that a drop of nitroglycerin had leaked through the folds of the paper cartridge and was about to fall upon the stove. In my haste to move the stick away the drop fell upon the hot stove, exploding with a report like a pistol shot and cracking the stove so badly that live coals fell into the oven. The dynamite in the oven immediately began to burn *up without exploding.* It is perhaps needless to add that those *of us who were in the cabin went out during the time that*

the dynamite was baking. Free nitroglycerin is exceedingly sensitive to shock and heat combined, and one drop of it falling even a short distance upon any hot object will explode, and by its explosion set off any sticks of dynamite nearby.

Dynamite cartridges should never be broken in two. The cartridges should be slit (longitudinally) with a sharp knife when necessary.

Mr. E. E. R. Tratman has cited an instance where dynamite sticks were placed on a canvas cover over a pot of boiling water; nitroglycerin leaked out, and through the canvas settled on the bottom of the pot, where it exploded, the water above it acting as a tamping.

A man working for me laid some sticks of 75% dynamite upon a flat stone which he had previously heated by placing hot coals upon it. While in the act of picking up a handful of thawed sticks he was blown to pieces. Probably the cause was the leaking out of a drop of nitroglycerin which, falling upon the hot stone, exploded the remaining sticks. He was using this method directly contrary to orders, because he had "thawed dynamite all his life in that way." Familiarity breeds contempt for the danger ever present in thawing dynamite, and the manager of blasting operations must not rely merely upon orders to the men not to do this or that, but must be vigilant to observe whether orders are obeyed or ignored. Instant dismissal of an employee should be the punishment of the slightest infraction of rules governing the use of explosives.

Dynamite can — but should not — be ignited with a match, and will usually burn up without exploding, provided that there are only a few sticks not confined in any way. This fact has had much to do with breeding contempt for the danger attending thawing.

Low-grade dynamites (40% and under) are safer to thaw than high-grade dynamites, because the "dope" is not so thoroughly saturated with nitroglycerin, and for that reason is not so apt to "leak"; but in the presence of hot water any grade of dynamite will have its nitroglycerin displaced slowly by the water. In fact, if the manufacturers are not careful to remove every trace of water from the nitroglycerin there is danger of "leaking." When the paper cartridges feel greasy it may be due to leakage of nitroglycerin. The paraffin on the paper will also produce a greasy feeling. When a whitish crust (or efflorescence) is found on the outside of a dynamite cartridge it indicates that the dynamite has been stored in a damp place, or that the "dope" originally contained an excess of moisture. In either case the crust is nitrate of soda that has dissolved out, and such dynamite is certain to have leaked nitroglycerin. It is

unreliable, dangerous to handle, and should be destroyed at once. Greenish stains inside the cartridge indicate that the nitroglycerin is decomposing and is dangerous.

I have laid particular stress upon the leaking of nitroglycerin from dynamite, because it is so common a source of accident and because the fact that dynamite can be exploded under water has led many to infer that water has no deleterious effect upon it. Dynamite under water, excepting gelatine dynamite, begins to part with its nitroglycerin immediately, the water slowly replacing the nitroglycerin in the "dope," and even in cold water a few hours of soaking will materially decrease the percentage of nitroglycerin. In warm water the replacement is much more rapid.

Dynamite should never be thawed in hot water or by direct exposure to steam.

How to Thaw Dynamite. We have seen how dangerous it is to thaw dynamite by plunging the sticks into hot water or by allowing live steam to strike the sticks, due to the fact that the water forces the nitroglycerin out of the stick; and we have seen how sensitive such free nitroglycerin is to slight shocks, especially when hot. We have seen how exceedingly dangerous it is to place dynamite upon a stove, or in front of an open fire, or upon the top of a steam boiler, or upon a hot stone. How, then, can dynamite be thawed with comparative safety?

Green manure is an effective and safe material to use in thawing dynamite. Manure gives off heat only when it is fresh. On the Croton Dam work the following method was used: A cubical box $2\frac{1}{2}$ ft. on a side is set inside a box 16 in. larger on a side, and the 8-in. space filled with manure rammed hard. These two boxes are placed in a cubical hole in the ground and 15 in. of loosely rammed manure is packed around. The floor of this magazine is filled to a depth of 10 in. with hard rammed manure, leaving a remaining space that easily holds 50 lb. of dynamite. The lid is provided with a pipe chimney $2\frac{1}{2}$ ft. long, having a sliding cover for ventilation. The dynamite is piled in loosely, the lid closed and manure covered over it to a depth of 12 in. The ventilator, as a rule, is left slightly open, and at 32 deg. F. outside the powder will thaw in 3 to 5 hr.; at 0 deg. F. outside it will thaw in 8 hr. This thaw box is cheap, simple and safe. The manure on the bottom of this magazine acts as a cushion to absorb any nitroglycerin that might leak out. It is necessary to change all the manure occasionally.

I am not favorably impressed with any method of thawing *that involves standing the sticks of dynamite on end, for that facilitates the leakage of nitroglycerin.* I have seen a box of

dynamite that had been stored on its end in a magazine, and the nitroglycerin had leaked from the cartridges saturating the wood of the box.

The plan of placing a can of hot water in a small thawing magazine is one of the safest methods that can be adopted. Such a method is illustrated in Fig. 83.

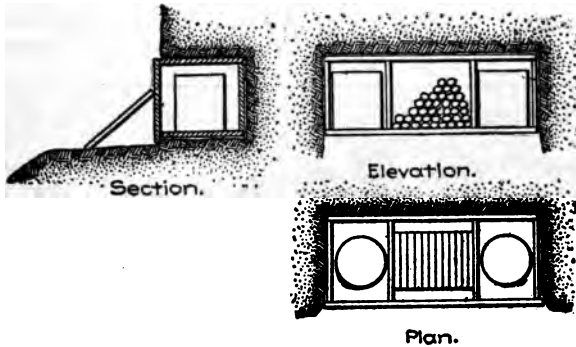

Fig. 83. Small Thawing Magazine.

Where a very large quantity of dynamite must be thawed daily, a small thaw-house should be built with several doors in front, and tiers of drawers that slide out should be placed immediately back of the doors, so that a man cannot enter the thaw-house itself from the front. This prevents men from loitering in the thaw-house, and possibly standing inside to light a pipe. The dynamite is laid in the drawers (6 in. deep x 16 x 22 in.) on a thin bed of sawdust. In the rear of the thaw-house, back of the drawers, room is left for a small hot water radiator such as is used in house heating: 1-in. pipes lead from this radiator to the hot water heater which is some distance away from the thaw-house, in a separate building entirely, so that there is no chance for the thaw-house to be set on fire. Under no condition use steam to heat the thaw-house. A temperature greater than that of boiling water (212 deg.) should not by any possibility be reached inside the house. Steam at a pressure of 80 lb. has a temperature of 324 deg., and dynamite may explode at 356 deg.

The foregoing are the only methods of thawing dynamite permitted by the Municipal Explosives Commission in New York City, namely, thawing with manure, and thawing in a dry chamber heated by hot water entirely separate from the fire that heats the water.

When but a small amount of explosive is to be used it may be thawed in one of the small thawers manufactured. Several of these are illustrated in Fig. 84. The hot water should never be heated in these kettles as there is often enough nitroglycerin in the cartridge chamber to cause an explosion if the kettle is placed on a fire. Such kettles cost from \$4 to \$10 each.

Elevations and plans for a thaw house recommended by the United States Bureau of Mines for large quantities of dynamite

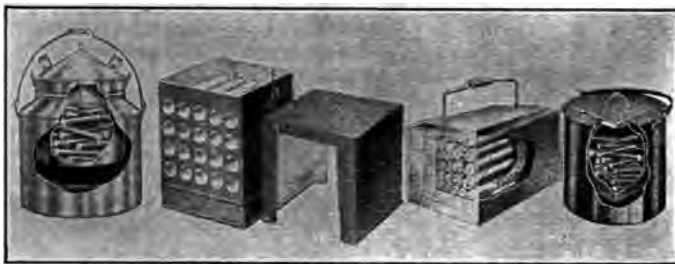

Fig. 84. Small Thawing Kettles.

are given in Figs. 85 and 86. This building should be heated by a small hot-water heater, placed at least 4 yards away, the hot water being passed into the house through iron pipes at such a rate that the temperature in the house will not exceed 90 deg. F. and will average 80 deg. Plans of another thaw house are given in Fig. 89.

Fig. 87 shows a thaw house (used at the Portland Mine, Mich.) such as is advocated in a handbook of the Du Pont Co. This consists of a small wooden building, 4 ft. 6 in. x 6 ft. 3 in., in which the dynamite resting upon sliding racks or drawers is warmed by a current of air passed through a coil of pipe; the pipe contains water heated by a stove some 25 ft. from the house. No matter how hot a fire rages in the stove the current of air can never get dangerously warm. A water barrel placed above the stove and connected to the coil of pipe, maintains plenty of water in the line and allows the heated liquid a place in which to expand; also, the water barrel is convenient in case of fire. The structure should be covered with metal sheeting.

The house is so small that men cannot get inside and smoke. *The walls are packed with 4 in. of sand, therefore the structure is bullet-proof.* To operate, the racks are pulled out and spread *with dynamite, some half dozen boxes being handled at once,*

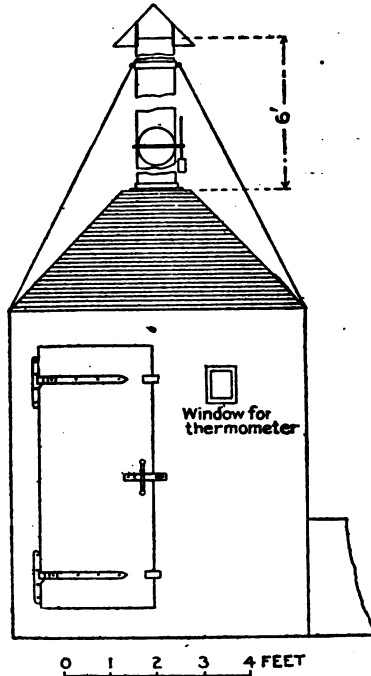

Fig. 85. Elevation of Thaw House for Frozen Explosives.

and a fire is made in the stove. A sliding regulator at the air inlet determines the amount of air used, which is varied according to the temperature. Altogether, the arrangement has been found to be safe, convenient and cheap.

Storage and Handling of Dynamite. The following is an extract from "A Primer on Explosives," by Munroe and Hall:

Dynamite should be stored where the temperature will not be less than 52° nor above 90° F.

Explosives should not be exposed for any length of time to direct sunlight, because this may lead to decomposition in those containing nitroglycerin, nitrocellulose, nitrostarch, or substances of that kind. Explosives should be stored in a dry place, for many of them contain considerable quantities of ammonium nitrate or of sodium nitrate and so will take up moisture from damp air and become damp. Too great dampness makes the explosive *not only harder to fire but weaker when fired.* *Residue*

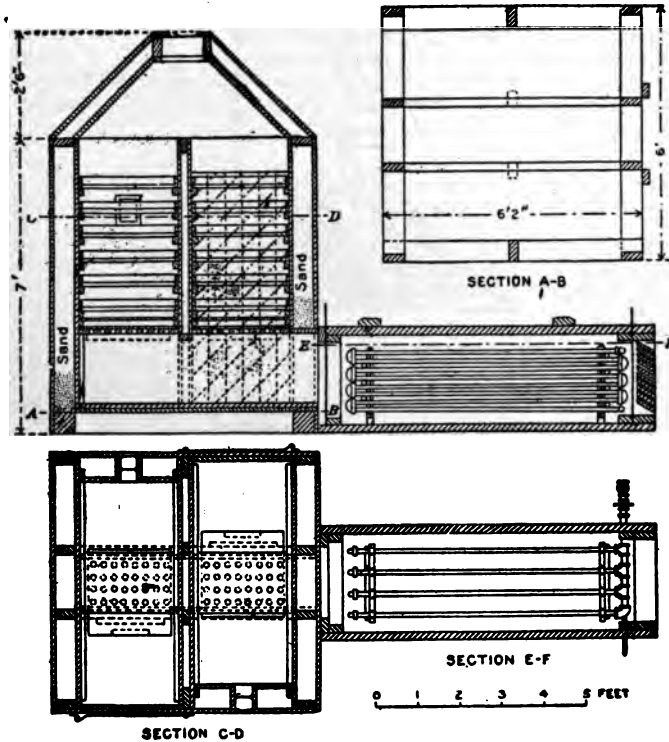

Fig. 86. Section of Thaw House for Frozen Explosives.

if the explosive is damp the nature of the gases produced will be different. Moreover as bodies like dynamite become moist, the nitroglycerin contained in them tends to run out; that is, what is called exudation takes place, and all the dangers follow that belong to liquid nitroglycerin.

On the other hand, explosives should not be kept in an extremely dry place, for all of them as made contain some moisture and if the place of storage is very dry the explosive may lose this moisture. Such a change in composition will affect the explosive so as to change the speed with which the explosive reaction takes place within it, and therefore the character of the work which it does when exploded. Naturally the longer an explosive is kept in storage the greater are the chances that

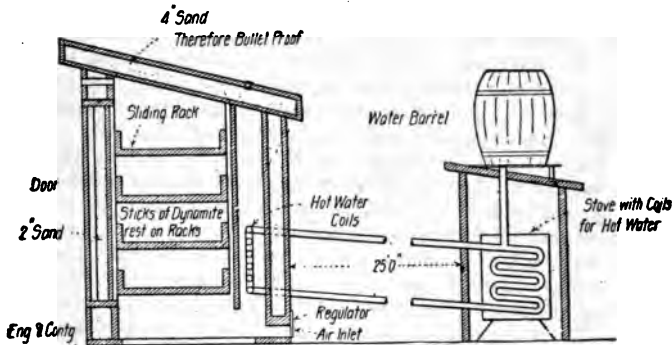

Fig. 87. Thaw House, Portland Mine, Michigan.

change will take place in it, and therefore the explosive should be obtained in as fresh a condition as possible and should be used as soon as possible after it is received. Also it should be kept stored in its original packages in the magazine until wanted for immediate use, and then used promptly.

The paraffine wrapper used in making the dynamite up in sticks is to keep the moisture from the contents of the cartridges. As rough handling readily breaks the folded edges, cartridges should be handled with great care. The necessity for handling cartridges with care to prevent an explosion is pretty well understood, but it is also necessary to handle them carefully to prevent them being spoiled by moisture. They are best carried to the place where they are to be used in the cartons in which they are bought.

Dynamite sticks should never be thrown or dropped, and portions of powder falling from the cartridges must be carefully guarded against friction, blows or fire. It is best that only one kind of explosive be kept in any one magazine. If more than one kind of explosive should be kept in the same magazine, it should be divided into rooms and the different explosives kept in the different rooms. All caps or detonators should be kept in a dry place by themselves and not in a magazine with the explosives.

The greatest care must be taken to prevent packages of explosives from falling or getting shocks. They must not be thrown, dropped, nor rolled. Wooden boxes containing explosives should be opened with extreme care, so as to avoid friction and blows as much as possible. They should never be opened within the magazine, but in a properly sheltered place outside of the magazine and at a distance from it. They should be opened only by the use of a wooden mallet and a hardwood wedge.

Explosives should be protected as far as practicable during storage against heat, moisture, fire, lightning, projectiles, and theft. The buildings should therefore be weather-proof, covered by fire-proof and bullet-proof material, well ventilated, in secluded locations, and not beside grass or underbrush subject to fire risk. Lightning protection is best placed on a line of supports encircling the building and 20 to 30 ft. distant from it. Figs. 88 and 89 show plans of an approved type of magazine.

Magazines should be kept clean and in thorough repair. Grounds around them should be kept clear of leaves, grass, or other materials that might feed a fire. These words should be conspicuously posted on them: "Explosives dangerous. No shooting allowed." The floors must be swept regularly and kept clean. The sweepings should be thrown in water or taken to a safe distance and destroyed.

In case floors become stained with nitroglycerin, cover the stains with dry sawdust, sweep up, and remove the sawdust. Then scrub the stains thoroughly with a hard brush and a solution of one-half pound of sulphide of sodium or sulphide of potassium in one-half gallon of wood alcohol.

Do not allow in the magazine any tools other than a wooden mallet and wooden wedge, or a phosphor-bronze chisel, and a screw driver to be used only for removing screws.

Do not open dynamite boxes with a nail puller or powder cans with pickaxes.

Remove all explosives before repairing a magazine.

Do not store detonators with explosives, especially high explosives.

Do not open packages of explosives in a magazine.

Issue first the oldest explosives on hand.

Do not store dynamite boxes on end, as this increases the danger of nitroglycerin leaking from the cartridges.

From Dana's "Handbook of Construction Plant" I have compiled the following data:

Professor Courtenay de Kalb, in his "Manual of Explosives," says:

"Storage (of explosives) in caves, tunnels, earth or stone covered vaults and in log structures should under no circumstances be tolerated. The chief objection in all these cases is that the structure will hold dampness, and any dampness in a magazine containing any explosive into which nitrates enter as an essential or accessory ingredient is certain to affect its quality and render it more or less dangerous in subsequent use. This applies to gun-powder (common black powder) and to practically all dynamites . . ."

Professor de Kalb recommends a building of tongued and

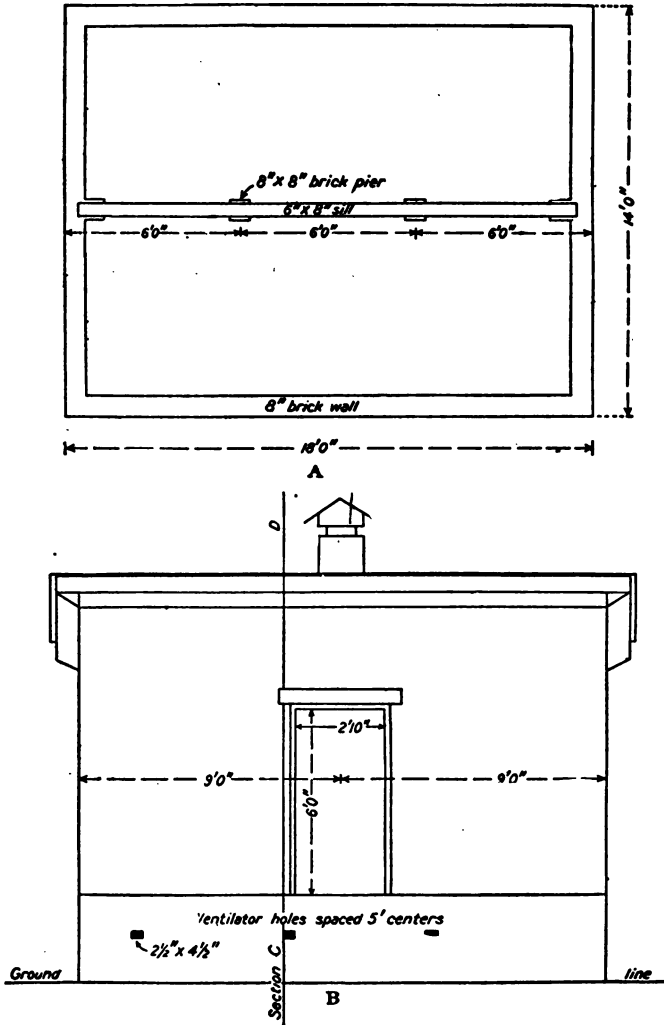

Fig. 88. Front Elevation and Plan of Ventilation of Brick Magazine.

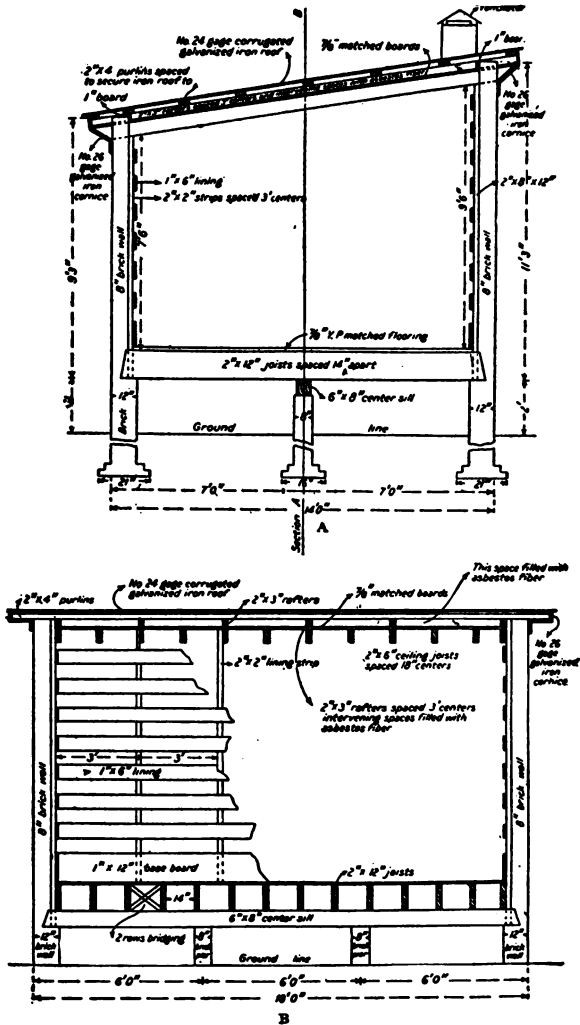

Fig. 89. Sections of Magazine.

grooved boards, blind nailed, with tar-paper covered roof, and if danger of fire is apprehended, steel shingled covered roof and

walls. An ordinary tool box covered with tin or sheet iron and painted red with large, distinct "danger" signs on all sides is excellent. However, it is possible to obtain ready made magazines.

In a recent catalogue of the Du Pont de Nemours Powder Company a number of storage houses are described, and the following data are compiled:

On October 1, 1911, Massachusetts, New Jersey, Ohio, California, and Oklahoma had laws regulating distances at which specific quantities of explosives might be stored with reference to dwellings, public buildings, railroads, etc. Almost all cities and towns have laws regarding this and all who intend to store explosives should inform themselves on all state and local laws. Where no laws affecting storage of explosives are in force, we recommend that magazines be located in compliance with the American Table of Distances, to-wit:

TABLE LIII

Pounds of explosives.	Distances to inhabited buildings when magazine is barricaded (feet).	Distances to unprotected inhabited buildings (feet).	Distances to passenger Ry's when magazine is barricaded (feet).	Distances to unprotected passenger Ry's (feet).
100	180	360	110	220
200	260	520	155	310
300	320	640	190	380
400	360	720	215	430
500	400	800	240	480
600	430	860	260	520
700	460	920	275	550
800	490	980	295	590
900	510	1,020	305	610
1,000	530	1,060	320	640
1,500	600	1,200	360	720
2,000	650	1,300	390	780
3,000	710	1,420	425	850
4,000	750	1,500	450	900
5,000	780	1,560	470	940

Where municipal regulations do not prohibit storing explosives, within city limits, powder or dynamite in quantities of 100 lb. or less may be kept in a small portable magazine. Always mark on this magazine the words "Powder Magazine." Fuse may be kept in a store and blasting caps or electric fuses, not exceeding 500 each. Always keep magazine locked.

Iron Magazines for storing explosives are of two kinds: the portable sidewalk magazine on wheels, and the storage magazine. The former is furnished in five sizes from that with a capacity of eight kegs, size 24 in. x 23 in. x 25 in., weight 150 lb., price \$15 f.o.b. Ohio, to that with a capacity of thirty kegs, size 30 in. x 30 in. x 50 in., weight 450 lb., price \$37. The latter kind comes in ten sizes, from the smallest, capacity 108

kegs, size 30 in. x 30 in. x 50 in., weight 450 lb., price \$37. The largest, capacity 1,848 kegs, size 11 ft. x 8 ft. x 21 ft., weight 4,400 pounds, price \$337.

General Specifications for Sand Filled Dynamite Magazine are as follows:

- Foundations:** If a post foundation is used, posts spaced 5 ft. c. to c. and charred or tarred.
 If brick foundation is used, 9-in. wall stepped to 12 or 15 inch-footing course, all laid with lime or cement mortar.
 If stone foundation is used, wall may be laid dry.
 If concrete foundation is used, wall need not be more than 8 in. thick.
- Floor:** Joists: 2 in. x 6 in., spaced 12 in. c. to c.
 Floor: $\frac{7}{8}$ -in. matched boards, blind nailed, or 1-in. board with nails countersunk.
- Sills and Plates:** 2 x 6 in.
- Studding:** 2 x 6 in.
- Siding:** $\frac{7}{8}$ -in. tongue and groove, or shi lap.
- Lining:** Sheath inside of building from sills to plate with $\frac{7}{8}$ -in. tongue and groove blind nailed, or shi lap with nails countersunk.
- Bullet Proofing:** As inside sheathing is put on fill space between the sill, plate, studding, outside and inside sheathing with coarse sand, well tamped. Do not use gravel or stone.
- Roof:** Rafters: 2 x 4 in., spaced 24 in. c. to c.
 Sheathing, 1-in. plank.
- Roofing:** No. 24 galv. corrugated iron.
- Cornice:** (Under eaves) No. 26 galv. flat iron. To make roof bullet-proof from above, nail plank on rafters and fill with sand.
- Iron Covering:** Sides and ends to be covered with No. 24 or No. 26 black or galv. flat or corrugated iron.
- Door:** 3-in. hardwood, covered on outside by $\frac{3}{8}$ x 62 x 40 in. steel plate. All hinges to be secured by bolts passing through to inside.
- Ventilation:** 3-in. or 4-in. globe ventilator in roof. Ventilator holes to be cut in foundation.

COST.

For storing 1,000 lbs., size 6x6 ft.	\$40 to \$ 60
For storing 2,000 lbs., size 6x7 ft.	50 to 80
For storing 3,000 lbs., size 7x7 ft.	60 to 90
For storing 4,000 lbs., size 7x8 ft.	70 to 100
For storing 5,000 lbs., size 8x8 ft.	80 to 120

Distance from ground to floor, 3 ft. From floor to eaves, 6 feet.

Brick Magazine. These have 8 in. walls, have floors of and are lined with $\frac{7}{8}$ -in. plank, and have roof covered with corrugated galvanized iron.

COST.

For storing 1,000 lbs., size 7x 6 ft.	\$ 60 to \$ 80
For storing 2,000 lbs., size 7x 7 ft.	70 to 100
For storing 3,000 lbs., size 7x 8 ft.	80 to 110
For storing 4,000 lbs., size 7x 9 ft.	90 to 136
For storing 5,000 lbs., size 7x10 ft.	100 to 140

Transportation of Explosives. Explosives may be transported in wagons but care should be used. Exploders and dynamite should never be carried together.

Explosives should never be carried by railroad except in conformity with the rules of the Interstate Commerce Commission. The violation of these laws may subject one to a penalty not to exceed \$2,000 and imprisonment not to exceed 18 months. A copy of these rules can be obtained from any railway agent and information concerning their proper interpretation will be furnished on application to the "Bureau of Explosives, American Railway Association, 24 Park Place, New York City." I quote from a letter of Mr. B. W. Dunn, Chief Inspector of the Bureau.

The rules prescribe in detail the qualities of boxes and kegs used for the shipment of high explosives and black powder, the markings that must be on these packages, the names that must be used in describing the shipments on shipping orders, and the certificate that the shipper must furnish on his shipping order. The explosives must be in proper condition for safe transportation and the packages must be in good order. Unless this be true, and unless all other rules are complied with, the shipper cannot truthfully sign the certificate required from him.

"The manufacturers of explosives and the caretakers of storage magazines throughout the United States are now conversant with these rules and, as a rule, are complying with them. The principal danger of disastrous explosions in transit seems now to accompany the shipments of explosives offered by contractors. Many of these gentlemen obtain explosives in good condition from the factories, or storage magazines, and do not provide proper storage facilities for these explosives while in their possession. Exposure to dampness and to elevated temperatures is liable to cause deterioration in explosive packages and in their contents. The wood pulp and nitrate of soda used as an absorbent for nitroglycerin in dynamite are hygroscopic and will absorb moisture from the air readily. In proportion to this absorption, the nitroglycerin has a tendency to exude from the cartridges. When it does this, it will be absorbed by the wood of the dynamite box and is liable to leak through the joints.

There can be no more serious violation of the rules than to offer for shipment a box of dynamite in this condition. The same kind of exposure results in rusting of black powder cans and the opening of their seams. As soon as a leakage of black powder from one of these packages occurs in a car there are many ways in which ignition of the material can result. In one case loose powder from such leakage escaped through a crack, or nail hole, in the floor of a car in a freight train standing on a siding and the powder was blown by the wind toward the main track. Sparks from the fire box, or the brakes of a passing locomotive, ignited this train and the entire shipment of powder exploded while a passenger car was in the immediate vicinity. All of the passengers in the car were either killed or injured.

"A contractor doing work on a railroad applied to the railway agent for billing to ship his outfit of five cars to another point on the road. He said nothing about having explosives in his outfit. One of his cars contained a large amount of both dynamite and black powder. The car was in bad condition and contained many holes and cracks through which hay, on the floor of the car, protruded and offered an excellent opportunity for ignition by sparks from locomotives. The packages were leaking and a large amount of loose powder was on the floor mixed with this hay. Upon arrival at destination no mention of the contents was made to the agent at that point, and the car was permitted to stand for a number of days on a siding near the main track where it was exposed to this constant danger of ignition from passing locomotives. Through carelessness of the contractor's representatives an explosion did finally occur during the unloading of this car which resulted in the deaths of two men and one child.

"Two cases have been reported recently to the Bureau of Explosives showing the extreme carelessness of contractors that it is hoped this communication will help to remove. One of them shipped on a flat car miscellaneous materials, including a tin bucket containing 14 cartridges of dynamite of high strength. Another contractor shipped a box of tools and placed in this box three boxes containing 50 pounds each of dynamite together with a number of blasting caps. There was nothing in the marking of these packages to indicate the serious violations of the law involved in these shipments.

"It is the intention of the Bureau of Explosives to prosecute vigorously violations of this kind and this letter is written in the hope that it will impress upon contractors generally their *moral and legal* responsibilities in making these shipments."

Efficiency of Frozen Dynamite. The use of dynamite while in *a frozen condition* is not only extremely dangerous but it is also

decidedly uneconomical. Many "lost" holes (holes in which the charges have failed to explode) can be attributed to the frozen state of the dynamite used. I could cite examples of this, but the following records of tests should be sufficient to impress anyone with the economy of using dynamite which has been properly thawed or preserved from freezing.

TABLE LIV. RESULTS OF SMALL LEAD BLOCK TESTS WITH 40% DYNAMITE

(Bulletin 48, Dept. of the Interior, Bureau of Mines).

Physical Condition of Explosive	Grade of Electric Detonator	Class of Explosive "Straight"			
		Low Freezing Dynamite	Nitro-glycerin Dynamite	Ammonia Dynamite	Gelatin Dynamite
		Disruptive Effect	Disruptive Effect	Disruptive Effect	Disruptive Effect
		Per cent.	Per cent.	Per cent.	Per cent.
Thawed, in fresh condition . . .	No. 6	79.4	100.0	88.3	72.9
Frozen, in fresh condition . . .	No. 8	58.4	86.9	69.6
Frozen, 2½% of water added and well mixed	No. 8	42.1	81.3	10.3	4.2
Frozen, 5% of water added and well mixed	No. 8	0.9	7.0	4.2	3.7

Some conclusions drawn from the entire series of tests were that 40% gelatin dynamite should not be used when it is likely to freeze; that stronger detonators should be used in the winter months.

Testing Dynamite for Safety. The outside of dynamite cartridges should not feel greasy, nor should there be a trace of free nitroglycerin inside the wrapper.

The paraffine on the paper will give a somewhat greasy feeling but leaky nitroglycerin is more greasy to the touch. In order to determine whether a stick is leaky, dry it on a clean sheet of brown paper in a room at 60 to 80 deg. F. for about 12 hours. An oily discoloration on the brown paper shows that nitroglycerin has leaked out. Good dynamite will show no such discoloration of the paper. The paraffine on the paper may run and confuse the observer. Taste the paper and this will surely indicate whether or not nitroglycerin has leaked out.

Dynamite that has been frozen and thawed a number of times often leaks, although before the freezing and thawing it did not leak at all. Hence a few sticks should be frozen and thawed three successive times and then tested for leakiness on brown paper as above explained.

Long-continued high pressure will develop leakiness in a

poor quality of dynamite. Hence a few samples should be kept at a temperature of 85 to 90 deg. F. for six consecutive days and nights, and then tested for leakiness on brown paper as above explained.

A whitish crust on dynamite sticks indicates that it has been damp and that the nitrate of soda or potash has leached out (effloresced); and that consequently the dynamite is no longer reliable, and may fail to explode in blasting, beside being dangerous to handle. If the dynamite inside the wrapper shows greenish spots it indicates decomposition of the nitroglycerin, unless it be ammonia dynamite, and consequently is exceedingly dangerous.

A Successful Use of a New Explosive Gelatin, which is not Easily Affected by Cold Weather, in Railroad Construction Work. In railroad contracting work, where the holes are generally vertical and are sprung or chambered a number of times so that they will accommodate the required charge, the holes almost always contain water; generally cold water and sometimes ice cold water. When the blaster begins to load these holes, and the dynamite is plunged into this water and is allowed to remain there while the blaster is loading up the other holes and connecting up, getting ready for the blast, the dynamite has a chance to become very much chilled and possibly even frozen; especially is this true of the holes first loaded.

In some experiments with the new Du Pont Gelatin, on the work of building a trolley line from Lee to Westfield, Mass., under the direction of Superintendent Frank Lee of the Western Massachusetts Contracting Co., several interesting facts were noted with reference to the action of this explosive when cold. Up to the time that the gelatin was tried, blast holes were spaced on 8-ft. squares about 20 to 22 ft. deep and they were sprung until each hole would take 50 or 60 cartridges loaded up to within 8 ft. of the top of the hole. After the first few blasts with the gelatin, it was noticed that the rock was broken up much better, there was less mud-capping to be done and the steam shovels made better progress.

Eventually the distance between the holes was increased from 8 ft. to 10 ft., and finally 12 ft., using exactly the same charge of explosives per hole as before, without any falling off in the thoroughness with which the rock was broken. This rock was hard mica schist, with the stratification lying at an angle of about 45°, and was very wet. The only explanation possible of this great increase in efficiency was that the new explosive, which has a much lower freezing point than ordinary dynamite or gelatin, lost none of its efficiency by being chilled in the cold water.

Detonators and Fuse. See the next Chapter for these and for the prices of explosives.

Tests of Explosives. The United States Government through the Department of the Interior conducts a great number of tests of explosives. The Government, and many manufacturers of explosives, have elaborate plants and laboratories for this work. Tests of explosives under ordinary conditions of use, and by special apparatus, are conducted.

Ballistic Pendulum Tests. The ballistic pendulum is used to measure the propulsive force of explosives. Briefly described, the apparatus may be said to comprise a mortar suspended as a pendulum, a cannon mounted on a truck, and an automatic recording device. The charge to be tested is loaded in the cannon, properly stemmed and exploded. The swing of the mortar is recorded.

A description of homemade apparatus for testing the relative efficiency of explosives is described in the *Trans. Am. Inst. of Min. Engrs.*, Vol. 14, p. 75. This was made by drilling a hole $1\frac{1}{4}$ in. in diameter and $1\frac{3}{4}$ in. deep in the upper part of an old blacksmith's anvil turned upside down. Above the hole was a drilling hammer weighing 9 lb., on one end of an 11 ft. handle. The handle was properly hinged and the whole arrangement braced and guyed so that when a charge was placed in the hole and fired the hammer was thrown up. The strength of the explosives was proportional to the angle described by the handle. Such an apparatus might prove useful in field tests.

Bichel Pressure Gauge. This consists of steel cylinders, air pumps for exhausting air from the cylinders, and an indicator mechanism. The pressure exerted by a charge is automatically recorded, and is determined by formulas. (See Bulletin 48, Dept. of the Interior, Bureau of Mines, for full information.)

Tranzle Lead Blocks. Small lead blocks of certain size are loaded with a known charge, fired, and the expansion of the bore hole measured.

Small Lead Blocks. A charge is placed on top of small cylindrical lead blocks, fired, and the compression of the lead block measured.

Mettegard Recorder and Detonating Fuse. These instruments, described fully in Bulletin 48, are used to measure the rate of detonation of an explosive.

The four systems of apparatus above described are used to measure the disruptive effect of explosives, which bears a close relation to the percussive or shattering force.

From a series of tests described in the before-mentioned Bulletin 48, the following table was prepared.

Class and grade.	Percentage strength representing potential energy	Average percentage strength representing disruptive effect	Average percentage strength representing propulsive effect.
30% "straight" nitroglycerin dynamite	93.1	84.1	96.8
40% "straight" nitroglycerin dynamite	100.0	100.0	100.0
50% "straight" nitroglycerin dynamite	111.0	109.2	107.4
60% "straight" nitroglycerin dynamite	104.0	119.8	114.9
60% strength low-freezing dynamite	60.2	93.5	91.2
40% strength ammonia dynamite	101.8	67.9	99.1
40% strength gelatin dynamite	105.7	78.4	95.8
5% granulated nitroglycerin powder	67.6	21.6	53.3
Black blasting powder ...	71.6	6.8	58.6

Cost of Dynamite at Panama. Records of the Panama Canal show that 55.77% as much dynamite was used during August, September and October, 1910, as for the corresponding months in 1908, and 57.02% as much as in 1909.

The saving for the three months of 1910 over those of 1908, amounts to 431.03 long tons, or \$115,939. The cost of handling, loading and shooting is estimated at \$30.00 per long ton in addition to the cost of the dynamite, or \$12,930 additional saving. The amount of dynamite used per cubic yard of rock excavated has been as follows:

	Long tons dynamite.	Cu. yds. rock.	Pounds explosive per cu. yd.
August, 1908	322.21	907,746	0.796
September, 1908	324.65	1,054,526	0.629
October, 1908	327.75	1,015,143	0.72
August, 1909	297.90	1,043,355	0.64
September, 1909	360.20	1,107,649	0.73
October, 1909	295.20	1,196,297	0.55
August, 1910	191.30	1,177,621	0.36
September, 1910	199.05	1,114,765	0.40
October, 1910	153.23	1,076,678	0.32

CHAPTER X

CHARGING AND FIRING

Kind of Explosive to Use. Whether a high power or a low power explosive is to be preferred depends largely upon the use to which the rock is to be put, as well as upon the strength of the rock itself, the size and spacing of the drill holes, and the character of the work, as open cut or mining. Black powder, with its comparatively slow, heaving action, is used where the material is quite friable, as in mining coal or galena, or in excavating shale, hardpan and the like. It is also used in small charges placed in a row of holes where it is desired to wedge off blocks of "dimension stone" for building purposes.

Hard rocks and ores require a quick powder such as FFF, while the loose shales and soft coals are better blasted with the FF powder. In soft and friable materials it may be best to use F powder as a quick powder will blow a frail material into fragments but fail to bring down any considerable quantity. On the other hand a slow powder should not be used as a rule in seamy ground, where there are clay slips or bedding cracks, as the slow powder loses much of its energy through the escape of its gases into the cracks. As a general rule slow powders are used in large charges and the quick powders in a number of smaller charges.

The ballistic or propulsive effect of powder is less than that of dynamite, but the ratio of the propulsive effect of powder to its disruptive effect is about as 8.6 to 1 as measured at the Pittsburg Station for Testing Explosives (see page 436), while the ratio of the propulsive effect of dynamite to its disruptive effect averages about 1.0. Hence, when it is desired to throw material away from the point of blasting, powder is used instead of dynamite.

Dr. Walter O. Snelling (*Engineering and Contracting*, Jan. 8, 1913) gives tabulations (Table LV) of the total energy of explosives, of percussive and propellent force, and of the toughness of rocks, and suggests that such data may be used to advantage in the selection of the proper explosive to be used in *blasting a rock whose toughness is known* (Table LNI).

TABLE LV. ENERGY OF EXPLOSIVES

Explosive.	Energy in foot tons from 1 lb.	Energy in calories from 1 kg.
Blasting gelatin ¹	1,148	1,640,000
Blasting gelatin ⁴ (7% nitrocellulose)	1,075	1,535,000
Blasting gelatin ⁵ (7.29% nitrocellulose)	1,085	1,551,000
Blasting gelatin ³	996	1,422,000
Nitroglycerin ¹	1,107	1,580,000
Nitroglycerin ⁴	1,029	1,469,800
Nitroglycerin ⁵	1,157	1,652,000
Nitroglycerin ⁷	1,099	1,570,000
Dinitroglycerin ⁵	859	942,000
Dynamite, 75% ¹	903	1,290,000
Dynamite, 75% ¹	819	1,170,000
Gelatine dynamite, 65% ³	925	1,321,000
Gelatine dynamite, 65% ⁴	879	1,267,000
Dynamite, 40% active dope ¹	903	1,290,000
Dynamite, 40% active dope ⁵	864	1,221,400
Dynamite, 30% active dope ⁴	721	1,030,000
Picric acid ¹	567	810,000
Picric acid ⁴	611	873,200
Carbonite No. 1 ²	421	601,000
Donarite ²	585	836,000
Etina coal powder A ²	517	738,300
Etina coal powder B ²	532	760,500
Carbonite No. 1 ²	539	770,100
Carbonite No. 2 ²	498	711,700
Carbonite No. 3 ²	494	705,700
Carbonite No. 1, L. F. ²	481	686,700
Carbonite No. 2, L. F. ²	465	688,200
Coal special No. 1 ²	563	805,000
Coal special No. 2 ²	524	772,500
Coalite No. 1 ²	502	717,400
Coalite No. 2 D ²	553	789,600
Collier powder No. 2 ²	388	696,900
Collier powder No. 4 ²	533	762,200
Collier powder No. 5 ²	603	861,400
Masurite M. L. F. ²	695	992,800
Meteor A X K O ²	427	610,600
Monobel ²	796	1,137,100
Black powder ²	479	685,000
Black powder ³	402	574,000
Black powder, F. F. F. ²	553	789,400
Mercury fulminate	287	410,000
Mercury fulminate	288	411,200
Nitrocellulose (13.30% N ₂) ⁵	743	1,061,000
Nitrocellulose (13% N ₂) ¹	770	1,100,000
Nitrocellulose (13.47% N ₂) ⁴	728	1,039,300
"Pyrocellulose" powder (12.75% N ₂)	671	958,830
Nitrocellulose (12% N ₂) ¹	511	730,000
Nitrocellulose (11.11% N ₂) ¹	557	795,100
E. C. powder ⁵	560	800,000
S. S. powder (English) ⁵	559	799,000
Troisdorf (German) ⁵	660	943,000
Rifleite (English) ⁵	605	864,000
B. N. (French) ⁵	583	833,000
Ballistite (German) ⁵	904	1,291,000
Cordite (English) ⁵	877	1,253,000
Ballistite (Italian and Spanish) ⁵	922	1,317,000

References:

- ¹ = Brunswick.
² = Bureau of Mines.
³ = Bichel.
⁴ = Heise.
⁵ = Gody.
⁶ = Jupiter.

Common Explosives Arranged in the Order of Decreasing Percussive Force and Increasing Propellent Force:

Nitroglycerin.
 Blasting gelatin.
 65% gelatin dynamite.
 60% dynamite, active dope.
 50% dynamite, active dope.
 40% dynamite, active dope.
 30% dynamite, active dope.
 "40%" ammonia dynamite.
 "40%" gelatin dynamite.
 Granular nitroglycerin powder.
 Black powder (fine grained).
 Black powder (coarse grained).

TABLE LVI. TOUGHNESS OF ROCKS

Kind of rock.	Relative toughness. (Limestone = 1)	Foot pounds per sq. foot of fracture
Diabase	3.0	624
Pyroxene quartzite	2.7	562
Sandstone	2.6	541
Altered diabase	2.4	499
Basalt	2.3	479
Hornblende schist	2.1	437
Diorite	2.1	437
Hornblende granite	2.1	437
Rhyolite	2.0	416
Quartzite	1.9	395
Biotite gneiss	1.9	395
Augite-diorite	1.9	395
Altered basalt	1.7	354
Feldspathic sandstone	1.7	354
Gabbro	1.6	333
Chert	1.5	312
Calcareous sandstone	1.5	312
Granite	1.5	312
Slate	1.2	249
Peridotite	1.2	249
Granite-gneiss	1.2	249
Andesite	1.1	229
Limestone	1.0	208
Mica-schist	1.0	208
Amphibolite	1.0	208
Dolomite	1.0	208
Biotite-granite	1.0	208
Augite-syenite	1.0	208
Hornblende gneiss	1.0	208

Selecting an Explosive. Judson powder (which contains a small percentage of nitroglycerin) is considerably more powerful than black powder, and is used in open cut excavation where the rock is of medium strength. It is also used in "chamber blasting," where large charges of it are placed at the end of a small tunnel and a mountain of rock dislodged at one shot. In such cases it will break up very hard rock, leaving it, however, in large chunks.

A high power explosive like dynamite is invariably used in tunnel driving, shaft sinking and open-cut work in tough rock. Specifications usually prohibit the use of dynamite for quarrying dimension stone, because it is apt to shatter the stone. For quarrying stone to be used as rubble, especially if the stone is tough and occurs in massive layers, dynamite can usually be used without danger of injuring the stone. A 40% dynamite is commonly used in open cut work, but with tough rock it often pays to use a 50 to 75% dynamite especially if the rock is to be shattered so that it will pass through a crusher or is to be loaded with a steam shovel.

I have found it advantageous to begin blasting in open cuts by using 40% dynamite. If the rock comes out in too large chunks then to every three sticks of 40% powder use one stick of 75%; and in successive blasts increase the proportion of 75% until the rock comes out in chunks of desirable size. Experiments should also be made in spacing the holes, but of this I will speak more at length later. Having found the proportion of 40% to 75% dynamite yielding the best results, it is possible to order a grade of dynamite that will contain the desired percentage of nitroglycerin. Thus, assuming that the best charge is two sticks of 40% to one stick of 75%, we have:

$$\begin{array}{r} 2 \times 40\% = 80 \\ 1 \times 75\% = 75 \\ \hline 3 \qquad \qquad 155 \end{array}$$

$155 \div 3 = 52\%$, which is approximately the grade of powder to order. If the job is small, one can continue to use a mixture of 40% and 75% dynamite, but on large work it involves too much trouble to use two grades of powder in the same hole. Moreover, the 75% dynamite is far more dangerous to handle, particularly where it must be thawed. Managers and foremen are prone to do all their experimenting by changing the spacing of the drill holes or by changing the weight of the explosive used in the charges, instead of experimenting to determine the most effective grade of explosive to use.

In tunneling, the "cut holes" are frequently charged with 75% dynamite, and the "trimming holes" with 40% dynamite. In tunneling through weak rock, like shale, 40% dynamite will be found powerful enough even for the "cut holes." Vast sums of money are wasted in the mines and quarries of the United States through lack of systematic experimenting to determine the most economic grade of explosive and the most economic spacing of drill holes. By taking the work of blasting temporarily out of the hands of my foreman I have repeatedly succeeded in reducing the "powder bill" from 10% to 35%.

A foreman who can be trusted to select the proper grade of explosive intelligently is "rare."

In mining and tunneling operations, explosives having a high disruptive force and those that produce the minimum amount of poisonous gases are preferable. The black blasting powders, granulated nitroglycerin powders, ammonia dynamites and low-freezing dynamites do not have the requisite disruptive force and produce poisonous gases. Gelatin dynamites have a powerful shattering effect, although not as great as that of nitroglycerin dynamite. However, nitroglycerin dynamite produces poisonous gases in a much greater quantity than does gelatin dynamite, and for this reason the latter is much preferred in tunnel and mine blasting in this country. Tests described by Clarence Hall and Spencer P. Howell in Bulletin 48 of the Bureau of Mines, determined the combustion products evolved by explosives. As a result of these tests a 40% gelatin dynamite of the following formula was manufactured:

	Parts
Nitroglycerin	33
Nitrocellulose	1
Sodium nitrate	54
Combustible material (flour)	11
Calcium carbonate	1
	100

This was tested at the laboratory and in actual mine tests under usual working conditions. The results indicated that all gelatin dynamites for use in mines should be made with an oxygen excess sufficient completely to oxidize all combustible material present, including the paper in which the cartridge is wrapped. Furthermore the results showed that when this class of explosive is properly and completely detonated the proportion of harmful gases evolved is reduced to a minimum.

Charging Black Powder. After pumping out the sludge, the hole is made perfectly dry by a "wiper," using cotton waste or hay held by a spiral twist at the end of the "wiper." The other end of the "wiper" is often provided with a small spoon for scraping out the sludge at the bottom of the hole. If the hole is a small one the powder may be poured through a tin funnel with a long stem reaching to the bottom of the hole, so that none of the powder lodges upon the sides. In large, deep holes no such precautions are taken. If the hole is horizontal the powder may either be shoved in in paper bags, or a long spoon-like scoop may be used to deliver the powder to the end of the hole where it is dumped by revolving the handle of the scoop. A safety fuse should be used (or electric cap), and its lower end should be well buried in the powder. If paper cartridges are used, the end of the fuse is shoved into the powder

and the paper tied around it; but do not pull the string so tightly as to pinch the fuse so as to break the powder thread inside it.

If the hole is a wet one, a waterproof cartridge must be used. To make such a cartridge, fold a long strip of brown paper spirally around a wooden mandril, slightly smaller than the diameter of the drill hole, at its lower end, letting the edges of the paper overlap well. Before removing the paper from the mandril, dip it into melted paraffine, giving it several coats. In a very wet hole another spiral paper wrapping in the reverse direction, well paraffined, will insure dryness. Load this cartridge with powder, attach the fuse and immerse in melted paraffine (113 deg. F.). This cartridge will be perfectly water tight, but cannot be rammed.

After the drill hole is loaded a tamping of clay or sand is used to fill the hole. The kind of tamping has a very great effect, in determining the force of the explosion of black powder.

Tests made by Messrs. Snelling and Hall proved that tamped moist fire clay is the most effective tamping material, with tamped moist sand second best, and untamped dry fire clay least efficient.

Dry clay is first pressed down with a wooden tamp rod. Never use a metal rod and never ram the tamping at the start, for fear of an explosion. Follow with ordinary damp clay pressed firmly to place, and after a thickness of three inches of tamping is over the powder, ram by tapping the end of the tamping rod with a hammer. In holes 1 in. in diam. the charge will not blow out if there are 7 in. of good tamping. In general the tamping will not blow out if it is 7 to 10 times as long as the hole is wide. Nevertheless the tamping should occupy a space of at least three times the length of space occupied by the explosive and should be carried to the surface of the rock if the greatest effect of the powder is desired. If there are any spaces between the powder and the sides of the hole, or between the powder and the tamping, the effect is to cushion the blow of the explosion. In quarrying dimension stone this cushioning effect is sometimes desirable, and it is purposely secured by filling several inches of the hole above the powder with hay, tow or the like, followed by several inches of clay tamped lightly, and finally by well packed tamping. This is called "*expansion tamping*."

In firing black powder by electricity, electric exploders or "electric squibs" of low power are used. There is no advantage in using powerful detonators, because black powder cannot be detonated, but explodes in the same way whether a match or an *electric spark* or another explosive fires it. Electric squibs are *similar in appearance* to electric fuses but have a paper cap

instead of a copper one. The charge does not detonate but the squib merely shoots out a small flame which ignites the powder.

Priming and Charging Dynamite. The charge should fill completely the part of the hole that it occupies, and should be packed solid. Experiments show that even a slight air cushion greatly weakens the force of the explosive blow. Since the sticks of dynamite are slightly smaller in diameter than the hole, the paper of the cartridges (excepting the last one) should be slit lengthwise with a knife and after each stick is dropped or pushed into the hole, press it well home with a wooden rammer. Never cut with a knife or otherwise rupture or break in any way a stick of dynamite that is frozen or partly frozen. Some authorities recommend using a copper blade instead of steel, because the steel might strike a spark if there were any grit in the cartridge.

If there is standing water in the hole do not break the paper of the cartridge, and do not ram, but use a cartridge that will just fill the hole. In wet holes it is well also to daub grease over the cartridge wherever water might enter through a fold in the paper.

The cartridges should never be so large as to require forcing to get them to the bottom of the hole. Remember that a drill hole tapers toward the bottom. Dynamite should never be rammed, but merely pressed home; and a steel or iron tamping rod should never be used for this purpose.

The last stick, or "primer," is provided with either a fuse cap or an electric detonator.

If a fuse is used a common (but wrong) way of loading is first to slip the end of the fuse into the cap, bite the end of the cap shell so as to pinch it upon its fuse; and, if the blaster survives this part of the operation, the next step is to dig a hole in the middle of the dynamite stick with a wire nail; push the cap into the hole and pinch the plastic dynamite around it; take a half-hitch with the fuse around the dynamite cartridge and lower it or push it to place. A cap should never be crimped onto the fuse with anything but a "crimper" made for the purpose. A half-hitch in the fuse is quite apt to break the powder thread inside the fuse and thus cause a misfire. If an electric exploder is used, taking a half-hitch with the fuse wires is apt to result in breaking one of the wires away from the platinum bridge to which it is soldered, and thus causing a misfire. An expert, however, who is skilful and careful may use the half-hitch without causing misfires.

The method of priming recommended in all catalogues of manufacturers is first to open the end of the "primer" cartridge ~~and~~

folding back the paper; then to insert the cap part way into the dynamite after boring a little hole in the dynamite with a wooden stick with a rounded point. However, this operation should never be attempted when the cartridge is frozen and hard. The cap is left projecting about $\frac{1}{8}$ in. above the dynamite, so that by no chance can the fuse set fire to the dynamite and thus reduce the force of the explosion. The ends of the paper cartridge are drawn up around the fuse or the fuse wires, and tied with a string (as in Fig. 90), one end of the string being left long enough to let the "primer" down to the bottom of the drill hole. The cap should fit tightly in the dynamite, for even a slight air space will serve as a cushion to reduce its force and so weaken the force of the final explosion. In wet holes, smear grease around the end of the cap. The end of the fuse should be cut square across, preferably with a "fuse cutter," and then, holding the fuse upright, slip the cap over it. It should require no effort at all to slip the cap on, for either pressing or twisting the cap on may explode it. If the fuse is too large whittle it down with a knife; if too small, wrap paper around it. Crimp the shell of the cap about $\frac{1}{8}$ in. from its end with the "crimper," which is combined with the "fuse cutter." At the other end of the fuse cut a slit $\frac{1}{2}$ in. long to expose the powder core for lighting with a candle flame or torch. Dry paper may be twisted around the end to insure lighting, but it is not good practice to soak cloth or waste in oil and wrap it around the fuse. Of course the end of the fuse should not be allowed to drop into water, at least not until the fire inside has crept some distance down into the fuse. The "primer" should not be lowered into the hole by the fuse, because in this way the cap is often pulled loose leaving an air cushion that greatly reduces the force of the explosion. When the "primer" has been lowered it should never be compressed or rammed; but the tamping should be placed upon it immediately.

In some cases it is advantageous to charge a hole with powder and dynamite together. If a black powder igniter is used to explode the powder, the exploding powder will in turn detonate the dynamite, and there is no necessity of placing a detonator in the dynamite; in fact the practice of using a detonator in such cases is often dangerous. When squibs are used for firing black powder, it is necessary to insert a needle into the charge of powder, and this needle may strike the detonator and cause a premature explosion.

To emphasize the importance of inserting a cap and fuse in the end rather than in the side of a stick, a quotation from a paper by Mr. A. W. Warwick in *Mines and Minerals* will serve: "There was no doubt in my mind, after studying the method

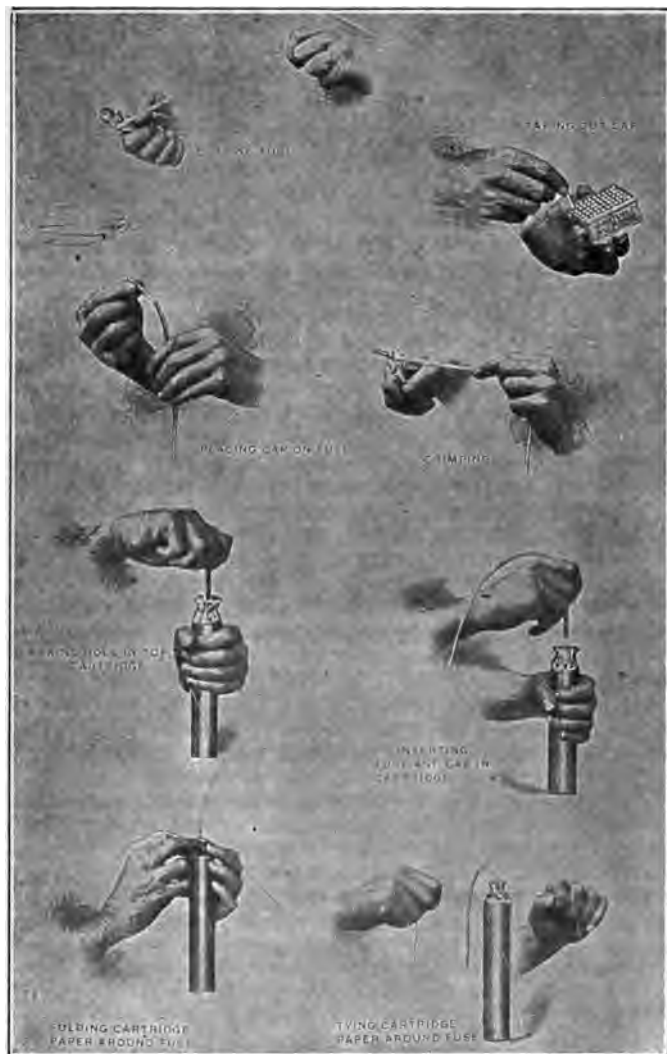

Fig. 90. Priming With a Fuse Cap (Du Pont).

of loading, that there was a possibility of the burning fuse setting fire to the dynamite cartridge on top of the primer before exploding the cap. In order to see if this were the case or not, a piece of pipe 12 in. in length and $\frac{3}{4}$ in. in diameter was obtained, a piece of fuse was passed through and a cork was forced in so as to hold the dynamite; a stick of dynamite was squeezed into the pipe and held in place by a plug. The fuse was fired and developments were awaited at a respectful distance. Out of seventeen experiments six resulted in an explosion. The fumes from the explosion were very acrid, dense and rather ruddy in color. The nitroglycerin was fired by heat and not by detonation, and the fumes had the appearance and odor of fumes generated by incomplete combustion."

The force of a cap is mainly forward from the fuse or wires. If a cap is pointed at a stick several inches away it will explode it; if pointed to one side it will not explode it. Mr. George C. McFarlane says: "The detonating cap should be placed in that part of the charge furthest from the point where the greatest energy is needed as the explosion of the cap uses a portion of the powder to explode the remainder of the charge, hence the usefulness of part of the powder near the cap as far as its rock rending qualities are concerned, is destroyed. With a 'cut hole,' where the powder is needed at the toe of the hole, a cap on top of the charge will tend to put the locus of the principal concussion nearer the bottom of the hole."

Tamping. The best tamping or "stemming" is well tamped moist clay; well tamped sand ranks second. Even where sand is used for the major portion of the hole it will pay to use clay balls for the first foot or so, the clay being moist enough to roll into pellets. A handful or two of sand may be poured into the hole first to cover the "primer"; and then follow with clay. The clay pellets should be lightly compressed for the first 6 in., and above that the tamping may be compressed with increasing force. Sand is generally used for tamping above the first foot or two because it can be poured in with much greater rapidity. I would suggest pouring enough water into the hole after the sand is in to dampen it, for damp sand arches better than dry sand and better resists the pressure. Experimenting with different kinds of tamping on any given class of work is time and money well spent, for it is not a fact that dynamite needs no tamping, or that water makes a good tamping. Mr. W. L. Saunders is authority for the statement that one pound of dynamite under a water tamping will not do as much execution as one-quarter of a pound in dry blasting. Bear in mind *that tamping is cheaper than dynamite even if several dollars a ton are paid for tamping.*

It will pay to have on hand a number of clay plugs $1\frac{1}{2}$ in. in diameter and 4 to 6 in. long, where quick tamping is desired. To load the plugs wrap a piece of paper around one end, shove in the hole and ram tight. While working the tamping rod with the right hand, hold the fuse or the fuse wires with the left hand so as to detect and thus avoid rubbing the fuse with the tamping rod. Some blasters use a tamping rod with a beveled end, and hold the rod so that the sharp edge of the bevel is always on the side of the hole farthest from the fuse. To know which side the sharp end is on, cut a longitudinal groove in the tamping rod.

Some authorities recommend placing the "primer" at the bottom of the charge, instead of at the top; others say that the "primer" should be placed at the middle of the hole. Dynamite explodes with such suddenness that we may well doubt whether it makes any difference at all where the primer is placed, so far as the execution is concerned.

It is often advisable, in deep holes, to place the dynamite in several distinct charges separated by tamping, and in this case each charge should have its own cap and "primer"; but this is a matter quite aside from the present discussion and will be taken up later. In long hole charges the primer is often placed at the top with other caps at 5 ft. intervals.

Handling dynamite sticks with the bare hands will give a headache to anyone not used to it, because of the nitroglycerin absorbed through the pores of the skin. The obvious preventative is to wear gloves.

Charging Judson Powder. Contractors' powder and Judson powder are charged like black powder, but they are fired by using a "primer" consisting of a stick of dynamite in which a blasting cap is imbedded.

Firing by Electricity. In New York City it is compulsory to fire all blasts by electricity on account of the greater safety of electric firing. Electric firing is not only safer than fuse firing, but, in open cut work especially, it is more effective, because the simultaneous explosion of charges in a row of holes obviously reduces the work to be done by each charge as compared with fuse firing by which one charge explodes in advance of the neighboring charge. In tunneling, where the center cut holes must be fired in advance of the outer holes, it will probably continue to be the practice to fire by fuse, using fuses of different lengths so as to regulate the order in which the charges in the different holes will explode, but there are few places outside of tunnels and shafts where fuse firing is preferable to electric firing from any point of view; and even in *tunnel work there are many blasters who prefer electric firing.*



Fig. 91. Different Methods of Inserting an Electric Detonator (Aetna).

With the electric system charges may be exploded in sequence in the usual manner of separate firing or by using "delay electric fuses." These are known as "No Delay," "First Delay" and "Second Delay."

"No Delay" fuses detonate the instant the electric current passes through them, whereas "First Delay" and "Second Delay" fuses contain a slow-burning substance which is ignited by the electric spark. After burning a short time this substance ignites the detonating composition. This type of fuse has not always given perfect satisfaction because the slow-burning substance cannot be made absolutely uniform and the charges on one set of fuses do not explode simultaneously.

Fig. 91 illustrates the various methods of priming a cartridge with an electric detonator. When the hole is made as in A it leaves the detonator in the center of the cartridge and this is advantageous in wet holes as the dynamite may be squeezed close around the wires thus keeping the water out. When the hole is made in the side it may extend nearly through the cartridge and the detonator may rub against the walls of the drill hole. Similarly when placed as in D the detonator may be drawn into the position shown in E. Never have the fuse through the cartridge as the sharp bends may cause breakage and consequent misfires.

The fuse wires attached to each cap are furnished by the manufacturers in varying lengths to suit varying depths of drill holes; but it is not necessary to have fuse wires that will reach to the mouth of the drill hole, for connecting wires may be spliced on to the ends of the fuse wires and the splice wrapped with insulating tape. When a splice is to be made thus, it is well to cut 3 or 4 in. off one of the fuse wires so that one splice will not come directly opposite the other; for when this is done it is necessary to wrap insulating tape around one of the splices only, and it is not necessary to wrap even one splice except in damp holes. A splice is made by cutting the insulating material away for 2 or 3 in. back of the ends of the wires to be joined, scraping the wires until they are bright, and twisting the clean wires together, as shown in Fig. 92.

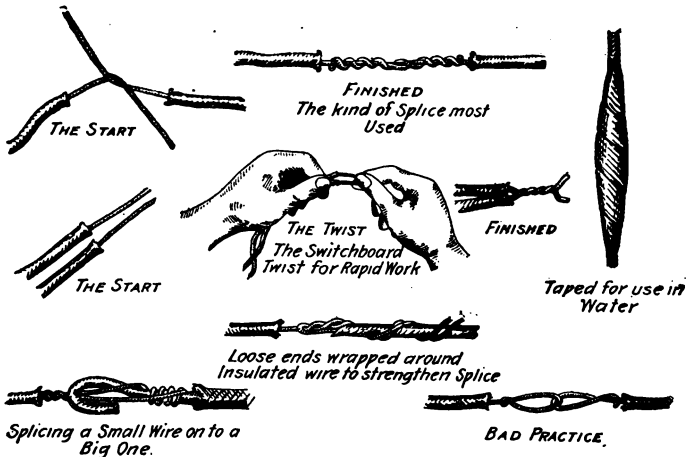

Fig. 92. Methods of Splicing Wires (Ætna).

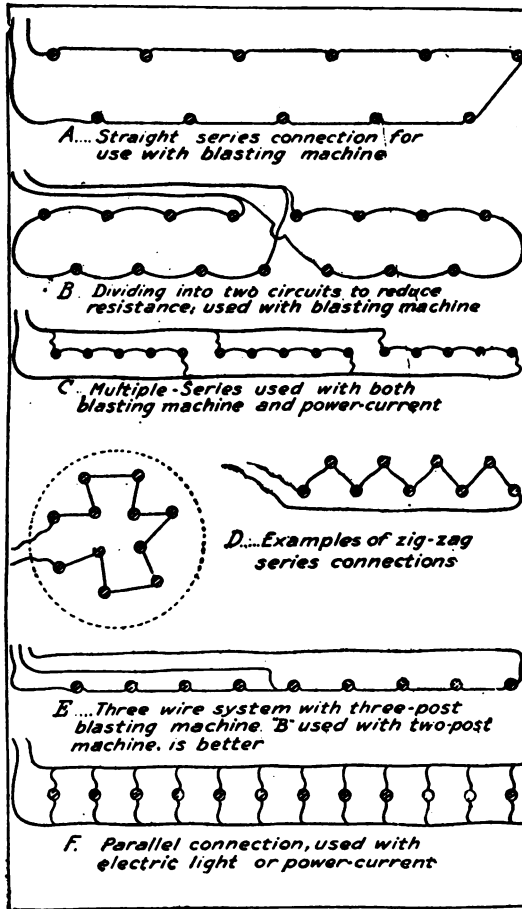

Fig. 93. Methods of Wiring.

Insulating tape is $\frac{1}{2}$ to $\frac{3}{4}$ in. wide and comes in $\frac{1}{2}$ -lb. rolls. It is often used to cover splices made in connecting wires when the splice comes in contact with moist rock or earth. Practically no electricity can leak through dry rock or earth, so that there is no necessity of insulating the splices unless the bare wire is apt to come in contact with moist earth or water. Then support the joints on dry stones. The fuse wires

from each hole are connected (by "*connecting wires*") right and left with the fuse wires from the neighboring holes, so as to form a continuous circuit with the holes in series (Fig. 93); then the end of one fuse wire of the hole on the extreme left is connected with a "*leading wire*" that runs to the electric battery, and in like manner the other "*leading wire*" from the battery is connected with one fuse wire of the hole on the extreme right. This final connection should not be made at the battery until all workmen are at a safe distance. When it is made, lift the handle of the battery and press it down, at first with moderate speed, but finishing with full force. The leading wires must be long enough so that the electric battery is 200 to 500 ft. away from the blast, and in a direction back of the face (in open cut work). The sun should not shine in the eyes of the blaster, for he should be able to see and dodge any falling fragments of rock. It is well to wind the two leading wires together into one cable, separating them only for a short distance from the blast; then, after firing, this cable can be wound up on a reel. As the copper connecting wires are expensive, the blaster should collect all fragments of wire after each blast and wind them upon a reel to be spliced and used again.

For firing by electric light or power current the charges should be connected in parallel (Fig. 93), and the size of wires needed should be calculated as are the size of wires for electric light circuits. Each electric detonator should receive the same current in amperes as one 16 c.p. 110 volt lamp or one 32 c.p. 220 volt lamp.

Misfires. A misfire when an electric battery is used may be due to any one of several causes: (1) A blasting cap may be defective, due to the fact that water has penetrated the cap or to the fact that the platinum bridge in the cap has become unsoldered; (2) caps of different makes or strengths used in the same charge will cause trouble; (3) short-circuiting may be caused by a half-hitch taken with the fuse wire around the primer (which is a poor but common practice) which may have broken the insulation so as to permit the electric current to pass from one wire to the other without passing through the cap; but in this case charges in all other holes of the series will explode; (4) a defective splice in the connecting wires may have broken the circuit; (5) a fuse wire may have been broken in the process of tamping; (6) the battery may be improperly operated or may be overloaded.

This last cause is one of the most common causes of misfiring. Any given battery will explode a limited number of caps in series through a given number of feet of copper wire.

given diameter. Increase the number of caps, or increase the length of wire, or decrease the diameter of the wire, and the battery will fail to explode the caps. The copper of the leading wires should be at least twice as thick as that of the connecting wires in order to reduce the resistance to the passage of the current as far as possible. Never load a battery up to its limit, but have a good margin of surety that it will explode all the caps in the series. Saunders is authority for the statement that a weak battery may explode part of the caps and leave the rest unexploded, due to variations in the resistance of the platinum bridges in the caps.

"In case of a misfire no one should approach the holes for half an hour if electric firing is used, and not for several hours if fuse firing is used." This is the rule laid down by several authorities; but it is doubtful whether it is ever followed in practice. I fail to see any good reason for waiting more than a few minutes after a misfire by electricity; but with a fuse there is always danger that the flame may smoulder and creep slowly past some break in the powder thread and finally explode the cap.

After waiting some time it may be necessary to remove part of the tamping in the hole and put down another "primer." This is a dangerous operation at best, and if black powder is used a copper or wooden (never steel) spoon should be used in removing the tamping. In any case never remove the tamping entirely, but leave the 3 or 4 in. of the cushion tamping above the charge in place. Then place several sticks of dynamite and a "primer" on top of the first charge and fire again. The New York City rules forbid removing tamping at all, and require that a new hole shall be drilled not closer than 12 in. to the old hole, and that in this new hole a heavy charge be loaded and fired. Whenever an explosion fails to carry away the rock clear to the bottom of a drill hole it is forbidden to begin drilling in the bottom of the old drill hole, as part of the former charge may remain unexploded in the bottom of the old hole and explode under the blows of the drill. I question whether it is always safe practice to drill a new hole within a few inches of an old hole, hoping to be able to explode the charge in the old hole by a blast in the new hole. A safer practice, which I have followed in open-cut work, is to drill the new hole several feet from the old hole and to a depth that will bring the bottom of the new hole on a level with the top of the charge in the old hole. Then upon blasting the new hole the shattered rock around the old hole may be removed, the dynamite exposed, a cap inserted and fired.

Do not blow unexploded dynamite out of a hole with a jet of steam. Use air.

Blasting Battery. A blasting battery, usually called a “blasting machine,” is a hand-operated dynamo and in general consists of two electro-magnets and an armature (Fig. 94). The machines are built either “push-down” or “pull-up,” that is, for operation by pushing down or pulling up a handle. The “push-down” machine is the commonly used type. The act of pushing or pulling the handle generates a powerful electric current which

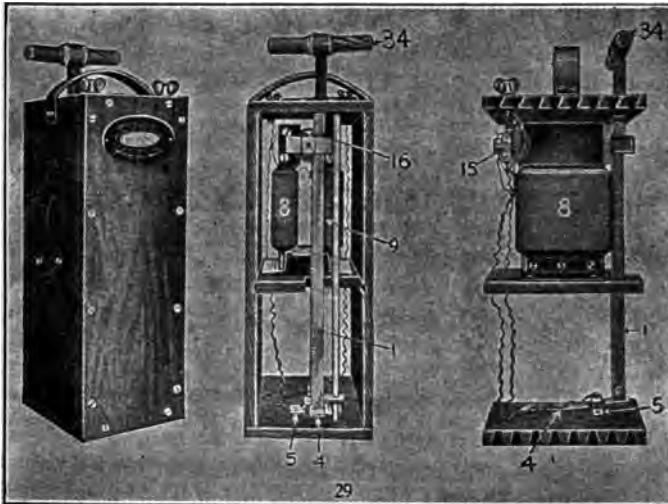

Fig. 94. Two-Post Blasting Machine (Du Pont).

is stored up during the movement of the handle, and is short-circuited or discharged into the blast line at the end of the stroke. The stroke should be continuous and strong to the end or a misfire may result. The quicker the stroke, the stronger the current generated. The handle should not be churned up and down, but should be moved slowly the first half inch and then with all the force possible.

Du Pont “push-down” machines are manufactured in two sizes as follows:

	No. 2 (2 Posts only)	No. 3 (2 Posts, unless specially ordered with 3 Posts)
Capacity	1 to 10 Electric Fuses.	1 to 30 Electric Fuses.
Dimensions	7" × 8" × 14"	7" × 10" × 18"
Net weight	20 lbs.	25 lbs.
Weight, boxed for shipment	25 lbs.	30 lbs.
Price, about	\$10	\$15

"Pull up" blasting machines are manufactured in No. 5 size only, as follows:

	No. 5 (3 Posts only)
Capacity	1 to 100 Electric Fuses.
Dimensions	12" X 14" X 23"
Net weight	50 lb.
Weight, boxed for shipment	65 lb.
Price, about	\$45

The Lion machines are rated at the number of 4-ft. detonators they will ordinarily fire. Allowance should be made when longer wires are used. These machines are manufactured in 4 sizes as follows:

Size	No. 1	No. 3	No. 4	No. 5
Capacity, hole	8-10	20-25	30-35	50-100
Weight, lb.	18½	22½	45½	66½

Blasting machines are generally strongly made and will stand fairly hard treatment. However, like all machines, they require a certain amount of care. Machines should be kept in a dry place and the commutators and brushes occasionally sand-papered. Don't use emery.

The bearings and gearings should be lightly oiled occasionally but the commutator should never receive any oil but only a little graphite. The little slots in the commutator should be scraped clean as any particles of metal may cause a short circuit. The copper brushes should be kept clean and should bear firmly on the commutator. The contact points should be kept clean and bright.

A blasting machine should be tested from time to time, either by firing its full quota of detonators or by lighting an electric incandescent lamp. A bright flash in the lamp indicates that the machine is in good condition.

Do not overload a blasting machine.

Do not leave a blasting machine exposed to the weather.

The "two-post" machine (Fig. 94) is the type commonly used, but where a very large number of holes (30 to 100) are to be fired simultaneously a "three-post" machine is used. With a "three-post" machine, a three wire system (Fig. 93E) is used. This splitting of the circuit makes it less likely that any of the fuses at the middle of the circuit will fail to explode. Of course a "three-post" machine can also be used with only two leading wires, one of which is connected with the middle post.

Methods of Firing. Black powder is exploded by direct contact with any incandescent substance, such as the burning train of powder of a safety fuse; but dynamite, Judson and contractor's powder are exploded only by detonators, or "caps."

as they are commonly called; the cap in turn being exploded either by a safety fuse or by an electric current. There is absolutely no advantage in using a cap to explode black powder, for it will not produce any greater effect. Black powder cannot be detonated, but always explodes slowly.

Miners' Squibs. These were formerly short lengths of powder filled straws one of which was inserted in a hole bored through the "stemming" material to the charge by a metallic needle, used to explode black powder. One of these straws, when ignited and propelled by the force of the burning powder, would dart from the mouth of the drill hole to the charge of explosive through the opening made with the needle, and would ignite the charge when the core of powder had burned through.

Modern Miners' Squibs consist of small paper tubes 4 in. long filled with powder and having at one end a slow-burning paper taper or match. There are two kinds in general use in the United States: One is commonly known as a gas squib which glows throughout its length when ignited and does not flame: the other is commonly known as a sulphur squib which burns with a flame. According to Hall and Howell (Technical Paper 7, Department of the Interior, Bureau of Mines), the average time of burning of a gas squib was 57 sec. and of a sulphur squib was 34 sec.

Safety Fuse. William Bickford, of Cornwall, patented his justly celebrated safety fuse in 1831. It consists of a powder thread around which is spun jute yarn, which is afterward waterproofed with coal tar. The core of powder is so tightly compressed in a thin thread that the fire travels along it slowly, the rate in a good fuse being 2 ft. per min. Single fuses have only one layer of waterproof yarn around the powder: double fuses have two layers of waterproof yarn. Tape fuses are wound with waterproof tape, overlapping. In wet holes double fuse and tape fuse are used. For blasting under water gutta-percha covered fuse is used.

Safety fuse may be used with blasting caps to detonate high explosives when it is not necessary to fire more than one charge at a time, or, without caps, to explode powder. Fuse should be handled carefully and stored in a cool, dry place. If frozen it should be thawed. Cold causes it to become brittle and it may break when handled. Extreme heat softens the varnish, causing it to penetrate the powder, and may make it fail to burn. Oil or greases may cause the same result. In uncoiling fuse, do so from the inside of the roll.

The rate of burning of fuse sold in the United States ranges from 1 ft. in 18 sec. to 1 ft. in 40 sec. when burned in the open air. Under ordinary conditions the variation in the rate of

burning is less than 20%. According to Snelling and Cope (Technical Paper 6 (1912) U. S. Bureau of Mines) fuse under pressure will burn at a rate of three or four times as fast as its normal rate. High temperature, on the other hand, may cause fuse to burn from three to five times as slowly as under normal conditions. Damp fuse also burns slowly. Fuse that has been hammered or pounded so as to abrade it, may burn with great rapidity. Under varying conditions fuse may burn as rapidly as 1 ft. per sec. or as slowly as 1 ft. in 40 sec.

Detonators or Caps. A cap (also called a blasting cap, a detonator, or an exploder) for exploding dynamite consists ordinarily of a mixture of mercury fulminate and potassium nitrate or chlorate placed in a small copper capsule, the open end of which is plugged with sulphur, if the cap is one made to be fired with electricity; but if the cap is to be fired with a fuse the fulminate is covered with shellac, collodion, thin copper foil or paper, and the end of the capsule is left open to receive the end of the fuse. Caps for use with a fuse are $1\frac{1}{4}$ to $1\frac{1}{8}$ in. long and of .22 caliber.

Caps are commonly graded according to the amount of fulminate in the cap. Formerly the grades were:

Single strength (X.)	3	grains of mercury fulminate
Double strength (XX.)	6	" " " "
Treble strength (XXX.)	9	" " " "
Quadruple strength (XXXX.)	12	" " " "
And so on.			

In England the manufacturers are compelled to grade their caps as follows, and in America this same grading is now used (although not enforced by law):

Grade of Cap	No. 1	No. 2	No. 3	No. 4	No. 5	No. 6	No. 7	No. 8
Fulminate, grs.	4.9	6.2	8.3	10.0	12.3	15.4	23.1	30.9

Fulminate of mercury when heated to 367 deg. F., or when forcibly struck, explodes with great violence. The presence of a small per cent. of moisture prevents explosion; hence caps stored in a damp place, as underground, deteriorate rapidly. Mr. W. J. Orsman has shown conclusively how quickly caps deteriorate in a damp place by placing a few caps in a bottle on top of some damp saw-dust. In 24 hr. the caps had absorbed 0.1% moisture; in 14 days, 0.4%; in 22 days, 0.5%. After 40 hr. the caps failed to explode dynamite, although they would still explode themselves.

Mr. A. W. Warwick has shown how important it is to use powerful caps in exploding dynamite to get the best results. To test the strength of caps he recommends standing a cap on a sheet of lead $1\frac{1}{2}$ x $1\frac{1}{2}$ in. x $\frac{1}{8}$ to $\frac{1}{4}$ in. thick, enclosing it with a pipe and exploding it. A strong cap will pulverize the cop-

per shell and the particles of the shell will make fine marks in the lead, around the deep hole left where the cap stood. A weak cap will not pulverize the copper shell, but will tear it into larger pieces, which make large marks in the lead around a shallower hole where the cap stood.

The stronger the cap the more powerful will be the explosion of the dynamite. This is well shown by the following tests made by Mr. Warwick and published in *Mines and Minerals* (Sept. and Oct., 1902, Feb., 1904).

The dynamite was tested with the "Abel block." An "Abel block" is a cylindrical piece of lead, 5 in. diameter by 5 in. high, with a 3/4-in. hole, 2 1/2 in. deep, in which a charge of 5 grams of dynamite is placed in the form of a small tissue paper enclosed cartridge. The cartridge with its cap is pushed home and tamped with sand that has passed a 60-mesh screen. The block is placed between two 1 x 6 x 6-in. iron plates and the whole held together with two iron rings, 1 1/2 x 1 1/2-in. section, and securely wedged. The fuse is fired and the resulting cavity in the lead is measured by pouring in water, then by deducting the volume of the original 3/4-in. bore hole, the increased volume due to the explosive is ascertained in cubic centimeters. To determine the theoretical efficiency a simple proportion serves:

$$35\% \text{ powder} : 40\% \text{ powder} :: 129.3 \text{ cu. cm.} : 141.2 \text{ cu. cm.}$$

Careful tests showed variation not exceeding 4% in the effectiveness of samples taken from different parts of the same commercial stick of dynamite, while even less variation was found in sticks taken from various parts of different boxes. This leads to the very important conclusion that misfires in mining or quarrying cannot be attributed to lack of uniformity of cartridges, when the dynamite is not frozen. Tests on two different makes of dynamite showed the effectiveness of varying percentages of nitroglycerin thus:

30 per cent. dynamite35.3	35 per cent. dynamite44.5
40 " " "43.1	40 " " "47.6
60 " " "61.7	60 " " "63.3

These results show conclusively that the absorbent dope of low-grade powders adds materially to their effectiveness.

Another set of experiments was made to show the relative strength of a given dynamite using different strength of caps:

		3x cap.	4x cap.	5x cap.
35 per cent. dynamite	37.4	40.2	44.7
40 " " "	40.9	41.6	46.8
60 " " "	59.7	62.2	63.3

From which we see that with 35% dynamite, the 5x cap gives 19 1/2% increased efficiency as compared with the 3x cap; with

40% powder, 15% increased efficiency; 60% powder, not quite 6% increased efficiency.

As a further confirmation of these tests the running of three cross-cut drifts in diabase showed similar results. The drilling was done by hand hammers with $\frac{7}{8}$ -in. drills, and 40% dynamite was used. The work was done in winter when the outside temperature was many degrees below zero. The different caps were used for one week in each of the three drifts, and the advance carefully measured. The "duty" of the dynamite was measured in cubic feet of rock loosened by a pound of dynamite, and was as follows:

	3x caps.	4x caps.	5x caps.
Drift No. 1	19.4	23.5	22.8
" No. 2	17.6	24.2	25.1
" No. 3	18.7	22.6	23.7
Average "duty"	18.6	23.4	23.8
Cost per ft. of drift	\$6.34	\$5.75	\$5.72

As a result of these tests, 5x caps were used in winter and 4x caps in summer. When the 3x caps were used the dynamite fumes were so bad as to make it impossible for the men to work well.

Do not use caps of different makes in the same charge.

Electric Detonators. The electric detonator or "platinum fuse," as it is called by some makers, has a composition similar to the fuse cap described in the previous paragraph, and all that is there given regarding strength and use of caps applies to the electric cap, or "fuse." Fig. 95 shows an electric

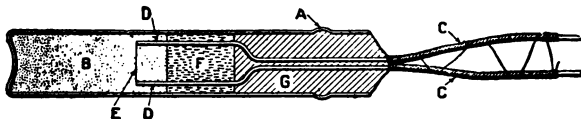

Fig. 95. Electric Detonator.

cap in which A is the shell of copper, having a corrugation thrown out from the inside, which holds the composition plug more firmly in place; B is the chamber containing the explosive charge; C, the insulated copper wires entering the cap; D, the bare ends of the copper wires, projecting through the plug into the charge; E, the small platinum wire or "bridge" soldered to and connecting the two ends of the copper wires, which is heated by the electric current; F, the composition plug holding the fuse wires firmly in place; G, the filling material.

The bridge is embedded in finely chopped guncotton which ignites the fulminate. Some makers use gunpowder instead of guncotton, but it is claimed that then there is more danger of

breaking the platinum bridge by rough handling. This platinum "bridge" is heated red hot when the electric current passes through the wires, and thus explodes the fulminate of mercury. The fuse wires, C, are 4 ft. to 30 ft. long, depending upon the depth of the blast hole. They are insulated with cotton. The ends of these fuse wires are connected to "connecting wires" that reach from hole to hole.

The sulphur plug (F) does not make detonators entirely waterproof, for the copper of the shell expands more than the sulphur upon any rise of temperature in the air, and thus opens a slight crack through which moisture may reach the fulminate of mercury. Shoemakers' wax, warmed, then cooled until jelly like, if daubed around the end of the exploder, will keep out water when using exploders in wet holes. Tallow may also be used, but is not so effective.

In nine cases out of ten, failure to explode a series of holes by electricity is due to a defective exploder. The cause may be moisture that has reached the mercury fulminate while the caps were stored or after charging in the hole; or it may be that the platinum bridge has broken from the copper fuse wires. Care should be taken never to pull hard upon the fuse wires, for fear of loosening the platinum bridge.

Prices of Blasting Supplies. The following data have been taken from Dana's "Handbook of Construction Plant." These prices were normal before the European War.

ELECTRIC FUSE.

(Copper wires.) List prices per 100.

Length of wire, ft.	Weight of charge			
	No. 4. (Single strength.) 10.03 grains or .65 gramme.	No. 6. (Double strength.) 15.43 grains or 1.00 gramme.	No. 7. 23.15 grains or 1.50 grammes.	No. 8. 30.86 grains or 2.00 grammes.
4	\$ 3.00	\$ 3.50	\$ 4.00	\$ 4.50
6	3.54	4.04	4.54	5.04
8	4.08	4.58	5.08	5.58
10	4.62	5.12	5.62	6.12
12	5.16	5.66	6.16	6.66
14	5.70	6.20	6.70	7.20
16	6.24	6.74	7.24	7.74
18	6.78	7.28	7.78	8.28
20	7.32	7.82	8.32	8.82
22	8.32	8.82	9.32	9.82
24	9.32	9.82	10.32	10.82
26	10.32	10.82	11.32	11.82
28	11.32	11.82	12.32	12.82
30	12.32	12.82	13.32	13.82

Longer lengths (made to order), \$1.00 for each additional 2 feet.

The discount from above is about as follows:

5,000 or over, delivered	25%
1,000 or over, factory	15%
Less than 1,000, factory	10%

BLASTING MACHINES

Brand.	Maximum Capacity.	Weight		Price
		Gross	Net	
Du Pont Pocket Battery *	3 Electric Fuses	5 lb.	2 1/4 lb.	\$ 2.50
No. 0	4 Electric Fuses	13 lb.	9 lb.	12.50
No. 2 Reliable	10 Electric Fuses	25 lb.	20 lb.	10.00
No. 3 Reliable	30 Electric Fuses	30 lb.	25 lb.	15.00
No. 3 U. S. Standard	30 Electric Fuses	30 lb.	25 lb.	15.00
No. 4 Reliable	50 Electric Fuses	50 lb.	45 lb.	30.00
No. 4 U. S. Standard	50 Electric Fuses	50 lb.	45 lb.	30.00
No. 5 Pull Up	30 Electric Fuses	40 lb.	33 lb.	15.00
No. 4 Pull Up	50 Electric Fuses	60 lb.	45 lb.	30.00
No. 5 Pull Up	100 Electric Fuses	65 lb.	50 lb.	45.00

Two post only.
Two post only.
Two post only.
Two post unless specially ordered with three posts.
Three post unless specially ordered with two posts.
Two post unless specially ordered with three posts.
Three post unless specially ordered with two posts.
Two post unless specially ordered with two posts.
Three post unless specially ordered with two posts.

The maximum capacity indicates the number of electric fuses the blasting machines will fire when using two posts and two leading wires. When three posts and three leading wires are used the maximum capacity is increased 50 per cent. When iron wire fuses are used the maximum capacity of all blasting machines is only one-sixth of the capacity shown above. This does not apply to the use of iron wire electric fuses with the Du Pont Pocket Battery.

* The Du Pont Pocket is a small dry cell blasting battery for use where it is desired to fire not over three electric fuses when the cells are new.

CHARGING AND FIRING

461

Waterproof electric fuses cost about 30% more than the above. Electric fuses with iron wires cost about 15% less.

Electric fuses are packed as follows:

Length of wires.	Number of fuses in carton.	Number of cartons in case.	Total number of fuses in case.
4 ft. to 16 ft. inc.	50	10	500
18 ft. to 30 ft. inc.	25	10	250

BLASTING WIRE.

Connecting wire. No. 20 B. & S. Gauge on 1-lb. and 2-lb. spools.
 Leading wire. No. 14 B. & S. Gauge both single and duplex in 200 ft., 250 ft., 300 and 500 ft. coils.

Leading wire reels	\$4.00
Connecting wire holders	2.00

The price of wire varies with the locality, but is about as follows:

Leading wire No. 14	24ct. per lb.
Connecting wire No. 20	29ct. per lb.
Connecting wire No. 21	31ct. per lb.

This is subject to the following discounts:

Less than 50 lb., one sale, one delivery	10%
50 lb., or over, one sale, one delivery	15%
100 lb., or over, one sale, one delivery	25%

BLASTERS' THAWING KETTLES.

	No.	Capacity, lb.	Gross shipping weight, lb.	List price.
"Bradford"	1	22	25	\$4.75
"Bradford"	2	60	30	7.25
"Catasauqua"	1	30		4.75
"Catasauqua"	2	60		7.25

The price of "Bradford" is net; of "Catasauqua," 10% discount.
 F. o. b. distributing points east of Montana, Wyoming, Colorado and New Mexico.

BLASTING AUGERS.

Augers may be conveniently used to bore holes for inserting dynamite under tree stumps, etc. They cost as follows:

	Inches.	List price.
* Dirt	1½	\$1.25
* Dirt	2	1.35
* Dirt	2½	1.50
Wood	1½	1.75
Wood	2	2.25
Wood	2½	2.75
Auger handles		1.25

* Without handles.

F. o. b.: Cincinnati, O., Pittsburgh, Pa., Indianapolis, Ind.

BLASTING CAPS.

Brand	No.	Weight of charge grains or grammes.	List price * per 1,000 Lots of 1,000 or over.	Lots of less than 1,000.
Silver Medal	3	8.33 .54	\$ 6.00	\$ 6.25
Gold Medal	4	10.33 .65	6.50	6.75
Du Pont	5	12.34 .80	7.00	7.25
Du Pont	6	15.43 1.00	8.00	8.25
Du Pont	7	23.15 1.50	10.00	10.25
Du Pont	8	30.86 2.00	13.25	13.50

* The discount from above is about as follows:

In lots less than 20,000 at factory, net.

In lots of 20,000 or over delivered, 10%.

Caps are packed in the following size cases without extra charge.

Case 0	500 caps to the case.
Case 1	1,000 caps to the case.
Case 2	2,000 caps to the case.
Case 3	3,000 caps to the case.
Case 5	5,000 caps to the case.

BLASTING FUSE.

The price list of fuse given below is subject to about the following discounts:

In lots of less than 1,000 ft.	2 ½ to 10%
In lots of 1,000 to 5,000 ft.	7 ½ to 15%
In lots of 6,000 ft. and over	17 ½ to 25%

Depending on the section of the United States where it is sold.

Kind of fuse and use.	Price per 1,000 ft.	Packed in	
		barrels, ft.	cases, ft.
Hemp, for use in dry ground	\$3.05	12,000	12,000
Cotton, for use in dry ground	3.55	12,000	12,000
Superior Mining, for hard tamping	3.75	8,000	6,000
Beaver Brand, for use in wet ground	3.90	8,000	6,000
Single Tape, for use in wet ground	4.05	8,000	6,000
Anchor Brand, White Finish, for use in very wet ground	4.65	8,000	6,000
Crescent Brand, White Finish, for use in very wet ground	4.65	8,000	6,000
Reliable Gutta Percha, for use in very wet ground ..	4.65	8,000	6,000
Double Tape, for use in very wet ground	4.85	8,000	6,000
Stag Brand, White Finish Gutta Percha, for use in very wet ground	5.60	8,000	6,000
Special No. XX, Gutta Percha, semi-smokeless and almost free from lateral emission of sparks	5.60	8,000	6,000
Triple Tape, for use in very wet ground and will bear rough treatment	5.70	7,000	6,000
Special No. XXX, Gutta Percha, designed to be even freer from smoke and sparks than Special No. XX	6.70	8,000	6,000

The packages weigh approximately:

	Barrels, lb.	Cases, lb.
Hemp and cotton	135	135
Triple Tape	150	125
All others	145	115

CHAPTER XI

METHODS OF BLASTING

The Theory of Blasting. The rules commonly found in text books are based upon theories which in turn are founded upon assumptions as to conditions not often encountered in practice. One may safely look with suspicion upon any dogmatic rule as the amount of explosive to use and the spacing of blasting holes. In the first place most of the "rules for blasting" were originated by users of black powder, and are valueless when applied to high power explosives. In the second place, many of the rules apply only to single shots, and not to the simultaneous firing of many holes by electricity. In the third place, practically all of the rules ignore the use to which the blasted rock is to be put. Hence "rules for blasting," no matter how high the authority back of them, are apt to be exceedingly misleading.

Rock that is quarried for dimension stone masonry requires close spacing of blast holes on a straight line, but these rows of holes themselves may be several feet apart. When holes are drilled close together in this way and fired simultaneously, using very small charges of black powder in each hole, a huge block of solid rock may be wedged off without shattering it.

Rock that is quarried for concrete, ballast or macadam purposes should be well shattered to save the cost of sledging and "blockholing" into sizes that will enter the crusher. This means an entirely different spacing of the holes from dimension stone quarrying, and it usually means the use of a high power explosive that will thoroughly shatter the rock.

In the two cases just cited the rock is put to some use after it is quarried; but in open-cut work on canals and railways the rock is frequently wasted, and is broken up only to as small sizes as can be handled conveniently by the appliances available. In some cases these appliances are simply crowbars, for levers, and boards, for inclined planes, up which the stone may be rolled by hand into wagons. In other cases derricks that can lift only a ton or so are available; while in still other cases cableways that can handle a mass of ten tons are to be used; or it may happen that steam shovels are to load

the stone, in which case it must be shattered to comparatively small sizes.

With all these variable factors, how absurd it is to lay down any inflexible "rules for blasting," and yet we find such rules in every text book. Often, it is true, the author forewarns us that judgment must be used in applying the rules, but neglects to tell us afterward where and how to acquire that judgment. Indeed, by the very act of omitting to say anything further as to the exercise of judgment, the author permits us to forget that he has told us that the rules must be used with judgment.

The Crater Theory. Regarding the theory of blasting, much more has been put into print than is warranted by the meagre scientific experiments made by the writers. A commonly quoted theory of the action of an explosive is one that may be termed "the crater theory." According to this theory an explosive buried in a mass of earth or rock will blow out a funnel-shaped crater whose sides are supposed to have a slope of 1 to 1, if the surface of the earth or rock is horizontal, as shown in Fig. 96. The distance D B; or, to be more exact, the distance D F from the surface of the rock or earth to the center of the charge of powder, E B, is called the "line of least resistance." The volume of the funnel or crater is:

$$V = \frac{1}{3}l \times \pi l^2 = l^3 \text{ (nearly)}$$

Hence the general formula for the volume of rock loosened by one charge so as to form a funnel crater is:

$$V = m l^3$$

According to Schoen, $m = 0.4$ for tough, soft rock.

$m = 0.9$ for hard, brittle rock.

This means that in tough soft rock the sides of the crater are steeper than 1 to 1, but in hard, brittle rock they are nearly 1 to 1.

Note carefully that this theory assumes two things: first, that only one charge of explosive is fired at a time; second, that the rock is homogeneous and has no seams or cracks. Except for chamber blasting, this theory, in my opinion, is not worth the ink it is printed with; because, in practice, shots are not fired singly nor is the rock ordinarily free from seams and joints.

If the drill holes were bored vertically in rock, as in Fig. 96, and heavily charged with black powder, it might blow out the tamping and fail to rupture the rock at all. The writers who *have accepted* the "crater theory" have, therefore, reasoned that *drill holes* should be drilled at an angle with the surface, along *some such line* as A B, instead of along the line of least resist-

ance, D B, as shown in Fig. 96. If this were done the length of the line of "least resistance," D B, would be about 0.7, or nearly $\frac{3}{4}$ the length of the drill hole A B. Hence we find the rule laid down with the utmost dogmatism, that "the line of least resistance should never be more than three-quarters the

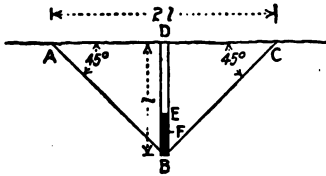

Fig. 96. The Crater.

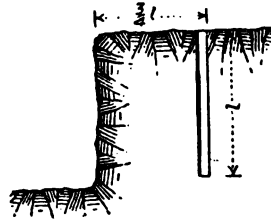

Fig. 97-A. A Bench.

length of the drill hole." Then they go a step further and show us a drill hole in a bench, as in Fig. 97A, placed back from the face so that the distance from the face is three-quarters the depth of the hole, and they tell us that this ratio should never be exceeded. With single shots, with black powder, with a rock perfectly homogeneous, we may concede that there is some reason in this rule, but as it is given in text books without any qualifications or explanations at all, the rule is worthless. With dynamite I have often placed a row of holes a distance back from the face just twice as much as this rule permits; and the result has been excellent when the rock was much seamed and easily broken by holes fired simultaneously.

The advocates of the crater theory of blasting recommend that the "rock coefficient" be obtained for any given kind of rock as follows: Drill a row of holes 2 ft. back from the vertical face of rock to be blasted down in benches. Let these vertical holes be 6 ft. apart and 3 ft. deep. Charge one hole with a very small charge of explosive; charge the next hole with a greater charge; and so on, charging each hole heavier than the last. Tamp and fire the holes separately, and select that hole which has given the best results — the one that has broken rock without hurling it far. Suppose this particular hole was charged with 0.5 lb. of dynamite, then the "rock coefficient" is:

$$\frac{0.5}{2^3} = \frac{0.5}{8} = 0.06$$

The rule is:

Divide the charge of the explosive in pounds by the cube of the line of least resistance in feet to get the "rock coefficient."

Then, they tell us, we have only to multiply this "rock co-

efficient" by the cube of the line of least resistance that we intend to use in practice, to ascertain the proper charge for each hole. Thus, if we are going to drill holes so that the line of least resistance will be 8 ft., we multiply 0.06 by 8³, or 0.06 x 8 x 8 x 8, and we get 30.72 lb. as the proper charge per hole. I have tested this rule, and I have found that it gives too large a charge for deep holes in stratified rock with a long line of least resistance.

Wherein is the "crater theory" defective? To begin with it assumes that the work the powder has to do is entirely dependent upon the volume, or weight, of rock to be moved; that if 0.8 lb. of powder will break 1 cu. yd. of rock in a shallow hole, the same proportion of powder will break the rock in precisely the same manner in a deep hole, requiring always the same fraction of a pound of powder per cubic yard, whether the holes are deep or shallow. Every experienced blaster knows that this is not so. Generally the deeper the holes (and consequently the longer the line of least resistance) the less the number of pounds of powder required per cubic yard.

When we consider the work that an explosive has to do, we find no good reason for assuming that equal weights of powder will break equal weights of rock regardless of depth of holes. The force of the powder is mainly expended in four ways: (1) shearing the rock loose; (2) in overcoming the inertia of the rock mass; (3) in heating the rock; and (4) in imparting motion to the surrounding air. If all the work were expended in shearing the rock, then since the volume of a crater varies as the cube of the line of least resistance, while the area of the slopes of the crater varies as the square of the line of least resistance, it is evident that the shorter the line of least resistance the greater the unit work done by the powder in shearing loose the rock. Thus a crater 2 ft. deep, having an apex angle of 90°, has an area of side slopes of 17.78 sq. ft. and a volume of 8.4 cu. yd., or 2.1 sq. ft. per cu. ft. A crater 8 ft. deep has an area of 284 sq. ft. and a volume of 536 cu. ft., or 0.63 sq. ft. per cu. ft. Hence the work of shearing off the rock in the 8-ft. crater is about one-fourth as much per cu. yd. as the corresponding work in the 2-ft. crater. In a well-charged blast, where the rock is merely shattered, but not heaved, the work of overcoming the inertia of the rock is comparatively slight; but we do not know, and can at present not even guess, what portion of the energy of the powder is entirely lost in heating the rock and in imparting motion to the air. For all that can now be proved to the contrary, we might assume that *this percentage* of lost work is a constant percentage in large and in small blasts.

Placing Drill Holes. In the days of black powder it was essential to consider carefully the position of seams and bedding planes in the rock so as to place the drill hole where the powder would have the least possible work to perform in shearing off the rock. Upon the introduction of dynamite it was found that less care need be taken in placing the drill holes with regard to natural seams in the rock, excepting in quarrying dimension stone. Nevertheless, some attention should always be given to the position of planes of weakness, especially in stratified rock. In open-cut work, where the rock is excavated in benches, it is well to have the bottom of the drill hole stop just short of a plane of stratification or weakness in the rock, even if to do so necessitates drilling holes somewhat shallower than they would be drilled in rock uniformly solid. In tunneling and shaft sinking, where hand drills are used, care is always taken to locate the "cut holes" with reference to seams or planes of weakness in the rock. If the strata in a hand-driven tunnel dip downward toward the face, drill and fire the first holes near the roof; if the strata dip down away from the face, drill and fire the first holes near the floor. In any case drill a hand-driven hole as nearly perpendicular as possible to the planes of weakness in the rock. The spacing of holes will be given in subsequent chapters, but reference should be made to Tables LVII and LVIII, pages 497 and 498.

Methods of Placing Holes for Blasting. (From an article by P. B. McDonald, mining engineer, Iron River, Mich., published in the *Engineering and Mining Journal*.) Wrong judgment in placing drill holes is one of the most expensive mistakes in underground work; expensive because of the loss of explosives and time in the costly operation of reblasting. The following incident is of common occurrence: A miner drills a cut of say, 12 holes and blasts them. If the ground is tough, the misplacing of one hole upon the breaking of which the effects of several others depend, may spoil the blast so that large ridges or corners are left. He then cleans or blows out the holes which failed to break and uses from 10 to 40 sticks of dynamite, costing 10 ct. per stick, for blasting the same holes a second time. In almost every such instance one or two extra holes or a closer attention to the position of the holes drilled, would have made the difference necessary to produce a successful blast in the first trial. The time spent on reblasting is usually more than would have been required for the added care in placing the holes, and the greater powder cost and the time consumed waiting for the smoke to clear, are distinct losses. The nature of rock excavation is such that a 5% closer attention to details may mean a 25% gain in results.

The simplest form of blasting is slicing or breaking to an open face. In open-cut excavation, holes are drilled at a distance back from the face a little less than the depth of the hole, although this distance is shortened in tough igneous rock and where the blasted portion is held at the ends as in drawing back a narrow stop. A favorite arrangement of holes for use on bench work in open-cuts is shown in Fig. 97B. The horizontal holes are fired at the same time as the vertical holes, in this manner deepening the cut broken.

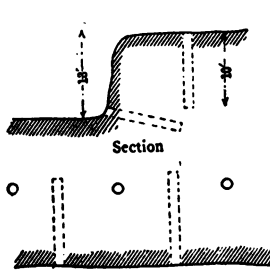

Fig. 97-B.

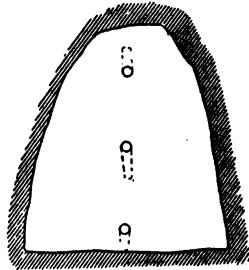

Fig. 97-C.

In drifting in soft rock, such as friable schist or crumbly slate, most of the standard arrangements of holes give good results and the misplacing of one or two does not usually matter. The arrangement shown in Fig. 97C is, of course, applicable only to soft rock where the blasting shatters the rock so thoroughly that it can be picked out. Fig. 97D shows a 10-hole cut with one back hole, frequently used in driving small drifts where it is desired to keep the back well arched. The arrangement shown in Fig. 97E is suited to larger square drifts. These holes would not break much hard rock because of the distance between the bottoms of the cutting-in and squaring-up holes.

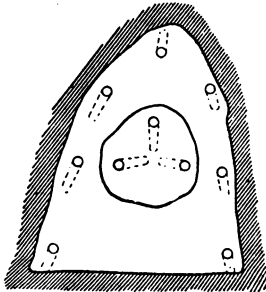

Fig. 97-D.

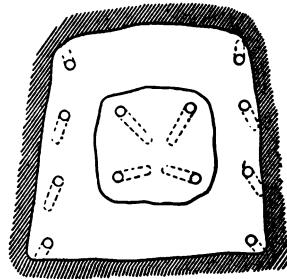

Fig. 97-E.

It will be noted that Figs. 97D and 97E, depicting standard cuts in soft rock, show two classes of holes, the cutting-in holes, and the squaring-up holes which determine the shape of the drift. In hard rock there are, in addition, what are conveniently called relief holes, because, situated and fired intermediately between the cutting-in and the squaring-up holes, they relieve the ground to be broken by the latter set. It is in the drilling of such a cut that the best judgment is required, for relief holes are a changeable feature and slight variations in the toughness of the ground and the size of the workings necessitate differently placed relief holes for successive cuts.

The most important rule to be observed in placing holes is that the determining factor is not the distance apart of the starting points of the holes but the distance between their bottoms. The upper few feet break out into the drifts comparatively easily, but the inner portion breaks with more difficulty. For instance, in Fig. 97E the tops of the holes are $2\frac{1}{2}$ ft. apart, while between the bottom of the cutting-in and the bottom of the squaring-up holes is 4 ft. of rock, so that in hard ground the cut would not break. Experience in any variety of rock will show what unit may be figured upon for the dividing distance of the bottom of the hole, usually 2 or $2\frac{1}{2}$ ft. The distance from the cutting-in to the relief holes is made less than from the relief to the squaring-up holes (figuring between bottoms in each case); possibly the former is 2 ft. and the latter $2\frac{1}{2}$, because obviously the squaring-up holes have a better chance to break out in the space enlarged by the relief holes than the relief holes have in the confined space made by the cutting-in holes.

In planning the arrangement of holes the first consideration is to get a cutting-in hole that will break well. The smaller number of holes used for this, the better, because it is essential that cutting-in holes be fired simultaneously, and owing to irregularities in the rate of burning of fuse, this is difficult to accomplish when a large number of holes are to be fired; also, starting a cutting-in hole is often difficult because of the angle at which the drill point has to meet the face. The excavation made by three holes meeting at a point is almost as large as by five or six, so that it is usually better to use only three or four holes for cutting-in; and, if the ground requires them, to put the extra holes in as relief holes where they will break more ground.

After deciding upon the cutting-in, the squaring-up holes are placed along the sides, bottom and top, with the ground equally divided between their bottoms. Perhaps two relief holes, one on each side of the cutting-in holes, will suffice; Fig. 97F shows

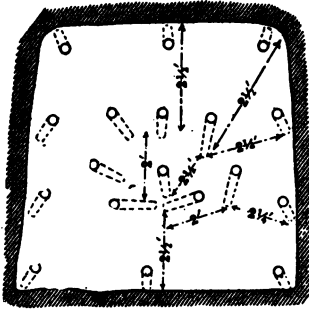

Fig. 97-F.

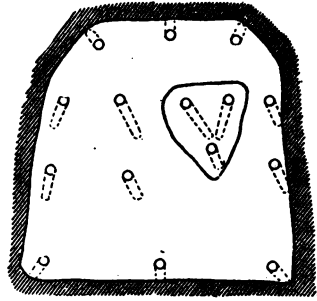

Fig. 97-G.

two on either side and one above, helping the middle back hole, which is important because upon its breaking depends the successful blasting of the other two back holes. In the sketch the cutting-in holes are placed low; they might have been shifted higher and the upper relief holes placed underneath. Quite a common alternative is to shift the cutting-in holes to right or left, so that relief holes are required on but one side; thus in Fig. 97G it is seen that the cutting-in holes are to the right and high.

To sit in the office and figure the arrangement of holes for a cut is not satisfactory, unless the sketch is drawn to scale, because it is easy to draw the holes out of proportion without regard for practical considerations. The holes cannot be pointed at such an angle as is sometimes desirable because the crank end of the machine will strike the sides or back of the drift. It is generally good practice to drill as few dry holes (those which will not hold water) as possible, and this throws out many of the cuts drawn by men who never helped drill a sticky hack-hole; also it should be aimed to economize on movements of the arm and bar.

An inexperienced man examining the holes for a cut is apt to think that the deviation of the holes is at too small an angle, and that the holes are too straight. It is not an easy matter to tell definitely where the bottom of the holes will come, but for judging two relatively, the following method is frequently employed by mine foremen in checking a miner's holes. When one is finished a long drill or tamping rod can be inserted in the hole so that the end protrudes several feet, and the amount by which it approaches or diverges in 2 ft. from a new hole being started, can be measured, from which the relative location of their bottoms can be gaged.

The structure of the rock plays an important part in the placing of holes for blasting. The presence of joints, fissures, faults or slips, and the texture of the rock affect the number of holes that are necessary and their position. A miner who is accustomed to drilling jointed sedimentary rocks is liable to underestimate the number of holes necessary for a tough igneous rock; contractors bidding on tunnel-driving contracts give this matter considerable attention. Again a miner who has been drilling igneous rock will be surprised that some of his holes in a sedimentary formation break so well, but that others do not break at all. Most miners know that in drilling a drift in sedimentary rock at right angles to the bedding plane, the ground breaks out much better than in drifting parallel to the formation, while in open-cut work slabs lying along the bedding plane can be broken off easily.

Springing Holes. In order to enlarge a drill hole so that a greater charge of powder may be placed in the hole, a few sticks of dynamite may be exploded at the bottom of the hole so as to make a chamber there. This process is variously termed "chambering," "springing," "shaking," "bullying," etc. In earth and soft rocks like shale, the dynamite used in springing the hole compresses the material at the bottom of the hole and thus enlarges the hole; in hard rock the dynamite pulverizes some of the rock and hurls the powdered rock out into the air, leaving a chamber. In very soft material the first springing will make a sufficiently large chamber; but in hard rock repeated springing, with increasingly large charges of dynamite, becomes necessary. Thus in springing 20-ft. holes in sandstone I have used for the first springing shot 2 sticks of 40% dynamite; for the second springing shot, 5 sticks; for the third shot, 20 sticks. The chamber thus made was charged with 8 kegs, or 200 lb. of black powder.

Springing can be used with great economy of explosives in open-cut work where deep holes can be thus enlarged and charged with black powder or Judson powder. It is indeed surprising to note how often holes are charged with dynamite and fired without any attempt to test the springing method of blasting. On the other hand, I have frequently seen the springing method used under conditions not at all favorable; thus in 6-ft. holes in hard limestone, where a sewer trench was being excavated, the contractor was firing in successive shots a total of 8 or 10 sticks of dynamite for the sake of crowding a few more sticks into the bottom of the hole for the final shot. A much more economic arrangement of powder in sewer trenches is to distribute it in small, separate charges from the bottom to near the top of hole, and not to concentrate it at the bottom.

In tunneling, on the other hand, it is always desirable to concentrate as much of the charge as possible at the bottom of the hole; and, were it not for the fumes and dust produced by springing, it would always be good practice in railway tunneling through comparatively soft rock to spring the holes. With water for spraying the air after each shot the objection to springing the holes would disappear. In stoping, shaft sinking and tunneling there is every reason for concentrating the charge as much as possible at the bottom of the hole, and no pains should be spared in experimenting with the springing method of blasting, even to the installation of a water supply system for clearing the air of dust and fumes after each springing shot. In open-cut work it is not so essential to have the charge in the bottom of the hole if dynamite is used; but if black powder or Judson powder is to be used a sufficient quantity cannot be charged in the hole of ordinary diameter unless the holes are placed close together. The use of the springing method enables the blaster to place the holes far apart in stratified rocks (and thus reduce the cost of drilling), and to load them with large charges of low-grade powder, thus reducing both the cost of drilling and of explosive.

In springing a deep hole it is customary to tamp the springing shot with a small quantity of sand, no attempt being made to fill the hole with tamping. In shallow holes in mines and tunnels less than a stick of 75% dynamite well packed, may be used for the first springing shot. Lower or shove into the hole a small "primer" containing the cap; tamp with fine sand, and fire.

After the hole has been sprung, if it is to be loaded with black powder, care should be taken not to put the powder in before the rock has cooled off. It sometimes happens that the chamber made by springing is not large enough to hold the necessary charge of powder; in such cases there is an advantage where Judson powder has been used, for the Judson powder may be ignited and burned up without exploding, thus making it possible to enlarge the hole by further springing. Where the rock strata are inclined at a high angle it sometimes happens that the shock of springing will cause a slip, closing up the chamber and causing a loss of the hole. In very soft shales a heavy springing shot will fill the chamber with debris.

Blasting with Powder and Dynamite Together. In blasting blue sandstone on the Wabash Railroad in eastern Ohio, Mr. W. M. Douglass, of Douglass Bros., has found that the most effective way of blasting so as to reduce the stone to small sizes easily handled by a steam shovel is to fire large charges of black powder and dynamite in alternate rows of holes.* Figs.

* See page 268 for the cost of drilling in this sandstone.

98A and 98B show two typical blasts, Fig. 98A. being the last blast fired when there were two faces. The holes were all drilled 24 ft. deep with a well driller, the bit being 3 in. in

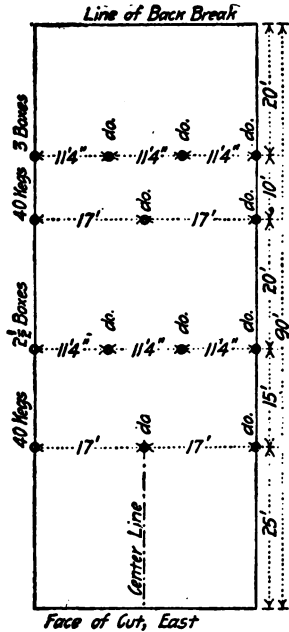

Fig. 98-A.

Blasting with Powder and Dynamite.

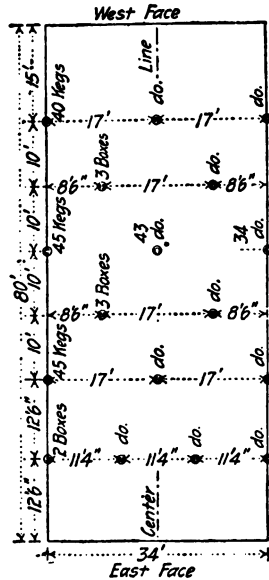

Fig. 98-B.

diameter at the bottom of the hole. The holes marked "kegs" were loaded with the number of 25-lb. kegs of black powder given in the diagrams, after springing with dynamite. In springing each hole in Fig. 98B 15 sticks ($1\frac{1}{4} \times 8\frac{1}{4}$ in. size) were first fired, then 40 sticks, then 80 sticks and finally 130 sticks, a total of 265 sticks, or about 132 lb. of 40% dynamite per hole for springing. The holes marked "boxes" were loaded straight (without springing) to within 4 ft. of the top, each hole containing as many 50-lb. boxes of 40% as indicated by the figures in the diagrams. In making a blast the dynamite and black powder were fired together, the theory being that the black powder would lift the rock, while the dynamite would shatter it. The results were excellent. The blast shown in Fig. 98A broke the rock up for 20 ft. back of the last row of holes; and, in making this blast, about 800 lb. of dynamite were used in springing

the six holes, beside the 1,100 lb. of dynamite used in the blast itself; 6,000 lb. of black powder were also used in this blast. The amount of rock within the boundary lines of the outer holes, to a depth of 24 ft., was about 2,100 cu. yd.; and it was 2,700 cu. yd. within the boundary lines of the diagram back to the "line of back break." For the blast shown in Fig. 98B there were used 1,600 lb. of dynamite in springing the holes, 1,000 lb. of dynamite in the blast and 9,425 lb. of black powder in the blast. The amount of rock within the boundary lines of the diagram (to depth of 24 ft.), was more than 2,400 cu. yd. The rock was excavated for 2 or 3 ft. outside the boundary lines.

Chamber Blasts. We have seen how by springing a drill hole a small chamber can be made so as to receive a comparatively large charge of explosive, and thus reduce the number of feet of drill hole per cubic yard of rock thrown down. This method may be carried out on a much larger scale by driving a small tunnel (if very small it is called a "gopher hole" or "coyote hole") or sinking a shaft at the end of which chambers are prepared to receive a great charge of explosive. In this way a mountain of rock may be broken down at one shot, with a great saving in labor and powder. This method of chamber blasting is particularly economic in breaking down banks of hardpan for removal either by steam shovels or by hydraulicking. Unfortunately there is not a great deal in print relative to chamber blasting. Writers without exception fail to state how much "block holing" is necessary to reduce the chamber-blasted rock to sizes that can be handled by derricks or that will pass through crushers.

The following abstracts of articles on chamber blasting contain valuable information:

Chamber Blasting for Rock-Fill Dams. In *Engineering News*, May 17, 1900, "W. M." describes "the second largest blast in the history of high explosives," fired Dec. 18, 1899, at West Beaver Creek, Col., by the Pike's Peak Power Co., for the building of a rock-fill dam requiring 42,000 cu. yd. of rock. A granite "butte" or cone of rock was selected and a tunnel run into it 75 ft. below its apex. The tunnel was 135 ft. long, and had several bends in it, Fig. 99, so as to render blowing out of the charge impossible. Cross drifts were run 35 ft. each way from the end of the tunnel. In these cross drifts were charged 32,000 lb. of black powder and 144 lb. of dynamite, distributed as shown, and packed solid with bulkheads, b. of sacks of powder. The remaining part of the T was filled with rock and earth, except along one wall where 3,000 lb. of powder were placed in bags. E. Firing holes, d, 36 in number and 5 ft. deep, contain-

ing 4 lb. of dynamite each, with 3 electric exploders each, were connected in series, making three circuits, so that in case one circuit was found to be open another would be available. The main tunnel was tamped solid with rock and earth, timber bulkheads being placed at c. The firing station was 3,000 ft. away. The explosion opened a crater 72 ft. deep and 150 ft. wide, breaking 110,000 cu. yd. of rock, or 80% of the rock above the tunnel level. A tunnel through the rim of the crater gave access to the broken rock. Mr. R. M. Jones was the engineer of the company.

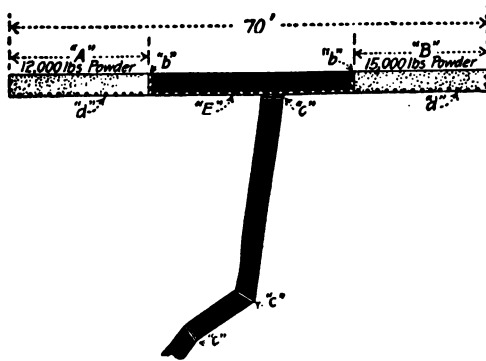

Fig. 99. Tunnel Blast at West Beaver Creek, Col.

Mr. W. R. Russel is authority for the following data on chamber blasting for a rock-fill dam at Otay, Cal.: The rock was a porphyry, easily broken, but very hard to drill. Quarrying was begun by drilling holes by hand 12 to 20 ft. deep, but this was found to be too slow and expensive, so it was decided to run a tunnel and make one large blast. This was done by driving a 4 x 5½-ft. drift 50 ft. and then branching so as to form a Y. The drift was large enough so that double-hand drilling could be used. The ends of the Y were enlarged to form powder chambers. The chamber on the right held 4,000 lb. of Judson powder; the one on the left held 8,000 lb. A 50-lb. box of dynamite was placed in each chamber. The drift was completely packed with earth and sand. This blast threw down about 50,000 cu. yd. of rock, at a cost of 3.6 ct. per cu. yd. The cost was:

86-ft. drift	\$ 645
12,000 lb. Judson powder	960
Charging	75
Total	<u>\$1,680</u>

Part of these 50,000 cu. yd. was further broken up by firing powder in the seams, making a total cost of 5 ct. per cu. yd.

For the second blast a shaft was sunk to a depth of 115 ft. and about 85 ft. back from the quarry face. At a depth of 50 ft. two drifts were run in opposite directions for 25 ft., and a powder chamber was made at each end. At the bottom of the shaft two more drifts were run, one 35 ft., the other 30 ft. The total charge was 15 tons of powder, the greater part being in the bottom chambers. This blast was also very satisfactory. In both cases the electric wires were laid in 1-in. pipes, which were covered by the sand tamping, and the tamping was moistened to make it more effective. After these large blasts there was never any stopping of work to fire, for the larger rocks were block holed and blasted at noon and at night. A derrick delivered the rock to a Lidgerwood cableway of 955 ft. span, capable of handling a 10-ton load. As high as 250 skip loads were handled in 10 hr., the daily average being 200 loads. The time consumed in hoisting and lowering a skip was 20% of the time required to make the trip from the quarry to the dam.

Mr. M. M. O'Shaughnessy gives a description* and the cost of a 180,000-ton chamber blast in solid granite for the construction of the Morena rock fill dam at San Diego, California. The desire was to blast much of the rock from its original position in a cliff to its final site in the dam beneath, and to convey the remainder into place by cableways. The following method was pursued:

North of the spillway an open cut 100 ft. long and about 40 ft. deep was made at the toe of an old quarry (See Fig. 100). Parallel to this and 100 ft. distant, a 4 x 5-ft. tunnel, 115 ft. long and 10 ft. above the level of the open cut, was driven into the solid granite. Seventy feet from the portal a small chamber depressed below the bottom of the tunnel was excavated and enlarged to contain 3.25 tons of powder. At the end of the tunnel a channel large enough to contain 16.2 tons of powder, was excavated. The grade between the tunnel and open cut conformed to the natural dip of the rock. In the larger chamber there were 571 boxes (50-lb.) of 7 and 9% Champion powder, 38 boxes of No. 2, 40% dynamite weighing 1,900 lb., and 40 boxes of No. 1, 60% dynamite, in all 16.225 tons. In the smaller chamber there were 100 boxes of 7% Champion powder, weighing 5,000 lb., and 30 boxes of No. 2, 40% dynamite, weighing 1,500 lb., in all 3.25 tons.

In large blasts where powder forms the bulk of the charge, it

* *Transactions American Society of Civil Engineers*, Vol. 75, p. 27, abstracted in *Engineering and Contracting*, Jan. 19, 1910.

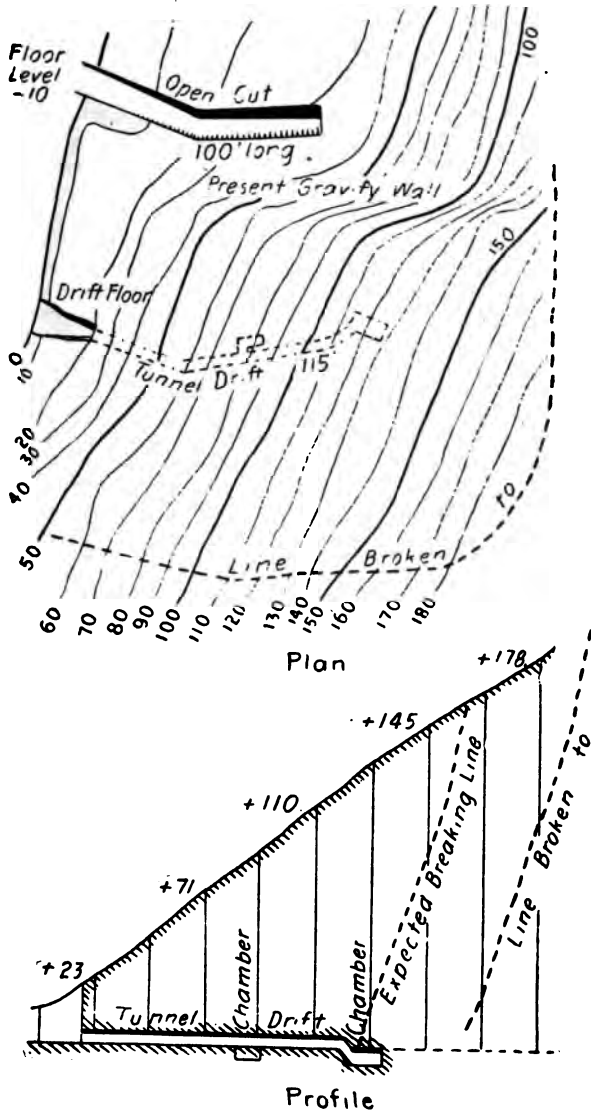

Fig. 100. Plan and Profile of Large Blast.

is preferable to sink pits below the tunnel floor level on account of the greater facility with which a loose powder is loaded into a pit and because greater compactness of the charge is obtained by the constant treading of the men. In addition the sides of the pit offer greater resistance, which is of the utmost importance as this determines in great measure the quality and quantity of the charge. The large charge of dynamite for primers was used, first, to obtain instantaneous maximum pressures, and, second, for the percussive action.

The large tunnel pit was first loaded with 10,000 lb. of powder, then 2,000 lb. of 60% dynamite in a circle 2 boxes high against the west wall, and then 1,900 lb. of 40% dynamite similarly placed against the east wall. The percussive action of these primers was such as to start a break or shear about 2 ft. below the tunnel floor in a parallel plane, allowing the more slowly forming powder gases to expand horizontally, thus preventing a crater or blow-out. The remainder of the charge was placed on top. The charge in the smaller pit was distributed in a similar manner. The tamping was of fine earth with bulkheads of rock at intervals of 10 ft. throughout the tunnel, and a heavy timber bulkhead at the drift portal.

The cost of the blast was as follows:

Tunnel and loading	\$2,478
Open cut	3,500
Powder in chambers	3,116
	Total
	\$9,094

The greater part of the rock was broken into blocks of from 50 lb. to $\frac{1}{4}$ ton in weight, enabling the cables to move rock very effectively. From the above cost should be deducted 1,400 cu. yd. of solid rock excavated from cut and tunnel, worth \$1,400 which left a net cost of \$7,694 or 4.3 ct. per ton for 180,000 tons.

A blast which loosened 10,000 cu. yd. of rock for the construction of a dam was set off in Colorado in 1911 (*Engineering and Contracting*, May 17, 1911). A "one man" tunnel was excavated for a distance of 40 ft. into the face and just above the base of the cliff. At the end of the drift a cross cut was excavated to the right and another to the left for a distance of 12 ft. At the ends of these, pits were excavated 4 x 4 x 4 ft. below the tunnel floor. These pits received the explosive, consisting of 7,500 lb. of R.R.P. powder and 500 lb. of 40% dynamite. The charges were connected to an electric battery about 300 ft. distant. The tunnel was backfilled with earth well packed in. The cost was 17 ct. per cu. yd. distributed as follows:

Labor	\$ 384
Dynamite	155
Powder	1,140
Caps and fuse	10
Total	<u>\$1,689</u>

Chamber Blasting in Quarries. Mr. Ellis Clark, Jr. (*Transactions, American Institute Mining Engineers*, Vol. 7, p. 206) gives a description of a large blast in limestone quarry in Northampton Co., Pa. The rock was Auroral limestone and varied considerably, containing in parts slate and flint. The quarry face was 130 to 140 ft. high. A tunnel 237 ft. long by about 3 ft. wide was driven at an elevation of 15 ft. above the quarry floor, and from 50 to 100 ft. from the face along the line of a fault. The digging was fairly easy. Four powder chambers about 45 ft. apart and 50 ft. from the face were laid out. No. 1 cross-cut tunnel was driven about 56 ft. from the mouth of the tunnel at right angles to it. This was in very hard rock. No. 2 cross-cut was mostly through a soft earthy stratum. The shaft was through fire rock. No. 4 shaft was at the end of the main tunnel and was very wet. After charging with black powder and tamping, the chambers were shot by electric batteries situated 400 ft. from the blast. Labor was paid \$1.10 per day, but much of the tunnel was done by contract with miners. The cost was as follows:

Main tunnel along seam in rock, 237.5 ft.	\$ 262.05
No. 1 cross-cut tunnel, 40.5 ft.	184.48
No. 1 shaft 18 ft. deep	120.17
No. 1 powder chamber, 5.25x5.25x6 ft.	49.16
No. 5 shaft, 24 ft. deep	132.95
No. 4 powder chamber, 5x5x6 ft.	62.31
No. 2 cross-cut tunnel, 25.5 ft.	156.31
No. 2 shaft 19.5 ft.	139.64
No. 2 powder chamber, 5.25x5.25x6 ft.	35.88
No. 3 cross-cut tunnel, 10 ft.	50.15
No. 3 shaft, 21.25 ft. deep	135.84
No. 3 powder chamber 5.25x5.25x6 ft.	56.11
Drilling absorbing well in No. 4 shaft, 14 ft.	16.50
General mining expenses, ventilation, fan, travelling expenses, etc. .	122.73
Powder (12,000 lb.) and tamping account	2,053.88
Electrical account	288.68
Relaying track	17.90

Total cost of blast (including tools and batteries, etc.) \$3,884.64

A large blast in a sandstone quarry of the Hercules Sandstone Co., Ferrino, Wash., is described in *Engineering and Contracting*, May 8, 1912, and is shown in plan in Fig. 101. The quarry of sandstone had a 65-ft. face. The tunnels and cross-cuts were 3½ x 4 ft. in section. Tunnel No. 1 was entirely in the bedding plane of slate; tunnel No. 2 was in sandstone after the first 50 ft. The presence of the slate at No. 1 accounted for the more complete disturbance of the rock at that side.

The total powder charges were 1,724 kegs or 43,100 lb. of

black blasting powder and 1,250 lb. of 60% dynamite. The black powder was left in the original packages, the bung hole of every fifth keg being left open. In the center of each charge of powder was placed a primer charge of dynamite to 50 lb. of powder. The tamping was solid "muck" to the mouth of the tunnels, and was reinforced by wedged timber ties where shown

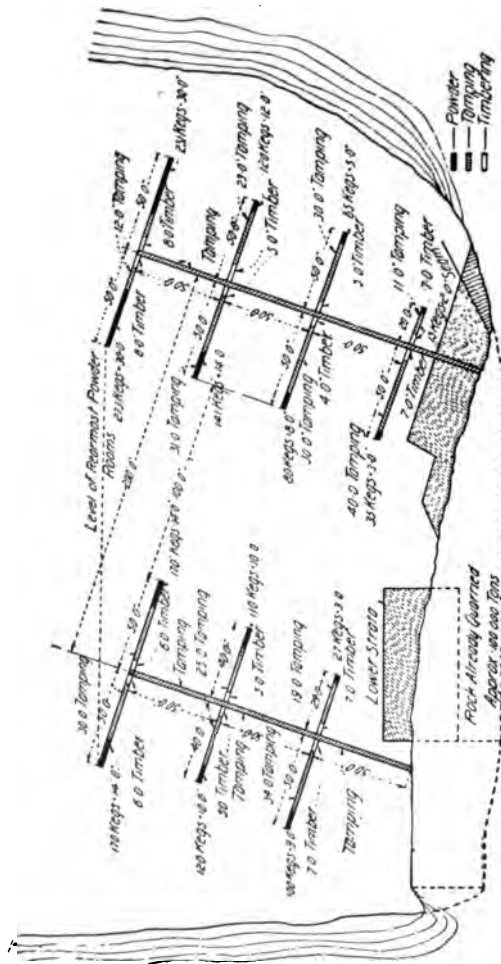

Fig. 101. Plan of Tunnels and Loading for Quarry Blast.

in the plan. The mouths of the tunnels were closed with Portland cement bulkheads. No. 6 "Victor" electric exploders were used, 28 exploders being placed to a charge.

Estimating 220,000 cu. yd. as the amount of rock displaced, and figuring the rock as weighing 160 lb. per cu. ft., the tonnage amounted to 475,200 tons. One pound of powder displaced 11 tons or 4.1 cu. yd. of rock, or about $\frac{1}{4}$ lb. of powder was required per cu. yd. of rock.

The following data are from *Engineering and Contracting*, July 24, 1912. In May, 1912, a large blast was made in a quarry at Pedro, California. Fig. 102 shows the plan of the tunnels, which were driven at the floor level. At the end of each cross-cut a sump or pit about 6 ft. was excavated.

The overburden at the breast of each tunnel was:

	Ft.
No. 1	70
No. 2	85
No. 3	93
No. 4	98
No. 5	104
No. 6	100

This was an average overburden of 91 ft., over the black powder charges, and an average overburden of 68 ft. for the entire area.

The charge, estimated to produce a maximum amount of fine material, and at the same time waste no material into the King's River, was 114,000 lb. of Judson R. R. P., and 11,400 lb. of Hercules 60% dynamite, a total of 125,400 lb. of explosives. This charge was distributed in the cross cuts as follows:

Location.	Lb. Hercules 60% N. G.	Lb. Judson R. R. P.
A600	6,000
B650	6,500
C250	2,500
D250	2,500
E700	7,000
F700	7,000
G250	2,500
H250	2,500
I700	7,000
J700	7,000
K250	2,500
L250	2,500
M700	7,000
N700	7,000
O250	2,500
P250	2,500
Q700	7,000
R700	7,000
S250	2,500
T250	2,500
U700	7,000
V800	8,000
W250	2,500
X300	3,000

Tunnel 1 had the least overburden and it was undesirable to obtain very much overbreak to the left, because a quantity of rock at this side was too hard for the crusher to handle, and it was desired to leave this rock in place to be blasted out later and wasted on the dump. The blast swept around this rock leaving it practically undisturbed. Tunnel 6 had a very heavy overburden, and maximum overbreak was desired, so the two

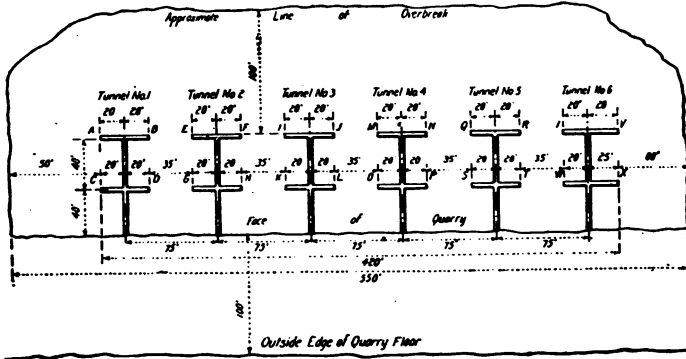

Fig. 102. Plan of Location of Tunnels for a Large Blast.

cross cuts driven to the right from this tunnel were made 5 ft. longer and they were loaded heavier than the others.

The Hercules dynamite was not removed from the cases, but all Judson R. R. P. was removed and taken into the tunnel in the original bags, 200 lb. at a time. This was stowed snugly in the pits at the ends of the cross cuts, being tamped down by tramping on the charge.

Tunnels 2, 3 and 4 were wet, considerable water dripping from the walls. All the pits in these tunnels were filled to a depth of 18 in. with large rock and the chamber was entirely lined with many thicknesses of paraffine paper from the Judson R. R. P. cases to keep the powder dry. It was calculated by actual observation and measurement that the water seepage would about fill the interstices between the large rocks in the bottoms of these pits shortly after the loading and tamping was completed.

One Victor No. 6 electric fuse was used in each charge, all being connected in simple series of 24. The connecting wire in each tunnel was trailed along at the junction of the floor and wall and covered with several inches of fine muck for protection while loading and tamping. All cross cuts were entirely filled, as well as the tunnels, to within 10 ft. of the portals with

"muck" from the tunnel floors. This material was well stowed away at the top of the tunnels to eliminate air space as much as possible.

All wiring was tested every two hours with a galvanometer during the entire time of loading and tamping, which took seven days, working day and night.

A No. 4 pull-up blasting machine was used to furnish electric current to detonate the fuses. This battery was first tested

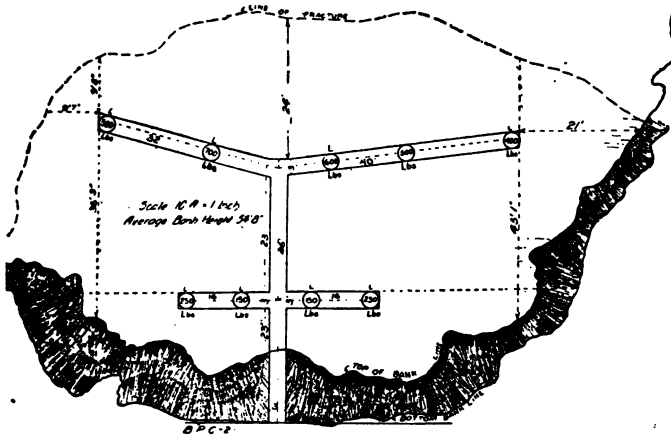

Fig. 103. Plan of Tunnels and Charges for a Large Blast at St. Helena, Oregon.

with a rheostat showing a capacity of 55 fuses, so there was plenty of excess current available.

The total breakage was estimated to be at least 350,000 cu. yd.; at a cost for explosives of not over 2.6 ct. per cu. yd., even though this shot was heavily loaded in order to get as fine breakage as possible. This heavy loading saved a good proportion of the cost of mudcapping and resulting delay to steam shovel work.

Fig. 103 shows the method of making a large blast in the crushed stone quarry of the Columbia Contract Co., at St. Helena, Ore. (*Engineering and Contracting*, Mar. 2, 1910). This company was getting out the stone for the jetty at the mouth of the Columbia River. The rock is a basaltic formation. It weighs 175 lb. per cu. ft. and has a specific gravity of 2.7. The explosive used was No. 2 formula M.V., bag Trojan powder and the charge was 3,500 lb.

The shot broke on the exact fracture line as was calculated

and shown on the drawing. The loading of the shot was proportioned as shown. It was the intention in loading this shot to shatter the entire formation as much as possible in order to put the rock through a crusher with the least possible expense.

Practically the entire excavation was handled with a steam shovel, scarcely any "bulldozing" being necessary. The first double T was driven for the purpose of loosening the strong toe at the portal of the tunnel. After each charge was loaded it was "mucked" (filled in with loose rock) for about 3 ft. back of the charge, then the tunnel was packed completely to the portal.

The time taken to load the shot was 16 hr., and the cost of loading was \$58. The cost of explosives was \$359, making a total cost of \$417. Exclusive of tunnel driving, the cost of the blast was 1.24 ct. per ton. The volume of rock broken was 14,280 cu. yd. so that the cost per cubic yard was slightly less than 3 ct.

A large blast (*Engineering and Contracting*, May 3, 1911) was made at Corona, Cal., for the purpose of securing rock for street work. About 250,000 cu. yd. of rock were broken up, and so successfully that a very small amount of rock had to be blasted before going to the crusher. The site of the blast was about 150 ft. from the Santa Fe railway tracks and near the railway water tanks. The hill formed a precipitous nose of rock about 80 ft. in height and consisted of a tough, blocky trachyte.

The main tunnel (Fig. 104A) was excavated on a line at right angles to the face of the cliff, for a distance of 110 ft. At 60 ft. from the face of the cliff a side drift was run 15 ft. to the left and another to the right 40 ft. in length. At 80 ft. from the face a drift 40 ft. long was run diagonally to the left. At the end of the main tunnel two drifts were run, each 50 ft. in length. The first was run diagonally ahead to the left and the other at right angles to the right. These drifts were each loaded (Fig. 104B) at the ends with Judson R. R. P. powder and 60% dynamite, the dynamite being proportioned 10% by weight to the Judson powder. The dynamite was used to explode the powder. The location and quantity of explosives were carefully estimated in each case, considering the weight of the material to be lifted and shattered, the rock formation and the contour of the hill. The height of the overburden was about 80 ft. The total explosive used was 30,000 lb. of powder and 3,000 lb. of 60% dynamite. Fig. 104A shows the distribution.

In placing the explosive the greatest precautions were taken. Men wore rubber shoes or tied gunny sacks on their feet to prevent any possibility of striking a spark on the hard rock. They were also searched for matches or other dangerous things which might cause trouble. Electric torches were used in place of candles.

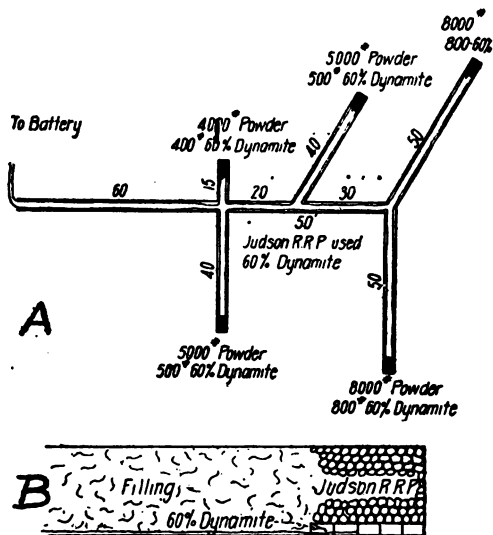

Fig. 104-A. Plan of Tunnels for Blasting.

Fig. 104-B. Manner of Loading Tunnel for Blast.

Chamber Blasts on Railroad Work. Mr. W. P. Hardesty describes the construction of the Portland and Seattle Railway in *Engineering News*, Feb. 13, 1908. The rock in this work was of volcanic origin; lava, usually a basalt, is the only rock found. The method of excavating along the high cliffs near Grand Dallas was by driving small tunnels $2\frac{1}{2} \times 3$ ft., called "coyote holes," into the hillside at intervals of about 50 ft. to a depth of 20 to 40 ft. From the end of each hole a "T" or cross-cut was run, and these were then filled with black powder and a string of them blasted at once. There was trouble in springing drilled holes preparatory to the use of black powder, as the brittle lava rock cracked far out and the black powder became lost in the fissures. Near Mosier, where the nearly vertical cliffs came down to the water, a large blast was arranged as follows: A small tunnel was run at the grade of the road 50 ft. into the cliff, from which two drifts were run at right angles, one for 75 ft. and the other for 45 ft. In these three openings black powder amounting to 1400 kegs of 25 lb. each was placed, with small rock tamped behind. The blast threw the cliff, for a height of 200 ft., and 50 ft. back, containing about 40,000

cu. yd. into the river and broke the rock into small fragments. Most of the rock fell where it was desired. It required nearly 0.9 lb. of black powder per cu. yd.

At Cook's Landing, in both loose and solid rock, a center cut with a maximum depth of 90 ft. was made by the same tunneling method. Four or five "coyote holes" about 80 ft. long were run into the hillside and "Ts" 40 to 60 ft. long were driven at their ends. The powder required was 2,385 kegs of 25 lb. each, all of which (except 500 lb. which failed to go off) was fired at once. Of the 90,000 cu. yd. in the cut nearly all was loosened so that it could be removed by the steam shovel. This required about 0.6 lb. per cu. yd.

The following data are given in *Engineering News*, Oct. 15, 1881:

A remarkable feat of railroad building has recently been

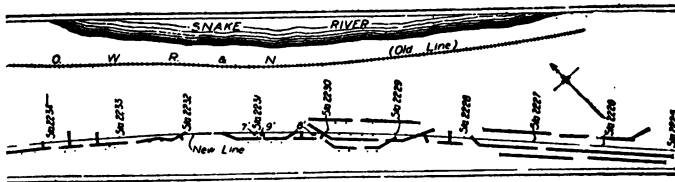

Fig. 105. Plan Showing Location of Tunnels.

undertaken from Portland to Dallas, Ore. The road will be 86 miles long. Much of the roadway must be blasted in the flinty face of lofty precipices, or drilled through no less unyielding rock. About 10 miles below Dallas is a bluff of basaltic rock rising 300 ft. from the Columbia River, along whose side the road is to pass. Men suspended by ropes 150 ft. over this wall drill and blast solid rock, their work being attended with the greatest danger. The largest blast on the line thus far has been at a point 10 miles above the Cascades, a mass of rock 165 ft. high, 170 ft. wide and 70 ft. thick at the base, containing more than 40,600 cu. yd., being removed by the explosion of 10,000 lb. of Judson powder, equal in force to 20,000 lb. of black powder. The heaviest shot on this work was at "Jacob's Ladder." At that point 420 cases, or 21,000 lb., of Judson powder moved 110,000 cu. yd. of solid rock. At "Shell Rock" 56,000 cu. yd. of solid rock were moved with 10,000 lb. of Judson powder.

The following is from *Engineering Record*, Feb. 24, 1912: Fig 105 is a plan of tunnels which were driven in order to blast a new right-of-way for the Oregon-Washington Railway and Navigation Co., along the banks of the Snake River in Washington.

Du Pont F to 5F black powder, in the amount of 431,000 lb., removed 400,000 cu. yd. of very hard basalt rock. Small tunnels ("coyote holes") $2\frac{1}{2} \times 3$ ft. in section, were excavated as shown. The total length of the cliff face mined in this way was 3,500 ft., and the aggregate length of 75 tunnels was 6,177 ft. The average length of tunnel was 89 ft. There were also 100 down holes drilled to within 20 ft. of the tunnels. About 400 cases of dynamite were used in preparatory excavation for the blast. The powder was spread in the pockets to a depth of 2 ft., covered with tar-paper, and then 4 or 5 in. of dirt. Tamping was then done without danger. "Coyote holes" contained from 1 to 11 pockets each with from 15 to 100 kegs in a pocket. About 60,000 cu. yd. of rock fell on the railway line, and traffic was suspended for 10 days.

Chamber blasting in limestone on the Union Pacific Railroad is described by Messrs. E. P. North and F. Collingwood (*Transactions American Society Civil Engineers* (1872), pp. 214-216). The cuts were about 18 ft. deep. The cost was as follows:

1st well:	
Labor, 18 days at \$3.00	\$ 54
Nitroglycerin, 15 lb. at \$2.00	30
2nd well:	
Labor, 13 days at \$3.00	39
Nitroglycerin, 11 lb. at \$2.00	22
111 kegs of powder at \$10.00	1,110
120 ft. of fuse at 3ct.	4
Logs, loading, etc., about	25
Total blasting	\$1,284
Loading material left in cut into carts, 18 men 6 days, at \$3.00	324
Total blasting and loading	\$1,608

About 1,600 cu. yd. were excavated and loaded at about \$1 per cu. yd. To which is to be added for superintendence, carting, etc., about 10% making a total of \$1.10 per cu. yd.

Large Chamber Blasts. The approaches to a short tunnel were excavated by the chamber method of blasting. The approaches contained approximately 40,000 cu. yd. of earth and rock, 75% of which was earth. Nearly 50% of this was moved by two blasts, one on each approach, 30,000 lb. of powder being used. The powder in these instances was placed in powder tunnels running about on the ditch line, with branch tunnels leading from the main. The powder was emptied into paper flour sacks and then packed as closely as possible in the extreme end of the main tunnel and branches. After the powder had been placed the balance of the tunnel was filled with earth packed in as well as possible. The fuses and lead line in these blasts were tested at every step of the wiring of the blast.

While effective and satisfactory work was done by these two blasts it is believed that by the use of more powder somewhat differently placed, or had the dirt been better packed at the tunnel mouth, or had there been a solid stone or concrete wall built across the mouth of the tunnel, or in the tunnel next to the powder, better results would have been obtained. The powder tunnels were very dry and it is believed the powder would not have deteriorated much during the 48 hr. necessary to give a concrete wall time to set. The fact that there was evidence of considerable force wasted at the mouth of the tunnel was proof that there was a waste of powder.

Other Chamber Blasts. A large blast was fired March 3, 1898, by Carpenter Bros. to blow down an isolated mass of trap rock known as "Indian Head," near Fort Washington on the Hudson River. Two tunnels were driven; one near the water edge and 65 ft. deep; the other about 60 ft. from the top and 80 ft. deep. The face was 200 ft. high. Two 25-ft. shafts were sunk from the upper tunnel, and drill holes besides. A charge of 3,000 lb. of dynamite was placed in one tunnel, and 4,000 lb. in the other; and it was estimated that with the 7,000 lb. there were 350,000 tons of trap rock thrown down.

Mr. O. Guttmann, in a paper read before the *Institute of Civil Engineers*, gives data on chamber blasting on the Danube River. A spur of rock had a vertical face toward the river. A heading 3 ft. wide by 4 ft. high was driven in straight, and then a chamber 6 x 6 x 6 ft. made at right angles to it. The chamber was charged and the heading closed by brick set in cement and by dry stone packing. At first carboazotine was used, consisting of 74% potassium nitrate, 12% sulphur, 8% soot and 6% bran. It was a low-grade explosive; but, in one blast of 3.9 tons, 25,900 cu. yd. were thrown down where the breast was 60 ft. and the height 99 ft. The largest blast was in May, 1894, when 12 tons of second-grade dynamite (containing 45% blasting gelatine) in two chambers threw down 3 cu. yd. of rock for each pound of explosive, or practically the same as the carboazotine.

The formula used for charging the chambers was: $L = 3(v^3 + 5h)q$. In this L is the weight of charge in kilograms (2.2 lb.); v the line of least resistance in meters; h the height in meters of rock above, and q a coefficient depending on the explosive, being 0.22 for carboazotine. The term $5h$ may be dropped without sensible error. The formula then is almost identical with the formula: $L = 4.19 r^3 c$, used in harbor work at Fiume, where the ratio of height to line of least resistance was kept 3:2. Both these formulas give too high a charge, according to Guttmann.

Mr. J. A. Wilson; in a paper before the *Institute of Civil Engineers*, gives data on large blasts in New Zealand for harbor works. The stone was granite, gneiss and limestone used in large blocks. On an average 1 lb. of dynamite dislodged 10 tons of stone. Separate charges were proportioned in the ratio of the cube of the least resistance, and this cube of the line of resistance was divided by 35 for dynamite, 36 for gelignite, 43 for gelatine dynamite, 50 for blasting gelatine and 12 for black powder. Charges of $\frac{1}{4}$ to $1\frac{1}{2}$ tons were found most effective (a 3-ton charge broke up the rock too much); but this kind of blasting requires a line of least resistance of less than 40 ft. One or more free ends in the quarry with a vertical face are preferable. The length of adit was made nearly half the height overhead, and the chambers were a distance apart equal to 15 times the line of least resistance.

In *Engineering News*, April 2, 1892, a large blast at Brest, France, is briefly described. Galleries were excavated in the rock and charged with black powder, deposited in barrels covered by boards and tar paper to protect them from seepage water. The galleries were closed for a distance of 13 ft. by stone laid in cement mortar, and then about 7 ft. of dry stone work followed by 7 ft. of stone masonry again. Firing was done by electricity. The amount of powder is not definitely stated, but the author speaks of 40,000 lb. as being the maximum blast; and in the blast described 104,000 cu. yd. were broken, not a single stone being thrown from the quarry which was in a residential district. At times the ratio was as low as 1 lb. of powder to 11.7 cu. yd. of rock. The rules given below were followed:

(1) The distance between powder chambers should equal the thickness of rock above them.

(2) The face left after a blast should be as nearly vertical as possible to facilitate further work.

(3) With one powder chamber only, the distances from its center to the face of the quarry and to the top of the mass should be equal.

In *Engineering Record*, Aug. 10, 1895, Mr. F. A. Mahan tells of large blasts used at Genoa, Italy, in 1895. In limestone quarry, strata dipping 60 deg. toward the face, galleries were driven in the base at right angles to each other, and then the supporting pillars were all blown out at once, undermining an area 100 x 300 ft., allowing the strata above to slide down. When the strata were twisted so they would not slide, shafts were sunk from the top. One charge of 11,440 lb. of dynamite produced a land slide of 260,000 cu. yd. of rock without damaging surrounding dwellings.

A big blast in granite, at Long Cove, Me., is described briefly

in *Stone* (New York), 1896, p. 555, the data being as follows: A 4 x 4 ft. shaft was sunk 64 ft., then two drifts were run, right and left, each being 27 ft. long; at the end of these drifts cross drifts 26 ft. long were driven, to receive the explosives. Four men were engaged about 8½ mos. doing this work. Black powder was charged in waterproof canvas bags, the men working six days in complete darkness. In each of the two chambers on the west side, 180 kegs were charged; and in each of the two chambers on the east side 185 kegs were charged, making all told 730 kegs of 25 lb. each, or 18,250 lb. Thirty-two dynamite sticks,

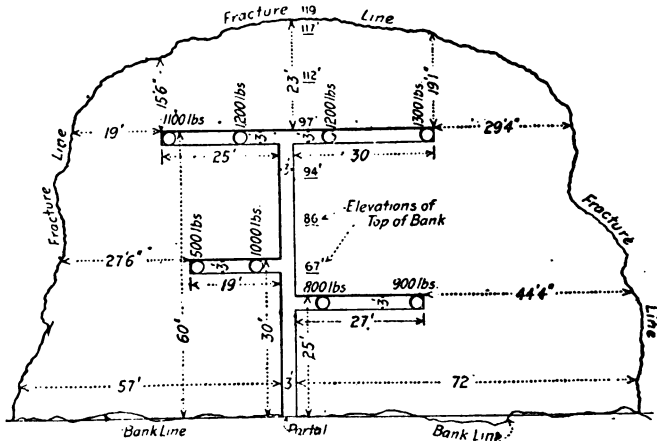

Fig. 106. Plan of Coyote Hole for Blast at Linnton Prison Stockade, Multnamah Co., Oregon.

each primed with a cap, were fired to explode the powder. After the explosion the ledge was 50 ft. higher than before (10-ton boulders were hurled 100 ft. vertically) and it was estimated that 1,000,000 tons of granite had been loosened. This appears to be altogether too high an estimate.

Mr. J. C. Costello (*Engineering News*, May 5, 1910) states that in a blast in solid basaltic formation, known as rhyolite, in Oregon, 54,800 cu. yd. were broken up with charges of 8,000 lb. of No. 2 Trojan powder fired in "coyote holes." This blast resulted in breaking almost 7 cu. yd. of rock per lb. of powder. The rock had a specific gravity of 2.78. The plan of the tunnels is shown in Fig. 106.

In the *Iron and Coal Trades Review*, Sept. 30, 1904, is given a brief description of the methods used in several Welsh quarries for 150,000 to 300,000-ton blasts. For the latter blast the

rock measured 216 ft. in height and from 84 to 150 ft. in thickness. Thirty-five men were employed in boring the main tunnels into the base of the rock, for a distance of 174 ft., the tunnels ranging from 5 ft. 3 in. to 3 ft. 2 in. in width. From the main tunnel air shafts were driven at right angles, 39 ft. apart, in which the dynamite was placed. The charges were laid in bags, 512 bags containing 12½ lb. and 72 bags containing 6¼ lb. each of the explosive. In all, 6,840 lb. of gelatin dynamite were used, equivalent to 67,200 lb. of black powder. In addition, six dynamite primers, each of 25 lb. were used. The chambers and tunnels were sealed with 350 tons of clay and rubble. The blast was a perfect success, not a single stone being hurled in the air. Some of the "boulders" weighed over 2,000 tons.

Blasting Cable Drill Holes. The method and cost of drilling the heavy side hill cuts on Pennsylvania R. R. work are given on page 267. The method of blasting these holes was as follows (*Engineering News*, Dec. 28, 1905):

The general plan was to blow out a triangular prism from the cliff face and to clear off a shelf with steam shovels which cast the debris into the river or loaded it on cars. The fills being very small as compared with the cuts, the economical plan was to throw as much rock as possible into the river at the time of blasting.

The Steigerwalts blast consisted in removing a headland 600 to 700 ft. long, and averaging 80 ft. deep and 100 ft. wide. The drills had to be lowered by block and tackle 135 ft. from the top of the cliff. Holes were drilled in rows parallel to the length of the cut. These were 80 vertical cable drill holes about 115 ft. deep and 123 horizontal percussive drill holes about 30 ft. deep. Drilling commenced July 1 and was completed Aug. 1; loading commenced Aug. 21 and was completed Aug. 22. Eight cable well drills and 16 percussive drills were employed continuously day and night for 30 days. Two hundred men and ten 4-mule teams were employed continuously for 22 hr. loading the holes. Special methods of handling the enormous amount of explosives had to be employed. The explosives comprised 2,262 boxes or 56.7 tons of dynamite, 278 boxes or 7 tons of Judson powder, 12,895 kegs or 161.3 tons of black powder, altogether 225 tons of explosives. There were also used 1,600 submarine exploders in lengths of 40 to 100 ft.

The cost was as follows:

Total cost of labor of drilling and handling explosives	\$45,391
Total cost of drilling and handling explosives	29,927
Total cost of blast	\$75,318

Rough estimates show 240,000 cu. yd. of rock loosened, which gives a cost of 31.3 ct. per cu. yd. About 73% of the rock was thrown into the river by the blast.

Little Jap hammer drills were used to break up large single rocks left from the main blast. Generally a hole 6 in. deep charged with a single stick of dynamite broke up the rock.

The cost of drilling with cable drills in copper mining is given in detail on page 270. The method and cost of blasting on this work were as follows:

The holes were sprung with two 50-lb. boxes of 40% dynamite, costing \$15.40 for 100 lb. Then the hole was reamed out, and from 20 to 30 kegs of black powder were used in the blast, the average being 25 kegs or 625 lb., costing \$2.25 per keg. This gave a total cost for explosives of \$71.65.

Assuming that a block, 35 x 40 x 60 ft., is broken by the hole, we have a total of 3,111 cu. yd. or 0.23 lb. of explosives per cu. yd. for both springing and blasting. This is a very small amount of powder to be used for rock blasting. The total cost per cu. yd. for drilling and blasting was:

	Per cu. yd.
Drilling	\$.010
Blasting023
	\$.033
Total	\$.033

This cost of $3\frac{1}{8}$ ct. per cu. yd. is very low for the hard material. On the other hand, for the earth overburden this cost is a little high; however, the cost given is an average for the two materials.

Method of Blasting at Grand Central Station. (*Engineering News*, Nov. 10, 1904.) It is often desirable to blast rock so that it will not be thrown away from the face but will be well broken and left in place. Fig. 107 shows a method pursued at Grand Central Station, N. Y. In some places the face was much higher than is shown. The rock was tough mica-schist. Two rows of "toe" holes were drilled about 19 ft. deep, 4 ft. apart. Two rows about 7 ft. apart, of vertical holes, spaced 5 to 7 ft., were drilled parallel with the side face. The "bench" and "neck" holes were first sprung. All holes were charged with Joveite or the equivalent 60% grade dynamite. By this method no rock was thrown on the loading track.

Blasting Hardpan. Hardpan, or cemented gravel, is usually

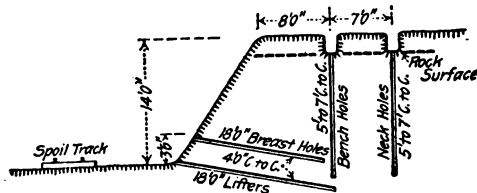

Fig. 107. Blasting at Grand Central Station.

exceedingly difficult to drill because of the "hard heads" or boulders scattered through the mass, and because of the clogging of the drill by the softer material encountered between the boulders or cobblestones.

If there are no large boulders in the hardpan, but merely a mass of small pebbles imbedded in clay, or cemented with iron rust, a cable-well drill can be used to great advantage. The holes drilled by the cable drill should be enlarged by springing them with dynamite and then charged with black powder or Judson powder.

Dynamite is not effective for breaking down a face of hardpan, because it gives a sudden blow that makes a chamber or pot hole and does not heave the mass of hardpan as does a slower explosive. For blasting hardpan for ballast purposes at Cohocton, on the line of the D; L. & W. Railroad, the holes were driven about 7 ft. deep, horizontally into the bank (not vertically), crowbars, post-hole diggers and spoon shovels being used in digging the holes which were about 8 in. diam. The holes were spaced about 10 ft. apart, charged with 4 lb. of Joveite in each hole and well tamped. *This method of digging horizontal post holes in the face of a gravel bank is one well worthy of remembrance.*

On the Chicago Drainage Canal, small tunnels about 2 or 3 ft. in diameter were run into the face of the hardpan. If a large boulder was encountered the tunnel was diverted so as to pass to one side of it. These tunnels were driven at the base of an 18-ft. face, and about 18 ft. center to center.

The late Prof. Thomas Eggleston, of Columbia University, is authority for the following data on bank blasting in California. While the blasting was done for the purpose of breaking up cemented gravel for hydraulicking, it is evident that the same methods are applicable in blasting hardpan for steam shovel work:

Bank blasting was introduced by J. F. Pierce in 1860, near Smartsville, Cal. Previously the banks had been broken down by undermining with picks, not infrequently burying the laborers. When very hard cemented strata make shaft sinking difficult, then tunnels are driven; but when the bank is not very high, small shafts are usually sunk and enlarged in the form of a bottle at the bottom to receive the powder. When a tunnel is driven it has a drift at its end forming a T. The end drift is about half as long as the main tunnel. Sometimes a cross drift is run at the middle of the main tunnel, and has a length about one-third the length of the main tunnel. The sum of the lengths of all the cross drifts should be about equal to the length of the main tunnel. The tunnels are made as small as the men can work in, generally 3 x 4 ft. The length of the main tunnel is

usually 1 to $1\frac{1}{2}$ times the height of the bank to be blasted, if the bank is a low one; but for very high banks its length is about $\frac{3}{4}$ the height of the bank. When the bank is 80 to 120 ft. high the main tunnel is made about as long as the bank is high. For such a tunnel about 600 kegs (25 lb.) of powder are used, 400 kegs being placed in the cross drifts at the end and 200 kegs in the cross drifts at the middle. In blasting very high banks it has been found wise to run short main tunnels connected with cross drifts parallel with the face of the bank: then to charge these cross-drifts and blow out the gravel between the cross drifts and the face of the bank, thus allowing the bank above to fall and break itself by its own weight. In bank blasting with black powder it is generally calculated that 1 lb. of black powder will break 2 to 3 cu. yd. of gravel. It is always better to use too much rather than too little powder, for too little may result in the loss of the entire charge. At the Enterprise Mine 1,700 kegs (25 lb. each) were fired at one time in a bank 250 ft. high.

In 1875 a blast of 17,500 lb. of powder was fired at the Paragon claim to break a bank 150 ft. high. The tunnel and drifts had a total length of 325 ft., in the form of a T. The main tunnel was 110 ft. long, the cross drift on the right side was 70 ft. long and had at its end another 55-ft. drift parallel with the main drift. The cross drift on the left side was 60 ft. long, and at its end had another drift 30 ft. long. The mouth of the main tunnel was tamped 75 ft. from the end, and the cross drifts were tamped 10 ft. each way from the main tunnel, which, with the width of the drift, made 100 ft. of tamping. A large amount of open space was left in the L drifts for the expansion of the gases. The electric battery was 450 ft. from the mouth of the tunnel, and the total length of wire was 1,500 ft. The running of the tunnel and drift cost \$300, and the explosives cost \$2,700.

A blast of 50,000 lb. of black powder was fired at the Blue Point Gravel Mine in 1870 that lifted 150,000 cu. yd. (1 lb. to 3 cu. yd.) of gravel vertically a distance of 6 to 10 ft. The main tunnel (3 x 4 ft.) was 275 ft. long. On the left there were six side drifts, each 120 ft. long, the first one being 75 ft. from the mouth of the main drift. On the right there were six side drifts, each 80 ft. long. On the first drift to the right was a drift 15 ft. long parallel with the main tunnel. The powder was equally distributed through the drifts, and was fired by electricity from ten different points.

In 1875, at the Dardanelles Mine, 36,000 lb. of Judson powder broke up 500,000 cu. yd. of cement gravel—a ratio of 1 lb. to 14 cu. yd.—although Judson powder is commonly regarded by bank blasters as being twice as effective as black powder

pound for pound. The face of the bank was 175 ft. high and 1,000 ft. long. Into this face five parallel tunnels were run, across each of which two or more cross drifts were cut at right angles. The total length of tunnels and drifts was 1,200 ft. The powder was charged in 28 lots of 1,000 to 2,500 lb., in each of which were placed three electric exploders.

In 1881 at the Blue Tent Mine 43,000 lb. of black powder were fired under a bank 200 ft. high.

In 1872, at the Harriman and Taylor claim, 3,500 lb. of dynamite broke down 200,000 cu. yd. of gravel, a ratio of 1 lb. to 57 cu. yd. This seems to be a very high ratio, for Prof. Eggleston tells of 2,500 lb. of dynamite loosening 75,000 to 100,000 cu. yd., or 1 lb. to 30 or 40 cu. yd., and adds that 1 lb. of dynamite is as effective as 5 or 6 lb. of black powder, which, however, does not accord with the data of the blasts cited by him.

While dynamite in small charges in drill holes is not effective for bank blasting, as I have had occasion to ascertain by test more than once, it appears to have been very effective when fired in drifts which were undoubtedly not packed solid with tamping, but in which large air spaces were left.

Mr. Oliver B. Finn gives (*Engineering and Mining Journal*, Vol. 78 (1904), p. 9) a description of the method used in blasting placers preparatory to dredging. A Keystone cable well drill was used to loosen very tight gold-bearing gravel deposits. The deposits were practically a solid mass of boulders, the voids being filled with heavy sand, so solid that the elevator dredge could not work economically. A line of 6-in. holes 50 ft. apart were driven about 30 ft. to bed rock. The first row was 20 ft. from the working face. After drilling, the casing was pulled up about 4 ft., the charge of 30 lb. of 80% dynamite in tin cans, 3 ft. x 4.5 in. in size, was lowered. The casing was then withdrawn, the hole filled with sand, and the charge exploded electrically. The explosion did not displace the bank but the cobbles were effectively loosened. The work served the double purpose of testing and drilling. The average cost of blasting was about 5 ct. per cu. yd.

Messrs. E. P. North and F. Collingwood describe (*Transactions American Society Civil Engineers*, Vol. I (1872), p. 214) the method used in blasting boulders embedded in compact clay in the construction of the Brooklyn pier of the East River Bridge. A solid iron pile, 18 to 22 ft. long by 5 to 6 in. in diameter was driven and withdrawn. The hole was then loaded with 13 lb. of powder and fired. The time of driving was about 5 min. and the cost of drilling, blasting and dredging was about \$3 to \$4 per cu. yd.

Blasting Glacial Drift, Mesabi District. The following de-

scription of the methods used in the Mesabi district of Minnesota is abstracted from *Engineering and Mining Journal*, Vol. 98, p. 696.

Two systems of blasting the ground to be excavated by steam shovels are followed in the Mesabi district, Minnesota, where the over-burden to be blasted is glacial drift. The usual method, where the bench does not exceed 25 ft. in height, is to drill holes 15 to 18 ft. from the edge and about the same distance apart.

By fastening a handle bar to the drill steel the steel can be lifted about 2 ft. by 2 men and dropped by its own weight. The men walk around in a 3 ft. circle, and in that way turn the drill. When a depth of about 20 ft. has been reached one or two dynamite cartridges are exploded at the bottom to spring the hole sufficiently to hold 10 to 15 kegs of black powder. The charge is fired by means of a detonated dynamite cartridge to give quick ignition, the hole being tamped with sand.

The other system, called "gophering," is used when the ground is so sandy and loose that a vertical hole cannot be kept open, and also when the bench is too high to drill from the top. The hole is bored from the side at a descending angle of 15 to 20 deg. A pointed drill-bar is driven in a few feet, and then withdrawn. Dynamite cartridges, placed end to end, are fired in this hole to loosen the ground, the "dirt" being removed with a long-handled shovel. This process continued gives a hole 10 or 12 in. in diameter. The lower end is then chambered as before to receive the black-powder charge. The powder is put in by means of a box, 3 x 3 x 15 in., attached to a 22-ft. pole. This box is filled with powder, and is pushed in and turned over to empty it.

Cost of Cemented Gravel Ballast. (*Engineering and Contracting*, Apr. 14, 1909.) In the territory east of Memphis cemented gravel is worked for the purpose of supplying ballast to railroads at Iuka, Miss., by the Tishomingo Gravel Co., of Memphis, Tenn. This is a water-worn gravel lying in a compact mass requiring blasting before it can be handled with a steam shovel. It is composed of 20% clay, 5% sand, and 75% gravel. This gravel as a rule is small and none of it large enough to require crushing to make it suitable for ballasting purposes. In order to get it in shape to load with steam shovel, it is loosened up by blasting. This is accomplished by digging a tunnel about 20 x 26 in. in cross-section into the material a distance of about 26 ft., then turning at right angles for a distance of 10 ft. This digging is done by a man lying down using a pick with a very short handle. The cost of digging these tunnels is 50 ct. per ft.

Tabulated Summaries of Blasting Data. Tables LVII and

METHODS OF BLASTING

TABLE LVII. PERCUSSIVE DRILL HOLE BLASTS

Rock	Kind of work	Ax. depth of hole	Ax. dist. of rows from face of hole	Ax. dist. apart holes	Ft. of hole per cu. yd.	Grade of explosive	Kind of explosive	Lb. of explosive per cu. yd. of rock	Diam. of hole, in.
	ft.	ft.	ft.	ft.	%				
Limestone	Canal	12	8	8	40	40	A	.75	..
"	Crushed stone	6	5	6	1.00	40	A	.70	..
"	Cement	20	50	A	.37	..
Hard dolomite	R. R. thro. cut	20	7	7	.42	60	Ab	1.15	4.5
Limestone	..	1543	50	A	.90c	..
"	Canal	14	4	6	..	{ 40	A	{ .38	..
"	Canal	13	8	6	..	{ 60	A	{ .38	4.5
"	Canal	13	8	6	..	{ 60	A	{ .38	4.5
Hard limestone	Crushed stone	{ 26c	9	6.5	0.47	{ 60	A	{ 1.35	{ 5.5
"	Crushed stone	{ 12f	6	6	..	{ 60	A	{ 1.35	{ 4.5
Sandstone	R. R. side cut	20	12-18	12-18	.10	40	{ B	{ 1.00	..
"	R. R. thro. cut	20	12-18	12-18	.20	40	{ B	{ 2.00	..
"	R. R. thro. cut	20	18	14	.15	..	B	.70	..
Soft shale	R. R. cut	20	12-18	12-18	.08	40	{ B	{ .75g	..
"	R. R. side cut	24	12-18	12-18	{ B	{ .70	..
Hard "	R. R. thro. cut	24	12-18	12-19	.20	40	{ B	{ 1.03	..
Granite	Bubble	16	5	5	1.36	60	{ A	{ 1.50j	..
Hard granite	Crushed, rubble	h	..	5	..	{ 75	A	.20	2.5
Gneiss	..	12	1.32	60	A	.60	..
Gneiss	..	1463	40	A	.50	..
Syenite	Mine	19	2.5	6e	1.73	40	A	.67	..
Iron ore	Mine	12.589	52	A	.44	..
Steamy trap	Crushed	1435	75	A	.20	..
Steamy trap	..	16	1.30	40	A	.70	..
Seamy slate	R. R. thro. cut	19j	10	10	.27	60	A	1.11	4.5
Seamy rock	Dam filling	1813	..	B	1.85	..

A. Dynamite; B. Black powder; (a) 35 holes; (b) holes sprung with 2 lb. of dynamite; (c) holes sprung; (d) 45 holes; (e) 60 holes, top holes, vertical, 26 ft. deep; (f) 75 holes, 2 1/2 holes, one at 15 and one at 60 with vertical, 10 to 14 ft. deep, the former being 16 ft. away from and 2.5 ft. in 26 ft. of latter; (g) sprung 3 times; (h) first row 6 to 15 ft. from face, 2nd row 7 to 10 ft. from first row; about 2.5 lb. 75% dynamite and 6.25 lb. of dynamite; (i) holes staggered; (j) 30 holes at angle of 15° with vertical, sprung with 3 lb. of dynamite.

TABLE LVIII. CABLE DRILL HOLE BLASTS

Kind of Rocks	Character of work	No. of holes	Diam. of hole, in.	Av. depth, ft.	Dist. of holes from face, ft.		Total explosive used, lb.	Grade of explosive, %	Kind of explosive	Rock blasted, cu. yd.	Explosive per cu. yd., lb.
					ft.	ft.					
Limestone c.	Crushed stone	4	5%	66.0	5500	..	A	20,000	0.275
Limestone	..	8	5	50.0	12	12	1200	40	A
Limestone	Cement Quarry	..	5	36.0	10	14	60b	40	A
Limestone	..	8	6	65.0	20	20	4000	40	A
Limestone	Open pit ironmine	..	6	20.0	15	15	65d	40	A
Limestone	R. R. ballast	8	6	48.0	19	18	3300	40	A	5,720	0.578
Limestone	{ 1800	{ 40	{ A	{ 12,820	{ 0.849
Limestone	Cement Quarry	9	6	62.0	32	20	{ 2500	{ 60	{ A	{ 6,610	{ 0.514
Limestone	..	7	6	60.0	23	15	{ 900	{ 40	{ A	{ 27,800	{ 0.249
Limestone	..	8	6	95.0	33	28	{ 3350	{ 60	{ A	{ 5,720	{ 0.315
Limestone	..	3	6	100.0	24	17	{ 600	{ 40	{ A	{ 13,060	{ 0.809
Limestone	Lime quarry	{ 1720	{ 60	{ A	{ 1,387	{ 0.199
Limestone	Cement quarry	9	6	52.5	36	20	{ 2500	{ 40	{ A	{ 12,000	{ 0.833
Sandstone a	Crushed sand	4	4	40.0	13	13	275	..	A
Porphyry	Copper mine	1	..	80.0	4000c	40	A
Basalt	R. R. thro. cut	578	4	25-40	f	f	{ 27275	{ 35	{ D	{ 35,000	{ 0.814
Copper porphyry	Open pit mine	..	5%	60	40	35	100h	..	A	3,100	0.323
Tough carbonate	5%	60	15	15	625	..	E
Gravel	Placer dredge	20	50	30	80	A
..	R. R. thro. cut	8	4.5	32-37	g	22	50300	2F-3F	E	12,113	0.811

A, dynamite; B, blasting gelatin; C, nitroglycerin powder; D, gelatin dynamite; E, powder; (a) cost of drilling per day; runner, \$2.50, helper \$2, electric power for drill, \$2, oil, sharpening, etc., \$1.50, total, \$3, 40 ft. per 10-hr.; (b) per hole; (c) per hole; (d) cost; drilling and charging, 4.3 ct. per cu. yd. (drilling by contract at 30 ct. per ft., explosive, 12 ct. per cu. yd., total 16.8 ct. per cu. yd., holes sprung with dynamite, cost; drilling at 58 ct. per ft., \$46, 4,150 lb. of dynamite at 10.6 ct., \$436; fuse and caps \$2, labor charging and incidentals \$17, total \$610 or 4.1 ct. per cu. yd.; (f) holes in 5 parallel lines; 1 center line, 2 lines 10 ft. away, 2 lines 24 ft. from center line. Holes staggered and 14 ft. apart. Holes chambered with 60 per cent. nitroglycerin powder. Cost of drilling was 27 ct. per ft. Loading required 8 days. (g) per hole; cost of drilling and blasting 3.3 ct. per cu. yd. for 40 x 35 ft. spacing; (h) holes on center line, the first being 18 ft. from face. Cost of drilling 50 ct. per ft. Holes sprung with 16 sticks of 60% dynamite, then 55 sticks, then 275 sticks. Tamping after springing cost \$12 to drill out. Total cost of drilling, springing dynamite, exploders, powder was \$3,725; (e) per hole, cost of blasting about 5 ct. per cu. yd.

LVIII give summaries of statistics regarding a number of percussive drill holes, cable well drill holes, and chamber and coyote hole blasts.

TABLE LIX

Notes on Chamber Blasting. Case I. West Beaver Creek, Col., dam tunnel 75 ft. below apex of rock, 135 ft. long with several bends. Cross drifts, each 35 ft. long, each way from end of tunnel. Charges at ends of cross drifts, with 3,000 lb. of powder along outer wall of remainder of cross drift. Tamping: rock, earth, timber.

Case II. Otay, Col., dam tunnel, 4 by 5.5 ft., 50 ft. long. Y-branches at ends. One chamber contained 4,000 lb. Judson powder and 50 lb. of dynamite; other contained 8,000 lb. of powder and 50 lb. of dynamite. Cost: tunneling, \$645; powder, \$960; charging, \$75. Cost: 3.6 ct. per cu. yd. Further breaking by powder in seams made total cost 5 ct. per cu. yd.

Case III. San Diego, Cal., Morena dam. Open cut run perpendicular to face. Parallel to and 100 ft. from cut, 4 by 5 ft. tunnel, 115 ft. long at end and 70 ft. from face chamber sunk beneath floor. Face chamber contained 500 lb. of 7% Champion powder and 1,500 lb. of 40% dynamite; rear chamber contained 28,550 lb. of 7 and 9% powder, 1,900 lb. of 40%, and 200 lb. of 60% dynamite. Tamping: earth, timber. Cost: open cut \$3,500, drifting and loading \$2,478, explosives \$3,116. Cost per ton 5 ct.

Case IV. Northampton, Pa., quarry; face 135 ft. high. Tunnel 3 ft. wide and 238 ft. long run along a fault 50 to 100 ft. from face. Four chambers 45 ft. apart formed below tunnel, and 3 cross-cuts run both ways each 25 to 56 ft. long. Total cost \$3,825.

Case V. Ferrino, Wash., quarry, 65 ft. face. Two 3.3 by 4 ft. tunnels 200 ft. apart. One tunnel 150 ft. long with 3 cross-cuts, each 70 to 100 ft. long. 60% dynamite. Tamping: muck, timber and cement bulkheads.

Case VI. Piedra, Cal., quarry, average height of face 91 ft., average overburden 68 ft. Six tunnels, each 80 ft. long, each with two cross-cuts driven both ways. Cross-cuts 40 ft. apart, 40 ft. long. Pits at ends of cross-cuts. 60% Hercules nitroglycerin dynamite and Judson R. R. P. Cost of explosives 2.6 per cu. yd.

Case VII. St. Helena, Ore., quarry. Tunnel 3 ft. wide, 46 ft. long. Y cross-cuts at end, with one branch 32 ft., and other 40 ft. long. Half way from face cross-cut both ways, 32 ft. long. No. 2 Trojan powder distributed in 4 charges of 150 to 250 lb. in short cut and 5 charges of 400 to 700 lb. in long cut. Cost: explosives \$359, loading \$58.

Case VIII. Corona, Cal., quarry. Overburden 80 ft. Tunnel 110 ft. long, with side drift 60 ft. from face, 15 ft. long to left and 40 ft. to right, a diagonal drift 80 ft. from face, 40 ft. to left, and at the end a diagonal drift 50 ft. long to right. End of drifts loaded with Judson R. R. P. powder and 60% dynamite.

Case IX. Union Pacific R. R., 18 ft. cut. Two wells loaded with 26 lb. of nitroglycerin and 2,775 lb. of powder. Total cost about \$1.10 per cu. yd.

Case X. Hudson River, 200 ft. face. One tunnel at bottom 65 ft. deep; other tunnel 60 ft. from top of face, 80 ft. deep. Two 25-ft. shafts sunk at top, and drill holes beside.

Case XI. Long Cove, Me., shaft, 4 by 4 ft., sunk 64 ft. with two drifts at bottom, each 27 ft. long. From ends of drifts, cross drifts 26 ft. long driven. Explosives in cross drifts. Estimate of 1,000,000 tons broken seems too high.

Case XII. Paragon claim hydraulic work. Face 150 ft. high, tunnel 110 ft. long. Cross drift at right 70 ft. long with drift at end parallel to main tunnel, 55 ft. long. Cross cut at left 60 ft. long with drift at end 30 ft. long. Large amount of space left untamped, for expansion of gases. Cost: tunneling and drifting \$300; explosives, \$2,700.

Case XIII. Blue Point Gravel Mine. Tunnel 3 x 4 ft., 275 ft. long. Six cross drifts, each 120 ft. long on left. Six on right, each 80 ft. long. First drift on right, 75 ft. from portal, has at end a 15-ft. drift parallel to main tunnel.

Case XIV. Dardanelles Mine. Face 175 ft. high, 100 ft. long. Five parallel tunnels across each of which two or more cross-drifts. Total length of tunnels and drifts, 1,200 ft.

Case XVI. Colorado, dam. Coyote hole, or one-man tunnel, 40 ft. long. Two cross-cuts from end, each 12 ft. long with pits at end. Explosive R.F.F. powder and 40% dynamite, loaded into pits. Tamping, earth. Cost: labor,

\$384; dynamite, \$155; powder, \$1140; caps and fuse, \$11. Total cost 16.9 ct. per cu. yd.

Case XVII. Oregon, railroad "coyote hole," 2½ by 3 ft., in hillside to depth of 50 ft. From end of hole T or cross-cut with one 75-ft. and one 45-ft. arm. Explosive charged in 3 openings.

Case XVIII. Crooks Landing, Railroad. Four or five "coyote holes" 80 ft. long, with Ts 40 to 60 ft. long at ends.

Case XXII. Snake River, Washington, railroad. 75 "coyote holes," 2.5 by 3 ft. averaging each 89 ft. in length, excavated into and then parallel to side hill face. 3,500 ft. of cliff mined by 6,177 ft. of coyote holes. 20,000 lb. of dynamite used in preparing for blast of F to 5 F. black powder.

Methods of Boulder Blasting. For a discussion of the different methods of blasting boulders see the last part of Chap. XV.

CHAPTER XII

LOADING AND TRANSPORTING ROCK

Units of Rock Measure. This subject has already been discussed on page 14, but it is well to state again that where I use the cubic yard as a unit it is the cubic yard of *solid* rock, "place measurement," unless otherwise stated.

The term "*muck*" is used in tunneling and mining to designate the blasted rock, therefore yardage of "*muck*" refers to loose measure.

Cost of Loading by Hand. Where a laborer has merely to pick up and cast one-man stone into a jaw crusher, I have had men average 34 cu. yd. of loose stone handled per man per 10-hr. shift, which is equivalent to about 20 cu. yd. of solid rock. This, I believe, marks the maximum that may be done, day in and day out, by a good worker, where the stone has scarcely to be lifted off the floor to toss it into the jaws. Every stone, however, was handled and not shoved or slid into the crusher. Going to the other extreme, where conditions are not favorable, where there are more or less delays at blasting, where there is some sledging and a little track laying, and where delays in getting cars are frequent, as in railway tunneling, one man will load about 3 cu. yd. of solid rock per shift (the range being from 2 to 5 cu. yd.).

On the Chicago Canal (see pages 664 to 666) the average output per man per 10-hr. shift was about 7 cu. yd. loaded into dump cars, and this included some sledging. The average per man loading into the low skips used on the cableways, involving very little sledging, was about 10 cu. yd. of solid rock per man per 10-hr. shift. The best day's record was 16.6 cu. yd. per man loading into skips. In loading cars about 5 men out of the force of 36 loaders were kept busy sledging the rock; but with the cableways not only was it easier to roll large rocks into the skips (or "scale pans"), but very large rocks were lifted with grab hooks and chains and carried to the dump without sledging.

In loading wagons with stone easily lifted by one man, the wagon having high sides, I have found that a man will readily average 10 cu. yd. solid, which is equivalent to 17 cu. yd. loose measure per day of 10 hr. The same man will throw the stone

out of the wagon twice as fast as he will load it, and this does not mean dumping the wagon, but handling each stone separately. In loading a wagon having a stone-rack, and no sides, two men, passing stone up to the driver who cords the stone on the rack, will load 1 cu. yd. solid stone in 13 min. when working rapidly, but this is too high an average to be maintained steadily for a full day. A driver will unload 1 cu. yd. solid (or 1.7 cu. yd. loose) from such a stone-rack, by rolling the stone off, in 7 min. if he hurries, but he may take 20 min. if he loafs. A man will readily load a wheelbarrow with stone already sledged and ready for the crusher at the rate of 12 cu. yd. solid (or 21 cu. yd. loose) in 10 hr.

Croes is authority for the statement that on Boyd's Corner Dam rough rubble stone was loaded onto wagons at the rate of 13 cu. yd. per man in 10 hr. The cut stone for this dam, during the years 1868-1869, cost about 30 ct. per cu. yd. to load on stone trucks, but in the year 1870 the cost was reduced to 13 ct. per cu. yd., wages being 15 ct. per hr., although it is not stated how this reduction was effected.

In quarrying mica schist for rough rubble in upper New York City, according to Mr. John J. Hopper the cost of loading wagons was 25 ct. per cu. yd., the rate of wages being 15 ct. per hr.

In moving several hundred yards of stone for rip-rap I have had 5 laborers load, haul 500 ft. on a flat hand car and unload, at the rate of 10 cu. yd. solid measure (17 cu. yd. loose) in 9 hr. per man. The stone was one and two-man stone, and was handled twice, once in loading and once in unloading.

The loading of stone by hand in the cement quarry of the Glens Falls Portland Cement Company, near Glens Falls, New York, is done by piece work. The rock consists of about 75% hard limestone and 25% very soft slate. This is drilled with holes 65 ft. deep, spaced 20 ft. back from the face and 20 ft. apart, and 6 in. in diameter, with a Keystone cable well drill, and shot with approximately 500 lb. of 40% Red Cross dynamite in blasts of from 4 to 12 holes. The large boulders are broken up for the loaders, who then break up and load the smaller pieces into cars. They receive about \$2.50 per day, at a rate of 10 ct. per ton, assuming the rock to weigh 2 tons per cu. yd. This loading is at the rate of 12.5 cu. yd. per man-day.

Cost of Unloading Stones from Scows by Hand. I excerpt the following data from a paper by Mr. H. F. Alexander (*Journal of American Society of Engineering Contractors*, Nov., 1911) who describes the methods pursued and the proper type of stone to use in building breakwaters at Lake Erie ports. The

core of these breakwaters is known as "quarry run" which consists of stones varying in weight from a few pounds to several tons. On the outside of the core heavy blocks of a minimum weight of 3 tons, with some weighing as much as 15 tons, are placed. The rock is conveyed on scows to the place where the breakwaters are being constructed. Three classes of scows are used, viz: derrick scows, deck scows, and dump scows. The smaller stone used for the core is, as far as practicable, carried in the dump scows. The latter are placed over the spot where the core is to be placed and are then dumped like mud scows. This is by far the cheapest method of handling stone, but only a limited amount can thus be handled. The larger stone, and occasionally loads of small or hand stone, are loaded on deck scows. The derrick scows also carry large stone and unload by their own derricks. No records of the cost of handling stone from dump or derrick scows are obtainable but the cost of unloading small stone by hand from nine deck scows was 10 ct. per short ton; the stone being unloaded at the rate of 2.6 tons per man-hour. With experienced ore shovelers a scow of 914 tons was unloaded at 8 ct. per ton, or at the rate of 3.33 ton per man-hour.

Cost of Handling Crushed Stone. In handling stone after it has been crushed to $2\frac{1}{2}$ -in. size, or smaller, a shovel is used, and the output of a man depends very largely upon whether he is shoveling stone that lies upon smooth boards or whether it lies upon the ground. I have often had 6 good shovelers unload a canal boat holding 120 cu. yd. loose measure of crushed trap rock (2-in. size) in 9 hr.; after breaking through to the floor the shoveling was comparatively easy; this is 20 cu. yd. loose (or 12 cu. yd. solid) per man per day shoveled into skips. In shoveling from flat cars into wagons the same rate can be attained, but in shoveling from a hopper-bottom car, where there is at no time a smooth floor along which to force the shovel, an output of 14 cu. yd. loose measure (or 8 cu. yd. solid) is a fair 10-hr. day's work. In shoveling broken stone off the ground into wagons it is not safe to count upon much more than 12 cu. yd. loose measure (or 7 cu. yd. solid) per man per 10 hr. A careful manager will, if possible, provide a smooth platform, preferably faced with sheet iron, upon which to dump any stone that is to be re-handled by shovelers. Small stone, $\frac{3}{4}$ in. or less in diameter, is easily penetrated by a shovel and need not be dumped upon a platform. A clamshell bucket operated by a locomotive crane is doubtless the most economic method of loading broken stone from cars or stock piles, where the quantity to be handled warrants the installation.

See pages 525 and 688 for further data, also refer to my "Handbook of Cost Data" for cost of crushing, handling and transporting.

Cost of Handling Crushed Stone with a Derrick. Where crushed stone must be handled with a derrick, as in unloading boats, I have found the following to be about the best that can be done per day:

	Per day
6 shovelers, at \$1.50	\$ 9.00
1 hooker on	1.50
2 tagmen	3.00
1 dumpman	1.50
1 water boy	1.00
1 team on derrick	3.50
1 foreman	3.00
	<hr/>
120 cu. yd. (loose) at 19 ct. =	\$22.50

It commonly costs about 25 ct. per cu. yd. (loose measure) to unload a boat of broken stone using skips holding 18 cu. ft. each, and a team on the derrick for raising them. Where any great amount of such work is to be done, however, a hoisting engine and a derrick provided with a bull-wheel should be used. The following shows the cost of unloading flat cars containing broken stone (2-in. size), using a derrick with a bull-wheel for "slewing" the boom:

5 shovelers, at \$1.50	\$ 7.50
1 dumpman	1.50
1 engineman	2.50
½ ton coal at \$3	1.50
	<hr/>
100 cu. yd. (loose) at 13 ct. =	\$13.00

In this case a stiff-leg derrick, 40-ft. boom, with a bull-wheel, operated by a double cylinder (7 x 10) engine, handled self-righting steel buckets holding 20 cu. ft. each. Water for the engine was delivered in a pipe. The engineman was the foreman.

In neither of the two cases just cited is the cost of installing the derrick included, nor is the interest and depreciation of plant included.

It takes 6 men and a foreman one day to dismantle and move a stiff-leg derrick a short distance (100 or 200 ft.), and one more day to set it up again. This includes moving the engine and the stones used to hold the stiff legs down; and it applies to a slow gang of workmen.

A guy derrick with a 50 or 60-ft. boom swung by a bull-wheel and a hoisting engine will often prove the cheapest device for loading cars with blasted rock. If the derrick is handling skips (Fig. 108) loaded with stone, the following is a fair average of the time elements in handling each skip load:

Changing from empty to loaded skip	35 sec.
Swinging (half circle)	20 "
Dumping skip	15 "
Swing back	20 "
Total	90 "

If there were no delays, it would be possible to handle 400 skip loads in 10 hr. Usually, however, the loaders will cause more or less delay, so that it is safer to count upon what they will average rather than upon what the derrick can do. One derrick cannot serve a very long face, and the number of men that can be worked to advantage in a given space is always limited;

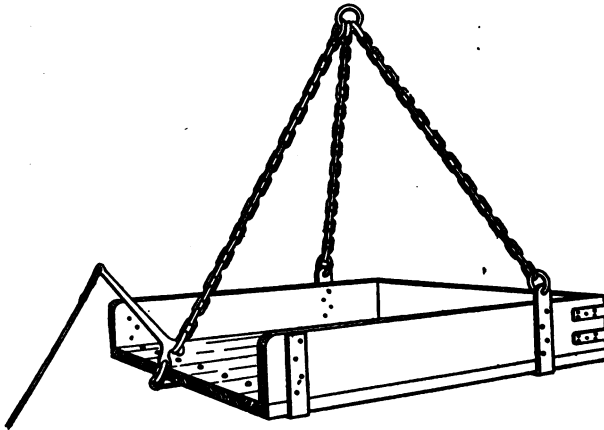

Fig. 108. Skip or Scale-pan.

hence I repeat that with a good derrick provided with a bull-wheel the derrick can ordinarily handle more stone than can be delivered to it by the men. The economic size of the skip load is entirely dependent upon the size of the hoisting engine, but a common size skip measures 5 x 6 ft x 14 in. deep. Where much work is to be done a contractor should never try to get along with a derrick not provided with a bull-wheel for "slewing" the boom, for the wages of two tagmen would soon pay for a new outfit.

For prices of derricks of various types and sizes see Dana's "Handbook of Construction Plant." The same book gives prices, weights and capacities of clamshell and orange peel buckets.

Price of Steam Shovels. The approximate prices of steam shovels are as follows:

TABLE LX.

Weight, tons	Price
120	\$14,500
95	12,700
85	11,250
70	9,250
60	8,500
45	7,000
40	6,500

Electrically equipped shovels cost about 25% more.

Bishop Derrick Excavator. This device consists of a dipper, dipper arm, and a carriage to support the arm on the boom of a derrick. It is operated like a steam shovel. The price of these machines, including the carriage, all attachments, teeth, gripping cable, but not the wooden dipper, are approximately as follows:

$\frac{1}{2}$ cu. yd. capacity	\$ 800.
$\frac{3}{4}$ " " "	900.
$\frac{7}{8}$ " " "	1,000.
1 " " "	1,050.

Cost of Loading with Steam Shovels. One who has never had experience in handling hard rock with steam shovels is almost certain to overestimate the probable output of a shovel, loading rock. This is due very largely to the common tendency to think of all rock as being a material that differs only to a moderate degree in hardness. Then again perhaps the frequently published accounts of steam shovels used to load iron ore have had a tendency to mislead the inexperienced man. The iron ore of the Mesabi Range, for example, is in reality a material that often requires no blasting and may be dug out of the bank with a powerful steam shovel using a small dipper. It should not be classed as a rock, but rather as a weak shale, as far as cohesive strength is concerned. A comparison of the work of shovels in ore and in other blasted rocks is given in subsequent paragraphs.

A soft shale that can be dug without blasting is just as much a rock as the toughest granite. Yet when it comes to loading rock with a steam shovel there is all the difference imaginable between shales and granites. Practically all printed records of shovels working in rock refer to shale, hardpan and soft iron ore. Among the printed records of shovel output in tough rock that blasts out in large chunks, the records kept by the engineers on one section of the Chicago Main Drainage Canal are most accurate and complete. I have given an abstract of these records on page 669. Two 55-ton shovels, each working two 10-hr. shifts a day for four months, averaged 292 cu. yd. of solid rock (limestone) per shovel per shift loaded into cars, although it is stated that one day one of the shovels loaded 600 cu. yd. of rock in 10 hr. The limestone on the Chicago

Canal did not break up into small pieces upon blasting (a condition that is essential to economic steam shovel work in rock), but it came out in large chunks, much of which had to be lifted with chains, instead of being scooped up by the dipper. When each separate rock must be "chained out" in this way, a steam shovel is really no better than a derrick, and is, in fact, not so good.

On a large contract near New York City, where the rock is a tough mica schist that breaks out in large chunks even with close spacing of holes, a 65-ton shovel with a $2\frac{1}{4}$ -cu. yd. dipper averaged for several weeks about 280 cu. yd. of solid rock per day, loaded on to cars. Part of this rock was loaded with the dipper and part was chained. Four men in the pit would fasten a chain around a large rock and throw the hook of the chain over one of the dipper teeth. The shovel would then deliver the rock to the car where a man unhooked the chain. The time required for these four pit men to fasten the chain around a rock ranged from $\frac{1}{8}$ min. to $2\frac{1}{4}$ min., and on the average was about 1 min. The operation of swinging the dipper both ways and unhooking the rock averaged about 50 sec. Thus a rock every 2 min. was averaged when working steadily; but delays due to shipping of chains, etc., would bring the average down to about one rock every $2\frac{1}{2}$ min., or about 240 rocks in 10 hr. Each rock did not average much to exceed $\frac{3}{4}$ cu. yd., since the rock broke out in long flat slabs—too long to enter the dipper, although much smaller in cubic contents than the dipper capacity. One of the features that should not be lost sight of in such work is the necessity of close spacing of drill holes in order to break up the rock to sizes such that at least a part of the chunks will enter the dipper. In this case the holes were spaced about $4\frac{1}{2}$ ft. apart. The foreman of this shovel work did not handle rock with the chain as fast as could have been done, for he should have provided an extra chain which the men could have been fastening to another rock while the shovel was unloading into the car.

On the Jerome Park Reservoir excavation in New York City the rock is also a tough mica schist that blasts out in slabs even with heavy blasting. I am informed by Mr. R. C. Hunt, manager for Mr. John B. McDonald, contractor, that their 70-ton shovels loaded only 300 cu. yd. of solid rock per 10-hr. shift. Mr. Hunt says:

"This was in the gneiss rock (mica-schist) of this vicinity. The fibrous nature of Manhattan and adjacent rocks causes it to break in such large and awkward shapes that the shovel cannot do itself justice. I therefore abandoned the use of shovels in the rock cuts and find that I can handle the rock with derricks *more economically.*"

This statement agrees very closely with my own observation of other contract work on Manhattan, as above recorded. At the times of my visits to the Jerome Park work the holes were being drilled as follows: The face was 35 ft. high, and three rows of vertical holes were put down 25 ft., the rows of holes being 5 ft. apart and the holes in each row $7\frac{1}{2}$ ft. apart. A row of nearly horizontal holes was drilled 35 ft. below the top of the face, the holes being 5 ft. apart. All holes were loaded with dynamite and fired together. The five shovels were loading on to standard gauge flat cars which were unloaded at the dump with a Lidgerwood plow and hoisting engine; the cuts were side cuts.

In thorough cut work on the Wabash Railroad, one 42-ton shovel loaded 240 cu. yd. of sandstone (solid measure) into dump cars in 10 hr., as an average of a year's work; but about 10% of the working time was lost in breakdowns, etc.

In excavating in sandstone and shale in the coal measures, the work is commonly loaded with steam shovels. It is not safe to count upon more than 500 cu. yd. of shale, or 250 cu. yd. of sandstone per shovel per 10-hr. shift. The cost of drilling and blasting in these rocks is described on page 623.

Loading Shale with a Shovel on the Pennsylvania Railroad.

In shale, or any friable rock that breaks up into pieces that readily enter the dipper, the output of a steam shovel is far greater than in hard rock such as I have been citing.

The following data relate to the output of several shovels working more than a year, in shale near Enola, Pa., on the Pennsylvania Railroad. Each shovel worked two 10-hr. shifts per day, six days in the week. In cut No. 1 there were nearly 2,000,000 cu. yd., of which 85% was rock. Of this rock a little was very hard limestone, some was blue shale nearly as hard, and most of it was red shale, somewhat softer. Excluding the first two months, the average output of each shovel per month of double-shift work was nearly 31,000 cu. yd., equivalent to 15,500 cu. yd. single-shift work. There were, on an average, four shovels at work, averaging 60 tons weight per shovel. The best month's output was 47,300 cu. yd. per shovel in August, 1903, and the poorest month (after work was well started) was 20,800 cu. yd. per shovel in February, 1904, working double shifts. In cut No. 2 there were 1,130,000 cu. yd. of red shale, and while the monthly output per shovel was somewhat less than in cut No. 1, the digging was somewhat better. Three shovels were engaged 13 months, and each averaged 29,500 cu. yd. per month of double-shift work, equivalent to 14,750 cu. yd. of single-shift work. The average weight of each shovel was **60 tons**. The best month's work was December, 1903, in which

each shovel averaged 41,480 cu. yd. working double-shifts; the poorest month was January, 1904, in which each shovel averaged 23,850 cu. yd. The Allison dump cars used in this work have a capacity of about 4 cu. yd. struck measure; but, although heaped, the average car holds only 2.5 cu. yd. of shale measured solid in place. The cuts were all side cuts.

I spent considerable time in studying the excavation work being done during 1903 between Pittsburg and Philadelphia. Just west of Harrisburg there were 13 steam shovels at work removing some 4,000,000 cu. yd. (mostly shale) for the new gravity yards of the Pennsylvania Railroad. For the most part the cuts were side-hill cuts, and the grades of the temporary tracks were so level that a "dinkey" readily hauled a train of 10 cars, each holding 2.5 cu. yd. of shale, place measure. Each shovel was served by from two to six trains of cars, depending upon the length of haul, and there were few delays in waiting for cars—a vital point in securing economic results. I found that the night shifts loaded about 20% less material than the day shifts. The crew serving each shovel consisted of 6 pitmen, 1 pit boss, 1 engineman, 1 craneman, 1 fireman, 3 locomotive engineers, 3 trainmen, 1 switchman, 12 dumpmen and 1 dump boss. There were, besides, about 12 trackmen to each shovel grading new tracks, building temporary trestles, shifting track, etc. Most of the drilling of blast holes, which I have described in Chapter VII, was done with cable well drills. The shale broke up well upon blasting, often looking like a mass of chips. About 550 cu. yd. of shale loaded per 10-hr. shift was averaged by each 60-ton shovel, including all delays, working in side hill cuts averaging about 24 ft. deep.

The Use of Small Shovels. Small shovels are economical where the daily output is small but uniform, as in quarry work. The Linwood Quarries Co., at Buffalo, Iowa, used a Type I Thew Shovel in a limestone quarry. The Thew shovel revolves and the dipper has a horizontal crowding motion. The engineer did his own firing and the output was 250 cu. yd. (loose measure probably) per day. At Connelsville, Pa., a Type 0 Thew shovel loaded more than 200 cars of 1.5 cu. yd. capacity per day with 25% earth and 75% rock, mixed.

Outputs of Steam Shovels in Iron Ore. Each shovel required a crew of 1 engineman, 1 craneman, and from 4 to 12 (average 6) pitmen. The following data (Table LXI) were compiled from observations made by the Construction Service Co., and published in "Handbook of Steam Shovel Work," a report to the Bucyrus Company. A study of the outputs of these shovels will convince one of the value of properly spacing holes and blasting the rock. In badly drilled limestone, not a tough material, the

output of a 70-ton shovel was only 17 cu. yd. per hr., whereas in slate and limestone under similar conditions of working where the rock was well blasted, the output was as high as 154 cu. yd. per hr. Bearing out what I have previously said regarding the loading of ore on the Mesabi Range, the output of shovels in ore averages about 100% more than that of shovels loading rock. It will be noted that a 90-ton shovel loading from a stock pile made as much as 273 cu. yd. per hr. The yardages of output given in the table are all "place measure."

TABLE LXI. LOADING ROCK BY STEAM SHOVELS

Loading Iron Ore from Stock Piles and from Natural Beds.				
Report No.	21	22	23	24
Location	Chisholm, M.	Amasa, Mich.	Negovnee	Ironwood, M.
Material	Stock, iron ore	Do.	Do.	Do.
Conditions	Good	Do.	Ore frozen.	Good.
Size shovel, Tons	90	70	70	70
Dipper, cu. yd..	2 ½	2 ½	...	2 ½
Shift, hr.	10	10	10	10
Shifts per day..	1	1	1	1
Coal, tons	4 ½	2 ½	1 ½-2	2 ½
Oil, gals.	8 ½	1 ½	1 ½	1 ½
Water, gal.	7700	3500	3000	4500
Cars	{ Steel, 50-ton Wood, 35-ton	Wood 40-ton	{ Steel, 50-ton Wood, 30-ton	Steel, 40-ton
Engine	1-60-ton	{ 1-40-ton 1 lgt. eng.	1-65-ton	{ 1-hvy. eng. 1-switch eng.
Output, cu. yd..	2728	1500	1720	1512
Report No.	26	27	28	29
Location	Michigamme	Ishpeming	Hibbing, M.	Princeton, Mich.
Material	Ore natural	Ore, stock	Ore natural	Ore, stock pile
Conditions	Good	Good	Fair	Lack of cars, ore frozen
Size shovel, T.	70	...	95	70
Dipper, cu. yd..	2 ½	2 ½	2 ½	3
Shift, hr.	10	10	10	10
Shifts per day..	1	1	2	1
Coal, tons	1 ½-2	2 ½	2 ¾-3 ¼	2 ½
Oil, gals.	1 ¾	1	3 ¼	1 ¾
Water, gal.	3000	3500	5000	3000
Cars	20-ton 25-ton	{ Steel, 50-ton Wood, 40-ton	{ Steel, 50-ton Wood, 35-ton	{ Steel, 50-ton Wood, 30-ton
Engine	1-35-ton	1-35-ton	2-60-ton	1-Baldwin loco.
Output, cu. yd..	892.5	967	1350	916.5 to 893
Quarry Work				
Report No.	31		32	
Location	Thornton, Ill.		Thornton, Ill.	
Material	Blasted limestone		Blasted limestone	
Conditions	Fair		Good	
Shovel, tons	95		95	
Dipper, cu. yd..	2 ½		2.3	
Shift, hr.	10		10	
Shifts per day..	1		1	
Coal, tons	3 to 4		3 to 4	
Cars	5-cu. yd. cars in trains		Same	
Engine	4-30 ton		Same	
Output, cu. yd..	1245 to 730		916 to 778	
	Railroad Open Cut			

LOADING AND TRANSPORTING ROCK

511

Report No.	33	34	30
Location	Johnsonburg, N. J.	Johnsonburg, N. J.	Hopatcong, N. J.
Loading Iron Ore from Stock Piles and from Natural Beds			
Material	Blasted slate and limestone	Do.	Porphyry, Granite
Conditions	Good	Do.	Hard digging
Shovel, tons	70	70	70
Dipper, cu. yd.	2½	2½	2½
Shift, hr.	10	10	10
Shifts per day	1	1	1
Coal, tons	2.4 to 3.2	2.3 to 3.2	2.65
Oil, gal.
Water, gal.
Cars	4-yd. side dump— 10 in train	Do.	3½-yd. 7 in train
Engine	7-18 ton	Do.	2-18-ton
Output, cu. yd.	1542 to 865	1235 to 881	1200
Railroad Open Cut			
Report No.	35	38	38
Location	Columbia, N. J.	Hopatcong, N. J.	Hopatcong, N. J.
Material	Limestone	Porphyry, granite	Porphyry, granite
Conditions	Fair	Hard digging	Hard digging
Shovel, tons	65	70	70
Dipper, cu. yd.	2½	2½
Shift, hr.	10	10	10
Shifts per day	1	1	1
Coal, tons	2.8	1.7	1.7
Oil, gal.
Water, gal.
Cars	2½-yd.	4-yd.	4-yd.
Engine	3-18-ton	2-18-ton	2-18-ton
Output, cu. yd.	358	646	551
Canal Excavation			
Report No.	42	45	43
Location	Netcong, N. J.	Columbia, N. J.	Sault Ste Marie
Material	Porphyry	Limestone	Pottsdam Sandstone
Conditions	Hard digging	Fair	Badly drilled
Shovel, tons	65	70	70
Dipper, cu. yd.	2½	2½	2½
Shift, hr.	10	10	8
Shifts, per day	2	1	2
Coal, tons	2.2	2	2.3
Oil, gal.	3
Water, gal.	5
Cars	Side dump	2-yd.	4500
Engine, tons	12-16-18	18	4-yd.
Output, cu. yd.	630	264*	369
		242 to 168	14
			495 to 262

* Night shift.

In the open pit mining at Furnaceville, described on page 597, the iron ore, after being stripped of its overburden, is blasted and loaded by a steam shovel into tubs or skips. These skips are handled by a derrick which is mounted on a broad gage car. The daily (10 hr.) cost of handling skips is as follows:

Derrick Crew:

Engineman	\$2.50
Winchman	2.00
Fireman	1.75
¾ Tons of coal at \$3.50	2.62
Plant (estimated)	1.00
Total	\$9.87

The plant charges and the daily cost of labor and coal used

on the steam shovel for loading the skips is \$13.62. As the breast against which the shovel works is less than 3 ft. high, the output is low, being about 90 tons or 30 cu. yd. per day. The cost of loading is therefore \$0.45 and the cost of handling the derrick \$0.33 per cu. yd., making the cost a total of \$0.78 per cu. yd. for loading and handling.

In stripping this ore, the overburden, consisting of about half soil and glacial drift and half limestone, is loaded by a steam shovel onto skips of 5 cu. yd. capacity. These skips are operated on an inclined conveyor built by the Dobbie Foundry and Machine Company. This conveyor has made possible a great increase in the amount of overburden handled. The incline is 129 ft. in length and makes a waste bank about 60 ft. in height. It is possible to haul the skip to the top of the incline, dump and return in 30 sec., but naturally this speed is not maintained in the ordinary work. While one skip is being dumped, the other is in place for loading. The conveyor has housed at the base of the incline a 50 hp. double drum hoisting engine, each drum working independently of the other. There is also a steam winch for moving the machine forward. The machine is mounted on rails laid down for the purpose, and is moved by means of a rope, operated with a "dead man" from the winch. The conveyor is operated by four men, a hoisting engineer, a fireman, a winchman and a topman.

The cost of transporting and dumping with the conveyor per day is:

Engineman	\$ 2.50
Winchman	2.00
Topman	2.00
Fireman	1.75
2 Tons coal at \$3.50	7.00
Oil and supplies	7.00
Plant (estimated)	6.00
Total	<u>\$21.75</u>

This gives a cost of 1.5 ct. per cu. yd., for an average daily output of 1,500 cu. yd.

Cost of Steam Shovel Work in Slate. I am indebted to Mr. T. S. Bullock, President and General Manager, Sierra Railway Co. of California, for the following data: This company has two 43-ton Marion steam shovels with 1½-yd. dippers. One of these shovels worked from April 1, 1903, to April 1, 1904, in slate rock, all of which had to be blasted. In 300 working days of 10 hr. each this shovel loaded 199,000 cu. yd. into small horse cars, which is equivalent to 663 cu. yd. per shift. Had large cars been used the output would probably have been 15 to 20% greater. There were days when 800 to 900 cu. yd. were loaded, and at other times there were delays in waiting for

cars, when only 400 or 500 cu. yd. were loaded. This is an excellent record for a year's work.

I am indebted to Mr. Daniel J. Hauer for the following information: With a 65-ton shovel, provided with a rock dipper (shallow and broad) having a capacity of $2\frac{1}{2}$ cu. yd., the output for four months was 15,000 cu. yd. per month, working two 10-hr. shifts per day. The drill holes were 35 to 50 ft. deep, and the rock was granite and gneiss, somewhat disintegrated in places. The drilling was done by hand with churn drills, taking 6 men to pull a drill. The crews were as follows:

6 men, pit crew
8 men, drill crew
1 drill foreman
18 men, dump crew
1 dump foreman
6 men, extra crew
1 foreman.

The "extra crew" at times worked on the dump or helped the drilling crew, and two men were used to run a steam drill (receiving steam from the shovel boiler) in drilling block holes. The cost of repairs to the shovel was very high. The total cost for wages (double shift work), supplies, explosives, etc., was about \$8,500 per month. The large number of men on the dump was due to the fact that the rock was all rehandled in widening a fill.

Cost of Steam Shovel in Shale. I made the following observations on the Ohio Residency, Pittsburg, Carnegie & Western Railroad.

With a 35-ton Vulcan traction shovel, with a 1-cu. yd. dipper, 11 min. were consumed in loading 6 dump cars of 3 cu. yd. nominal capacity each. To haul this train 800 ft. to the dump and return, by a contractor's locomotive, required 6 min. Dumping one car at a time through a trestle took 3 men 3 min. for 6 cars.

The force employed was 1 boss, 1 craneman, 1 engineman on shovel, 1 engineman on locomotive, 1 brakeman on train, 1 engine-driver on water supply pump, 3 pitmen, 6 drillers, 1 blacksmith and 2 dumpmen.

The crew averaged 500 cu. yd. of material excavated in a 10-hr. day, the material excavated being mostly shale, with a face 10 to 15 ft. high. Though the shovel is apparently standing idle $\frac{1}{3}$ of the time, there is not so much lost time as appears. During the absence of the cars the shovel is moved forward, requiring about 3 min. to move 4 ft. and to block up.

Cost of Excavating Gravel and Boulders. The work was

located on the Ontario-Rice Lake Division of the Trent Valley Canal and is described by J. B. Brophy, Division Engineer, in the *Canadian Engineer*, Oct. 15, 1909. The records cover the month of June, 1908, when the shovel was making a side cut 10½ ft. deep in coarse gravel mixed with medium size boulders. The shovel loaded into cars as high as the crane would reach. From June 1 to 13, 16,000 cu. yd. were removed an average haul of 1,200 ft., and from June 15 to 30, 20,000 cu. yd. were removed an average haul of 1,400 ft. The total excavation was 36,000 cu. yd. hauled an average of 1,311 ft., and deposited in spoil banks averaging 10 to 18 ft. deep.

The plant employed and its approximate value were as follows:

65-ton Bucyrus shovel, 2½ cu. yd. dipper	\$ 8,500
2 12-ton Porter dinkeys	5,400
24 4-cu. yd. dump cars at \$220	4,480
17 tons rails at \$30	510
1,100 ties at 10ct.	110
Shovels, bars, etc., say	40
Total	\$19,040

Allowing 2% per month for repairs, depreciation, etc., gives a monthly charge of \$381 for plant.

The shovel, hauling and dump gang worked 12 hr. per day and the track gang and water wagon worked 10 hr. per day. The standard rates of wages were, per 10 hr., as follows:

Shovel runner, per mo.	\$125.00
Craneman, per mo.	90.00
Fireman, per mo.	60.00
Watchman, per mo.	45.00
Dinkey runners, per day	3.00
Brakemen, per day	1.75
Foremen, per day	3.50
Pitmen, per day	1.75
Oiler, per day	1.75
Laborers, per day	1.50
Water boy, per day	1.00
Teams, per day	5.00

As 26 days were worked during the month, the cost of the work and the organization of the forces, would therefore be:

1 Shovel runner	\$150.00
1 Craneman	108.00
1 Fireman	72.00
4 Pitmen	218.00
1 Team hauling water	130.00
52 Tons coal at \$5	260.00
Oil, waste, etc., say	10.00
Total	\$948.00
Hauling:	
2 Dinkey runners	\$187.00
2 Brakemen	109.00
1 Oiler	45.50
1 Trackman	45.50
48 Tons coal at \$5.00	240.00
Oil, waste, etc., say	14.00
Total	\$641.00

LOADING AND TRANSPORTING ROCK

515

Dumping:	
1 Foreman	\$109.20
16 Laborers	748.80
1 Water boy	31.00
Total	\$889.00
Track gang:	
1 Foreman	\$ 78.00
5 Laborers	195.00
Total	\$273.00
Miscellaneous:	
1 Superintendent	\$150.00
Proportion of timekeeper's wages	30.00
1 Watchman	45.00
Total	\$225.00
Interest, repairs and depreciation, estimated	\$381.00
Grand total	\$3357.00

Summarizing we have the following total and unit costs:

Item.	Total.	Per cu. yd.
Loading	\$ 948	\$.26
Hauling	641	.18
Dumping	889	.24
Track gang	273	.08
Miscellaneous	225	.06
Interest, depreciation, etc.	381	.11
Total	\$3,357	\$.93

Cost of Operating Electric Shovels. Mr. W. H. Patterson (*Electric Journal*, November, 1910) gives the following data relative to electric shovels.

Weight of shovel, Tons.	Size of dipper, cu. yd.	Hp. of motors.		
		Hoist.	Thrust.	Swing.
30	1	50	30	30
35	1¼	50	30	30
37	1¼	60	30	30
35	1¼	75	35	35
42	1½	75	30	30
65	2	100	35	35
95	3½	150	50	50
100	4	200	80	80

A Vulcan shovel used several years in loading gravel consumed approximately 100 kw. hr. of electricity per 10-hr. day. The average daily expense of operation was as follows:

Engineman	\$2.00
Craneman	1.75
Electric power at 1.5ct. per kw. hr.	1.50
Oil, waste, repairs, etc.75
Total	\$6.00

A shovel equipped with a 75-hp. hoist motor has been operated for several years loading gravel, clay and sand (hard digging). The crew consists of 2 shovelmen and 2 pitmen. The current consumption on a special test averaged 163 kw. hr. per 8-hr. day.

On ditch excavation in the Los Angeles Aqueduct (*Engineering*

and Contracting, Feb. 26, 1913), a Marion Model 60 electric shovel, working fifty 8-hr. shifts per month, consumed 11,370 kw. hr., or at the rate of 28.4 kw. per hr. during operation.

This shovel did admirable work in soft digging but was not able to compete with steam shovels in the very heavy work where many boulders were encountered. For a detailed comparison of the work of this shovel with steam shovels see pages 693, 694, etc.

Cost of Hauling in Cars with Locomotives. Chapters XV and XVI contain illustrative examples of the cost of hauling with "dinkeys" and large locomotives. For a full discussion of hauling in cars the reader is referred to my "Handbook of Earth Excavation."

Cost by Wheelbarrows. A wheelbarrow load averages about $\frac{1}{25}$ cu. yd. of solid rock. A man will load such a barrow in 2 min., and will walk with it at a speed of 180 ft. per min. if he is lazy and to 250 ft. per min. if he is active; and he will lose $\frac{3}{4}$ min. each trip in dumping the barrow, fixing run planks, etc. Assuming a speed of 200 ft. per min. and wages 20 ct. per hour, the cost of loading, hauling and dumping is:

To a fixed cost of 24 ct. per cu. yd. of solid rock add 8.5 ct. per cu. yd. per 100 ft. of one-way haul from pit to dump.

In this rule, and in the rules that follow, I have given not the lowest records of cost that I have, as will be seen by anyone who takes the pains to study this book well. I have preferred to give conservative estimates of cost in all the rules. It is never safe to estimate too closely before work has been actually begun; but once it is under way every cent per yard should be looked after with the greatest diligence. In a word, make your saving in your work and not in your preliminary estimate.

The foregoing rule applies to loading and transporting rock under fair conditions. When the work is hampered by lack of room, as in a tunnel or mine and when a large part of the time is spent in putting up runways, it is not safe to count on more than one-half the output given above. On the new Catskill Aqueduct, Walkkill Tunnel, the working force consisted of 3 foremen and 75 laborers divided into three shifts working 8 hr. each. This force put up runways, mucked the heading, wheeled the muck in barrows to cars at the face of the bench muck pile, about 100 ft., and shoveled the bench muck directly into cars. According to Mr. C. Raymond Hulsart (*Proceedings American Society Civil Engineers*, Aug., 1912), the output was nearly 150 cu. yd. of solid rock, or 250 cu. yd. of "muck," per day of 24 hr. This is 2 cu. yd. of solid rock, or 3.3 cu. yd. of loose muck, per man for 8 hr.

Hauling on Stone-Boats. For moving large stones a short distance stone-boats or sleds or "lizards" are often used. A stone-boat is a flat platform, ordinarily about $2\frac{1}{2} \times 4$ ft., on wooden runners shod with iron. It possesses three advantages over a wheeled vehicle: First, it is so low that a large rock can be rolled by hand, or dragged by the team on to it; second, it cuts no ruts into wet ground, and, third, it can be dragged about in narrow places. Obviously a team cannot haul a very large load very far on a stone-boat, but surprisingly large loads can be hauled a short distance if the team has long rests between loads. A team of horses weighing 2,400 lb. can exert a pull of about 1,000 lb. for a short time if they have a good earth foothold. The sliding friction of iron or wood on earth is about 50% of the weight of the load that is being dragged; hence a team is capable of dragging a stone-boat and load together weighing 2,000 lb. A team doing such heavy work could probably not average more than 2 hr. of actual pulling per day. In stone-boat work a stone weighing more than 1,100 lb. ($\frac{1}{4}$ cu. yd. solid) is seldom handled.

Where many such stones are to be hauled a considerable distance, as in boulder quarrying, I have found it an excellent plan to build "*skid roads*." A skid road is a rough railroad without the rails, for it is made by partly bedding in the ground round sticks of unsawed timber, like ties for a railway track, 3 to 6 ft. apart. A stone-boat with wooden runners, 8 to 12 ft. long, can be "skidded" or hauled along over these ties with ease if the ties are kept well greased. Indeed, a team can thus pull a bigger load than with a wagon wherever there is not a well-made road. Where growing timber is at hand a skid road may be made at less cost than grading a wagon road, and it possesses the inestimable value of being a good road even in wet weather. I have seen wagons that were dragged with difficulty through the mud when the load was less than $\frac{1}{8}$ cu. yd. of solid rock (550 lb.); and it often happens in the fall and spring of the year that $\frac{1}{4}$ cu. yd. of solid rock is a big load for wagons traveling over earth roads badly rutted and muddy. In such cases a skid road can often be built to advantage.

For moving boulders short distances to a steam shovel, to a derrick or even to the dump, a stone sled should be used. Where many boulders are to be moved to the dump use three sleds, and several chains for each team. Have a dump crew and a loading crew, and thus, with the extra sleds, keep the team moving. Boulders from $\frac{1}{4}$ to 1' cu. yd. can thus be moved a short distance cheaper than by blasting and loading into wagons. By having a number of rollers at the dump, the dump

crew can work the sled along on the rollers, using bars and levers, until it tilts up at the edge of the dump and discharges its load.

"Pole tracks" are described in the next paragraph.

Removing Rock from a Railroad Cut on Stone-Boats. On page 613 the methods and costs of excavating granite in open cuts on the Grand Trunk Pacific Railroad are described. The method of removing the spoil was as follows:

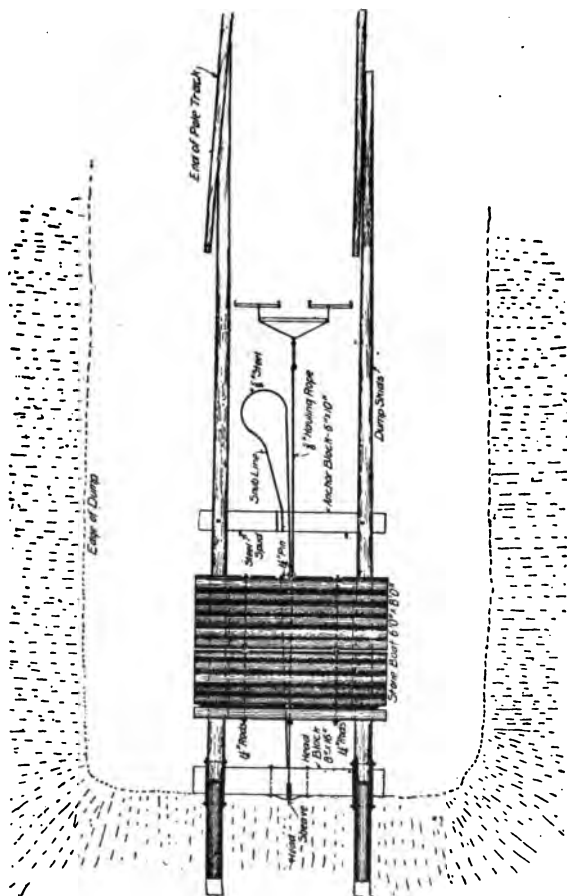

Fig. 109. Pole Track and Arrangement for Dumping Stone Boats.

The material was handled on stone boats and pole tracks and with small cars, loaded either by hand or small derricks. Stone boats running on *pole tracks* furnished the cheapest means of taking out rock where the haul was less than 600 ft. In winter the haul might be extended indefinitely. The track was made by laying two lines of tamarack poles 5 ft. 6 in. apart, for a two-horse team, or 3 ft. apart for a three-horse team. In the former case both horses walked inside the pole track; in the latter case only the middle horse walked between the poles. The poles should be fairly straight, 20 to 30 ft. long and 4 to 8 in. in diameter. The butt end of one pole is hollowed out for a foot or so to receive the top of the next pole, and the joint fastened with a 2-in. hardwood pin. The upper part of the pole is peeled, and even joints are kept so that the track can be shifted from side to side of the fill. See Fig. 109 for construction of stone boat and manner of handling it on the dump.

The stone boats were made of 10 to 12 tamarack logs about 7 in. in diameter and 8 ft. long, held together by two 1¼-in. hinged rods. The logs run crosswise on the pole track. Eye bolts are put in at the ends for hauling. In winter the pole track was iced, and in warm weather it was greased with black oil, about 1 gal. per 100 ft. being required each day. In winter a team would haul a 3-yd. rock and in summer a 1½-yd. rock. The average load on a 6 by 8-ft. boat is about ¾ cu. yd., weighing 4,000 lb. On a 500-ft. haul a good team and six men would take out from 40 to 60 boat loads per 10-hr. shift.

The average yardage moved per man loading was 7.3 cu. yd. per day. The cost of loading was very high, \$0.31, on account of high wages paid and because the large, irregular shaped masses are frequently rolled in front of the boat or to one side between the pole tracks by the loading team, and it required from 15 to 30 min. to block hole it and get it out of the way. Where the rock is broken up in small fragments it can be loaded twice as fast. The cost of hauling in stone boats was about 16.5 ct. per cu. yd., about 500 ft. haul.

Removal by Derricks and Cars. In the other approach to a tunnel, small stiff-leg derricks were used to load narrow gage dump cars. The cars were built on the work. The car platform was 6 x 8 ft. of 3½-in. hewed tamarack plank. The wheels were 14 in., and the gage was 30 in. The load carried by a car varied from ¾ to 2 cu. yd. One horse pulled the cars on a 1,000-ft. haul, taking 45 loads to the dump per day.

Stiff-leg derricks were used entirely on this cut. Sometimes two ¾-in. guy lines were put on, to steady the mast. All the wood work of the derricks was made on the ground. The derricks were used on cuts from 20 to 60 ft. deep. They were

placed on the side of the cut and shifted for every 40 ft. of advance. It required a day usually to shift a derrick. The derrick was taken down every time it was moved. A short gin pole was lashed and bolted to the top of the mast and guyed, then the stiff legs were raised clear of the center pin and lowered to the ground. The mast was then lowered with a snub line. After being moved to the new location the mast was raised with a team and blocks, the stiff legs hoisted and the "anchor boats" at the end of the stiff legs ballasted with about 4 cu. yd. of rock. The wages paid to men at work on the derricks per 10-hr. day were:

Engineman	\$3.00 to \$3.75
Lookout	2.25
Chainman	2.50

Cost of Hauling in Cars with Horses. For a discussion of the tractive power of horses and the rolling resistance of cars, the reader is referred to my "Earthwork" and to my "Handbook of Cost Data." On a level track a team will readily haul two dump cars loaded with 3 cu. yd. of solid rock over the ordinary narrow-gauge track with light rails. In railroad work the grade is usually in favor of the load from cut to fill, and it is safe to assume that one horse will haul two dump cars (1½-yd. body), each loaded with ½ cu. yd. solid rock. With a well kept track slightly in favor of the load, but not so steep as to stall the horse returning with the empty cars, it is safe to count upon ¾ cu. yd. in each of the two cars.

In a "thorough cut" the track is usually laid Y-fashion, the two branches of the Y being carried up close to the rock face. Two empty cars are left on one branch of the Y to be loaded while the two loaded cars are hauled away from the other branch. If the haul is short and only a few loaders are at work, only one car is hauled at a time. If the cut is wide enough, lay two parallel tracks and have two Y's, for in that way the loaders need not take so many steps to get a stone into a car, since there are four places at the face where cars may stand, instead of two.

In estimating the cost of loading and hauling in cars, using horses or mules, assuming the rock to be broken up into sizes that one or two men can lift, it is never safe to count upon more than 7½ cu. yd. solid rock loaded per man in 10 hr. and often it will be wise to estimate not more than 6 cu. yd. With wages at 20 ct. per hr., the loading costs 27 to 33 ct. per cu. yd. Assuming 1 cu. yd. of solid rock as a fair load for one horse to haul in cars; assuming 4 min. lost time in changing from the empty to the loaded cars and in dumping; assuming a speed of 200 ft. per min.; and assuming wages of driver and one horse at 30 ct. per hr.; we have 2 ct. per cu. yd. chargeable to lost time

at pit and dump, plus 0.6 ct. per cu. yd. per 100 ft. of haul (measured one way). The cost of dumping is largely a matter of how many yards are delivered per day at the dump. However, with wages at 20 ct. an hour, the cost of dumping is seldom less than 2.5 ct. and it may run as high as 7 ct. per cu. yd. Assuming 6 ct. as a fair average of the combined cost of dumping and lost team time, and 27 ct. as the cost of loading by hand, we have these rules:

Cost of Dump Car Hauling. For loading and hauling with dump cars, to a fixed cost of 33 ct. per cu. yd. of solid rock, add 0.6 ct. per cu. yd. per 100 ft. of one-way haul.

If the distance is great enough to warrant the use of a team of horses, instead of one horse, the cost of hauling will be 0.4 ct. per cu. yd. per 100 ft., if wages of team and driver are 40 ct. per hr.

I estimate the cost of laying a light track at \$100 per mile, of wear and tear on ties at another \$100, and of pulling up track at \$50, making a total of \$250 per mile, or \$5 per 100 ft. of track.

Prices of Cars. I am indebted to Dana's "Handbook of Construction Plant" for the following data:

A diamond frame double side dump car of wood and steel, costs as follows: (Fig. 110.)

Capacity, cu. yd.	Weight, lb.		Price.
4	6,000	Link and pin coupling and air brake	\$195
6	11,000	Automatic coupler, hand brake	275
6	11,000	Automatic coupler, air brake	325
12	28,000	Double trucks, automatic coupler and air brake ...	750

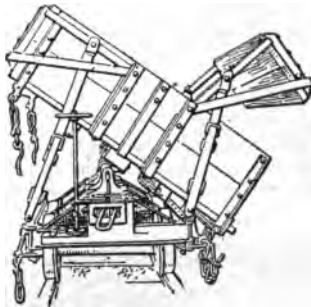

Fig. 110. Diamond Frame Double Side Dump Car.

A *two-way dump car*, diamond frame, of white oak, strongly reinforced with steel, costs as follows: (Fig. 111)

Capacity, cu. yd.	Weight, lb.	Trucks.	Gauge.	Brake	Price.
4	5,988	Single	36"	Hand	\$165
6	10,875	Single	36"	Hand and Air	255
8	16,500	Double	36"	Hand and Air	435
12	28,000	Double	Standard	Hand and Air	750

The manufacturers present the following figures:

Capacity of 4-yard car, 3.9 cu. yd.

Capacity of 8-yard car, 9.8 cu. yd.

Length of 4-yard car over all, 13.5 ft. — of 2 cars, 27 ft.

Length of 8-yard car over all, 22.5 ft.

A train of twelve 4-yard cars hauls 46.8 cu. yd. of earth.

A train of six 8-yard cars hauls 58.8 cu. yd. of earth; a gain of 25%.

A train of twelve 4-yard cars is 182 ft. in length.

A train of six 8-yard cars is 135 ft. in length.

Length saved in "spotting" by using 8-yd. cars, 47 ft.; a gain of 2% per train foot, and a 50% saving in time dumping. The increased diameter of wheels under an 8-yd. double-truck car enables a dinky to handle more yardage than with 4-yd. cars.

Double-truck platform cars with wooden frames and trucks with wooden or steel bolsters have the following capacities:

Capacity, Tons.	Track gauge.	Platforms.		Weight, lb.	Price.
		Length.	Width.		
8		20'	6'	6,000	\$220
10		26'	6'	9,500	300
12	30" & 36"	30'	6'	11,500	330
15	42" & 39.37"	30'	8'	13,000	400
20		32'	8'	18,000	475
25		34'	8'6"	22,000	520
30	4'8 1/2"	36'	8'6"	24,000	620

These cars are regularly equipped with hand brakes working on one truck only, and link and pin couplers. For brakes working on both trucks add \$12 to \$15. For automatic couplers add \$14 to \$20. For air brakes add \$50 to \$60.

Cars similar to above with steel frames and trucks cost 25% more.

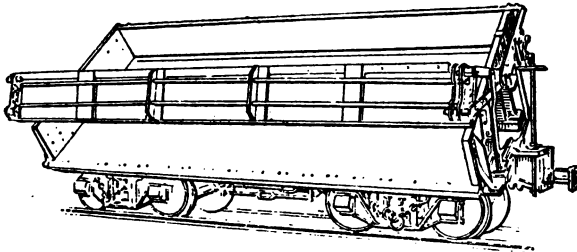

Fig. 111. An 8-Yd. Car in Dumped Position.

Cost of Hauling in Carts and Wagons. Since a cubic yard of loose, broken stone weighs about as much as a cubic yard of earth measured in place; and since, ordinarily, 1 cu. yd. of solid rock becomes 1.7 cu. yd. when broken, we may say that a team will haul about 60% as many cubic yards of solid rock per day as of earth. In other words, if the roads are such that 1 cu. yd. of packed (not loose) earth would make a fair wagon load for two horses, then 0.6 cu. yd. of solid rock would be a fair load.

In my book on "Earth Excavation" I have discussed in considerable detail the sizes of loads of earth that teams can haul, and it is only necessary to multiply the earth load as given there by 0.6 to find the equivalent load of solid rock.

Another way to estimate loads is to use the ton of 2,000 lb. as the unit. Solid rock seldom weighs more than 2.2 tons per cu. yd. Over poor earth roads, with occasional steep pitches, a load of 1 ton is practically all that an ordinary team should be counted upon to haul, or less than $\frac{1}{2}$ cu. yd. of solid rock. If the road is hard and level, a team will haul 1 cu. yd. of solid rock; or one horse will haul $\frac{1}{2}$ cu. yd. in a cart. If the road is a good gravel or macadam all the way, with no grades over 4%, and no pulls through soft earth, a good team can haul about $1\frac{1}{2}$ cu. yd. of solid rock, but these conditions are exceptional. In ordinary city and village work, and on level hauls over hard earth roads, assume 1 cu. yd. of solid rock as a load for two horses.

A team travels 220 ft. per min., or $2\frac{1}{2}$ miles an hour, at a walk over ordinary earth roads, a little faster over good pavements and a little slower over soft roads, the variation from this average of $2\frac{1}{2}$ miles an hour being seldom more than 20%, making it about 2 miles an hour over poor roads to 3 miles an hour over the best macadamized roads. It is perfectly safe to say that a team can walk steadily for 8 hr., averaging the speeds above given, going loaded and returning empty; so if the shift is 10 hr. long, and not over 2 hr. are lost in loading and dumping, the team has 8 hr. to travel, in which time it will cover 16 miles over poor earth roads, 24 miles over good macadamized roads and 20 miles over ordinary earth roads. If the hauls are short it may happen that so much time is lost in loading and dumping that the team has considerably less than 8 hr. of actual walking time left.

As to the wagons used for hauling one and two-man stone, my own preference is for an ordinary wagon from which the box has been removed and replaced by a "stone rack." A stone rack is 3 ft. wide and 11 ft. long, its floor being 3 in. plank and its sides and ends nothing but 3 x 4-in. strips. This makes a "box"

that is low and easily loaded, when necessary big stones being rolled up an inclined plank onto the wagon. It is also unloaded easily, large stones being simply rolled off without lifting. Where hauls are very short, and the stone all broken to one-man size, a dump wagon may be used advantageously; but such a wagon always weighs much more than the common wagon with a stone rack, aside from the fact that it is always harder to load.

As above stated, a driver will unload 1 cu. yd. solid measure (or 1.7 cu. yd. loose measure) of stone from a stone rack in 7 min. if he is vigorous in his work. Certainly two men should never take more than 7 min. Two men and the driver can readily load 1 cu. yd. onto a stone rack in 15 min., no stone being heavier than two men can lift. Then if one man and the driver unload in 7 min., we have 22 min. team time lost in loading and unloading, which is equivalent to 14 ct. per cu. yd. (team and driver being worth 40 ct. an hour), 9 ct. being for lost team time loading and 5 ct. for lost time dumping. If, including rests, each laborer (exclusive of the driver), averages $7\frac{1}{2}$ cu. yd. loaded in 10 hr., and wages are 20 ct. an hour, we have 27 ct. per cu. yd. for loading. If one man, assisted by the driver of each team, does the unloading, the cost of his help need not exceed 4 ct. per cu. yd. We have, therefore, a total fixed cost of 9 ct. lost team and driver time loading, plus 5 ct. ditto unloading, plus 27 ct. for labor loading, plus 4 ct. for helper unloading, making a total fixed cost of 45 ct. per cu. yd. of solid rock. The rule for cost of loading and hauling and dumping 1 cu. yd. of solid rock (2.2 tons) in wagons, under the above conditions, is:

Cost of Wagon Hauling. To a fixed cost of 45 ct. per cu. yd. of solid rock, for lost team time and labor of loading and dumping, add 0.7 ct. per cu. yd. per 100 ft. of haul (one way) from quarry to dump, or 37 ct. per mile one way; but if the roads are such that $\frac{1}{2}$ cu. yd. of solid rock (1.1 tons) makes a load, to the 45 ct. fixed cost add 1.4 ct. per cu. yd. per 100 ft. of one-way haul, or 90 ct. per mile one way.

By using extra wagons, as should be done where the haul is so short that a team cannot be kept on the walk 8 hr., or by using more men loading and unloading, as should be done when the hauls are very short, the fixed cost can be reduced to 38 ct. per cu. yd. instead of 45 ct.

In railroad work one driver usually attends to two one-horse dump carts; and as the rock cuts are usually higher than the dump the haul is down hill, so that, considering the rough roads, big loads can be handled. By having 4 or 5 men to load each cart, there is about the same amount of lost team time per cubic yard of rock as above assumed for loading wagons, or 9 ct. per

cu. yd.; the cost of dumping is about 2 ct., making a fixed cost for the two horses and driver of 11 ct. per cu. yd., to which add 27 ct. for loading to get the total fixed cost for labor and teaming. With wages at 20 ct. per hr. for laborers and 40 ct. for a driver and two one-horse carts, the rule for loading and hauling by carts, $\frac{1}{4}$ cu. yd. of solid rock per cart, is:

Cost of Dump Cart Hauling. To a fixed cost of 38 ct. per cu. yd. of solid rock add 1.4 ct. per 100 ft. of one-way haul.

Mr. Daniel J. Hauer states that he has found $\frac{1}{8}$ cu. yd. of solid rock to be a fair average of the size of one-horse cart load on railroad work, but my own records show $\frac{1}{4}$ cu. yd. to have been an average, and I have preferred to err, if at all, on the conservative side.

Where carts or wagons must be hauled up a steep, bad road, it will often pay to lay either a plank road, or to lay steel channel beams so as to form a trackway. This last method has been used with advantage where a hoisting engine was placed at the top of a long hill to relieve the teams of the work of hill climbing. A boy on a horse can readily drag the snatch rope back down the hill. In the far west it is customary for three or more teams to be hitched to a train of two or more wagons, and, when a steep hill is to be ascended, only one wagon is hauled up at a time. On long hauls this method could be used to advantage much oftener than it is in the east. Snatch teams are not used as often as they should be to enable large loads to be handled over bad spots in the road. Where the roads are fairly good all the year, traction engines are economic.

For hauling cut stone in large blocks, "stone trucks" are used. A stone truck is a strong wagon provided with a platform which hangs below the hubs of the wheels, instead of above them, as in the ordinary wagon.

Where large derricks are available at both ends of the haul, wagon boxes can be made so as to be lifted off by the derricks, both for loading and dumping the rock.

Cost of Unloading and Hauling Crushed Stone in Wagons.

The following data relate to the unloading and delivery of crushed rock. There was a macadamized or paved road from the unloading track to the beginning of the rock delivery. The road had low gradients, the worst being one hill 500 ft. long with 5% grade to pull loaded. The average haul was 8,855 ft. The number of cars unloaded was 26, making 409 wagon loads. The railway weight of the crushed rock was 1,582,700 lb. and railway weight of screenings 264,000 lb. The crushed rock weighed 2,100 lb. per cubic yard, the total amount being 753 cu. yd.; screenings weighed 2,425 lb. per cubic yard, and there were 108 cu. yd. The scale of wages was as follows:

	Per hr.
Shovelers	\$.20
Teams and driver40
Foreman (allowed)40

The cost of loading and unloading was as follows:

	Per cu. yd.
Shovelers	\$.092
Teams332
Foreman058
Blacksmithing042
Total	\$.524

In explanation of the blacksmith's bill it may be stated that the tires had to be set all round on eight dump wagons with 4-in. tires. A good rain at the beginning of the job would have saved 90% of that expense.

Comparative Cost of Hauling by Teams and by Traction Engines. Mr. H. R. Postle is also authority for the following:

"It will interest contractors to know that we were able to haul crushed rock cheaper with mules than with a traction engine, using the type of wagon ordinarily manufactured and sold to be drawn in train with an engine. The particular wagon used was the Port Huron 5-yd. or 6 ton wagon; each was fitted with a tongue, two mules being hitched alongside the tongue with three abreast in the lead. With a haul of about $\frac{1}{2}$ mile, each wagon made 10 trips per day of 8 hr., thus delivering on the road 60 tons of rock at a cost of \$7.50 (five mules at \$1.00 per day and \$2.50 per day for the driver) or \$0.125 per ton. To have hauled 60 tons of rock with 2-yd. wagons would have required two and a half 2-yd. wagons costing \$4.25 each (two horses \$2.00, one driver \$2.25) or \$10.65, which would make the cost \$0.177 per ton, which shows a saving of \$0.052 per ton by hitching more stock to one wagon and using a large sized wagon. The saving will increase with the length of haul. The coupling of two or three wagons together, or using a wagon of large capacity, with 4 to 8 head of stock is a very common California practice, and is one which the writer has failed to observe in the east. It is the writer's experience that this method of hauling, unless the haul be a long one, will generally be found to be cheaper than hauling by engines for the following reasons:

"(1). To load a train of wagons quickly requires either a private or specially constructed railroad switch and loading bins, or two trains of wagons, one of which is loading while the other is on the road. Loading wagons continuously one by one does not require so much in the way of switches, bins or wagons.

"(2). Most contracts demand an equipment easily and cheaply movable from one switch to another. It is seldom that all of *the loading can be done at one switch, consequently expensive*

equipment which cannot be cheaply and quickly moved, is not justifiable.

"(3). Horse equipment is better adapted to torn-up and dusty roads, which are sure to be encountered where construction work is in progress.

"(4). Horse drawn wagons are more easily handled on the sub-grade where the rock is dumped. They pull in on the sub-grade easier, do less damage, dump more quickly, and pull out and turn around quicker.

"(5). On very few contracts and on very few railroad switches can rock be delivered fast enough to justify the equipment required for engine hauling. The whole equipment where horse drawn wagons are used, the necessary unloading devices and the number of wagons, more easily fit the general run of contracts.

"Of the numerous contracts now under construction in Los Angeles County, where \$3,000,000 is being expended on macadam road construction, on only one is the rock being hauled by steam engines. It was tried on several others, but quickly abandoned."

Mr. K. I. Sawyer gives (*Engineering and Contracting*, Mar. 13, 1912) the cost of hauling crushed stone for roads in Michigan in 1910, using traction engines. The material from the crusher was carried by elevator into bins. The bins are so built that the engines and cars run under them to receive the contents of two compartments and receive the third from the end. All ports in the bins are on the bottom which is built horizontal. It took about 3 to 4 min. to load a 6-yd. wagon from the bin. The engines handled two to four wagons to a train according to climatic conditions. The usual practice, however, was to haul three wagons (18 yd.) which seemed to be enough as an extra wagon more puts too great a tractive effort on the engine for the good of the road.

Owing to the fact that the steam haulers were a new part of the county plant the last season a comparison was worked out to show the advantage of using this equipment. This comparison was taken directly from the schedule of actual costs of the road. In the work 12,177 cu. yd. of crushed stone were handled by the engines and 1,912 cu. yd. by team. This work was under identical conditions (except as to length of haul) and gives a basis of comparison. The team haul rate was 53 ct. per yard-mile. This would be considered high under normal conditions, but it was good under existing conditions. The conditions under which the hauling was done were very severe as is shown by the fact that it was possible to load only about a ton to the load for teams at the start, and even then it was necessary to double the teams over considerable of the road then built. Only good teams weighing 2,900 lb. to 3,400 lb. each were

used. The rates of wages paid were: Foremen, 30 ct.; engineer, 25 and 27½ ct.; overseer, 20 to 25 ct.; team (with driver), 45 ct.; labor, 17 and 20 ct. per hr. Coal cost \$4.50 f.o.b. scow.

The total cost of hauling 12,177 cu. yd. (loose measure) broken stone an average distance of 9,700 ft. (1.83 miles) was:

Labor	\$ 941
Coal, oil, etc.	814
Water	141
Repairs	164
Interest and deprec., 20% of \$6,200 plant	1,240
Total	\$3,300

This is equivalent to about 15 ct. per cu. yd. per mile. Using teams, and with an average haul of 2,300 ft., the hauling cost was 53 ct. per cu. yd. per mile.

Operations of Cableways at Arrowrock Dam. I am indebted for the following data of cableway operation to an article by Mr. Charles H. Paul in *Engineering News*, June 17, 1913. The work was the construction of the Arrowrock Dam, Idaho. The material handled by two cableways was blasted rock totaling 12,000 cu. yd. (solid measure) and 101,000 cu. yd. of packed river gravel and sand containing about 7% boulders.

The two cableways were made by the Lidgerwood Mfg. Co. They were stationary with a span of about 1,300 ft., capable of hoisting an average load of 8 tons on a 4-part line at a load speed of 300 ft. per min., and of conveying the same at a speed of 1,200 ft. per minute. The main cable was 2¼ in. in diameter of the patent locked type, and the hoisting, conveying, dumping and button ropes were ¾ in. in diameter, 19-wire hemp center. The hoists were triple friction drum, gear connected to a 300 hp., 2,200 volt motor. The conveying drum was 53 in. in diameter and each hoisting drum was 50 in. in diameter.

The skips were of ¾-in. steel, 8 ft. square and 2 ft. deep, with an open end. They were handled by means of spreader bars consisting of a piece of 3½-in. extra heavy wrought iron pipe 8 ft. solidly filled with a hickory filler, with heavy chains hooked into links on each side of the skip just ahead of the center of gravity, and a third chain to which the dump line was attached engaging a hook on the skip at the center of its rear end.

Due to the fact that the dam was curved in plan, and because of the topography of the country, it was not possible to place the cableways parallel to each other and thus command the work to advantage. The final location for these cableways was with *the head towers on the north side of the river about 275 ft. apart and with a common tail tower on the south side of the river, which was built to take a third cableway also if this was*

found necessary at a later stage of the work. Just in front of this tail tower was located the hopper over the screening plant, into which the material from the excavation was dumped. By this arrangement both cableways could dump into the same hopper at points about 40 ft. apart.

A row of skips numbering about 6 to 8 in a row was placed under each of the cableways. A drag-line excavator was moved to a point between the two cableways where it was out of danger from rocks that might fall from the skips, and these skips were loaded first on one side and then on the other so that there was always a loaded skip ready to be picked up by the cableways as soon as it had returned with an empty. Six hookers looked after the hooking and unhooking of the skips, the turning of them into the proper position for loading with the drag line, and the steadying of them as they were started off the ground by the cableways.

On account of the unusual height (about 275 to 350 ft.) to which these skips had to be lifted, the lines were very apt to become twisted unless the skips were carefully steadied before the hoisting began, but the hookers soon became expert in doing this work in the minimum amount of time.

The cableway operators could not see the operations in the pit, but handled the cableways entirely by signals received from signal men. Both the cableway operators and the signal men were provided with regular telephone operator head sets, and a special telephone connected them so that they were in constant communication. An entirely independent bell system was also installed, so that in case anything went wrong with the telephone there would be no delay to the work. As a matter of fact, it was the usual practice to use both systems at the same time, using the bells for start, travel, and stop signals and the telephone for the adjusting of the skip before lifting and just before landing.

Skips could easily be lifted from and landed at points 20 ft. or so on either side of the lines of the cableways, and with some little trouble and delay it was possible to handle them over much greater distance than this. Some of the excavation that could not be reached with the drag line was loaded into skips by hand, and it was sometimes necessary to resort to hand mucking in order to keep the cableways busy to their full capacity, for in some of the material encountered the drag line was not able to load the skips fast enough. Much of this portion of the excavation was handled without any shooting, but it was found of advantage to loosen up some of it with powder, and this work was always performed on the "graveyard shift" when the active operations of excavating were not in progress.

The drag line excavator was moved back and forth across the river (but always between cableways) so that it commanded a large percentage of the excavation. In the two corners at the south side, however, on account of the convergence of the cableways, the drag-line excavator could not reach all the material without getting under the cables, and much of this excavation was handled with stiff-leg derricks. Orange-peel buckets operated from these derricks did good work in handling some of this material as well as in digging the pump sumps. Skips were loaded by this means and handled in the same way as has been described heretofore. A large part of the material in these corners was loaded into skips by hand. In these cases the derricks were used to move the skips over within reach of the cableways.

The average height that a skip was raised was 300 ft., and the average distance of horizontal travel was 500 ft. from pit to dump. Three shifts were worked, a "morning shift" of 8 hr., an "afternoon shift" of 8 hr., and a "graveyard shift" of 6 hr. The average skip load was 2.5 cu. yd. "place measure." In about 3,450 working hours the following time distribution was observed:

	Per cent.
Hoisting and transporting	82.6
Service work	3.4
Delays:	
Electrical trouble	0.3
Engine trouble	2.1
Cable trouble	4.0
Miscellaneous trouble	1.8
No work	5.8
Total	100.0

The average time of moving a skip (delays deducted) was about 4.5 min., but the best shift's average was 3 min. 6 sec. (delays deducted), the record run being 149 skips in 8 hr. for one cableway. The morning and afternoon shifts each averaged about 7,000 cu. yd. per cableway per month when work was in full swing.

The cost of excavating the 113,000 cu. yd. (during July to Oct., 1912) averaged \$1.11, distributed as follows:

COSTS OF CABLEWAY OPERATIONS.

Drag line, loading skips:	
Labor	\$ 9,411.95
Fuel	2,357.40
Supplies	3,092.26
Repairs	1,801.81
Depreciation	2,025.26
Preparatory expense	1,012.63
Total	\$ 19,701.31

Derricks, loading and moving skips:	
Labor	\$ 5,203.01
Power	1,049.60
Supplies	267.25
Repairs	402.49
Depreciation	1,589.89
Preparatory expense	2,119.66
Total	\$ 10,631.90
Miscellaneous, hookers, and hand labor:	
Loading	\$ 38,683.61
Cleaning foundation	1,537.25
Miscellaneous minor operations	2,532.02
Total	\$ 42,752.88
Operating cableway:	
Labor	\$ 12,526.43
Power	4,472.69
Supplies	1,717.15
Repairs	5,314.11
Depreciation	7,280.51
Preparatory expense	10,429.30
Total	\$ 41,740.19
General preparatory expense	10,158.62
Total at \$1.11 per cu. yd.	\$124,984.90

NOTE: Coal is charged to the work at \$7.40 per ton.

Power is charged at 1½ct. per kw. hr., plus a proper proportion of the cost of maintenance of the electrical installation, lights, etc.

Depreciation on equipment is figured at a rate that will charge off against the work about 75% of the cost of the equipment and the total cost of installation.

Labor, \$2.40 per day of 8 hr.

Cableway operator, \$4.00 to \$5.00.

Drag line engineers, \$4.00 to \$5.00.

Derrick operator, \$3.50 to \$4.00.

Riggers, \$3.00 to \$4.00.

Cableway Used at Morena Dam. An interesting cableway installation and signal system is described by Mr. M. M. O'Shaughnessy in *Proceedings American Society of Civil Engineers*, vol. 37, p. 1123 (see also *Engineering and Contracting*, Nov. 15, 1911), as follows:

Construction operations were prosecuted with two Lidgerwood cableways, which were operated from towers about 300 ft. above the stream bed. The fixed cable was 2½ in. in diameter and 1,350 ft. long, covering the lower slope of the dam. The other cable was mounted on movable trucks, Fig. 112, which had a movement of 170 ft. on tracks at right angles to the axis of the dam, and was able to cover the whole of its water slope; this cable was 2¼ in. in diameter and 1,100 ft. long. Each cable was able to handle readily loads up to 10 and 12 tons. All the large rock was chained, and was either picked up by the cable directly or delivered to it by feeding derricks, and transferred by the cable to the fill; the smaller rock was carried in 6 x 8-ft. skips, each capable of carrying 2 cu. yd. It was possible to move the track trolley cable into a new position in about 2 hr., which

made a very convenient arrangement for moving the stone from the quarries directly into the dam work, where it was re-handled by derricks for the face masonry and back-filling.

Signaling Apparatus. In order to control the rapid operation of cables and the exact delivery of rock at certain points of the dam, and to communicate directions to the operating engineers, who were unable to see the work, a new system of signaling was devised. The system of bells used in the old days was abandoned, and an annunciator consisting of a box having ten compartments, each 8 x 8 in. deep, was placed within view of the engineer. The front of each compartment was closed by a pane of frosted

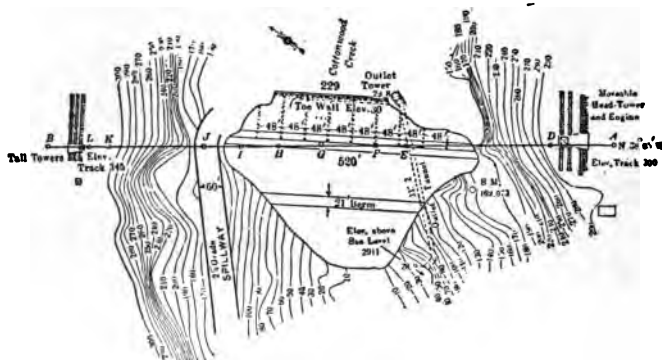

Fig. 112. Plan of Morena Dam, Showing Cableway.

glass and on these the following signals were painted: "HOIST," "LOWER," "GO OUT," "COME IN," "FAST," "SLOW," "STOP," and three spare spaces were left for special signals. At the back of each compartment were mounted two Edison keyless wall sockets with 16-c.p., 110-volt lamps. The lamps were wired with a common return wire and an individual wire for the other terminal of each lamp, making 11 wires in all. These wires were of No. 14 copper, covered and cabled, and the outside was protected by jute braid. Each flexible cable was 650 ft. long, and could readily be moved to any favorable position on the south or operating end of the dam. At the signaling end of the cable, ten switches were mounted and normally held open by a spring requiring the pressure of the operator's fingers to close it. The switches were mounted on an insulated base in such a way that the leads were brought into them without coming into contact with the wooden frame-work.

A $1\frac{1}{4}$ -kw., 125-volt, direct-current, compound-wound generator was used, operating at a speed of 1,650 r. p. m. The generator

was driven by one C. H. Dutton, 5-hp., vertical, steam engine, at a speed of 300 r. p. m. The engine was supplied with steam tapped from one of the boilers of the big Lidgerwood engines. A man, with the switch-signal board, was moved around the dam to the most effective points for observing the control and placing the rock as the work progressed, without interfering with guy wires and absolutely preventing accidents, for, in 2½ years of operation, not a man was injured because of any confused signals.

Cross-References on Cableways. For further data on the cost of handling rock with cableways consult the chapter on canal excavation, Chapter XVI.

See also Dana's "Handbook of Construction Plant" for prices and other data on cableway plants.

See my "Handbook of Earth Excavation."

Cost by Endless Rope Gravity Inclined Plane. I am indebted to a paper read before the West Virginia Coal Mining Institute, June 3, 1914 (Abstract in *Engineering and Mining Journal*, August 29, 1914), for the following data on the cost at the Gem mine of lowering coal from the mine entrance to a tippie on the railroad. The horizontal distance covered is 3,640 ft., the length of plane 3,700 ft., and the average inclination 16.8%. Two 36-in. gage tracks are laid on 6-ft. centers with 30-lb. rail. The rope is of plow steel, 1¼ in. in diameter, of 6 strands, 19 wires each. Five cars are lowered in a train, five or six loaded and the same number of empty trains being carried at one time. In 1913 there were 140,497 tons lowered in 268 days of 9-hr. each.

	Ct.
	Per ton.
Labor, 7 men	2.25
Rope (life 2 yr.)	0.70
Cost of maintenance, seven renewals of ties, roller, sheaves, grips, etc.	0.20
Total	3.15

Prices of Cableways. For the following data relative to cableways I am indebted to "Handbook of Construction Plant" by Richard T. Dana.

A *Duplex Traveling Cableway* was used by the United States government in excavating the Hennepin Canal. The cableway was purchased in 1903 and cost, complete and in operation, \$28,580. It consisted of 2 complete and independent cableway systems mounted on a single pair of duplex traveling towers. One tower served as a head tower for one cableway, the other tower served as a head tower for the other cableway. These towers were built of heavy timber well braced and ballasted. Each contained about 40,000 ft. B. M. of timber and 4,000 lb. of iron work. They were mounted on 47 x 54 ft. platforms supported by

48 standard car wheels set in two parallel frames 54 ft. long, and moved on 5 lines of rails laid parallel to the axis of the canal. These rails were so laid as to form two standard gauge tracks with centers 29 ft. apart, and one single rail between them. Each tower was equipped with a special 12¼ x 15 in. double cylinder cableway engine with 3 tandem 51 in. friction drums and a 125 hp. locomotive fire box boiler. The cableways were 18 ft. apart and had a span of 625 ft. Each was equipped with a 1½ cu. yd. orange peel bucket operated at the same time and independently. From Oct. 10 to Dec. 20 a total of 131,414 cu. yd. were excavated. The total operating expense for this period was \$11,546, divided as follows:

Labor, \$7,261; repairs, renewals, lubricating oil, kerosene oil for lights, waste, etc., \$3,528; coal, \$757. The operating cost per cubic yard was 8.8 ct. The item for repairs, renewals, etc., includes \$1,350 worth of new cables, but it is stated only about one-third of this sum could justly be charged to the operating cost of this period. During the period of operation for which the cost data are given the towers were moving over very soft ground. This made the track work expensive and was the cause of a number of extraordinary breakages; for instance, 3 crank shafts on the engines were broken. (See Fig. 113.)

A cableway used as a framework for a track carrying cars for making a fill was erected near Cleveland, Ohio. The fill was across a gorge 400 ft. wide and 95 ft. deep. One small trestle bent on each bank and one tall bent in the center were erected. Two 2¼-in. galvanized cables 7 ft. apart, were stretched over the bents and anchored to dead men of buried logs. The rails were spiked to ties which were fastened to the cables by U bolts. Small trestle bents were put in as the fill advanced. Turn buckles were placed in the cable to keep the suspended track taut.

Actual cost of aerial cable roadway:	
2¼ in. galvanized bridge cable, 1,000 ft.	\$ 600.00
Eyebolts, 2½ in. diam., with clevises for both ends	108.30
Turnbuckles at north end 3 in. diam.—two	120.00
Chains at north end, 2½ in. iron—two	62.40
Cast washers, 8 in. diam., 2 in. thick—four	2.46
Timber for A-frame (all other timber was obtained on ground):	
Upper 42 ft., 14 ft. x 8 in. x 8 in. All bracing and cross ties;	
3,800 ft., at \$34 per M.	108.80
Lower 50 ft., round timber, 56 ft. long; Rough in tree	32.00
Cost of team work for hauling round timber, and pulling timber to	
place for erecting	65.00
Carpenter labor on A-frame and end bents on bank	231.40
Time of superintendent, getting material and overseeing work in	
general	60.00
Common labor: Digging trenches for anchors and putting up	
cableway	112.00
Nails and iron in A-frame and bents	29.40
Total cost of cableway	\$1,531.76

Estimated cost of timber trestle:

Timber (all uprights, planks for bracing, stringers, etc.), 98,000 ft., at \$26 per M.	\$2,548.00
Labor, at \$6 per M.	588.00
Spikes	98.00
Iron drift bolts	40.00
Total	\$3,274.00
Balance in favor of cableway	\$1,742.24



Fig. 113. Duplex Cableways Used on Hennepin Canal, Operating Two $1\frac{1}{2}$ -cu.-yd. Orange Peel Buckets.

The cost of an average cableway without towers to carry a 5-ton load 800 ft. span with deflection at center of about 5% of the span, complete with guys but without towers, 12 x 12 engine working at 90 lb. to 100 lb. pressure, steam or air, with dumping drum without boiler is between \$6,000 and \$7,000 f. o. b. the manufacturer's works. The cableways operating by electricity, including 150 hp. motor with controllers and resistances cost about \$1,500 more than the above, or just about enough more to offset the cost of the boiler plant if a separate boiler has to be installed for the cableway.

Cost of Towers. One A-frame tower, guyed, for each end of this type of cableway will require a minimum of 5,000 ft. B. M. of lumber, with 14 in. x 14 in. sticks, costing about as follows:

Timber, 5,000 ft., B. M., at \$50	\$250
Labor erecting, about	125
Fastenings, freight and haulage, say	100
Total for 1 tower in place	\$475



Fig. 114. Sewer Cableway.

This tower can be taken down and reset for about \$50 plus the cost of moving to the new location. I do not know of towers of this type being built higher than 80 ft. and would advise against anyone attempting to construct A-frame towers higher than 65 ft. unless they have had much previous experience of the use of such very long sticks. The above figures are approximate, of course, and apply to average conditions in New York State. A 4-leg tower takes about three times as much lumber as an A-frame tower.

Traveling towers for a cableway cost from three to five times that of fixed towers under the same general conditions.

Repairs on a cableway may be counted at $\frac{1}{2}$ -ct. per cu. yd. of material handled.

Three cableways on the D. J. McNichols portion of Philadelphia Filtration System, Torresdale Filters, carried concrete, which

was handled in dumping tubs. Each cableway averaged 200 buckets per day of 10 hr., and a record of 330 buckets was made by a single cableway in one day. One of these cableways with a span of 825 ft. cost \$4,200 without towers. The towers were 64 ft. high. After being used three years this plant was sold for \$3,500.

A cableway for Baker Contract Co., at U. S. Lock and Dam No. 4, Ohio River, with a span of 1,485 ft. designed for a load of 5 tons, with 2¼-in. cable between 103 ft. towers, cost \$6,500, exclusive of boiler and towers.

Cost of Erection and Plant. The Croton Falls Const. Co., at the Croton Falls Dam, put in two cableways 1,434 ft. long, 2¼-in. cables, carrying 5 to 10-ton loads. The cost of one of these was \$8,000, exclusive of towers, tracks and boilers. The engine and boiler for this plant cost \$3,300, or 41.3% of the cost of the plant.

A report made by the Construction Service Co. shows the labor cost of erecting four towers and stringing cables for the two cableways was as follows:

Average height of towers: Head, 73 ft.; tail, 103½ ft.		
Carpenter foremen	49.25 at \$6.00 =	\$ 295.50
Carpenters	312.25 at 3.50 =	1,092.87
Hoisting engineman	104 at 3.00 =	312.00
Fireman	57.5 at 2.50 =	143.75
Laborers	330.5 at 1.00 =	528.80
Teams (labor only)	47 at 1.50 =	70.50
Foreman riggers	45 at 6.00 =	270.00
Rigger helpers	374 at 2.50 =	935.00
Machinist	4 at 6.50 =	26.00
Machinist helper	16 at 3.00 =	48.00
Foreman (laborers)	15.5 at 2.00 =	31.00
Cableway engineman	19 at 4.25 =	80.75
Signalman	23 at 1.50 =	34.50
Cableman	18 at 3.00 =	54.00
Total		\$3,922.87

Work Accomplished. On North Channel, St. Lawrence River, two cableways costing \$7,000, exclusive of towers and tracks, excavated over 500,000 tons of heavy stratified limestone. 75% of this was handled in blocks of 3 to 15 tons and 25% in 4-yd. skips, 20,000 to 25,000 cu. yd. handled per month the year around 1,000 tons per day was averaged. Delays on one cableway in 11 months due to repairs were 19 hr. and 49 min.

Moving Cableways. In the construction of the Southern Outfall Sewer, Louisville, Ky., two 700-ft. double Lidgerwood cableways were moved several times. Each time the cableway was dismantled and two traveling cranes assisted in the moving. The towers were 60 ft. high. About 20 men were employed in moving, and the cost of moving and setting up each time was between \$380 and \$400.

Output. On the Holyoke Water Power Dam a cableway with

a cable 2 in. in diameter, supported by a frame tower 20 ft. high on one side and a similar tower 100 ft. high on the other, set with a difference in elevation of the tops of 40 ft., was used for conveying materials. Most of the travel was down grade. The total span was 1,615 ft., total distance between anchorage 2,200 ft. A 50 hp. engine with two drums was used for hoisting. The average round trip to the center of the span with 3 cu. yd. took 10 min. This is at the rate of 18 cu. yd. per hr. or 180 yd. per day.

Life. In constructing the Rocky River Bridge at Cleveland, Ohio, a cableway with a 800-ft. span was used. This was mounted on towers which ran on rollers so that the whole machine could be shifted sideways. It was capable of carrying 10 tons. The main cable was 3 in. and the load line $\frac{3}{4}$ in. in diameter. Once every three months the main cable was shortened to take out the sag. The line had a life of 80 to 90 days and after being removed was used on small derricks, etc.

CHAPTER XIII

QUARRYING DIMENSION STONE

General Considerations. In this chapter the quarrying of "dimension stone" for masonry (other than concrete) will be discussed. Stone that is quarried and split with plug and feathers, or otherwise, to dimensions (ready for stone cutters to begin dressing the surface) is called "dimension stone." If it is quarried out in rough slabs or blocks of irregular dimensions it is called rubble stone, or backing stone, which is discussed in Chapter XIV.

In quarrying dimension stone the first step is to secure a working face in the quarry; the next step is usually to cut or blast a channel at each end of this face, so as to expose three free faces. Then it is possible, by wedging or blasting, to loosen a long block of stone which can be split into short blocks that can be handled by derricks. Where there is a good market for rubble stone, it is not customary to make end channels, but merely to shake up the rock for a short distance back of the face by light blasts, and, if it is a sedimentary rock, large irregular slabs can be barred and wedged out. These slabs can then be squared up by sledging or by plug and feathering, or both. Obviously this method produces a very considerable amount of rubble stone, but it is the common method in small dimension stone quarries.

While in the first chapter attention was called to the joints that exist in stone, it is well to add certain facts to those already given, for the art of quarrying is largely the art of taking advantage of joints and natural cleavage planes. Granite, which to the ordinary eye appears massive and without planes of natural cleavage, has in fact a "rift" clearly seen by the trained eye. Along this "rift" it may be split with comparative ease. Perpendicular to the "rift" in one direction are planes of cleavage, called the "grain," along which the stone splits with less ease; while perpendicular to the "rift" in the other direction are planes of natural cleavage, called the "head," along which it is still possible to split the stone, but with less ease than along the "grain" or along the "rift." These three planes of cleavage are shown in Fig. 1. All sedimentary rocks have a "rift" which corresponds with the planes of stratifica-

tion or beds; but the trap rocks, like diabase, diorite, porphyry, etc., often have no rift at all, and are consequently unfit for use as dimension stone, since when hammered or wedged they are apt to split, like glass, irregularly.

The cost of quarrying stratified rocks, like sandstone and limestone, depends largely upon two factors: First, the thickness of the beds, and, second, the "dip" of the beds. The "dip" is the angle, or slope, that the bed makes with a horizontal plane. If the beds lie horizontally, just as when they were originally deposited in the primeval sea, the stone is quarried out in successive layers; and, as these layers usually vary in thickness, the quarryman, after the quarry has been well opened, can select a layer of thickness to suit the demand of any particular purchaser. If the beds dip at a steep slope into the earth, the quarryman must usually remove thick-bedded and thin-bedded stone, all together, as he goes down; and besides he must abandon his quarry, or resort to mining methods, before a very great depth has been reached, because it will not pay to remove the increasingly large amount of stripping. On the other hand, where the beds dip at a high angle the quarryman can determine, by examining the exposed outcrop, what the thickness of each bed is, and can count with some certainty upon the character of each bed. Where the beds lie flat, the thin beds are usually on top, and thicker beds exist below; but this is not always the case, and to determine the character of the deposit diamond drill cores should be obtained.

If the beds of stratified rock are quite thin, the stone may be fit for flagstone, curbing, lintels, paving blocks, slope wall stone, basement masonry and the like; but will of course be valueless for heavy, architectural masonry or for engineering masonry where specifications call for thick courses. This simple fact is frequently overlooked by engineers in drawing masonry specifications, and they often call for thicknesses of courses that either are not to be found in local quarries at all, or, if found, are quarried only at great expense by first removing a lot of thin bedded stone overlying the thicker beds required. If the beds of stratified rock are thicker than the courses of masonry specified, then the quarried blocks must be split at a cost that should never be overlooked by the quarryman or the contractor in estimating a fair price for his product. Thus it appears that there is a happy medium as regards the economic thickness of beds.

Joints. All rocks, whether igneous or sedimentary, contain "joints," or seams that run through the natural beds. Often these "joints" are clearly visible, but at times the split may be so thin as to be invisible except to the expert eye. In strati-

fied rock the "joints" as a rule are perpendicular to the planes of bedding, and are spaced quite regularly, as if a giant quarryman had struck the rock with a sledge at intervals, cracking it in vertical planes. The joints in stratified rock have, as a rule, two dominant trends, one set of joints being parallel with the "dip" ("dip or end joints") and the other set at right angles, or parallel with the "strike" ("strike or back joints").

In granites and traps the "joints" occur at irregular intervals and often intersect at varying angles; nevertheless there are generally two sets of vertical joints intersecting approximately at right angles, and frequently there is a third set of horizontal or "bottom joints." If the joints are close together it will, of course, be impossible to quarry building blocks; though, on the other hand, the quarrying of stone to be crushed for concrete or macadam is greatly facilitated by numerous joints, as exemplified in the trap rocks of the Hudson River. Joints are usually quite conspicuous near the surface, due to the fact that changes of temperature have opened them, and solutions of iron salts passing through the joints have stained the rock. But wherever granite is found with numerous close joints in the surface beds, it may be inferred that similar joints exist in the lower beds even if they are invisible, and even if the blocks quarried from the lower beds appear solid. Merrill cites a granite quarry in which the stone at a depth of 25 ft. appeared to be perfectly solid, although above it was full of joints; but upon polished blocks he was able to discover fine hairline joints which eventually would doubtless open up upon exposure. I would suggest that tests on the tensile strength of diamond drill or shot drill cores would quickly prove the existence or non-existence of such joints.

Where joints in granite run vertically and at right angles to one another, as well as horizontally, the quarry is known as a "block quarry." Where there are practically no vertical joints, but where a series of nearly horizontal joints divides the granite into sheets or beds, the quarry is a "sheet quarry." The beds in sheet quarries are usually lenticular in shape, thin at the edges and thick in the middle. In such a quarry blocks 10 ft. thick and 300 ft. long have been loosened.

Plug and Feathers. Before studying the methods of quarrying it is necessary to understand certain of the commoner tools and machines. Among these the most important are the plug and feathers, shown in Fig. 115. These simple tools are used for splitting large blocks of stone into smaller blocks and for squaring up irregular stones. The plug is the wedge, and the feathers are merely two short pieces of half-round iron whose curved sides fit the sides of the drill hole, while their flat sides receive the

thrust of the plug. It is astonishing to see how thick a block of granite may be split with so small and simple a device. To split a block of granite, a row of holes about $\frac{5}{8}$ or $\frac{3}{4}$ in. diam. and $2\frac{1}{2}$ to 5 in. deep are drilled about 6 to 8 in. apart. Then a pair of feathers and a plug are placed in each hole, the plugs being driven home with light blows of a hammer until all are tight. Then each plug in succession is struck one or two blows, the quarryman telling by the ring of the metal under the blow whether the strain is practically the same in each wedge. With plug holes only 5 in. deep a block of granite 6 ft. thick can be split, leaving a face almost as flat as a board. For granite

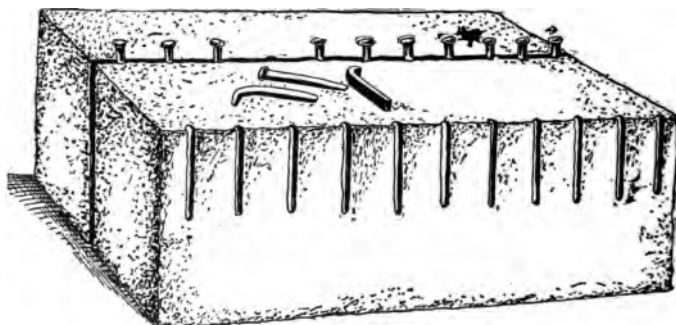

Fig. 115. Plug and Feathers.

blocks 3 ft. thick, a hole $2\frac{1}{2}$ or 3 in. deep will suffice. Some limestones also break remarkably well with shallow plug holes, but marbles and sandstones as a rule require deep holes, although with some sandstones holes $1\frac{1}{8}$ in. x 8 in. will break a sheet 4 ft. thick, perfectly true, according to Saunders. In most sandstones, however, the holes are usually $1\frac{1}{4}$ to 2 in. diam., and, as a general rule, of a depth equal to two-thirds the thickness of the stone. The holes are spaced 4 to 16 in. apart. In some sandstones the plug holes must be drilled entirely through the stone to insure a true break. The plugs need not always be of the same length as the depth of the hole. Sometimes it is found desirable to alternate deep and shallow plug holes in the same row. In this case the lower half of the deep holes may be drilled with a smaller bit, so that the plugs in these holes will strain only the bottom half of the stone.

For drilling plug holes there are three methods in common use: (1) Drilling by hand; (2) drilling with a pneumatic hammer, called a pneumatic plug drill; and (3) drilling with an ordinary rock drill mounted on a quarry bar.

Since plug holes in granite are seldom more than 6 in. deep (usually 3 in.), either hand drilling or pneumatic plug drilling should be used; but where deeper holes must be put down a rock drill on a quarry bar should be used. The cost of drilling holes with pneumatic hammer drills is so much less than the cost by hand, that the small machines have entirely superseded the hand tools in well conducted quarry operations.

Cost of Plug Drilling by Hand. By timing a number of

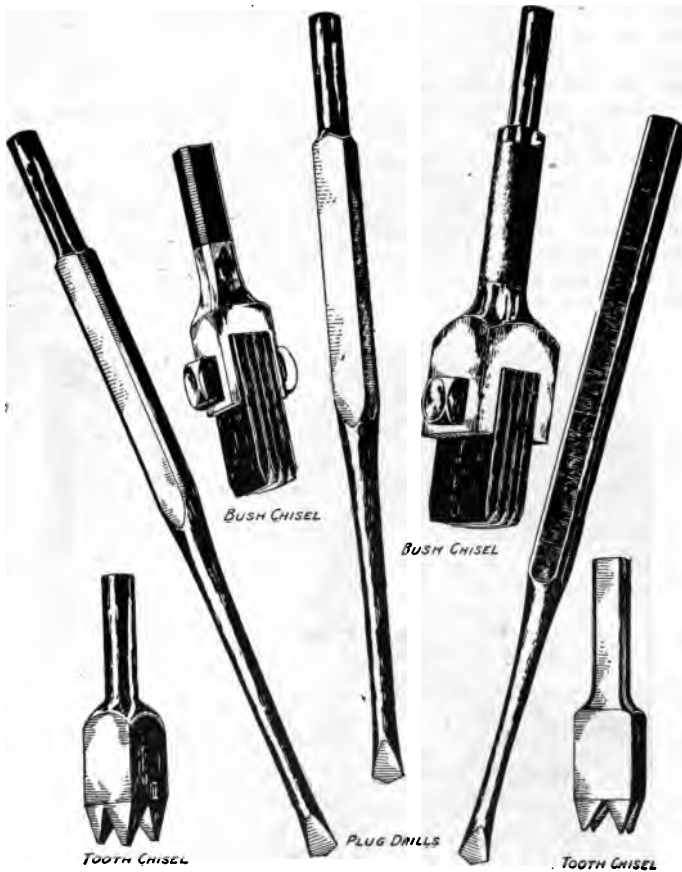

Fig. 116. Plug Drills and Chisels.

masons at work splitting granite blocks 24 in. thick, I found that each man drilled each hole ($\frac{5}{8}$ -in. diam. x $2\frac{1}{2}$ -in. deep) in a trifle less than 5 min., by striking about 200 blows; and it took about 1 min. for placing and striking each set of plug and feathers. Blocks 30 in. long, with four plug holes, were drilled and split with the plugs and feathers in 24 min., on an average. At this rate, a good workman can drill and plug 80 holes, or 17 ft., in 8 hr.

Since this block was 2 ft. thick it took 24 min. to split 5 sq. ft. of face. The mason was paid 30 ct. per hr., so it cost $2\frac{1}{2}$ ct. per sq. ft. to split the block. A block $1 \times 1\frac{1}{2} \times 1\frac{1}{2}$ ft. would have $10\frac{1}{2}$ sq. ft. of face on all sides, or it would contain .08 cu. yd., and would cost to split on all faces \$3.30 per cu. yd.

Further data regarding the cost of drilling shallow holes by hand will be found in Chapter II.

Cost of Pneumatic Plug Drilling. For drilling plug holes in granite certainly no tool is as economic as the pneumatic plug drill. Fig. 117 shows one of these drills at work on the Wachusett Dam granite quarry. It will be seen that horizontal as well as vertical holes can be drilled rapidly, which in itself is a distinct advantage over the quarry bar method. The plug drill shown in Fig. 117 does not rotate the bit automatically,



Fig. 117. Plug Hole Drilling.

which I consider a decided advantage since it simplifies the mechanism and reduces the wearing parts. The operator turns the bit with a wrench, which is such light work as to add little to his expenditure of energy. The ordinary plug drill, according to the manufacturers, consumes 15 cu. ft. of free air per min. at 70 lb. pressure (see Chapter IV).

At the Wachusett Dam I found that a workman averaged one



Fig. 118. Hammer Drill Drilling 15 ft. Holes.

hole ($\frac{5}{8}$ -in. diam. x 3 in.) drilled in $1\frac{1}{2}$ min., including the time of shifting from hole to hole, but not including the time of driving the plugs. About 250 plug holes are counted a fair day's work for a plug drill where the driller does not drive the plugs himself.

A portable, gasoline-driven air compressor serves admirably for plug drilling purposes in quarries where a large compressed air plant is not already installed. (See page 248.)

Data on the cost of drilling with air hammer drills will be found in Chapter VI and Chapter XVII.

The Use of Hammer Drills in Quarrying. The use of hammer drills in quarry work, particularly in rubble stone quarries, is rapidly coming into favor, and the following data from *Mine and Quarry*, May, 1911, gives some idea of the methods of employing

these handy little machines, as well as the cost of using them.

Use in Pennsylvania Limestone Quarry. Eight Sullivan DB-19 hand feed hammer drills, weighing 40-lb., were used in drilling holes up to 5-ft. in depth. Holes 4-ft. deep have been drilled in 18 min. and on a test, 3.3 in. per min. In this rock a 3¼-in. percussive drill made 80 ft. of 12-ft. holes in 9 hr.

Use in an Ohio Limestone Quarry. Blocks of soft sandstone about 8 ft. square are cut by hammer drills which put in 18-in.



Fig. 119. Blockholing.

holes in a line. A Sullivan DB-19 drill drove 20 holes at the rate of 25 sec. per hole.

Deep Holes in a Texas Limestone Quarry. A quarry of hard limestone operated at Jacksboro, Texas, is worked partially in 8-ft. faces, and here the drilling is done with Sullivan "DB-19" drills, employing hollow steel, Fig. 118. One 8-ft. hole was completed in 21 min. The following records of block hole work are from the company's books and were made with one drill: 106 to 213 ft. of hole per 10 hr. day were drilled, the holes being 2 to 3 ft. deep.

Drilling Sandstone. In an Ohio quarry Sullivan DB-19 drills

are used to break the stone into proper sizes after it has been freed on two sides by channeling machines. The stone is in horizontal layers 5 to 24 in. thick and separated by 1 to 2 in. of shale. Plug holes 3 to 8 in. deep are drilled with 1-in. hollow bits and the blocks split with plugs and feathers. An average rate of progress is 75 ft. per hr. In the grindstone quarries, where the stones are cut out round, the hammer drill

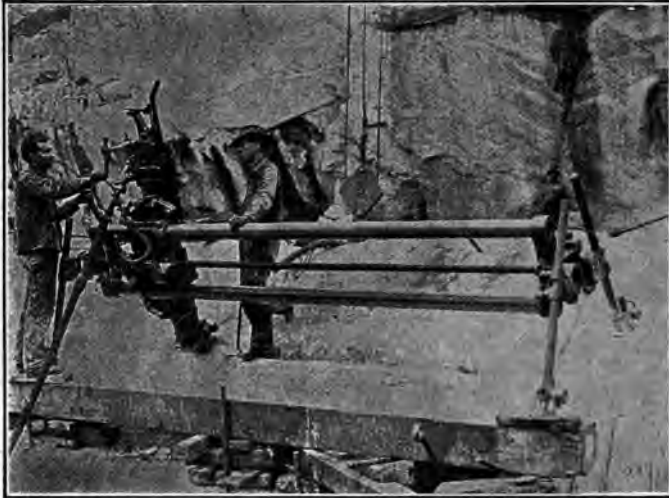

Fig. 120. Quarry Bar.

is used to put in holes 2 to 5 ft. deep under the stone to receive a small charge of powder. The work was formerly done by hand as the holes could not be properly placed with a tripod drill.

Use in Block Hole Work. Block holing in crushed stone quarries is another important function of hammer drills. A few years ago, an air compressor and Sullivan "D19" tools were substituted for hand labor at an eastern quarry, Fig. 119. It had previously required 18 hand drillmen to do this work. Six pneumatic drills, with one man on each, did as much as the 18 hand workmen. The rock at this quarry is very hard granite. The holes drilled in the rock fragments averaged 18 in. deep, although some ran to 36 or even 48 in. Hollow steel was used, sharpened with a cross bit, and the air pressure averaged 80 lb. The cutting speed ran as high as $2\frac{1}{2}$ in. per min., but averaged 1 in. per min.

The 6 plug drills and air compressor plant cost about \$2,000. About one ton of coal was used daily.

The Quarry Bar. A quarry bar is a long bar mounted on four legs, and upon the bar the drill is mounted, so that the drill can be moved quickly from hole to hole along the bar.

It is stated in the Ingersoll-Sergeant catalogue that in granite a "Baby" drill on a quarry bar will drill a hole 3 or 4 in. deep in $\frac{3}{4}$ min., and it can be moved and started in another hole in less than $\frac{3}{4}$ min., so that 100 ft. of hole are drilled in a day.

The quarry bar is a device that should be used far oftener than it is; for example, wherever vertical drill holes are spaced close together, as in shallow, open cuts, a long quarry bar may be preferable to a tripod, because of the time saved in setting up. In trench work a quarry bar might, in many cases, be used to advantage with the bar spanning the trench.

In the construction of the approaches to Sand Patch Tunnel (B. & O. R. R.), in stratified red sandstone, two $3\frac{1}{4}$ -in. Sullivan tappet valve drills were mounted on a quarry-bar. These machines with a crew of four men put in 200-ft. of 10-ft. holes, spaced 9 in. apart, in 10 hr.

The price of a quarry bar with carriage and weights is \$150 to \$200, and its weight is 950 to 1,700 lb. (See Fig. 120.)

Broach Channeling. In quarrying granite the quarry bar is used to some extent for broach channeling, which consists in drilling a row of holes close together like the holes in a postage stamp and then using a "broach," or chisel, to break down the rock between the holes. The wall left between the holes is $\frac{3}{4}$ to 2 in. thick, depending upon the hardness of the rock. The "broach" is, of course, not rotated like the ordinary drill bit. In the Ingersoll-Sergeant catalogue the following data are given as to average broach channeling work done per day by one drill on a quarry bar: In granite, 10 to 20 sq. ft.; in marble, 20 to 30; in limestone, 15 to 35; in sandstone, 20 to 40 sq. ft. See also page 574 for records in Vermont granite.

Where it is necessary to excavate igneous rocks, like granite or schist, close up to large buildings whose foundations must not be disturbed, broach channeling is often specified.

In this connection it is well to quote from *Engineering Record*, Feb. 7, 1903, a method of blasting close to a tall brick building without channeling. The rock excavation was 60 ft. deep, the rock being stratified in 1 to 4-ft. layers. A trench 10 ft. wide was taken out (10-ft. lifts) parallel with the building. Along the face of the building a row of holes was drilled 18 ft. deep, *holes being 6 to 8 in. center to center.* A second parallel row of holes was drilled 2 ft. away from the first row, the holes

being 2 ft. apart and loaded lightly with 40% dynamite. The holes in the row next to the building were not charged, but the blast caused the rock to crack along the line of these uncharged holes.

The Gadder. The Ingersoll gadder is a machine shown in Fig. 26. It is simply an ordinary rock drill mounted upon a block which can be raised or lowered on an upright post. The post is pivoted at its lower end to a heavy cast-iron bed plate mounted on wheels. The machine will drill holes in a horizontal line near the floor of the quarry, or in a vertical row, or in a line at any desired angle, for the post can be tilted at will. After drilling the holes, plugs and feathers are used to break off blocks as desired. Fig. 122 shows a channeler, and gadder. A drill is said to have a record of 350 ft. of holes in 10 hr. in marble, only 0.3 min. being required to move from one 2-ft. hole and begin drilling the next.

The weight of a gadder frame is about 2,600 lb., and the price is approximately \$465, not including the price of the drill

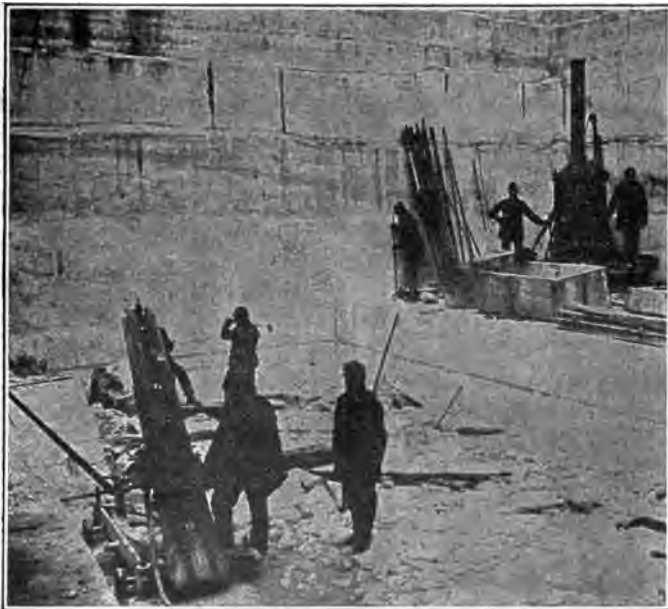

Fig. 122. Gadder in a Quarry and Channeler in Background.



Fig. 123. Simplex Channeler.

which is about \$165 extra. The weight of drill and frame complete is about 3,150 lb.

Channelers. In quarrying sandstones and marbles, channeling machines are largely used. In the first edition of this book, I predicted that channelers would often be used in rock excavation where it is desirable to have smooth sides. This prediction has been borne out and channelers have been used on most of the

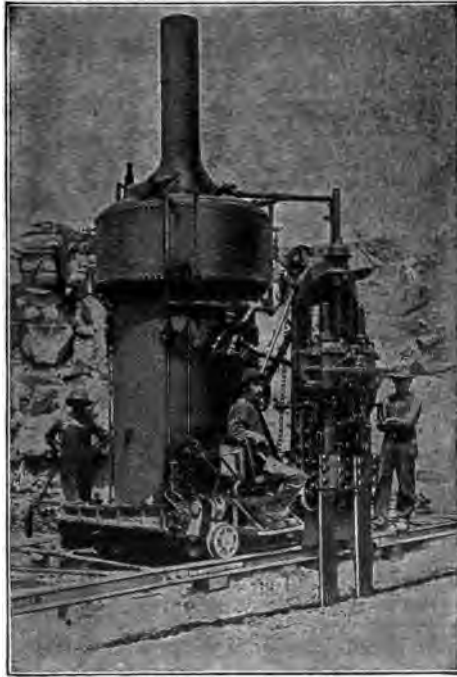

Fig. 124. Duplex Channeler.

important canal work and in subway building construction, city sewer trenches, etc., as well.

Channelers having one cylinder and one set of cutting bits are called "simplex."

Channelers having two sets of cutting bits are "duplex" or "double head."

A track channeler is a self-propelling machine that travels back and forth on a 10 to 30-ft. section of track having a gage

of 4 ft. 11 in. The channelers used on the Chicago Main Drainage Canal weighed about 11,000 lb. each. The stroke was 10 in., and about 250 blows were struck per min., the channeler moving forward a fraction of an inch at each blow. The gage of the cutting bit was $2\frac{3}{8}$ in. at the start, and decreased in



Fig. 125. Channeled Walls of Wheel Pit.

width by $\frac{1}{8}$ in. each 2 ft., as in drilling. The extreme depth of a lift was 14 ft. The channels cut were perfectly vertical.

Channelers are made that will cut up an angle of 45° (or even horizontally if special frames are provided) for use in quarries where the strata have a sharp dip. Channelers are also made to be mounted on quarry bars, the catalogues of makers showing a variety of types and sizes.

Fig. 125 shows a wheel pit extension, 21 ft. wide and 185 ft. deep, made with Sullivan channelers for the Cataract Construction Co. at Niagara Falls. It will be noticed that at each successive lift there is an offset or step of about 6 in., but

that by giving a slight batter to the wall in each lift the trench preserves the same width at the bottom as at the top.

Channelers have been used with success even in "swelling" rock on the New York Barge Canal and the lock at Sault Ste. Marie, Michigan. The expansion of the rock was such as to close the channel cuts almost as soon as they were made, but the difficulty was overcome by blasting out a center cut which relieved the side pressure.

As a rule, it does not pay to use track channelers for channeling granite, particularly in quarry work, since broach channeling is cheaper. However, conditions may be such that even in hard compact rocks channeling is economical. In excavating for two walls, each 500 ft. long and 15 ft. deep, under the terminal yards of the New York Central R. R. in New York City, in 1906, drilling and broaching cost 52 ct. per sq. ft., whereas channeling cost 16.7 ct. The rock was gneiss and mica-schist.

For quarrying large dimension stones (granite excepted) the channeler has become an economic necessity. Its first cost should not prevent its purchase, once the quarry has been opened sufficiently to prove the marketability of the stone. A channeler will quickly save its cost in the better price received for the stone and in the saving on freight. The last item is one often overlooked, but it may be said, roughly speaking, that fully 20% of the stone quarried without channeling is lost in the subsequent cutting and dressing after reaching its destination. Since rough dimension stone is paid for by its neat measurement, it is evident that in the end the quarryman must foot the bill for this waste and the freight upon it. The actual cost of channeling when computed in cents per cubic foot of stone is really slight; for the stone is not cut up with the channeler into merchantable blocks, like harvesting ice, but a series of parallel channels are cut across the quarry so as to loosen blocks of stone which may be 50 ft. or more in length. These long blocks are then split with plug and feathers into sizes that the derricks can handle. The smaller blocks are then either sawed up, or still further reduced in size by plug and feathering.

It must be remembered that in quarrying, the stone is channeled on two sides, and sometimes on four, or even on all six, sides. In building-stone quarries when the floors are channeled two ways, one square foot of channeling usually frees $3\frac{1}{4}$ cu. ft. of stone. When channeling is done under the block of stone as well as on four sides of it, about $2\frac{1}{2}$ cu. ft. are liberated per sq. ft. of channeling, and in covered quarries, where the rock lies at an angle of 45° , one square foot frees about $1\frac{1}{4}$ cu. ft. of stone.

Sizes of Channelers. Tables LXII and LXIII give the specifications of channelers.

TABLE LXII. SULLIVAN CHANNELERS

Class.	Type.	Diameter of cylin-der, inches.	Feed or depth cut without changing steel, inches.	Height of machine above rail.*	Length along track.	Greatest width.		Track gauge, in. side ranges.	Center of cut to wall.	Distance, center to center of cuts when machine is turned on track.	Greatest angle from vertical, deg. stand'd can be set.	Machine alone.	Equipment alone (no steel).	Total.
						Ft. In.	Ft. In.							
VS21	Single Swivel, without boiler °	7	18	8 9	6 5	6 6%	4 11	7	6 8	6 8	16	8050	4930	12980
VS31	Single Swivel, with boiler †	7	18	10 4	6 9	7 9%	4 11	7	6 8	6 8	16	12850	5130	17980
VS41	Single Swivel, without boiler °	8	24	8 8%	6 5	6 7%	4 11	8	6 8	6 8	16	8400	5158	13558
VS51	Single Swivel, with boiler †	8	24	10 4	6 9	7 10%	4 11	8	6 8	6 8	16	13200	5358	18558
VS71	Single Swivel, wide frame, with boiler ‡	8	24	10 4	6 9	8 5%	6 9%	8	6 8	6 8	16	13800	5358	19158
VD1	Double Swivel, without boiler ¶	6½	18	6 8	6 5	6 5%	4 11	6	6 6	6 6	133	7700	5036	12736
VD11	Double Swivel, with boiler ¶	6½	18	10 4	6 9	7 8%	4 11	6	6 6	6 6	16	12500	5236	17736
VD21	Double Swivel, without boiler °	7	18	8 9	6 5	6 6%	4 11	7	6 6	6 8	16	8050	4970	13020
VD31	Double Swivel, with boiler †	7	18	10 4	6 9	7 9%	4 11	7	6 6	6 8	16	12850	5170	18020
VD51	Double Swivel, without boiler °	8	24	8 8%	6 5	6 7%	4 11	8	6 8	6 8	16	8400	5174	13574
VW1	Duplex, without boiler ¶	6½	18	6 10	6 5	6 7%	4 11	8	6 6	6 6	16	14300	5081	19381
VW11	Duplex, with boiler ¶	6½	18	10 4	6 9	7 10%	4 11	8	6 6	6 6	16	14300	5281	19681
VW21	Duplex, wide frame, with boiler ¶	6½	18	10 4	6 9	8 5%	6 9%	8	8 4	8 4	16	14900	5281	20181
VW31	Duplex, without boiler ¶	7	18 or 36	6 10	6 5	6 8%	4 11	8	6 8	6 8	16	11000	4910	16010
VW51	Duplex, wide frame, with boiler †	7	18 or 36	10 4	6 9	8 6%	6 9%	8	8 6	8 6	16	16500	5110	21610
VW61	Duplex, wide frame, with boiler ‡	8	36	13 1½	6 9	18 9%	6 9%	11	8 6	8 6	16	24450	5106	29556
VX21	Double Swivel, no boiler §	4½	18	6 1	4 3	4 6%	3 3	5%			140	2950	2184	5134
VX31	Double Swivel, undercutter §	4½	18	2 0	variable	variable	3 3	5%			140	2950	2384	5334

* Boiler machines are measured to the top of the smoke bonnet, without the stack; machines without boilers, to the top of the standard when vertical.
 † 9 ft. 8½ in. with hose winding drum.
 ‡ All angles less than this require special braces.
 § Have hand hoist and feed.
 ¶ Can be fitted with air reheater instead of boiler. If so desired, add "re" to regular code word.
 § Steady weights for frame can be furnished if needed; total weight of three equals weight of boiler with water.

QUARRYING DIMENSION STONE

TABLE LXIII. SPECIFICATIONS OF INGERSOLL-SERGEANT CHANNELERS

Size and type.	Fixed Back Channeler. "Hy."	Swing Back Channeler. "Hy."	6 in. Channeler.	5 in. Channeler.	Broncho Channeler.
Diameter of cylinder	8 in.	7	6	5	3½
Length of stroke	9 in.	9	6½	6½	7
Distance of cut from vertical wall	7½ in.	7½	7¾	5	8½ (lift)
Distance of cut from center of cut with machine reversed	ft. in.	6-0%	4-7%	4-6%	4-0%
Inside gage of track	ft. in.	4-4%	3-0%	3-0%	4-0%
Length over all	ft. in.	5-3	5-5	5-5	5-10%
Width over all	{ Without boiler	7-1	7-0½	5-5	5-2
	{ With boiler	7-6½	7-0	5-5	8-3
	{ With reheater	7-3½	7-3	7-10	2-6
Height	{ Without boiler	7-4	7-2	6-10%	6-0
	{ With boiler	10-0	10-0	10-2	
	{ With reheater	7-4	7-4	7-2	
Weight of Channeler alone	{ Without boiler	9,000 lbs.	9,000	5,150	4,850
	{ With boiler	12,900 lbs.	12,900	6,800	2,375
Total shipping weight with track and equipment.	{ Without boiler	10,300 lbs.	10,300	6,800	2,375
	{ With boiler	13,900 lbs.	13,900	11,800	3,500
	{ With boiler	17,875 lbs.	17,875	11,800	3,500
	{ With reheater	15,175 lbs.	15,175	11,800	3,500

* Height is from top of rail to top of boiler hood which does not include stack.
 † These weights are for domestic shipment. Add 1,000 lbs. for foreign shipment.
 ‡ This weight is for domestic shipment. Add 200 lbs. for foreign shipment.

Power Required for Channelers. When operated by compressed air, manufacturers state that the number of cubic feet of free air consumed per minute of actual cutting is about as follows for single cylinder (simplex) channelers:

Diam. of Cylinder, in.	Free Air per min., cu. ft.
4½	190
6½	230
7	300
8	400

A duplex channeler taxes a little less (5 to 8%) than twice as much air as a simplex.

A reheater reduces these figures of air consumption about 20%. When a steam boiler is used a 25 to 30 hp. boiler serves a channeler having a 6½ to 7 in. cylinder.

Cost of Channeling. For cost data see Chapter XVI on Canals.

Prices of Channeling Machines. The approximate prices of Ingersoll-Sergeant channelers are as follows: Fixed back H-S, with boiler, \$2,900; without boiler, \$2,500; with air reheater, \$2,600. H-9, with boiler, \$2,700; without boiler, \$2,300; with reheater, \$2,400. Swing back channeler with boiler, \$2,365; without boiler, \$2,090; with reheater, \$2,390. Undercutting channeler, from \$1,200 to \$1,560. Broncho channeler, \$1,200.

Electric Air Channelers. These machines are operated in accordance with the same general principles as are the electric air drills heretofore described. The price of a machine complete is about \$4,250.

Depth of Cut. Rigid back or standard channelers will cut to a depth of 10 to 16 ft. Swing back and broncho channelers will cut 6 to 12 ft. Undercutting machines will cut to depths of 7 ft. The length of feed ranges from 18 to 36 in.

Bits. In marble and soft stone a gang of five bits is usual. In slate and gritty stone, a gang of three bits is common, while for rough broken rock a solid Z bit is used. The following facts relating to bits have been abstracted from the Sullivan catalogue.

The steels or gangs furnished with channeling machines vary in accordance with the work to be performed. In marble and in soft stone the gangs ordinarily supplied have five steels or members, all being securely held in the cross-head. Fig. 126A shows the manner of sharpening for marble or other stones, either hard or soft, which chip freely. It will be noticed that the center and the two outside members of the gang are at right angles to the cut, the alternate steels or diagonals being sloped at an angle of 45 deg. in the same direction; that is, parallel.

Fig. 126B shows the gang recommended for either hard or soft stones which are tough or do not chip freely, such as cer-

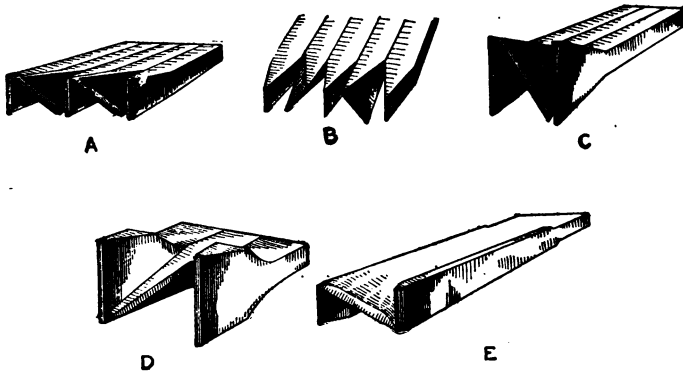

Fig. 126. Steels for Channeler Bits.

tain kinds of limestone and sandstone. This is like the marble gang, except that the diagonals slope toward each other instead of being parallel, forming a V with each other.

Fig. 126C shows the form of gang customarily used in quarrying slate. This consists of three pieces only, the two outside being parallel with each other and at right angles with the cut, the center steel being sharpened at an angle, making the whole gang take the shape of the letter "Z." In quarrying slate when difficulty is experienced in keeping the end of the cut square—that is, in preventing the cut from tapering off and leaving a slope instead of going down straight next to the head end or wall—the wide members of the gang are sharpened so that they present a flatter surface to the ends of the cuts.

Fig. 126D shows another type of three-piece gang used with the larger channelers, mainly in contract work, but sometimes also in quarry work. It is especially suited for sharp or gritty stones, such as wear the gage of the gang rapidly. It will be seen that this steel is heavily up-set in a direction at right angles to the length of the cut, and this wide bearing gives the added wearing surface necessary to secure rapid channeling and to maintain the gage of the cut.

The solid steel known as the "Z" bit, shown in Fig. 126E, is especially designed for work in rough, broken rock, and for particularly deep cuts. These are the conditions found chiefly in contract work, and it is in this class of work that the "Z" bit is used almost altogether.

The solid bit is much more satisfactory for broken and "wild" rock than a gang of steel would be, as it is better able to resist the uneven strains met in channeling under the conditions mentioned.

TABLE LXIV. SPECIFICATIONS OF CHANNELING MACHINE STEELS (SULLIVAN)

Size of Machine	Kind of Work	Length of Run or Distance Drilled Without Changing Steel In.	Kind of Gang	Two Gangs Each of Following Lengths ft.	Regular Equipment Each of Following Lengths in.	Dimensions of Steel, In.
Y-8	Usual Quarry and Contract Work, Hard Limestone	18	3-piece gang	2	10	First two gangs,
Y			5-piece gang	4	4	1 x 2½
Z			5-piece gang	7	4	1 x 1½
Y-8	N. Y. Sandstones, Marble, Hard Sandstone	18	5-piece gang	4	4	Each piece
Y			5-piece gang	5	10	1 x 1½
Z			5-piece gang	7	4	
Y-8	Soft Limestone	24	3-piece gang	3	4	Each piece
Y			5-piece gang	5	4	1 x 2½
Y			5-piece gang	7	4	Each piece 1 x 1½
Y-8	Broken Rock Contract Work	18	Z	2	10	
Y			Solid	4	4	
Z			Solid	5	10	1 x 6
Y	Ohio Sandstone	18	3-piece gang	2	10	Each piece
Y-8			3-piece gang	4	4	1 x 2½
Y-8			3-piece gang	7	4	
6½ VW	Limestone, Slate, Marble and Soapstone	18	5-piece gang	2	10	Five pieces
			5-piece gang	4	4	1 x 2½
			5-piece gang	7	4	1 x 1½
VX	Work of all Classes	18	3-piece gang	2	6	Each piece
			3-piece gang	4	0	1 x 1½
			3-piece gang	5	6	
				7	0	
				8	6	
				10	0	

In channeling shale containing frequent "nigger heads," 86 channeler bits were used in 22 days to channel 3,779 sq. ft., or 44 sq. ft. per bit.

Rate of Cutting with Channelers. The following data are given in the Ingersoll-Sergeant catalogue as being conservative estimates based upon actual monthly averages. The number of square feet channeled by the 6 and 7 in. machines per day: 75 sq. ft. of hard brownstone or sandstone; 75 to 150 sq. ft. of marble; 200 sq. ft. of soft Lake Superior brownstone; 250 sq. ft. of soft oölitic limestone. The actual averages on the Chicago Drainage Canal work are given in Chapter XVI, where also are given reliable data of cost.

The Ingersoll-Sergeant catalogue states that 700 sq. ft. of "völtic" limestone have been channeled in 10 hr., and that in Ohio sandstone of medium hardness, 260 to 300 sq. ft. are averaged per day of 10 hr. with a bar channeler.

The "Broncho" channeler is mounted on two parallel bars, somewhat similar to a quarry bar, along which it is moved automatically. The engine is automatically reversed at any desired point, causing the carriage to move back and forth. An attachment permits the machine to be used in drilling a round hole in any position from vertical to horizontal. The catalogue states that this machine will channel 40 sq. ft. in hard marble and limestone and 80 to 120 sq. ft. in softer marble per day of 10 hr. In ordinary sandstone it will channel 75 to 125 sq. ft., in slate 60 to 120 sq. ft., and in "völtic" limestone 125 to 200 sq. ft.

The rate of cutting with channelers varies greatly with the machine and the rock. Table LXV gives the rate of channeling with simplex channelers, as given in Sullivan bulletins.

Some Records of Channeling, Drilling and Cableway Work.

In work on the West Neebish channel, in the improvement of the St. Mary's River between Lake Superior and Lake Huron, the excavation was in hard compact Niagara limestone, weighing 4,600 lb. per cu. yd. The total amount of rock excavated was 1,700,000 cu. yd. The depth of the cut varied from zero at the ends to 27 ft. in the center, with an average depth of 15 or 16 ft. The cut was 8,800 ft. long.

In order to make the sides of the cut smooth, channelers were used, there being one Sullivan Class "V" 7-in. channeler, which carried its own boiler and two 8-in. air channelers, made by the Ingersoll-Rand Co. More than 200,000 sq. ft. of wall were channeled. An average day's run for the machine was from 75 to 100 sq. ft., although on test runs, as much as 205 sq. ft. were cut by one machine. These machines were capable of cutting to a

TABLE LXV. RATE OF CUTTING WITH SULLIVAN CHANNELERS

Location	Rock	Diam. of cy- linder, in.	Sq. ft.	Time
<i>Quarry Work:</i>				
Philipsburg, Que.	Marble	6 1/2	63	10 hr.
West Rutland, Vt.	Marble	6 1/2	219	Best 10 hr. day
West Rutland, Vt.	Marble	6 1/2	2500	Av. mo. (250 hr.)
Tennessee	Marble	6 1/2	80	Av. day, season
Tennessee	Marble	6 1/2	140	Best day
Georgia	Marble	6 1/2	150	Av. day
Brandon, Vt.	Hard marble	6 1/2	1485	Av. mo. for 12 mo.
Brandon, Vt.	Hard marble	7	1677	Av. mo. for 12 mo.
Bloomington, Ill.	Limestone	7	6000	10 days
Batesville, Ark.	Hard limestone	7	130	Av. day
Carthage, Mo.	Hard limestone	7	135	Av. day
Amherst, O.	Sandstone	7	225	Day
Florida Keys	Coral rock	7	750	Av. 10 hr.
Pennsylvania	Slate	4 1/2	60	Av. day
Vermont	Slate	4 1/2	75	Av. day
Virginia	Soft soapstone	4 1/2	200	Av. day
Virginia	Soft soapstone	6 1/2	260	Av. day
<i>Contract Work:</i>				
Lockport, Ill.	Limestone	7	210	Av. 10 hr.
Lockport, Ill.	Limestone	7	382	Best 10 hr.
Sault Ste. Marie	Hard limestone	7	75-100	Av. day
Keokuk	Hard limestone	7	80	10 hr.
Sault Ste. Marie	Sandstone	7	70-80	8 hr.
Sault Ste. Marie	Tough sandstone	7	60-75	8 hr.
Sault Ste. Marie	Tough sandstone	7	150	Best 8 hr.
New York City	Gneiss	8	60-75	8 hr.
Panama Canal	Medium broken rock	8	120	8 hr.

Duplex channelers have about 50% greater daily output than simplex machines of equal cylinder size.

depth of 14 ft., but in most of the work done, the cut was put down in two lifts.

The cut was 300 ft. wide, and in blasting 150 ft. of the breast was shot at one time, allowing the steam shovels to work on one-half the cut, while the drills were at work on the other half. About thirty 3 1/4-in. rock drills were used. The holes put down were from 12 to 16 ft. deep. The holes were spaced in 4 x 6 ft., or 5 x 5 ft. squares. This close spacing was found necessary on account of the hardness and dense nature of the rock. The average work done by a drill per shift, both summer and winter, was from 40 to 60 ft., say 50 ft. Air hammer drills were used to drill top holes for breaking up large boulders. The drill holes were shot with dynamite, 3/4 lb. (half 60% and half 40%) being used for each cubic yard of rock blasted.

Four 60-ton steam shovels, mounted on traction wheels with 30-in. tires, were used to load the muck into skips that were handled by four cableways, two having spans 1,100 ft. and two spans of 800 ft. each. The skips held 6 cu. yd. each, but loads as high as 18 tons, consisting of boulders of 7 or 8 cu. yd., were *handled* by the cableways. An aerial dumping device was used

on the cableways. One of these cableways handled 30,000 cu. yd. in a month, which was the best month's record for any single cableway. The best month's record for the four cableways was 88,000 cu. yd. of rock, or an average of 22,000 cu. yd. per cableway.

Test of Channeling Machines in Limestone. Mr. C. H. Levey (*Mine and Quarry*, Jan., 1913) gives the following data concerning the results of a 9 day channeling test in a limestone quarry in the Indiana "voltic" district with two types of machines. The "VW61" (see Table LXII), 8-in. duplex, Sullivan machine had two chopping engines and two gangs of steel side by side, and was operated by steam, at 140 lb. pressure, from its boiler. The machine runs on a track of 6-ft. 9-in. gage, and may be turned around on a turntable especially devised as a part of its track equipment. The operation of turning is performed by its crew of 3 men in 15 to 18 min. It can make two cuts 8½ ft. apart. The feed is 36-in., but the starters cut only 12 or 14 in. in order to secure stiffness in the gangs of steel. The pistons strike alternately, so that one set of steels travels up while the other travels downward, which reduces vibration and jar. The two gangs of bits mix the sludge better than one and this is particularly important in channeling "blind" cuts or those without an open end permitting the sludge to escape. The track speed of the machine was about 34 ft. per min.

The "Y7" (Table LXII) channelers were single gang, direct acting, steam channelers with vertical boilers and 7-in. engines. Quarry conditions for both types of machines were similar. The cuts were 14-ft. long.

Type of machine.	Duplex VW61	Simplex Y7
Average cut per day, sq. ft.	670	283
Average cut per hour, sq. ft.	72.2	30.5
Average cut per hour of actual running time, sq. ft.	140	46
Average days' time, hr.	9.27	9.27
Average exceptional delays per day, hr.	1.04	
Average running time per day, hr.	4.78	6.15

Cost of Derricks. In dimension stone quarries very large guy derricks are used, so that it is possible to handle blocks of stone weighing 20 tons. The following paragraph gives the cost of one of these huge derricks:

Saunders gives the following cost data in the magazine, *Stone* (New York), 1890, p. 95: A large quarry derrick capable of lifting 20 tons with a single line, having a 24 x 24-in. mast, 75 ft. high, and a 65-ft. boom actually cost as follows:

Timber for mast	\$ 45.00
Timber for boom	28.00
Expense of delivering timber	16.50
Carpenter work on mast and boom at \$2.50 a day	25.00
Complete set of derrick irons, sheaves, etc.	228.00

2,400 ft. best galv. 1-in. iron rope for 8 guys	\$237.00
Thimbles, clamps, etc.	25.00
500 ft. steel hoisting rope, 1 1/2 in.	240.00
Labor on dead men, 4 men, 2 days at \$1.40	11.20
Labor raising derrick, 8 men, 2 days, at \$1.40	22.40
Labor fixing guys, 8 men, 2 days, at \$1.40	22.40
Total	\$891.50

Knox System of Blasting. In *Trans. Am. Soc. C. E.*, 1891, Mr. William L. Saunders describes the Knox system of blasting,

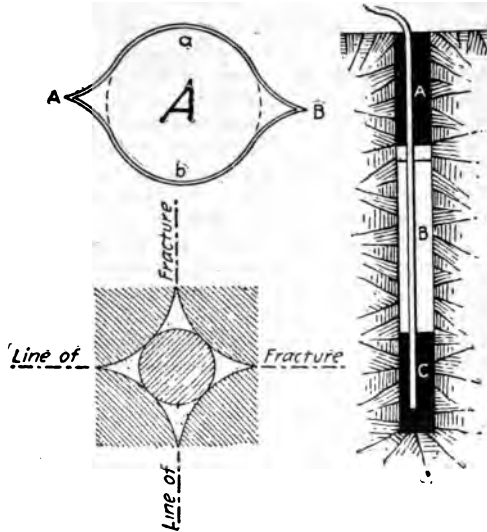

Fig. 127A and B.

Fig. 127C.

Knox Blasting.

named after the inventor. The patents have expired. The system consists in drilling a number of ordinary round holes in a row and then using a reaming tool to give the hole the shape shown by the heavy lines in Fig. 127A. The reaming is done by hand. In medium sandstone the holes may be 10 to 15 ft. apart, but in limestone I find that they are often placed as close together as 4 ft. The holes are charged with black powder, or with Judson powder, as shown in Fig. 127C, a wad of hay being put in so as to make an air space between the powder and the tamping.

The blast causes the rock to split in a straight line in the direction of the pointed or wedge-shaped sides of the hole. For *block-holing*, where it is desired to split a block into just four pieces, a single hole is reamed as shown in Fig. 127B.

Saunders gives the following data: At Portland, Conn., 15 Knox holes in brown sandstone, charged with 2 lb. of black powder (No. C) in each hole, loosened a block of rock 110 ft. long, 20 ft. wide and 11 ft. thick, weighing 2,400 tons. This block was split off and moved out 2 in. *en masse*. Another sandstone ledge, open face and ends, was blasted with 1 lb. of powder in each of 25 holes, and a block 200 ft. long, 28 ft. wide and 15 ft. deep was broken off and moved $\frac{1}{2}$ in. At the mica schist quarries at Conshohocken, Pa., a blast of $\frac{1}{2}$ lb. of powder in a single hole broke a block 27 ft. long, 15 ft. wide and 6 ft. thick across the rift.

See page 574 for description of Knox blasting in Vermont granite.

Cost of Quarrying for the Buffalo Breakwater. In *Engineering News*, May 16, 1901, Mr. Emile Low (in an article on the Buffalo breakwater) gives data on quarrying by the Knox system. The contractors, Hughes Bros. & Bangs, signed their contract Jan. 27, 1897, at the following prices: Gravel hearting, 13 ct. per cu. yd.; rubble stone, 80 ct. per ton of 2,000 lb.; capping stone and revetment, \$1.25 per ton. No work was done in the winter. Water telescopes were used in placing the revetment. Of revetment, 235 tons were placed daily, the stone weighing $6\frac{2}{3}$ tons each on an average, and up to a maximum of 17 tons. All scows were provided with glass gages and graduated rules for weighing the stone. A gage is made of 3-in. wrought iron standpipe, into which two brass cocks are screwed. Between the cocks, which are $4\frac{1}{2}$ to 7 ft. apart, depending on the draft of the scow, is placed a 1-in. glass tube; and a wooden rule graduated to hundredths of a foot is attached alongside. Lockport limestone weighting 165 lb. per cu. ft. solid, and Medina sandstone weighing 152 lb. per cu. ft. solid were used for small rubble. The voids in the broken stone were 50%.

Most of the stone used was a limestone, quarried near Windmill Point, Ontario, and weighed 166 lb. per cu. ft. The stone was taken out in four ledges; the first, 20 to 36 in. thick; the second, 6 to 9 ft.; the third, 7 to 10 ft.; the fourth, 5 ft. In opening the quarry a trench 30 ft. deep x 100 ft. wide was made as rapidly as possible, using heavy charges of dynamite. In quarrying the face was worked in four ledges. The top ledge was drilled with holes 18 ft. back from the face and 4 ft. apart, the holes going down to within 6 in. of the bottom of the ledge. An attempt was made to start and end at a joint, so the ledge could be moved entire for 200 ft. or so.

Three sizes of Ingersoll-Sergeant percussive steam drills were used: A ($2\frac{1}{4}$ in.); C ($2\frac{3}{4}$ in.), and F ($3\frac{1}{2}$ in.). At a depth of 18 ft. the hole was $1\frac{3}{4}$ in. diam., losing $\frac{1}{4}$ -in. every 3 ft.

After the holes were drilled they were reamed to an elliptical shape (Knox hole) by a diamond-shaped tool driven either by hand or by steam. Black powder was charged, 3 or 4 handfuls in each hole first; then the exploder, then a little more powder; then a wad of grass was forced down leaving 2 or 3 in. of air above the charge; then a clay tamping to the top of the hole. Dry sand is sometimes used instead of clay, being more quickly placed, and giving good results. Sand is also easier to clean out in case of misfire. To clean out a misfire hole, a steam hose is attached to small pipe through which steam and water are blown as the pipe descends, thus blowing out the charge.

One block of stone, 180 ft. long, 18 ft. wide and 9 ft. thick, weighing 2,430 tons, was blasted off by one firing, requiring 52 holes, 8 to 9 ft. deep, 18 ft. from the face and $3\frac{1}{2}$ ft. apart, loaded with 75 lb. of black powder. These 52 holes were loaded and tamped with sand in 1 hr., where it would have taken $2\frac{1}{2}$ to 3 hrs. with clay. The block (1,080 cu. yd.), was moved 2 ft. by the 75 lb. of powder, that is, 1 lb. of powder loosened 14 cu. yd. of solid rock.

Another (3,375-ton) block 250 ft. long, 9 ft. thick and 18 ft. wide, was thrown out (2 to 3 ft.) with 150 lb. of powder in 62 holes.

After these large blocks were separated from the ledge, they were split up by drilling holes and using either plug and feathers or light powder charges.

The plant consisted of: 2 A, 9 C and 3 F drills; 8 derricks in the quarry and 1 at the loading dock; 4 50-hp. boilers for derricks; 4 skeleton 20-hp. ($8\frac{1}{4}$ x 12-in.) hoisting engines for 8 quarry derricks; 1 hoist and boiler for hauling cars up incline; 1 boiler for 2 steam pumps for draining quarry; 1 dinky locomotive; 50 cars, 3-ft. gauge; 68 skips, holding 3 to 4 tons, for carrying stone on flat cars; blacksmith shop and 5 forges; machine shop; track, etc.

The force during June, 1903, was as follows:

General:		Total per 10 hr. day.
1 superintendent	\$167.00 per mo.	\$ 7.00
1 time keeper	60.00 per mo.	2.25
1 general foreman	85.00 per mo.	3.25
Stripping gang:		
1 foreman	2.25	2.25
4 laborers	1.50	6.00
1 team	3.00	3.00
Quarry:		
1 assistant general foreman	3.00	3.00
8 foremen (one per derrick)	2.25	18.00
14 machine drillers	2.00	28.00
14 machine drillers' helpers	1.50	21.00
4 hoist engineers (derricks)	1.75	7.00
1 hoist engineer (inclined plane)	1.75	1.75

QUARRYING DIMENSION STONE

565

		Total per 10 hr. day.
<i>Quarry, continued.</i>		
5 firemen	\$1.75	\$ 8.75
50 laborers	1.50	75.00
1 water boy	1.00	1.00
1 watchman	1.75	1.75
1 team	3.00	3.00
<i>Loading dock:</i>		
1 foreman	2.25	2.25
1 hoist engineer	1.75	1.75
1 fireman	1.75	1.75
6 laborers	1.50	9.00
1 watchman	1.75	1.75
<i>Track repairs:</i>		
1 foreman	2.25	2.25
3 laborers	1.50	4.50
<i>Blacksmith shop:</i>		
1 foreman	3.00	3.00
3 blacksmiths	2.50	7.50
3 helpers	1.75	5.25
<i>Others:</i>		
1 locomotive driver	2.50	2.50
1 machinist	75.00 per mo.	3.00
2 carpenters	1.75	3.50
Total		\$240.00

TABLE LXVI.
Quarrying Data

Month, 1903.	Stone quarried, tons of 2,000 lb.			Cost of Labor only.	Cost per Ton, ct.
	Rubble.	Capping.	Total.		
May	16,535.9	16,535.9	\$ 5,127.51	31
June	12,771.2	2,541.4	15,312.6	5,154.65	34
July	11,444.4	5,273.8	16,718.2	5,438.91	33
Aug.	9,426.2	5,118.7	14,544.9	5,071.92	35
Sept.	5,937.0	2,931.9	8,868.9	3,283.85	37
Total	56,114.7	15,865.8	71,980.5	\$24,076.84	33

Month, 1903.	Days worked.	No. of holes drilled.				Lin. ft. drilled.				Explosives, lbs.		
		A	C	F	Total.	A	C	F	Total.	Powder.	Dynamite.	Coal, tons.
May	24½	513	896	556	1,965	1,385	4,757	4,840	10,982	1,691	302	211
July	24½	674	2,101	674	3,449	1,177	10,771	4,927	16,875	2,683	292	226
Aug.	23.7	620	1,978	638	3,256	853	10,098	4,677	15,628	2,558	117	236

Month, 1903.	No. holes per day per drill.			Lin. ft. of hole per day per drill.			Average depth of holes.		
	A	C	F	A	C	F	A	C	F
May	12.5	10.0	8.8	33.8	53.4	76.2	2.7	5.3	8.7
July	13.8	9.5	9.5	24.0	49.0	67.0	1.7	5.1	7.3
Aug.	13.3	9.4	9.4	18.4	47.3	65.8	1.3	5.1	7.1

About 1 lb. of black powder was used for every 7 tons of stone quarried, and 1 lb. of dynamite for every 67 tons, and 1 ft. fuse for every 5½ tons of stone.

The cost of powder, dynamite and fuses per ton of stone was: In May, 1.3 ct.; July, 2.0 ct.; August, 2.1 ct.

The total cost of quarrying stone, loading and placing on scows was as follows:

	Cost per Ton, ct.	Cost per cu. yd., ct.
Labor	33	74.3
Coal	4	9.0
Explosives	2	4.5
Miscellaneous	5	11.2
Total	44	99.0

Methods of Quarrying Marble. The methods pursued in quarries where the rock lies in horizontal or slightly dipping layers is illustrated in Fig. 128, from the Sullivan catalogue. The

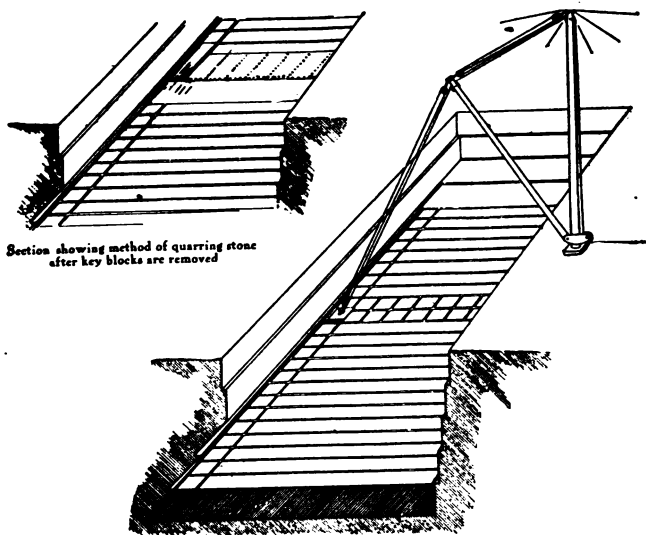

Fig. 128. Open Marble Quarry.

working floor, after being cleared of the overburden and worthless cap rock, is channeled into strips, the cuts being usually about 6-ft. deep. Cross channels are then run at right angles. A "key" block is then split off by wedges and removed with a derrick as illustrated. Plug and feather holes are then driven beneath the adjoining key block and this is split from its bed. When the row of key blocks has been removed, the floor thus formed is again similarly worked on as shown in Fig. 128.

Where the rock dips at a very sharp pitch it is necessary to operate a tunnel or covered quarry. This method is illustrated

in Figs. 129 to 131. Figs. 131 A and B show the order of driving a tunnel heading, the lower hole being shot first, then the center and finally the roof holes. When the new bench is opened up, channelers are put to work again.

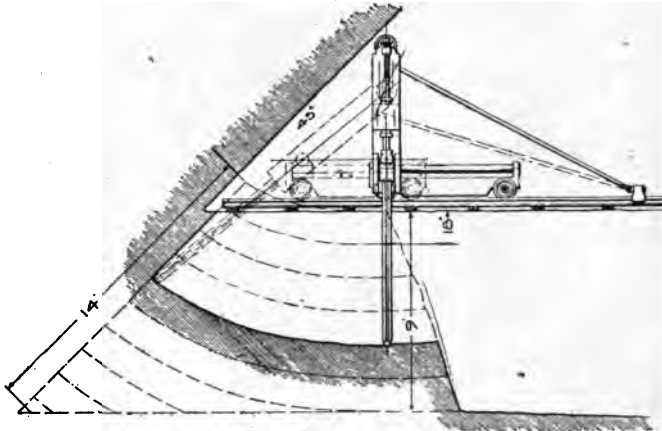

Fig. 129. Channeling into a 45 deg. Tunnel Cut. The Dotted Lines Show Position when Cutting up to the Wall.

Quarrying Marble at Phenix, Missouri. Mr. B. B. Brewster (*Mine and Quarry*, Jan., 1914), gives the following data concerning the methods of quarrying in use in the marble territory in Greene County, Missouri. The limestone at Phenix is white, with a slight grayish tint. It is hard and highly crystalline, of a close, even texture, being what is geologically known as a Burlington limestone.

The ledges are horizontal and from 7 to 13 ft. thick, the thickness increasing with the depth of the deposit. The beds are interspersed by occasional mud seams, which in some instances have been washed out, leaving caves. Beds of flint nodules occur occasionally in the formation, but do not occasion large waste, as the stone is usually quarried along them.

The only limit as to the size of mill blocks, of which large quantities are shipped, is the capacity of freight cars. Under the present system of quarry operation, the standard mill block is 10 ft. long, 4 ft. wide and 5 ft. high, although practically any length and height on natural beds can be secured, if ordered in advance.

The company operates two quarries, "A" and "B" respectively, at Phenix. The "A" quarry has a working face 350

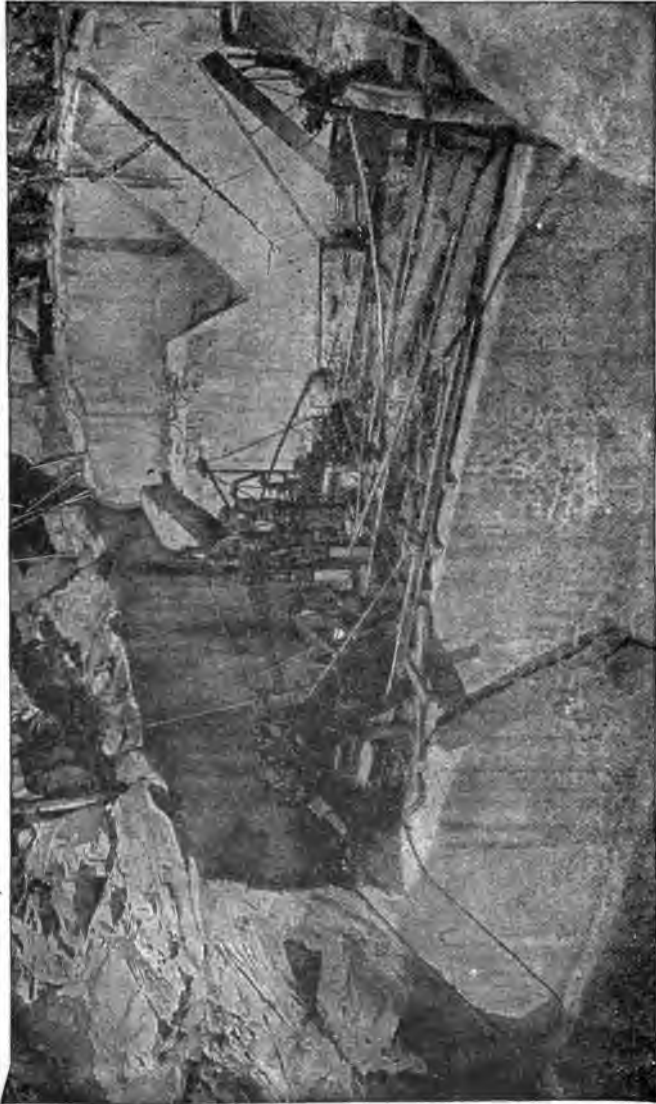

Fig. 130. Opening a Vermont Quarry. Sullivan Corner Cutter at Left, Duplex Channeler in rear.

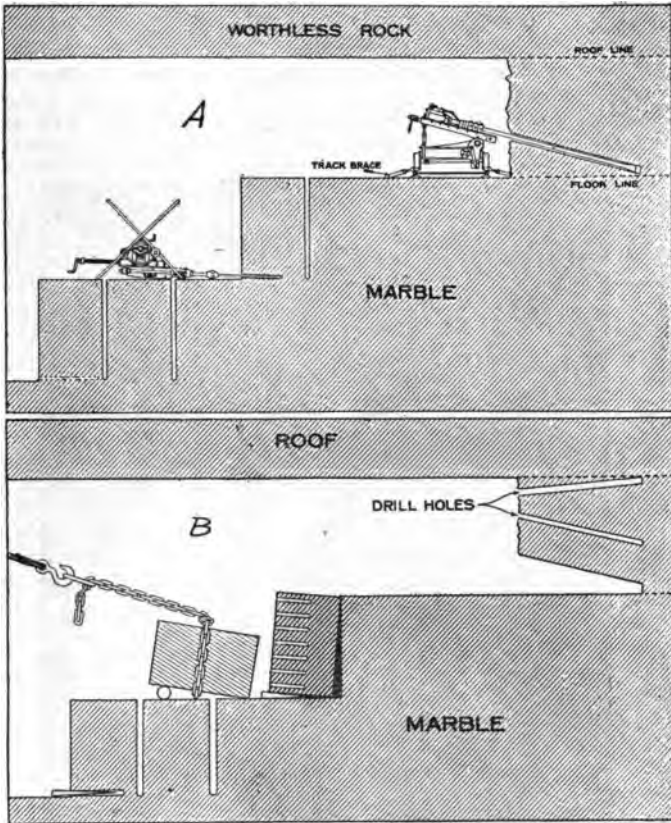

Fig. 131A and B. Quarrying Marble by the Tunnel Method.

ft. long. The method of quarrying is that customary throughout this field, as well as in the Bloomington-Bedford Oolitic limestone district in Indiana; namely, the light overburden, consisting of a few feet of soil and rough cap rock or "cotton" rock, as it is called locally, is first stripped, exposing the regular beds of good stone below. Track channeling machines are then put to work to cut the floor into blocks. At the "A" quarry channels are cut lengthwise of the face at intervals of 5 ft., and

to a depth varying with the thickness of the bed, frequently ranging from 8 to 13 ft. Every 23 ft. headlines, or cross channels, are carried. As the channels usually run to a bed-plane or mud-seam, no drilling and wedging is required to free the blocks at the foot. They are turned over by driving wedges into the cut and by pulling the top of the block over with the quarry derrick and tackle.

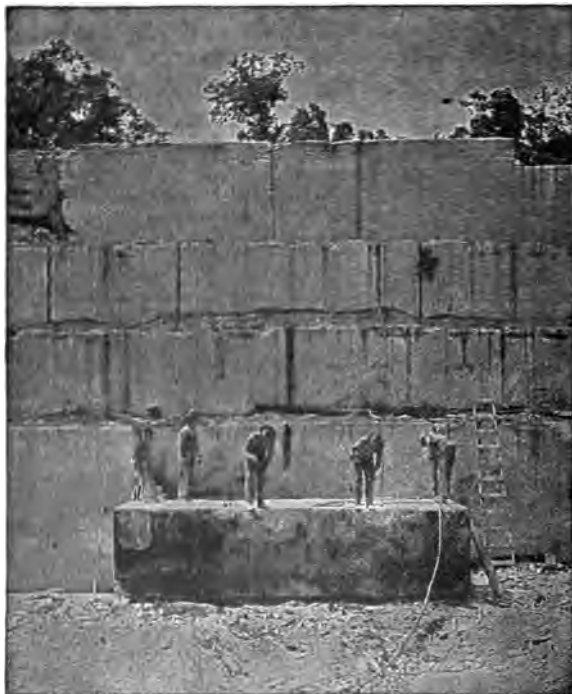

Fig. 132. Marble Block 23 x 13 x 5 ft. Cut by Channelers.

Fig. 132 shows one of these blocks turned over and ready for splitting. This gives a block 23 x 10 x 5 ft. in size, which is quartered to make four mill blocks, 10 x 5 x 5 ft., weighing approximately 25 tons each. Thus each square foot of channel gives 3.2 cu. ft. of stone.

Approximately 150,000 sq. ft. of channel are cut in a year, with the four Sullivan "Y-7" (7-in. cylinder) track channelers, which this company owns. The quarries work practically the

entire year, giving a channeling average per machine per day of about 85 sq. ft., allowing for all delays and lost time.

The channelers are of the familiar single-gang, direct-acting, steam-driven pattern, which are used almost exclusively in the Missouri building stone districts, and which have practically replaced earlier types, used some 8 or 10 years ago. They carry vertical boilers and employ the regular five-piece gang or bit, the two outside and the center members of the gang being sharpened with an edge at right angles to the cut, and the other two, or inside members, being sharpened at an angle of 45 deg. with the cut. When flint is encountered, the three-piece "Z"-shaped bit is employed.

The channelers carry their own boilers, and each one burns about 1¼ tons of Cherokee coal per day.

Tripod drills and air hammer drills are employed for splitting up the blocks into mill sizes. The equipment includes two Sullivan tripod machines. The blocks are handled by two 50-ton derricks, with masts of Oregon fir, 24 in. square and 65 ft. long, and having booms 20 in. in diameter by 55 ft. in length. They have handled blocks weighing 75 tons and have been used to turn blocks weighing 100 tons each.

Cost of Quarrying Dimension Sandstone. In *Engineering News*, Nov. 21, 1901, Mr. R. C. McCalla, Jr., gives the following: In October, 1891, 200 cu. yd. of backing and 600 cu. yd. of dimension stone were quarried for Lock 2, Black Warrior River, Tuscaloosa, Ala. The stone was a fine quality of blue sandstone quarried from the bed of the river at the falls, after diverting the water. The cost of quarrying these 800 cu. yd. was \$1,598, or about \$1 per cu. yd. for the backing and \$2.33 per cu. yd. for the dimension stone. In this month 434 cu. yd. of dimension stone were cut by stone cutters at a cost of \$6.83 per cu. yd. The masonry wall is 390 ft. long, 8 to 14 ft. wide, and 34 ft. high, built in courses of ashlar 18 to 24 in. thick, and about 50% cut stone. In October two gangs of masons, using two derricks, laid 1,563 cu. yd. of first-class masonry at a total cost of 92½ ct. per cu. yd., including the cost of screening sand, mixing mortar, operating steam hoists, unloading material at the wall and converting them into masonry. The itemized cost of the mason work was:

Foreman, 1 mo.	\$ 90.00
Masons, 202 days of 8 hr. at \$2.80	565.60
Laborers, 35½ days of 8 hr., at \$1.20	42.15
Laborers, 270½ days of 8 hr., at \$1.00	270.50
Laborers, 369½ days of 8 hr., at \$.80	295.70
Laborers, 146½ days of 8 hr., at \$.60	88.05
Boys, 83¼ days of 8 hr., at \$.40	33.30
Wages paid in board	42.00
Fuel for hoists	18.49

Total, at 92½ ct. per cu. yd. \$1,445.79

Quarrying by Water Cushion Blasts. The following method of quarrying is described in *Engineering Record*, April 7, 1900:

At Cobleskill, N. Y., limestone was quarried for the backing of the East River Bridge piers. Most of the backing is laid in 3-ft. courses; the stone is remarkable for its smoothness, many beds requiring no dressing. The quarry is a solid stratum 28 ft. thick, with vertical fissures at right angles to each other and up to 100 ft. apart. A row of vertical holes 3 or 4 ft. apart is drilled through the stratum from 3 to 10 ft. back of the face, depending on size of blocks required. The holes are filled three-quarters full with water, plugged, and a charge of black powder put in over the plugs and tamped. When fired, a block of solid rock 28 ft. high and perhaps 100 ft. long and 6 ft. thick, was separated and remained standing in its original position. Cross rows of vertical holes were drilled and fired similarly to the first holes, breaking the stone into blocks 10 ft. long and 28 ft. high. These blocks were thrown over and split with plug and feathers into blocks of thickness required for the courses.

Granite Quarrying. In most granite quarries steam drills, derricks and hoisting engines are the only machines used. In "sheet quarries" after a trench is blasted out to open up a face, if no natural face exists, then the two ends of the face are freed by making channels.

At the Crotch Island quarries, in Maine, two parallel rows of holes are drilled 3 ft. apart, the holes in each row being 8 in. apart and as deep as the sheet of granite, which varies from 2 to 16 ft. thick. These holes are charged with 60% dynamite, two sticks at the bottom of each hole, then a plug of wood 8 in. long on top, then a stick of dynamite 8 in. long on top of the wood, then another plug of wood, and so on until within 1 ft. of the mouth of the hole, which is tamped. A cap is placed in the last cartridge in each hole, and the holes are fired in pairs. It is not necessary to put a cap in any of the lower sticks as the shock sends them all off practically together. This heavy loading results in tearing the granite into chips which are often hurled a great distance, necessitating blasting at night; but the powdered granite left in the channel, is easily shoveled out, leaving a trench about $4\frac{1}{2}$ ft. wide. Having freed the two ends, a long block of granite, the thickness of the sheet, is loosened by blasting. The granite adjoining the channels when cut into blocks shows no sign of weakness in spite of the tremendous blow received in blasting.

I am indebted to the *Engineering Record* for the following description of the Crotch Island quarry:

A diagram of the method of working is shown in Fig. 133A,

not made to scale or true dimensions, but merely indicating the operations. 1-2-3-4 and 5 are successive strata of increasing height and from 5 to 12 ft. thick. Suppose that strata 4 is 9 ft. thick and it is desired to quarry from it stones 12 ft. long. On the required line B-H a pair of Lewis (any drill holes placed close together are called Lewis holes) holes about 12 in. apart and 9 ft. deep are made at D with a compressed air drill and black powder is fired in them; they are swabbed out, recharged and refired, and so on several times until a crack has been opened from J to L. Another similar pair of Lewis holes is made in the line of the crack about 40 ft. away at E and they are similarly fired. Holes are drilled at G-H and so on, and the crack is produced as far as desired, extending everywhere through to the stratum below. Holes 9 ft. deep are drilled 8

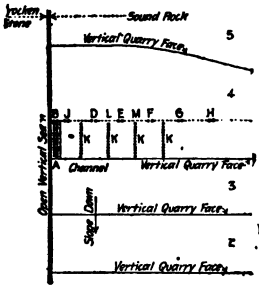

Fig. 133A. Granite Quarrying.

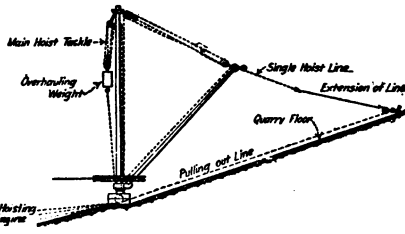

Fig. 133B. Removing Granite Blocks.

to 12 in. apart in two rows 3 ft. apart from A to B, adjacent to the open seam which bounds one side of the quarry to form the channel. The pair of holes nearest A are heavily loaded with dynamite and fired as above described, then the next pair are fired, and so on. Each blast pulverizes the granite between and close to the holes and throws the fragments so far that these blasts are fired at night when only the two men in charge remain on the island. When the whole set of holes has been fired a channel has been formed about 3½ ft. wide which extends through the stratum from A to B and gives a free face. The slab A-B-H-M, 12 ft. wide, 9 ft. thick, and perhaps 300 ft. long, is thus detached from the stratum, but is not moved more than the fraction of an inch from its original position. Blocks of any required width are laid off by lines (K-K-K, etc.) of small holes, which are drilled by hand, and the stone is split along them by the regular plug and feather method.

The method of removing these blocks is ingenious. Dog holes are made in each and the main line from a derrick, Fig. 133B, is attached and a strain is put on by the engine, but does not move it. The crack B-H is perhaps $\frac{1}{8}$ to $\frac{1}{16}$ in. wide, and in it, opposite the center of the blocks, are poured two cups of thick black oil at points about a foot apart. Between these points is poured a handful of black powder, which is covered with dirt, and has a fuse attached. The powder does not spread beyond the oil line, and so is confined in a thin sheet, filling the crack from top to bottom. When the fuse is lighted there is a light explosion which does not break the stone, but suffices to kick it out of its place. Thus started, it is easily pulled by the derrick line, over the smooth, steep slope of the underlying stratum to a point within reach of the derrick boom. There it is split into required sizes by plug and feathers, and the pieces are loaded by the derrick on cars, lowered down inclined track by cables to the two docks where other derricks load them on schooners for shipment.

Quarrying Granite at Barre, Vt. Mr. George H. Gilman (*Mine and Quarry*, Jan., 1916) gives a description of the granite industry at Barre, Vt. In 1910 there were about 55 separate workings scattered over an area of about two square miles. These quarries may be divided into two classes: (1) "sheet" quarries (Fig. 134), in which, as implied, the stone lies in sheets or layers, approximately horizontal and increasing in thickness as greater depths are reached; and (2) "boulder" quarries (Fig. 135), in which the joints are irregular and often crowded together.

Broach Channeling and Knox Blasting. Although the methods of working the sheet and boulder quarries differ in many respects, it is necessary in either case partially to free the stone from the bed or mass by broach channeling to avoid unnecessary fracturing of the rock upon blasting. In this system holes are drilled in a line usually about $3\frac{1}{2}$ in. apart from the center to center, having a thin wall or web between them. A flat bit or "broach" is then substituted for the regular drill steel and with the rotating mechanism of the drill released, the wall is crushed to the entire depth of the drilled holes or to the thickness of the sheet.

For broaching work of this nature, the Sullivan "UH" (3 $\frac{5}{8}$ -in.) drills are used extensively, and with them 15 sq. ft. of channeling per 8-hr. day is by no means an uncommon record. They are mounted upon heavy adjustable quarry bars and equipped with a special broaching head, which permits the rotating mechanism to be thrown out of gear by simply loosening a set screw.

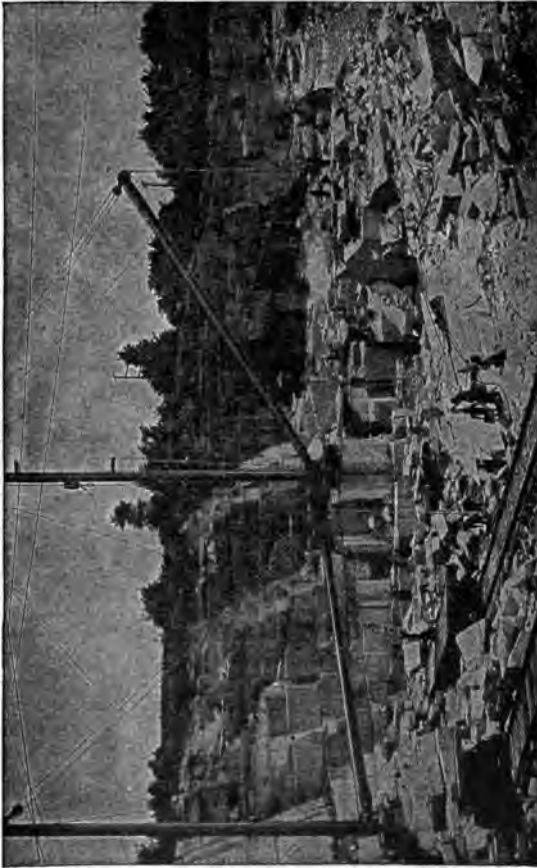

Fig. 134. Granite "Sheet" Quarry.

The amount of channeling necessary to remove a mass of stone is dependent upon its soundness and the number of free sides. As greater depths are reached more channeling is required, as it is often necessary to have the cut extend around four sides of the stone to be removed. On the fourth side it is freed by drilling three Lewis holes in alignment with the grain and in the direction at which the break is to be made. After this the holes are reamed, before loading and firing. By this method the break usually extends from one channel cut to the other, or to a seam or free end running parallel with it



Fig. 135. Granite "Boulder" Quarry.

as the case may be. Sullivan "UB" ($2\frac{1}{4}$ -in.) drills mounted upon a special Lewis hole tripod meet these conditions satisfactorily and are largely used. The holes are reamed by cutting two "V" shaped grooves on opposite sides of the hole (Fig. 127A) to start the break in the proper direction. This is accomplished by inserting in the chuck of the drill a diamond-shaped cutting tool, the edges of which correspond in shape to the grooves to be cut. The drill is then operated as in the case of broaching, with the rotating mechanism released. In this manner grooves may be cut in several holes in perfect alignment.

Plug Drilling. After the stone is loosened from the mass it is split to the proper dimensions by "plug" and "foot-holing." This consists of drilling a series of shallow "plug" holes about $\frac{5}{8}$ -in. in diameter and 3 to 4 in. deep, at intervals depending upon the character of the stone. When necessary larger and deeper "foot" holes are also drilled in alignment with the smaller ones but at greater intervals, to guide the break and to reduce the tendency of the break to run out of line, especially if there is frost in the stone. Steel "plugs" and "feathers" are then driven into the holes and the material split in a clear, smooth plane.

Air hammer drills are largely used for "plug" and "foot-hole" work, on account of their high drilling speed, efficiency and low cost of maintenance. One man with a hammer drill will do as much work in a given time as several men with hand hammers.

The Sullivan "plug" drill, on a test run, has drilled in these quarries 160 holes ($\frac{5}{8}$ -in. by 3-in. deep) in one hour, while the Sullivan "foot-hole" tool with hollow drill steel will drill $1\frac{1}{4}$ -in. holes 12 in. deep at the rate of 1.5 min. per hole.

Power. Compressed air is employed almost entirely for operating the percussive and hammer drills and practically all the quarries have independent air plants for this purpose. The air pressure in common use is 100 lb. per sq. in., although the tendency is to increase this, when conditions will permit, to as high as 120 lb.

Quarrying Massive Granite. When granite does not occur in beds or sheets of moderate thickness, the method practiced at Mt. Airy, in North Carolina, according to Merrill, is as follows: No quarry face is used, but a hole is drilled in the massive granite perpendicular to the surface, and to a depth of 6 to 12 ft., according to the thickness of the stone desired. This hole is loaded with a light charge of powder and fired, then it is loaded with another light charge and fired, and so on until cracks appear in the granite at the surface at a distance of 150 to 200 ft. from the hole, caused by the lifting bodily of a lens-shaped mass of the granite by the force of the powder. The blasting is repeated until the lens-shaped mass is almost free all around, when it is left for a day or two so that the stresses produced by the changes of temperature from day to night break the mass of granite entirely free. Then this lenticular mass is split with wedges into blocks that can be removed. (See Fig. 136.) This is a very ingenious method and one well worthy of introduction wherever granite occurs in massive form, but the most common method is as follows:

The granite is blasted out in large, irregular chunks, using

as small charges of powder as will affect the loosening of the rock, the method being in fact similar to ordinary open cut excavation. The largest and most regular blocks are selected for splitting up with plug and feathers, and the other stones are used as far as possible for rubble or concrete. In upper New York, on the Spier Falls Dam construction, and in Massachusetts, on the Wachusett Dam work, I have seen this method used on a large scale. On a smaller scale I have used it myself, but in all cases the cost of the dimension stone so secured has been excessive. The Adirondacks "granite" is an exceedingly tough stone, but in spite of the greatest care I have had cut stone break in two while handling them, because of the shattering effect of the dynamite; and black powder did not prove much more satisfactory. On both the large dams just mentioned it was found cheaper to import cut stone long distances than to use the local granite for certain parts of the cut stone work.

If granite boulders occur, they can be split up with plug and feathers yielding splendid blocks. In fact the early quarrying in a granite region is apt to be boulder quarrying; and, in consequence, quarries of massive granite that is blasted out in rough chunks and split with plugs and feathers, are often called boulder quarries.

An effective way of making "boulders" is by large chamber blasting, where the amount of stone required warrants quarrying on such a large scale.

Splitting Granite by Compressed Air. (*Engineering and Mining Journal*, May 19, 1906, and July 31, 1909.) In the Mt.



Fig. 136. Splitting Granite by Compressed Air, at Mt. Airy.

Airy Quarries (see Fig. 136), described in the last paragraph where the granite is comparatively free of ledges or joint planes and splits readily in almost any direction, compressed air was applied, to form artificial ledges or working faces. A drill hole 2 or 3 in. in diameter was sunk 6 or 8 ft., and the bottom of the hole was sprung with dynamite. Following this a handful of black powder was exploded in the pocket, starting a horizontal cleavage crack. Charges of increasing size were then exploded in the cavity, the drill hole being plugged at each blast in order to confine the powder gases and thus exert a nearly constant force upon the rock. After the cleavage had extended 75 or 100 ft. in all directions, a pipe was cemented into the hole, and air at 70 lb. pressure was carefully admitted, being regulated by a globe valve. The stone could be heard cracking in every direction, and in about half an hour, as the pressure was increased to 100 lb. the cleavage came to the surface, usually within a radius of 250 ft. of the drill hole.

This method effects a material saving in the time occupied as compared with the method described on page 577 by powder alone, which usually occupies from two to three weeks.

Cost of Quarrying Granite. Cost data relating to the quarrying of granite dimension stone are extremely hard to secure. I have been able to find only one writer, Mr. J. J. R. Croes, who has published anything on the subject. Mr. Croes' records, together with mine, will at least form a basis for approximate estimates of cost of granite quarrying. My data apply to quarrying three-dimension stone in a sheet quarry on the coast of Maine. The total number of men engaged was, on the average: 6 enginemen, 6 steam drillers, 6 drill helpers, 3 blacksmiths, 3 helpers, 5 tool and water boys, 38 quarrymen, 47 laborers, 2 foremen and 1 superintendent. This force quarried and loaded on boats about 1,400 cu. yd. of rough granite blocks. The stone was loaded by derricks onto cars, from which it was unloaded into boats ready for shipment. The following cost includes everything except interest and depreciation of plant, and development expenses:

	Per cu. yd.
Enginemen, at \$2 a day (of 9 hr.)	\$.20
Steam drillers, at \$2.0020
Drill helpers, at \$1.5015
Blacksmiths, at \$2.7514
Blacksmiths' helpers, at \$1.7509
Tool and water boys, at \$116
Quarrymen, at \$1.75	1.09
Laborers, at \$1.50	1.15
Foremen, at \$3.0015
Superintendent, at \$820
Coal, at \$5 ton45
Explosives25
Other supplies30
Total	\$4.53

On the best month's work, when a larger force was being operated, the cost of all labor, superintendence and supplies, was reduced to a little below \$4 per cu. yd.; but the above, \$4.50 per cu. yd. may be taken as a fair average of several months' work. To this should be added the charges for plant rental, quarry rental (if any), stripping (if any), and freight charges to destination. The freight rate by boat from Maine to New York is about \$1 a ton, but as rough granite blocks are always measured on their least dimensions, the freight charges when \$1 per ton amount to about \$2.70 per cu. yd., of three-dimension stone in the rough. The explosives used were black powder, costing \$2.25 a keg (25 lb.), and dynamite for channeling, costing 15 ct. a lb. The sheet from which this granite was quarried averaged about 6½ ft. thick, and was nearly flat. The stone was loosened in long blocks by Knox blasting with black powder, and was split up into sizes by plug and feathering; both hand drills and pneumatic plug drills being used for this purpose. The stone, as before stated, was three-dimension stone. To quarry random stone (not rubble) in this quarry cost about \$3.50 per cu. yd.

Cost of Quarrying Gneiss. Brief, but reliable data on the quarrying of stone for the Boyd's Corner Dam, near New York City, are given by Mr. J. J. R. Croes, in *Trans. Am. Soc., C. E., 1875*. The stone is a gneiss that is found in and about New York City, and containing so much mica that it is more properly called mica-schist. The face stone for the dam average 1.8 ft. rise, 3.6 ft. long and 2.7 ft. deep, and were cut to lay ¾-in. joints. In quarrying the dimension stone, plug and feathers were used to split the stone to size ready for cutting. The cost of quarrying and plug and feathering 4,000 cu. yd. of dimension stone ready for cutting was as follows:

	Days (10-hr.) per cu. yd.	Cost, \$ Per cu. yd.
Foreman, at \$3114	\$.34
Drillers, at \$2917	1.84
Laborers, at \$1.50429	.65
Blacksmiths, at \$2.50102	.25
Tool boys, at \$.50108	.05
Labor loading teams, at \$1.50284	.42
Total (not including explosives and teaming)		\$3.55

The work was done by contract in 1867-8. The rates of wages were not given by Mr. Croes, but Mr. John B. McDonald has been kind enough to give me most of the rates of wages as nearly as he can remember. The length of haul from quarry to stone yard was about a mile, and Mr. McDonald states that oxen were used. The cost of "teams" is given by Mr. Croes as 0.62 team days per cu. yd., which indicates that a good deal of stone boat work was done, or else that there is an error in this item.

The cost of quarrying 3,400 cu. yd. of rubble stone for this same dam was as follows:

	Days per cu. yd.	Per cu. yd.
Foremen, at \$3041	\$.12
Drillers, at \$2339	.68
Laborers, at \$1.50140	.21
Blacksmiths, at \$2.50036	.09
Tool boy, at \$.50035	.02
Labor, loading teams, at \$1.50077	.12
Teams, at \$4141	.56
Total labor		\$.80

It is presumable that both the dimension stone and the rubble stone were measured in the dam.

Cost of Quarrying Sandstone. In quarrying thin bedded sandstone for dry slope walls and rubble, I have found that one quarryman will average about 2 cu. yd., per 10-hr. day. In doing this work no powder is used where the beds lie free, but if they are cemented together it is necessary to shake up the ledge with light charges of black powder. Wedges, crow-bars and hammers are the only tools needed for quarrying thin bedded stone where the beds can be separated by driving wedges in between them. The stone quarried thus is not very regular, except on the bed joints; and, when it is dressed up by the mason, there is a considerable shrinkage in volume between the measurement of the stone corded on a stone rack and the stone measured in the wall. The mason uses the spalls to fill in the vertical joints, so that there is little or no real loss of stone. In quarrying several thousand cu. yd. of stone for dry slope wall masonry, I found that 2 cu. yd. of stone, measured corded on the wagon, made 1.55 cu. yd. of slope wall. Each quarryman averaged 2 cu. yd. per day of stone as measured in the wall, or 2.6 cu. yd., measured corded in wagons. These quarrymen received \$1.75 a day, and as practically no powder was used, the cost was 88 ct. per cu. yd. for quarrying stone measured in the wall, and this included loading onto wagons, but not hauling.

Cost of Quarrying Limestone. Mr. James W. Beardsley is authority for the following data on the cost of quarrying limestone for retaining walls on the Chicago Main Drainage Canal. The contractors selected parts of the canal where the limestone occurred in strata that were uniform, so that the beds of the stone quarried required no dressing. The stone was laid in courses averaging about 15 in. thick, the better stone being selected for the face of the wall. Guy derricks having a capacity of 6 to 10 tons, boom 40 to 60 ft. long, operated by a hoisting engine, were used for loading the stone. Black powder was used to shake up the ledges, and the stone was then barred and wedged out. The cost per cubic yard is the average of 93,500 cu. yd., measured in

retaining walls. The mortar was only 13¼% of the wall, indicating an unusually even bedded stone that squared up well. The cost does not include general superintendence, installation of plant, plant rental, powder, material for repairs, and cost arising from delays.

	Typical force.	Wages per 10 hr.	Per cent. of cost.	Cost per cu. yd., ct.
General foreman01	\$4.75	.9	.9
Foreman	1.00	3.50	10.6	7.8
Derrickmen	2.11	1.50	10.2	7.5
Quarrymen	8.42	1.05	42.3	81.2
Enginemen	1.10	2.25	7.0	5.2
Firemen04	1.75	.2	.3
Laborers	2.28	1.50	10.9	8.0
Water boys33	.75	.9	.7
Blacksmiths27	2 to 3	1.8	1.3
Blacksmiths' helpers18	1.75	.9	.7
Carpenters02	2.25	.1	.0
Drill runners36	2.00	3.1	2.3
Drill helpers07	1.50	.4	.2
Watchmen04	1.50	.1	.1
Teams and carts29	3.50 and 2.50	3.8	2.8
Derricks	1.12	1.35	5.4	4.0
Drills36	1.15	2.1	1.5
Total	16.52 (men)		100.0	73.7

This cost of 73.7 ct. per cu. yd., it should be borne in mind, is the cost of quarrying rubble stone occurring in regular beds. The cost of quarrying Manhattan gneiss and sledging into sizes fit for rubble is given on page 580.

CHAPTER XIV

OPEN CUT EXCAVATION IN RUBBLE QUARRIES, PITS AND MINES

General Considerations. In this chapter will be discussed quarrying "rubble" (for "dimension stone" quarrying see Chapter XIII) and open cut excavation in pits and mines. Subsequent chapters discuss open cut excavation for canals, railroads, etc.

The removal of the earth "over burden," as the English call it, or the "stripping" as it is termed in America, is discussed in my book on "Earth Excavation," so that no space will be given here to that factor of cost. In selecting a quarry site, of course the character and depth of stripping should always receive careful consideration, bore holes and test pits being sunk to ledge rock. Another feature that should never be overlooked is the drainage. A pit dug below the level of the lowest natural drainage channel will often make excavation exceedingly expensive where much water flows or seeps into it, and in winter it may drift full of snow, making work impracticable. I have opened several small quarries in the bed of streams that run nearly dry in summer, for in such places the stripping is likely to be slight. Quarries are preferably located in the side of a hill where gravity drainage will be secured. Moreover, in such a location there is generally no need of snatch teams or hoisting engines to haul the wagons or cars out of the pit; whereas, in a pit below the level of the surrounding country there is a constant outlay of money for raising the excavated rock.

Excavation in Benches. In deep, open cuts or pits, the rock is usually excavated in two or more benches or lifts. On the Chicago Canal, for example, the rock cut was about 36 ft. deep, and it was taken out in three 12-ft. lifts. There are two factors that determine the economic height of a lift: (1) the depth to which the drill will bore economically, and (2) the size into which the rock breaks upon blasting. With the ordinary 3½-in. percussive drill, about 16 to 20 ft. is the limiting depth of economic drilling, but with a 3½-in. drill it is often economic to drill 24 ft. If a cable drill is used, it is possible to go down 100 ft. or more. The height of the bench, however, is not dependent solely upon the economic depth of drilling. The higher the bench the farther back from the face may the row of drill holes be located, but the

farther back that the drill holes are placed, the larger will be the chunks of rock thrown down upon blasting, unless the rock is exceedingly friable. If, in a hard limestone, for example, the bench is 25 ft. high, and the drill holes are placed in a row only 9 ft. back of the face, the blast may blow out the bottom of the bench, and leave the top overhanging; and even if the top were to fall it would come down in very large chunks, although the bottom might be broken up to the desired size. This objection to a high bench with drill holes close to the face may be overcome by separating the charge in each hole into two or more parts, with tamping between; and, as a matter of fact, I am surprised that this is not done oftener.

We have seen in Chapter V that it pays to drill as deep a hole as the capacity of the drill will permit in order to reduce the time lost in moving from hole to hole. It should be added that the depth of the hole should ordinarily be some multiple of 2 ft. (if the feed screw is 2 ft. long) for once a new bit is in place it should be made to drill as far as the feed will permit. This rule should be ignored where other reasons prevail; thus, in stratified rock it is often well to stop the drill hole just short of a seam of stratification.

In order to increase the height of the benches, a common expedient is to drill one or two rows of nearly horizontal holes in the face of the bench, as well as the row of vertical holes, as shown in Fig. 139. This can ordinarily be done only where the bench is long enough to permit drillers to work on the floor at one place while the loaders are working at another place. This is a good expedient to employ where one portable drilling plant is used to work two or more quarries, for in this way a high bench can be blown down at one blast, instead of taking it down in two shallow benches, and thus time is saved in moving the drilling plant. It is also an expedient often used in side hill cutting where a steam shovel is used for loading.

Spacing Holes. A common rule is to place the row of vertical drill holes a distance back from the face equal to the depth of the drill hole, and to place the drill holes a distance apart in the row equal to their depth. Another rule is to place the row of holes back from the face a distance equal to three-fourths their depth, and the same distance apart in the row. In stratified rock of medium hardness these rules may be followed in making the first experiments, but they will lead to serious error if applied to dense granitic rocks.

In pit mining at the Treadwell Mine, Alaska, the holes are drilled 12 ft. deep, in rows $2\frac{1}{2}$ ft. apart, the holes being 6 ft. apart in each row and staggered, as shown in Fig. 137. This requires drilling 1.7 ft. of hole per cu. yd. I am indebted to

Mr. Robt. A. Kinzie for this information. The ore is a tough syenite, and the holes are spaced closer together than would be necessary if the crushers were large enough to receive bigger chunks.

In crushing ore or rock on a large scale the mining man and the contractor should bear in mind that it is poor economy to install small crushers, especially where the rock is so tough that it breaks out in large chunks; for a small crusher means not only money lost due to drilling holes close together, but it usually means labor and powder expended in sledging and blockholing the rock before it will enter the crusher.

It is obviously impossible to lay down any hard and fast rule for the spacing of drill holes. In stratified rock that is friable, and in traps that are full of natural joints and seams, it is often

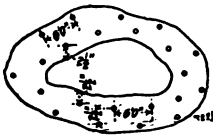

Fig. 137.
Drill Holes.



Fig. 138
Plan of Bench.



Fig. 139.
Profile of Bench.

possible to space the holes a distance apart somewhat greater than their depth, and still break the rock to comparatively small sizes upon blasting. In tough granite, gneiss, syenite and in trap where joints are few and far between the holes may have to be spaced 3 to 8 ft. apart, regardless of their depth, for with wider spacing the blocks of stone thrown down by blasting will be too large to handle with ordinary appliances. The mica-schist, or gneiss, of Manhattan Island is a good example of rock that requires close spacing of holes regardless of depth. I have seen holes in it 20 ft. deep and only 4 ft. apart.

The effect of spacing of holes upon the cost of excavation is best shown by tabulation of the feet of hole drilled per cubic yard excavated, as shown in Table LXVII.

TABLE LXVII

Spacing of holes, ft. 1 x 1	1.5 x 1.5	2 x 2	2.5 x 2.5	3 x 3	3.5 x 3.5	4 x 4
Cu. yd. per ft. of hole 0.04	0.08	0.15	0.23	0.33	0.45	0.59
Ft. of hole per cu. yd. 27.0	12.0	6.8	4.3	3.0	2.2	1.7
Spacing of holes. 4 x 5	4.5 x 4.5	5 x 5	5 x 6	6 x 6	6 x 7	7 x 7
Cu. yd. per ft. of hole 0.74	0.75	0.93	1.11	1.33	1.55	1.80
Ft. of hole per cu. yd. 1.35	1.33	1.08	0.90	0.75	0.64	0.56
Spacing of holes. 7 x 8	8 x 8	8 x 9	9 x 9	10 x 10	10 x 12	12 x 12
Cu. yd. per ft. of hole 2.07	2.37	2.67	3.00	3.70	4.44	5.33
Ft. of hole per cu. yd. 0.48	0.42	0.37	0.33	0.27	0.23	0.19

Spacing of holes.....	12 x 14	14 x 14	14 x 16	16 x 16	16 x 18	18 x 18	19 x 19
Cu. yd. per ft. of hole	6.23	7.22	8.30	9.48	10.67	12.00	13.37
Ft. of hole per cu. yd.	0.16	0.14	0.12	0.11	0.09	0.08	0.07
Spacing of holes.....	19 x 20	20 x 20	20 x 25	20 x 30
Cu. yd. per ft. of hole.	14.07	14.81	18.51	22.22
Ft. of hole per cu. yd.	0.07	0.07	0.05	0.04

Since in shallow excavations the holes can seldom be much farther apart than 1 to 1½ times their depth, we see that the cost of drilling per cubic yard increases very rapidly the shallower the excavation. Thus an excavation 2 ft. deep, with holes 2 ft. apart, requires 4.3 ft. of drill hole per cubic yard, as against 0.42 ft. of hole per cu. yd. in a deeper excavation where drill holes are 8 ft. apart. Failure to consider this fact ruined one contractor on the Erie Canal deepening, where rock excavation was only 2 ft. deep. Furthermore, as we have seen in Chapter V, the cost of drilling a foot of hole is much increased where frequent shifting of the drill tripod is necessary.

Sometimes granites and traps, even though tough, will break up under the blast for several feet back of the last row of drill holes. Fig. 138, for example, shows a trap rock quarry in which the holes averaged 10 ft. apart and 14 ft. deep, but the rock was full of joints and broke readily, as is indicated in Fig. 139, which shows that the rock broke 3 to 4 ft. beyond the drill holes when the dynamite exploded. Sedimentary rocks often break for much greater distances back of the last row of holes; and this is especially so when the holes have been sprung and charged heavily with black powder. The higher grades of dynamite are more shattering in the immediate vicinity of the drill holes, but are not so apt to break the rock up a short distance away.

By observing carefully the appearance of rocks in different localities it is possible in a short time to become tolerably proficient in the art of estimating the probable distance apart that holes must be drilled for the best effect with given charges of given kind of explosive; and with this end in view a young man should avail himself of every opportunity of studying prevailing practice in spacing drill holes in different localities.

Cable Drill Holes in Quarry Work. The use of cable well drilling machines for drilling deep blast holes in quarries and mines having high breasts, and the stone from which is intended for crushing, milling or cement manufacture, is rapidly gaining favor. Chapter VII contains the cost of operating cable drills and further examples will be found in subsequent chapters.

In *Engineering and Contracting*, Dec. 15, 1909, data concerning an experimental blast at the quarries at Warwick, Ohio, are given. The ledge, 40 ft. high, is worked for crushing silica sand. *An experiment was made to determine the comparative advantages*

of working a ledge by means of shallow holes and light charges and by means of deep holes and heavy charges. The deep holes proved a success, as a large amount of material was thrown down at one time, thus lessening the interference of the blasting with the workmen. The material was in better condition for handling and the cost was greatly decreased.

A Cyclone cable drill drove 4 holes 13 ft. from the face and 13 ft. apart. These holes were 4 in. in diameter and 40 ft. deep. They were sprung with dualite and then charged with 275 lb. of dynamite. The volume loosened was 1,387 cu. yd., the pieces averaging 50 lb. exclusive of fine material. The cost of the blast was as follows:

	Per Cu. Yd.
Drilling and charging	\$0.048
Explosive	0.120
Total	<u>\$0.168</u>

The drilling was done by contract for 30 ct. per ft. of hole.

The above cost was much higher than subsequent blasting of similar nature would be, due to the experimental nature of the work.

According to *Engineering Record*, Aug. 2, 1913, in a cement quarry opened several years ago on the Hudson River near Glens Falls, N. Y., and worked for about three years before there was sufficient space between the quarry face and the river to throw a big tonnage of stone, a cable drill, electrically operated, has been substituted for tripod percussive machine drilling. During the time when space was insufficient for large blasts, small blasts were necessary and two tripod drills, each operated by two men, were used steadily to drill 1.5-in. holes from 12 to 14 ft. deep, furnishing the mill with approximately 650 tons of stone per day. As the work progressed away from the river the height of the ledge increased to 65 ft. and it required five benches and five series of blasts to face the rock from top to bottom. The extra work required to clear away the broken stone caused the quarry cost to run rather high, and it was decided to drill blast holes of greater diameter and depth.

A Keystone cable drill, equipped for 6-in. holes, driven by an electric variable-speed induction motor, was installed. Connections to the motor were made with the power line passing near the quarry at three different poles on which the line was strung, the slack of the wire being rolled over a drum. As the electric current was already available in the quarry, it was estimated that a considerable saving over the cost of operating a steam-driven machine could be affected. In addition, the services of two men that would have been required to run a steam-driven

machine and the extra expense of hauling coal and water were eliminated.

A laborer, who was totally unacquainted with cable drills, and whose maximum wage had been \$2 per day, was selected to operate the drill, and was trained by an experienced drill man. During the training period it was shown that a footage of 30 to 35 ft. per day, including moving machine from hole to hole, might be expected under ordinary conditions. With this as a basis, the new drill runner was placed under contract at 9 ct. per ft. of hole drilled, all equipment to be furnished to him.

The overburden was first stripped from the rock, leaving the remaining material about 75% hard limestone and 25% fairly soft slate. The total cost for drilling, as reported by Mr. F. L. Jorgensen, superintendent of the Glens Falls Portland Cement Co., averaged less than 15 ct. per ft., which includes repairs, oil, power, driller, etc. The actual reduction of the quarry pay-roll due to the adoption of this method, is reported between \$12,000 and \$15,000 per year, of which sum approximately \$2,000 a year is saved on the cost of drilling, and \$10,000 to \$13,000 is saved in bench-cleaning, track-moving, etc. To supply 650 tons of stone per day, the drill has to work only 60% of the time.

With the tripod percussive drills, the 1.5-in. holes were drilled 6 ft. back from the face of the quarry, 6 ft. apart and 12 ft. deep. With the new cable drill the 6-in. holes were drilled 20 ft. back of the face, 20 ft. apart, and a total depth of 65 ft. to the bottom of the quarry. About 500 lb. of 40% Red Cross dynamite were used in each hole, and from 4 to 12 holes were shot at a time. No increase in the consumption of explosives occurred either in the initial blasting or in the breaking up of the big boulders. Loading of stone was done by hand as "piece work." Large boulders were broken up for the loaders, who then broke up and loaded the smaller pieces on the cars, for which work they received about \$2.50 per day, at a rate of 10 ct. per ton, assuming that the stone weighed 2 tons per cu. yd. This would be at the rate per man day of 12.5 cu. yd. (solid) sledged and loaded. While this was not a high record, it is better than the average day's work, as may be seen by reference to Chapter XVI, where we note that on the Chicago Canal, the average per man loading into low skips, involving very little sledging, was about 10 cu. yd. of solid rock per 10 hr. shift.

Drill Wagons in Quarry Work. (*Engineering and Contracting*, Jan. 6, 1915.)

At the quarry of the Dewey Portland Cement Co., Dewey, Okla., the one thing to be accomplished was the getting out of the material in condition suitable for the crushers and at as low a cost as possible for the operation. The surface of the rock was

practically level and the general scheme was to drill holes to a uniform depth and about 10 ft. apart, loading them with 3-in. 40% gelatin and firing a large area at once, the object being to raise the rock and break it up, and not to throw it out into the quarry, the subsequent handling of the rock being done by a steam shovel.

The drilling was all done by one drill wagon equipment. This comprised a standard Ingersoll-Rand H-64, 20-ft. feed, turntable drill equipped with a 35 hp. boiler. Ordinarily the machine was operated by one drill runner and one helper, and when necessary to move the track additional help was called up from the steam shovel and switching gang in the quarry. It was considered, however, that there should be three men constantly attached to the drill to run it most efficiently, as even though the boiler was gas fired, it required considerable attention to keep the steam right, and the one helper could hardly find time to keep things going all right at each end of the wagon.

When demonstrated for acceptance this drill did from 140 ft. to 200 ft. of 3¼-in. hole per 10 hr. day, the holes being from 18 to 20 ft. deep. The drill was sold under a 150-ft. guarantee, which was easily made to the satisfaction of the quarry owners, and no attempt was made by the demonstrator to make or break any records, most of his time being spent in teaching the new operator how to get the best results. Another reason for not attempting any records in this case was in the fact that there was great objection to the water used in washing the cuttings out of the hole, as the rock mixed with this water becomes more or less muddy and does not go through the crusher as well, so that it was necessary to reduce the supply of water to a minimum and then the drill throttle could not be opened to take full advantage of the power available. Under other conditions the drill would not be under this handicap, and could make a still better showing.

At each setting of the wagon on the track one hole would be drilled on one side, with the drill pointed in that direction, and then the turntable would be given half a turn for drilling a corresponding hole on the other side of the track; after moving the machine along 10 ft. on the track two more holes would be drilled in the same way, and so on.

Spacing and Charging Cable Drill Blast Holes. The amount and arrangement of the charge for deep holes depends upon the nature of the rock, the purpose for which it is to be used and the size, depth and spacing of the holes. It is essential to have the charge properly distributed, which is usually done by "double" or triple loading, that is by "breaking the load" or dividing the charge into two or three parts. For holes of 100 ft. depth in limestone quarries a charge of about 500 lb. of 60%

dynamite at the bottom, with charges of 40% dynamite above it, with good, firm tamping between. The 60% dynamite "kicks out the bottom" and the 40% dynamite, aided by gravity, breaks off and permits the upper part of the breast to fall. In general a hole should be filled at least half its length with explosives, and the upper charge should come within 20 or 30 ft. of the surface.

Loading and Tamping Cable Drill Holes. Slit the cartridges of dynamite, if that is the explosive used, in two or three places longitudinally without removing the wrapper. Drop from 10 to 15 lb. in the holes at one time until near the top of the charge, when it may be dropped 25 lb. at a time. It is safer to lower the explosive by means of one of the loading devices described in Chapter X. The charge should have two primers in the bottom loading, one about one-fourth way up the charge and the other near the top. This is particularly important on deep hole work because of the value of a hole and the danger of losing it through a defective circuit. For the same reason all fuses and circuits should be tested with a galvanometer before and after loading.

A tamping block is usually of wood about 4 ft. long and small enough to work easily in the hole. Its weight may be increased by boring a hole through it lengthways and filling with babbitt or lead. To this a rope is fastened and the block is worked up and down by hand. For very deep holes it is best to have a light tripod with a pulley at the top. Two men can easily and effectively operate the tamping block with a rope over the pulley. This is less expensive than operating it with the pump reel line of the drill, as it not only works more quickly but permits the use of the drill at its proper work of drilling.

The tamping should be thoroughly performed in the usual manner and it is best carried clear to the mouth of the hole. If it takes more than one day to load the holes, do not connect the fuse wires of the loaded holes. Bury the ends of the wires in the earth. An electric storm may set off the blast.

The Shore Line Stone Co. at Monroe, Mich., operates a limestone quarry which has a face averaging 50 ft. in height. The rock consists of a heavy limestone stratum 8 to 10 ft. thick near the bottom of the face and another of the same thickness about 15 ft. above the bottom, with thinner strata between and above. Holes 5 in. in diameter are spaced 12 ft. from the face and 12 ft. apart. Each hole is loaded with about 75 lb. of 40% dynamite in the bottom, then filled with tamping to the upper heavy stratum, where 75 lb. more are charged. The hole is tamped well to the top with clay and sand. One exploder is used in the lower charge and one in the upper. Six to ten holes are shot

at one time. The stone is loaded on cars by hand and must therefore be well blasted.

In the Woodville Lime and Cement Co. quarry at Toledo, Ohio, holes 5 in. in diameter are spaced 10 ft. from the face and 14 ft. apart, and are drilled to a depth 2 ft. below the floor. The height of the face is 32 to 36 ft., with the strata averaging 6 ft. in thickness. The holes are loaded to a height of 6 ft. with 60 lb. of 40% dynamite and tamped to the mouth.

In a quarry operated by the Glens Falls Portland Cement Co. of Glens Falls, N. Y., on the bank of the Hudson River, the holes are 6 in. in diameter, 65 ft. deep, and 20 ft. from the face and from each other. About 500 lb. of 40% Red Cross dynamite is used per hole, and from 4 to 12 holes are shot at one time.

Table LVIII in Chapter XI gives the statistics of a number of cable drill hole blasts.

Cost of Drilling Limestone with a Cable Drill. (*Engineering and Contracting*, July 21, 1909.) To obviate the disadvantages connected with the steam machine as used in certain classes of work, the Keystone Quarry Drill Co. has designed an electric driven cable drill, and one of these has now been at work for some time in the Belleville, Ill., quarries of James & A. C. O'Laughlin, of Chicago, Ill. The following data relate to this machine and its work:

The machine is equipped with a 10-hp. specially geared motor placed over the rear truck and belted to the drilling mechanism, which is back geared and balanced so as to run lightly and smoothly. The controller box is located at the front of the machine close to the driller's hand. The drilling tools comprise a stem weighing about 1,000 lb., a drill bit weighing 150 lb., and a rope socket weighing about 50 lb., or about 1,200 lb. together. The bit cuts a 5 $\frac{1}{8}$ -in. hole and the stem is 3 $\frac{1}{4}$ in. in diameter and 22 ft. long. The stroke is from 30 to 36 in. The machine is built with gear hoist, capacity 500 ft., or with friction hoist, capacity 350 ft. The makers consider the latter style of machine probably the best for quarry and rock cut work where the tools are being constantly raised and lowered as in tamping a charge, and where the holes will rarely exceed 150 ft. in depth. This machine is made with a traction attachment for self propulsion if desired; while it is impracticable to move the machine over great distances by this means, on account of carrying along the electric feed wires, for short moves from hole to hole or from one side of the quarry to the other it has been found to be of great advantage.

In operating at the full speed of the motor the tools make about 60 strokes per min. As the hole becomes deeper or clogged with

cuttings, before sand pumping, the rapidity of the stroke is gradually reduced to say 50 strokes per min., so that the cutting bit may deliver its blow with best effect.

Besides doing the drilling this machine is used for loading the holes. For this service the regular drilling bit is removed and in its place a wooden rammer is placed on the drill stem. From 5 to 8 sticks of dynamite having been dropped into the hole the drilling tool is lowered after them, forcing them to the bottom. The tools are then withdrawn and the operation repeated until all the charge is placed. The placing of the firing cap and wires and the tamping are done by hand.

At the O'Laughlin quarry, limestone is drilled and blasted for crushed stone. The machine was furnished by the makers on the guarantee to drill to a depth of 60 ft., at the rate of 40 ft. per 10-hr. day, or 4 ft. per hr. In the tests made on delivery of the machine the following records were obtained: The machine was set up on June 5 at 5 o'clock and ran for 1 hour, drilling 9 ft. of hole. From the following Monday morning until Friday forenoon, something over 4 days, working 10 hr. a day, four 66-ft. holes, or 264 ft. of hole were drilled. In the following week four holes 105 ft. deep, or 420 ft. of hole were drilled. These figures are furnished by the Keystone Quarry Drill Co. In a letter to us the James & A. C. O'Laughlin Co. state that in actual work the machine is averaging 40 ft. of 5 $\frac{7}{8}$ -in. hole per 10-hr. day, and is giving satisfaction. The daily operating expenses are as follows:

One drill runner	\$2.50
One helper	2.00
Cost of electric current	2.00
Oil, drill sharpening, etc.	1.50
Total per day	\$8.00

This gives a cost per foot of hole drilled of 20 ct., exclusive of repairs, interest depreciation, and general supervision.

In a blast of four 5 $\frac{7}{8}$ -in. holes 66 ft. deep, the charge consisted of 5,500 lb. of dynamite packed solidly in the holes to within 25 ft. of the top and then tamped with screenings. The quarry manager estimated that 20,000 cu. yd. of stone were thrown down by this blast. The breast was 105 ft. high, and, as will be seen, the holes were put down only about half way. In recent work the holes have been drilled the full depth of the breast.

Cost of Quarrying Trap for Macadam. The following is an average of the cost of quarrying in several different trap quarries, taken from my own records. The tap was hard to drill, being *seamy*, but in consequence of its seaminess it broke up well when 75% dynamite was used. Holes averaged 14 ft. in depth, and three of these holes per day of 10 hr. were drilled with a 3 $\frac{1}{4}$ -in.

percussive drill using steam from a portable boiler. The cost of operating the drill was:

1 driller	\$ 3.00
1 helper	2.00
1 fireman	2.00
* 20 bits sharpened at 5 ct.	1.00
1/2 ton soft coal at \$3.75	1.25
Hauling water for boiler	0.75
Oil and waste	0.25
Drill interest and maintenance	0.75
Boiler do	1.00

Total\$12.00

* At a custom blacksmith shop near the work.

The number of feet drilled was low, so that the cost of drilling was nearly 30 ct. per ft. of hole. It required about 0.35 ft. of hole per cu. yd. of rock (solid measure), so that the cost was 10 ct. per cu. yd. for drilling. Common laborers, at \$1.50 a day, sledged the rock to sizes that would enter a 9 x 16-in. crusher, and threw the stone back away from the quarry face ready to be loaded and hauled to the crusher. Much of the rock was already broken small enough by the blast, so that a man averaged 7½ cu. yd. (solid) a day sledged and thrown back. The items of cost per cu. yd. (solid) were as follows:

	Cts. per cu. yd. (solid).
Stripping	5
Drilling	10
Sledging	20
Dynamite (75 p. c.), 0.2 lb. at 25 ct. in the hole.....	5
Total	40

This is the cost per cu. yd. solid (not including loading and hauling away), but 1 cu. yd. solid makes about 1.7 cu. yd. when broken; hence the cost of quarrying was about 24 ct. per cu. yd. measured after breaking.

In loading this broken stone into carts one man would load about 15 cu. yd. (measured loose) per day. A man will load into wheelbarrows and wheel a distance of 100 ft., dump and return, at the rate of 10 cu. yd. (measured loose) per day. Further data on the cost of transportation will be found in Chapter XII. It will be noted that these data apply to quarrying on a small scale, with a portable plant, in tough rock, but that the rock was seamy and the face fairly high (20 ft.), as shown in Fig. 139. Two men pumping out drill holes and carrying dynamite to two men charging consumed an hour in charging six holes with 50 lb. of dynamite, or at the rate of 12½ lb. per man per hour, or about 1½ ct. per lb. of dynamite for charging, tamping and firing.

Cost of Quarrying and Crushing Limestone. I have had occasion to open limestone quarries where a face only 5 or 6 ft. high could be worked without doing a great deal of stripping.

The following was the average labor cost of quarrying and crushing 60 cu. yd. loose measure, or 35 cu. yd. of solid rock, per 10-hr. day, the average being that of 4,000 cu. yd.:

Quarry	Crusher (9 x 16 in.)
1 driller	1 engineman
1 helper	2 men feeding
1 man stripping	6 men wheeling
4 men quarrying	1 bin man
1 blacksmith	1 general foreman
Total	Total
\$14.00	\$19.50

The "four men quarrying" barred out and sledged the blasted stone to sizes that would enter the crusher; the "six men wheeling" wheeled it in barrows about 150 ft. to the crusher, and delivered it on a platform. The dynamite used was 40%, at 12 ct. per lb., and 0.4 lb. was used per cu. yd. of crushed rock, or 0.7 lb. per cu. yd. of solid rock. One electric exploder, costing 3 ct., was used per pound of dynamite. A long ton of coal, at \$2.50, and a gallon of oil, at 25 ct., were used per shift for both crusher and drill. Holes were drilled about 5 to 6 ft. apart, the face being 5 to 6 ft. high, and the drill averaged 60 ft. per shift. Summarizing we have:

Wages of quarry crew	\$14.00
Wages of crusher crew	19.50
24 lb. of dynamite with exploders, at 15 ct.	3.60
1 ton of coal	2.50
1 gallon of oil25
Total	\$39.85

This is equivalent to 66 ct. per cu. yd. of crushed stone measured in the bins, which is a high cost, due to the low quarry face, and the small plant operated. Current repairs to the drill cost 1 ct. per cu. yd. and the crusher another 1 ct.; steam hose, drill steel and sundry supplies cost another 1½ ct. per cu. yd. of loose rock. Quarry rent was 5 ct. per cu. yd.

Cost of Pit Mining, Brewster, N. Y. In the magazine, *Stone* (New York), 1892, page 414, Saunders gives the following data of cost of ore bank blasting in an open cut at the Croton Iron Mines. The work was done under Mr. Charles Vivian, contractor, between July 13, 1891, and Jan. 5, 1892:

Total cu. yd. rock and ore	9,295
Total number of drill holes	238
Total feet drilled	2,988
Average depth of hole, ft.	12.50
Ft. of hole per cu. yd.	0.32
Lb. of 52% dynamite per cu. yd.	0.44
	Per cu. yd.
Labor of all kinds	\$0.613
Explosives081
Steam for drills028
Repairs and supplies015
Total cost	\$0.737

This cost includes blockholing and slegding the ore to 7-in.

cubes, and the rock to 10-in. cubes. A percussive baby drill was used for blockholing. Mr. Vivian writes me that his original records have been lost, so that the rates of wages cannot be ascertained, but I think it is probably safe to assume that machine drillers received about \$2.75, and common laborers \$1.25 to \$1.50 per 10-hr. day.

Cost of Excavating Iron Ore in Tennessee. I am indebted to Mr. Daniel King, General Manager Pinkney Mining Co., Pinkney, Tenn., for the following data: Two 43-ton shovels (1½-yd. dippers) are worked in side cuts 25 ft. high. The ground is generally shaken up in front of the shovel, a 20-ft. hole, 12 to 16 ft. back of the face, being sprung with 2 to 5 sticks of dynamite and then shot with 2 to 4 kegs of powder. The ore, which varies from the consistency of hard pan to ordinary earth, is merely shaken up and not thrown down. The dump cars hold 77 cu. ft. level full and are generally heaped full with dippers, so a car holds not less than 3 cu. yd. of loose material, or say 2.4 cu. yd. place measure. Each shovel is served by two dinkey engines hauling trains of six cars. The wages paid per 10-hr. day are low, being as follows: 1 shovel engineman, \$3; 1 craneman, \$2; 1 fireman, \$1.25; 4 pit laborers, \$1 each; 2 dinkey enginemen, \$1.75 each; 1 superintendent (to two shovels), \$5; 60 to 100% should be added to these wages to compare this work with ordinary costs. There are no firemen or brakemen on the trains. The grade from the shovels to the dump is about 2% in favor of the load. The following was the cost of operating two shovels one month in 1903. Shovel No. 1 worked 171 hr.; No. 2 worked 161 hr.:

	Total	Per cu. yd.
No. 1. Excav. 5,513 carloads, wages	\$287.65	\$0.0135
Transporting 5,513 carloads, 500 ft. haul (one way), wages	83.60	0.0039
Drilling 272 ft. at 4 ct.	10.88	0.0005
Explosives	27.52	0.0013
No. 2. Excav. 3,362 carloads, wages	\$243.01	0.0114
Transporting 3,362 carloads, 1,500 ft. haul (one way), wages	60.13	0.0029
Drilling 239 ft. at 4 ct.	9.56	0.0005
Explosives	27.80	0.0013
Dumping, 8,875 carloads	142.27	0.0067
Track work	267.60	
Trackwork (nights) \$20 per day	75.87	} 0.0161
Blacksmith work	76.30	
Repair work	110.23	} 0.0190
Carpenter shop	37.70	
Renewal and repair supplies (\$11 per day)	196.39	}
Coal for shovel No. 1 at \$4.50 ton (17.2 tons).....	77.30	
Coal for shovel No. 2 at \$4.50 ton (16.2 tons).....	72.70	} 0.0070
Coal for 4 dinkeys (0.3 tons per dinkey per day).....	91.00	0.0043
Iron	23.85	0.0011
Lumber	37.39	0.0018
Oil (75 cts. per shovel day)	25.27	0.0012
Waste	0.90	0.0001
Total for 8,875 carloads or 21,300 cu. yd. " place measure "	\$1,984.92	\$0.0882

When washed, these 8,875 carloads yielded 7,633 tons of ore.
In 1902 during a month of 201 hr. the two shovels dug 10,703 carloads, at the following cost:

	Total
Excavating, wages	\$533.41
Hauling, wages	250.40
Drilling, 812 ft. at 4 ct.	32.48
Explosives	97.37
Dumping	194.99
Blacksmith work	84.11
Carpenter work	56.40
Repair work	137.28
Renewal and repair supplies (\$9 per day).....	182.46
Track work	185.10
Extra (night) labor	73.30
Fuel	247.40
Iron, \$24.60; lumber, \$29.23	53.83
Oil, \$28.40; waste, \$2.28	30.68

Total for 10,703 carloads or 25,687 cu. yd. place
measure \$2,159.21

When washed these 10,703 carloads yielded 7,573 tons of ore.

Wages of shovel crew are noted on the preceding page.

The best day's work with one shovel (a 43-ton Marion with 1½-yd. dipper) was Jan. 30, 1903. The work was in a side-cut, 25 ft. high and cost as follows:

Excavating (441 carloads), wages	\$12.75
Hauling (400 ft. one way), wages	3.50
Drilling 23 ft. at 4 cts.92
Explosives	1.66
Dumping (4 men probably)	4.50
Trackwork	18.00
Blacksmith work	3.08
Repair work	5.15
Carpenter work	3.00
Coal at \$4.50 ton	5.45
Iron and lumber (repairs and supplies).....	3.00
Waste and oil38

Total for 441 carloads \$61.84

When washed these 441 carloads yielded 450 tons of ore.

For the sake of comparison the following hand work in this ore will be interesting:

Loaders received 8 ct. per cu. yd. and earned \$1.25 to \$2 a day; common laborers received 10 ct. per hr. In a month of 235 working hours, with a haul of 800 ft. (one way), 600 ft. being a mule haul and 200 ft. by gravity, in a material not as hard as hardpan, and working to a face 16 ft. high, the cost was as follows:

	Total	Per cu. yd.
Digging 2,272 carloads = 3,635 cu. yd.	\$363.52	\$0.100
Hauling 2,272 carloads, 800 ft. one way	67.89	0.019
Drilling 273 ft. at 4 cts.	10.92	0.003
Explosives	36.67	0.010
Dumping	32.59	0.009
Repair and trackwork	40.68	0.011
Blacksmith work	3.10	0.001
Iron, \$2; lumber \$2.62	4.62	0.001
Oil, \$2.75; waste, \$0.18	2.93	0.001
Foreman (1 mo.)	82.50	0.017

Total for 2,272 carloads

cu. yd. \$625.42 \$0.172

When washed, these 2,272 carloads yielded 2,488 tons of ore. These cars were smaller than the cars hauled by the engines, and they held 2 cu. yd. of loose material, or 1.8 cu. yd. place measure.

Costs of Pit Mining Near Rochester, N. Y. The following data relative to the cost of iron mining at the mines of the Furnaceville Iron Co., near Rochester, N. Y., are interesting because the ore body is very thin compared to the heavy overburden. For the information upon which this article is based, I am indebted to a paper by Mr. Edwin Higgins in *Engineering and Mining Journal* (abstracted in *Engineering and Contracting*, Jan. 27, 1909). In the workings to which the cost data apply, the overburden is about 20 ft. thick, 10 ft. of which is limestone, more or less shaly, the upper part being soil and glacial material. At first the ore was only worked where the overburden was the lightest. Picks and shovels and wheelbarrows were used to remove the dirt. About 20 years ago two Boston steam shovels manufactured by the John Souther Co., of Boston, Mass., were put to work at the ore stripping. These shovels have been operated during this period more or less continuously and they were still (1909) used for special work.

These two shovels worked one behind the other stripping a width of 60 ft., each shovel taking 30 ft. The great improvement in this work has been in the manner of handling the excavated material, and in the use of one modern steam shovel in doing the stripping.

For this purpose there is now being used a Vulcan Giant steam shovel of 2½ cu. yd. dipper capacity. This shovel is capable of making a cut 56 ft. wide, but at present it takes out a cut only 40 ft. wide and 20 ft. deep. This shovel loads the material into self dumping skips of 5 cu. yd. capacity that are operated on an inclined conveyor, which is described in detail on page 512 of Chapter XII.

The overburden is blasted before being excavated by the steam shovel. For this purpose two cable drills, mounted on wheels, and with their own boilers, manufactured by the Austin Manufacturing Co. of Cleveland, Ohio, are used to drill the holes. The holes, 6 in. in diameter, are drilled on 15-ft. centers and extend a few inches into the ore. Each drill requires one man and burns about 400 lb. of coal in 10 hr. The cost of operating a drill per day of 10 hr. is:

	Per Day
Labor	\$2.50
Coal	0.70
Supplies (estimated)	0.30
Plant (estimated)	1.00
Total	<u>\$4.50</u>

Each drill puts down an average of 4 holes per day, or a total

of 80 ft., thus costing about 5.6 ct. per ft. For each cubic yard of material excavated 0.09 ft. of hole was drilled, making a cost for drilling of 0.5 ct. per cu. yd.

The holes are shot with 40% dynamite, using on an average 65 lb. of explosives to the hole, worth 13 ct. per lb., thus using 0.3 lb. per cu. yd., costing 4 ct.

The steam shovel working under favorable conditions, with machinery for promptly handling the excavated material, handles a large yardage during the 10-hr. working day. Work is done throughout the entire year, only stopping for the most severe weather. The shovel excavates from 1,200 to 1,700 cu. yd. of overburden per day, or an average of about 1,500 cu. yd.

The cost of operating the steam shovel per day is as follows:

	Per Day
Foreman	\$3.50
Shovel runner	2.50
Cranesman	2.00
Fireman	1.75
8 tons of coal at \$3.50	10.50
Oil and supplies	0.50
8 laborers at \$1.30	10.40
Plant (estimated)	6.00
Total	\$37.15

This gives a cost for excavating and loading with the shovel of 2.5 ct. per cu. yd.

The total cost per cubic yard for stripping is as follows:

	Per cu. yd.
Drilling	\$0.006
Explosives	0.040
Loading	0.025
Conveying and dumping	0.015
Total	\$0.086

No allowance has been made for general expense. Although the wages paid are somewhat smaller than those paid for excavation work by contractors, yet the total cost for this class of work is very low.

There are some interesting facts in connection with the breaking up and excavating of the ore. The stripping disposes of the waste material with the exception of about 8 in. of limestone capping over the ore. This capping adheres to the ore and is usually blasted, although it may sometimes be removed with crowbars.

Holes are drilled through the ore at 3-ft. centers, and are shot with $1\frac{1}{2}$ to $1\frac{3}{4}$ sticks of 15% dynamite, which costs 9 ct. per lb. This is equivalent to drilling of 4 ft. of hole for each cubic yard of ore excavated, and $1\frac{1}{4}$ lb. of dynamite used per cubic yard. *The ore breaks in slabs of varying sizes, the large pieces being broken with sledges. The broken ore is loaded into tubs or skips*

by a small steam shovel, and hoisted by means of a derrick into railroad cars on the bank. For the loading of the skips a Vulcan Little Giant Shovel with a dipper of 1½ cu. yd. capacity is used. It requires a crew of three men and burns 1½ tons of coal per day of 10 hr. This shovel has excavated as much as 300 tons of ore per day. The ore weighs 225 lb. per cu. ft. or 3 tons per cu. yd., thus giving a yardage handled per day of 100 cu. yd. This output when it is considered as working in hard material against a breast less than 3 ft., is very good. The approximate cost of breaking up and loading the ore per day, assuming an output of 30 cu. yd., is as follows:

	Per Day
Foreman	\$ 3.50
Drilling	12.00
Explosives	3.37
Shovel Crew:	
Shovel runner	2.50
Cranesman	2.00
Fireman	1.75
1¼ tons of coal at \$3.50	4.37
Plant (estimated)	5.00
Total	\$34.49

To this must be added the daily cost of the derrick, which is described more fully on page 511, amounting to \$9.87, and the cost of 6 laborers at \$1.30 each, a total of \$7.80, which makes a grand total of \$52.16 for breaking up and loading.

This gives a cost per cubic yard as follows:

	Per cu. yd.
Foreman	\$0.118
Drilling	0.400
Explosives	0.112
Loading	0.354
Derrick Handling	0.266
Laborers	0.260
Plant	0.200
Total	\$1.738

Mining Mesabi Iron Ore. The largest operations in iron ore mining are located in St. Louis County, Minnesota, a region which is known generally by the title Mesabi. In this section, there are three general methods of mining followed: (1) Underground minings; (2) open-pit mining; (3) milling pit mining, a combination of the first two methods. Open-pit mining reaches its highest development in this locality.

For average work, the comparative cost of open pit and underground mining are shown by the following:

	Per cu. yd.
Stripping ordinary glacial drift	\$0.30
“ “ paint-rock	0.30
“ “ broken taconite	0.75
“ “ solid “	1.00
Steam shovel mining, ordinary ground	0.83
Underground mining, ordinary conditions	1.50

On the basis of these figures, the cost of mining a column of ore 1 sq. yd. in area, and 36 ft. deep, with an overburden 65 ft. deep, would be about as follows:

Underground mining 36 ft. high	\$18.00
Open pit mining:	
Stripping 50 ft. of glacial drift	\$5.00
Stripping 15 ft. of solid taconite	5.00
Steam shovel mining	3.60
	<u>13.60</u>
• Balance in favor of open pit mining	\$4.40

Open pit mining is usually economical when there is not more than 1 cu. yd. of overburden to each ton (about 0.5 cu. yd.) of ore (1 cu. yd. of hard slate and taconite are equivalent to about 3 cu. yd. of overburden), and when the maximum stripping depth is less than 150 ft. Naturally, as a pit becomes deeper and track grades increase, open pit mining must necessarily cease.

Bucyrus, Marion and Atlantic steam shovels, generally in size from 60 to 90 tons, and occasionally weighing 110 tons, are used. The smaller machines are employed in stripping, stock pile loading, and cleaning-up work, the largest sizes for ore excavation. Standard railroad cars of 100,000 lb. capacity are used for conveying the ore, and 4 to 20-cu. yd. dump cars for hauling overburden. The locomotives employed range from 20 to 100 tons in weight and are of the side-rod and Shay type, the latter type being preferred on steep grades. The track system used depends upon the shape of the property and the depth of the cut; those developed on a spiral are preferred to switch-back systems.

The average output of shovels in stripping work is 1,800 to 2,200 cu. yd. per shift for a 60-ton machine and 2,000 to 2,500 cu. yd. for a 90-ton shovel. Good outputs are 3,000 cu. yd. for a 60-ton and 3,800 cu. yd. for a 90-ton shovel. In ore, a 90-ton shovel should average 60 cars (960 cu. yd.) per shift for the season. Reference to the chapter on loading with steam shovels will show that the output of a 70-ton machine was 892 and of a 90-ton shovel 1,350 cu. yd. High records for a 10-hr. shift are as follows: 110-ton shovel, 175 cars; 90-ton shovels, 180 cars; 60-ton shovel, 100 cars. Stripping done by contract costs from 27 to 30 ct. per cu. yd. Actual costs by force account on one property was 17 to 22 ct. Mining ore costs on an average of about 15 ct. per ton. The rates of wages up to 1913, paid steam shovel and train crews were as follows, but have since been increased: Shovel runner, \$5.97; craneman, \$4.04; fireman, \$2.50; locomotive runner, \$3.75; fireman, \$2.50; brakeman, \$2.00 to \$2.75; pitman, \$2.35; trackmen and laborers, \$2.10 per 10-hr. shift.

Mr. D. E. Woodbridge, in the *Engineering and Mining Journal*, Feb. 9, 1905, gives some records in open pit mining in this region. He states that the stripping weighs from 1 to 1.25 tons per cu.

yd., and the ore weighs about 2 tons per cu. yd. Some of the records for one day's work are very high, but a shovel crew that will maintain an output of 3,000 tons (1,500 cu. yd.) per day of 10 hr. for an entire season is exceptional. The following are some of the best records.

Location	Burt Mine	Mountain Mine
Date	Aug. 6, 1903	Aug. 13, 1903
Shovel	Marion 91	Marion 91
Weight of shovel	93 tons	93 tons
Size of dipper	5 tons	5 tons
Long tons	5,096	4,826
Location	Mahoming Mine	Stevenson Mine
Date	1902	July 28, 1904
Shovel	Bucyrus	Marion 98
Weight of shovel	65 tons	100 tons
Size of dipper	3.5 tons	6 tons
Long tons	4,100	7,109

These shovels loaded into 35-ton cars, and the dippers had to average 100 scoops per hr. for 10 hr. The records show costs of stripping as low as 15 ct. per cu. yd., and for very hard work 19 ct. per cu. yd. Contract prices average about 30 ct. per cu. yd. If the ore body is half as thick as the stripping, the removal of 1 cu. yd. of stripping will uncover 1 ton of ore. As a rule the ore is loaded and hauled out of the mine for less than 10 ct. per ton, thus making the average total cost per ton, including stripping, about 40 ct.

The cost of pumping is considerable: In one large open pit mine pumping averaged to 1,600,000 gal. daily for one year. The output was 1,000,000 tons of ore, which gives the amount of water pumped as 1.6 gal. per day per ton mined.

Blasting preliminary to steam shovel work is generally done by a special crew. In overburden, holes are drilled by hand hammer drills, and in ore with hand jumper (churn) drills. Where the banks are high, "gopher holes" are driven. Drilling in stripping costs 8 to 15 ct. per ft. of hole. In ore, 2 to 4 men will drill an average of 60 ft. and a maximum of 120 ft. per 10-hr. shift, at a cost of 7 to 10 ct. per ft. Gopher holes cost 10 to 15 ct. per ft. of hole for ore, and 7 to 10 ct. for stripping; 20 to 25 ft. per shift are generally driven. The holes are sprung with dynamite and blasted with black powder.

Navigation on the Great Lakes ceases during the winter season, and therefore enormous quantities of ore are stored through four or five months of the year in huge stock piles. These stock piles are formed in various ways. The two systems in common use are the Michigan and Minnesota system. In the Minnesota method, the stock pile is started at the end of a short trestle and is built out with end dump cars. In the Michigan system a long trestle is used. At the Negaunee Mine, a permanent trestle of iron and steel has been built. With long wooden

trestles, the timber loss per year is from 12.5 to 25%. One trestle 42 ft. high, costs \$3.00 per lin. ft.

The labor cost of stock piling is high, and the power cost is low. The total costs vary from 2 to 7 ct. per ton; where 1,000 tons per day are stocked the cost is 2 to 3 ct.; where the output is small it is 5 to 7 ct. per ton.

The ore in stock piles requires reloading with steam shovels. According to Table LXI 1,251 cu. yd. are loaded by 70-ton shovels and 2,728 cu. yd. by 90-ton shovels per shift.

Stripping an Iron Mine. A comparison of hand and machine drilling in stripping 175,000 cu. yd. of overburden at the Portland Mine, Michigamme, Mich., is furnished in an article published in the *Mining and Engineering World and Engineering and Contracting*, Aug. 16, 1911. This work was carried on by Hoose & Person, contractors, for the Niagara Iron Mining Co. The pit is, roughly, 750 x 250 ft. and varies up to 45 ft. in depth. The ore body lies at an angle of 30 deg. and its long dimension coincides in direction with that of the pit, necessitating benches or terraces on the foot-wall side. Of the 175,000 cu. yd. of stripping, about two-thirds is rock and hardpan, and one-third sand and boulders. The work was begun a year ago and except during the winter has furnished employment for two steam shovels, two locomotives and about 80 men.

Drilling. Drilling was necessary in the hardpan and the rock. The hardpan, consisting of pebbles cemented with iron oxide and siliceous material, was in some cases 15 ft. in thickness, difficult to drill as well as to blast, being usually tougher than the rock. The rock overlying the ore was a siliceous slate grading into a lean limonite, differing greatly in hardness and ease of drilling. Drill holes were commonly 10 ft. in depth, drilled vertically downward, and placed from 6 to 10 ft. apart, and a like distance back from the face. In unusually hard ground horizontal holes carrying water were drilled into the face of the slice, and were fired at the same time as the vertical holes.

A good deal of the rock was broken by hand drilling before any machine drills were purchased. It was found that to keep the steam shovel busy required 10 gangs of three men each, or thirty men. One occasion it took three men an entire shift to drill one 10-ft. hole. It was the custom for two men to strike with hammers, and one man to twist the steel, which was single bitted. When 8-ft. depth was attained, it was usually better to lay aside the hammers and use a jumper (churn) drill for the remaining 2 ft. The jumper was of ordinary drill steel sharpened at the two ends, and with three men manipulating it dealt a stronger blow than the 7-lb. hammer could effect upon the long steels.

After the stripping was well along machine drills were installed, and the results were excellent. The 30 men per shovel necessary for hand drilling were replaced by three percussive drill machines and six men, making a considerable reduction in labor cost. The drill used was a 3 $\frac{1}{8}$ -in. tappet valve mounted on a heavy tripod, with air pressure at 75 lb. Such a heavy type of powerful drill was selected because a gang of men could be summoned to lift tripod and machine together to a new hole.

In the deeper holes, where the rock chippings gave trouble in making the drill stick, single bitted steel was tried in the machine, because this style bit would force its way through sludge to better advantage, but the men did not take to the innovation readily, and it was abandoned.

"Coyote or gopher holes" gave good results in cases where there was opportunity for heavy blasting. A "coyote hole" was put into the face 15 or 20 ft., and crosscuts put to right and left for 6 or 8 ft. At the end of the crosscut a shallow depression was made, in which 10 to 15 kegs of black powder were deposited. This was covered with dirt and tamping shoved in, filling the entire working for several feet. If not enough tamping was used the charge would shoot out like a cannon, and break no ground at all.

The "coyote holes" were put in about 20 ft. apart, and would lift about 15 ft. of rock. Three or four were fired at once, and when properly tamped, they broke the ground nicely, without throwing the fragments. On one occasion a misfired hole went off just as the miner had returned to examine the fuse, but aside from throwing him down he was not injured.

Forty per cent dynamite was used for "shaking" the holes; black powder was employed for most of the blasting where the ground was dry; and in wet holes, 27% dynamite was found to give a dull, slow action similar to that of black powder.

Cost of a Cable Drill Blast in Copper Ore. (*Engineering and Contracting*, Dec. 2, 1908.) On May 22, 1907, a large blast was made in the steam shovel workings of the Boston Consolidated Co., at Bingham, Utah. The material was a copper bearing porphyry. The steam shovels, excavating the ore, were working on the main point of rock which projects from the regular center of the mountain. Cuts had been made on both sides of this point, and a blast was made to straighten out the work.

A hole was put down 80 ft. with a No. 3 Keystone traction cable well drilling machine, using a 5 $\frac{1}{8}$ -in. bit. It was placed so that there was about 60 ft. of powder on the bottom of the hole. The hole was sprung with three boxes of 40% Hercules dynamite, and then loaded with two tons of the same grade of

powder. By surveys, before and after, it was shown that 12,000 cu. yd. of material were shattered so it could be excavated. The cost of the blast was as follows:

80 ft. of drill hole at 58 ct. per ft.	\$ 46.40
150 lb. dynamite for springing at 10½ ct.	15.75
4,000 lb. dynamite at 10½ ct.	420.00
Fuse and caps	1.20
Labor handling powder and incidentals	17.25
Total	\$500.60

This gives a cost per cu. yd. of 4.1 ct. for loosening this rock. For the springing 1¼ lb. of dynamite was used for every 100 cu. yd. of material loosened, while for the entire blast about 0.35 lb. of dynamite was used for each cu. yd., which is an economical blast, in spite of the fact that in loading the hole a little too much powder was put in the collar of the hole, thus throwing out some of the material, when it was only wanted to shatter it. This could have been prevented by springing the hole a little more, thus giving a larger chamber for the powder and keeping it out of the collar of the hole altogether.

Cost of Excavating Gneiss. I am indebted to Mr. John J. Hopper, civil engineer and contractor, for the following data, part of which originally appeared in the magazine, *Stone*. The work involved the excavation of 29,295 cu. yd. of gneiss (or mica schist) at One Hundred and Twenty-seventh street, New York City. The drilling of the main holes was done with four 3½-in. Ingersoll percussive steam drills, and two percussive "baby drills" were used for drilling block holes. The average height of the lifts was 12 to 15 ft., and the cut ranged from 2 to 63 ft. deep. Hand drillers and sledgers received \$2 per 10-hr. day; laborers handling stone and loading wagons received \$1.50; one of the machine drillers received \$3, and the rest of the drillers received \$2.75 a day. The baby drills were used only on the largest pieces thrown down by the blast; the ordinary sized stone from the blast was broken up by hand-drilled holes and by sledges to sizes suitable for building rubble foundation walls. A good deal of the stone was piled up during the winter until it could be sold. The drilling part of the plant cost \$1,800; the boilers, derricks, hoists, etc., cost \$1,080; 40% dynamite, costing 20 ct. per lb., was used. There were 18,433 ft. of main holes drilled (not including block holes) in excavating 29,295 cu. yd. of solid rock. The total cost of the work, including the plant, cartage, sledging, etc., was \$52,635. The itemized cost was as follows:

	Per cu. yd.
Foremen and timekeepers	\$0.080
Enginemen and drillers	0.109
Sledges	0.383
Derrickmen and helpers	0.096

	Per cu. yd.
Labor, loading, etc.	\$0.247
Hand drillers	0.117
Blacksmith and helper	0.053
Hauling away in wagons	0.405
Explosives	0.098
Coal, coke, oil, etc.	0.080
Repairs to drills	0.010
Repairs to boilers, derricks, etc.	0.012
	1.670
Total per cu. yd.	\$1.670

Mr. Hopper informs me that in sound rock where 20-ft. holes could be drilled, a drill would average 70 ft. in 10 hr.; but in shallow drilling the drills would frequently not average over 25 ft. each.

Cost of Gneiss Excavation for Dams. Mr. J. Waldo Smith is authority for the statement that on several dam jobs done under his direction, near New York City, it had cost the contractors \$1.65 per cu. yd. to excavate gneiss in open cuts, when wages of common laborers were \$1.65 ct. per 10-hr. day. At Catona it had cost the contractors \$3.50 per cu. yd. to excavate gneiss in the foundation for the dam, where no blasting was allowed. At Boonton, N. J., under similar conditions, it had cost \$3.30 per cu. yd.

Cost of Chamber Blasting for a Rock Fill Dam. Mr. Robert B. Stanton, *Transactions American Society of Civil Engineers*, V. 35 (1896), p. 101, gives the following data on the cost of a rock-fill dam built in 1895. Quarrying was done by exploding several tons of powder in drifts and shafts (chamber blasting), thus breaking 30,000 cu. yd. of rock at one shot. The amount of rock in the dam was 120,000 cu. yd. as measured in place before blasting. The plant consisted of a cableway and three derricks on the dam, cost of plant was \$12,000. Common labor cost \$1.75 a day; coal \$10 a ton. The cost per cubic yard (measured in place before blasting) was:

	Per cu. yd.
Quarrying	\$0.06
Loading buckets by hand, including breaking larger rocks with powder	0.20
Hoisting and conveying	0.06
Placing rock on dam	0.03
Cost of plant (\$12,000 over 120,000 cu. yd.)	0.10
	0.45
Total	\$0.45

This includes repairs to plant and first cost of plant.

Blasting Rock for Dam Filling. (*Engineering and Contracting*, Oct. 9, 1907.) In the construction of a rock-filled dam for the Canyon Creek Reservoir in Utah, the portion of the dam between the face walls and the walls next the core was filled with rock dumped in, with all the spaces carefully filled. The rock for all this work was procured by blasting it from the cliffs on

each side of the canyon. The blasting down of the rock was exceptional in that the conditions were unusually favorable. The Canyon on the south side, from which the main part of the rock was blasted down, was cut with seams horizontally and vertically, dividing it into blocks from 20 to 30 ft. square, the horizontal seams sloped towards the Canyon at an angle of about 40 to 60 deg., so a blast put in 20 or 30 ft. from the face would throw down large masses of rock that averaged 130 to 150 cu. yd. to each blast. The cost of drilling by hand was as follows:

	Per Day
3 men at \$2.50 per day	\$7.50
Sharpening tools	0.32
Drill carrier	0.25
Wear on tools	0.41
Foreman	0.50
Total, 12 ft. drilled at 75 ct.	\$8.98

The cost of blasting was as follows:

	Per Blast	Per cu. yd.
Average depth of holes 18 ft., drilled at 75 ct.....	\$13.50	\$0.10
Springing and cleaning out	1.90	0.01
250 lb. black powder at 7 ct.	17.50	0.13
20 ft. fuse, at ½ ct.10	0.00
Loading and firing	1.50	0.01
Total, 135 cu. yd.	\$34.50	\$0.25

CHAPTER XV

RAILROAD ROCK EXCAVATION AND BOULDER BLASTING

General Considerations. Excavation in railroad work differs somewhat from quarry work and from canal work. In quarry work the rock is intended for some use which determines the size of the pieces and the manner of blasting. In canal work the muck or spoil is usually dumped on one side of the cut, whereas in railroad work, except in side hill cutting, the spoil is generally carried along the right of way, sometimes for long distances, to be used in embankments. In railway work the size of the blasted rock pieces is limited only by the means available for handling them. Larger stones can be handled with derricks than with steam shovels.

Spacing of Holes. In the limestone on the Chicago Canal, not much of which was loaded with steam shovels, the holes were usually 12 ft. deep and placed in rows about 8 ft. back of the face and 8 ft. apart. These holes were charged with 40% dynamite.

In a railway cut through sandstone the holes were 20 ft. deep, 18 ft. back from the face and 14 ft. apart in the row. These holes were "sprung" three times, and each hole charged with 200 lb. of black powder.

In granite quarried for rubble for dam work, I have had to place the holes $4\frac{1}{2}$ to 5 ft. back of the face and the same distance apart, the holes being 12 ft. deep, about 2 lb. of 60% dynamite being charged in each hole. On railway work in the Rocky Mountains about the same spacing was found necessary in granitic rock that was to be broken up into chunks that a steam shovel could handle.

The term "thorough cut," or "through cut," is used to designate an excavation through a hill (Fig. 141), in distinction from an excavation along the side of a hill, or "side hill cut" (Fig. 142-B).

Cost of Railroad Excavation in Tennessee. For the following data I am indebted to Mr. Daniel J. Hauer:

In railroad work it is difficult to keep separate records of the cost of excavating earth, loose rock and solid rock. Specifications differ as to classification of excavated materials and engineers differ in their interpretation of specifications, all of which

tendent, time keepers, blacksmith and night watchmen; but the cost of these items was 6% of the total cost, being distributed as follows:

Superintendent	\$975.50
Blacksmith	586.80
Time keeper	584.85
Night watchman	457.50
Total	\$2,604.65

Each cut was opened up with wheelbarrows, and when the extreme haul for these became 50 ft., either dump carts or cars were substituted. The cars were operated on wooden rails, made of 2 x 4-in. scantlings, either of oak or beech. The entire cost of these tracks is included with labor, except the cost of the two by fours, which were used several times, these being only 10,000 ft. B. M., bought at a cost of \$10 per M. These tracks worked well except in dry weather, when it was necessary to have a man pour water on the rails, or else the cars were frequently derailed. On sharp curves and at switches, guard rails were used.

The cost of trimming and dressing up the work is included in each case, but it may be of interest to consider some features of it separately. All cuts were excavated a foot below the cross-section stakes, and then this foot was filled back, leaving a ditch on either side of the cut wherever the plans called for one. If this back filling was made from the cut no payment was made for the work; but if it was done with material from a borrow pit, it was paid for as earth. Blue prints were furnished for this work and stakes were driven to grade, and the work was supposed to be done within 0.05 ft. This method saved the railroad company a little money in ballasting, but it added materially to the cost of dressing up for the contractor. He was allowed 6.6 cu. yd. of earth on a 10° curve (the maximum curve used) per 100 ft. of roadbed, for putting on this elevation. On lighter curves a less amount was allowed. In nearly all cases the cuts were taken out a foot below grade, and the embankments were high; yet to dress up 6,300 lineal ft. of roadbed cost \$1,226.14, making a cost of 0.97 ct. per sq. yd., or 1½ ct. per cu. yd. of material moved within the 6,300 ft. This cost is excessive, especially when slopes of cuts have been trimmed as work progresses, so that only the roadbed has to be dressed. Such work should have been trimmed and dressed for less than ½ ct. per sq. yd.

Table LXVII gives the yardage and the cost of excavating each cut; and Table LXVIII gives the cost per cubic yard for each class of material. It should be remembered that wages were only 13½ ct. per hr. for laborers, that two mules and a driver were 30 ct. an hr. To the costs given in the tables 6% should be added for superintendence and general expenses. The "next-

age haul" was measured on the profile from center of gravity of cut to center of gravity of fill.

NOTE. In the last column the letters denote as follows: D means by dump carts; C, dump cars; C and D, both dump carts and cars for about equal length of time; W, wheelbarrows.

TABLE LXVIII

Case	Explosives	Labor and Foremen	Teams, etc.	Total	Yardage			Total
					Earth	Loose Rock	Rock Solid	
I	\$ 96	\$ 982	\$404	\$1,482	2,491	2,281	1,644	6,416
II	11	167	46	224	717	517	1,234
III	266	1,619	273	2,158	2,619	2,831	2,435	7,885
IV	34	278	36	348	347	502	849
V	50	359	112	521	1,953	596	2,549
VI	19	189	36	244	1,295	408	607	2,310
VII	185	1,086	196	1,467	903	1,664	1,169	3,736
VIII	1,003	2,483	454	3,940	176	177	6,568	6,921
IX	322	1,659	48	2,029	815	5,980	6,775
X	397	1,924	346	2,667	2,043	1,504	2,934	6,481
XI	222	883	225	1,330	764	989	2,089	3,822
XII	1,090	4,978	777	6,845	868	1,117	11,676	13,661
XIII	23	327	350	400	600	1,000

Cost
per cu. yd.

Case	Earth	Loose Rock	Solid Rock	Average Haul, Ft.	Method of Hauling	Time of Year.
I	11.0	21.0	43.1	992	D	Nov., Jan., Apr., to July.
II	12.8	25.6	110	D	Summer.
III	12.3	24.6	46.8	350	C	Aug. to Feb.
IV	26.7	50.8	200	D	Aug.
V	16.6	33.2	225	D	April and May.
VI	5.5	11.0	21.1	425	D	Aug.
VII	17.0	34.0	64.0	450	D	Winter and Spring.
VIII	15.5	31.0	58.7	300	C & D	Aug. to Dec.
IX	16.5	31.8	50	W	Jan. to Mar.
X	16.5	33.0	62.5	475	C & D	Aug. to July.
XI	12.5	25.0	47.5	250	Summer
XII	14.4	28.8	58.4	610	C	Aug. to Aug.
XIII	21.8	43.7	50	W
Average	13.3	26.7	50.6

The materials encountered in these 13 cuts were as follows:

Case I. Shale and slate ledges across part of cut, large and small sandstone boulders, stiff clay and earth. Work was stopped in wet weather on account of slides. Work was in November, January, April to July.

Case II. Disintegrated rock, sandstone boulders, fire clay and earth. Work in summer.

Case III. Slate rock in masses, shale, sandstone boulders and earth. A thorough cut first made, then borrowed from the sides. One mule pulled two cars. August to February.

Case IV. This work consisted in reducing a slope that was $\frac{1}{4}$ to 1, making it 1 to 1. Sandstone and rotten sandstone; the latter pulverized on being shot. August.

Case V. This was a borrow pit of disintegrated sandstone and average earth. Some of this sandstone should have been classified as solid rock. April and May.

Case VI. Slate in masses, fire clay, fire clay shale and debris from old slides consisting of boulders and earth. One foreman handled two gangs. August.

Case VII. This was a borrow pit, material being same as in Case VI. Winter and spring, August to December.

Case VIII. Solid gray sandstone (seamy) and a small amount of earth and loose rock at each end. Thorough cut.

Case IX. This was a borrow pit and a continuation of the sandstone ledges of Case VIII. January to March.

Cases X and XI. Mountain debris, consisting of sandstone boulders (large and small) fire clay, cemented gravel and earth, material always wet and heavy to shovel; slides were frequent in winter. August to July for Case X, and summer for Case XI.

Case XII. Half of this cut was solid sandstone. At the other end was slate, fire clay shale, disintegrated shale, clay and large sandstone boulders. The cut was 27 ft. deep at deepest point. In the winter the shale slid on the fire clay shale, bringing down several thousand yards of slides into the cut. For five months (December to April) the shovelers stood in mud and water above their ankles. Material would frequently run out of the cars on the way to the dump. August to August.

Case XIII. This was a trench 6 ft. deep, 20 ft. wide on top, 15 ft. wide on bottom, dug to carry a creek.

It is not possible in all cases to compare the cost of one cut with another, but from the figures given several deductions can be made. In Cases X and XI the materials excavated were similar. There was a difference in the length of the haul, but the great difference in the cost of the work can be attributed to the time of the year that the excavations were made. Case XI was worked entirely during the summer, while Case X was worked during both summer and winter. If both cuts had been made in the summer months their costs should have been approximately the same, the slight difference in cost of haul counting in favor of the cut in Case XI.

A valuable lesson can be learned from Cases VIII, IX and XII. In these the greater part of the material was sandstone, being classified as solid rock. In two cases the work consisted of thorough cuts and one a side hill borrow.

In VIII the cost of explosives was a little more than \$1,000, while with nearly twice the yardage in XII the cost of the ex-

plosives was not \$100 more. The difference in the cost of the teams in the two cases is readily accounted for when the lengths of the average hauls are compared.

The great cost of powder in Case VIII can to a great extent be attributed to the waste of incompetent foremen. The majority of boulders were "mud capped" instead of being "blocked," or having the charge of dynamite placed under the rock. In all, seven different foremen worked in this cut, four of whom were discharged as incompetent; but the damage was then done and the money in part lost. All thorough cuts were shot with Judson powder, as the rock is broken better than when black powder is used, and much "blocking" of boulders is prevented. Better results can always be obtained with Judson, except where it is desired to waste, when black powder should be used. In Case VI Judson powder pulverized all the solid rock, so that no "blocking" was needed, as all the material was easily worked by hand. In Case IX, as it was very important that none of the material should be wasted, Judson powder was used, and less than \$50 was spent in breaking up boulders. The cost of explosives in the entire borrow was only 4¼ cts. per cu. yd. of rock moved. In comparing all the cost items of this case with Cases VIII and XII the striking difference in the cost of side hill work and thorough cuts can be seen.

It was found necessary to widen and lower to grade certain cuts that had been left incompleated by another contractor. The cost of such skimming work is high, as is well shown in Table LXIX.

TABLE LXIX
Cost per Cu. Yd.

Case.	Cu. Yds.	Haul, Ft.	Explosives.	Labor.	Foreman.	Hauling.	Miscel.	Total.
XIV.	626	225	\$0.098	\$0.384	\$0.108	\$0.093	\$0.001	\$0.684
XV.	484	150	.108	.488	.122	.081	.001	.800
XVI.	415	325	.095	.334	.116	.091	.024	.660

Case XIV was a breast 10 ft. deep on the side of a cut in hard blue sandstone.

Case XV was the widening of both slopes of a cut in red sandstone and the excavation of the bottom.

Case XVI was the excavation of the bottom of a cut in blue sandstone; at no place was the face excavation more than 5 ft. deep; 1½ yd. dump cars were used.

In cases XIV to XVI laborers received \$1.50 per 10 hrs., and foremen \$3 to \$3.50; one driver and two mules on two carts

were rated at \$3.50 a day; powder was \$1.20 a keg, and dynamite (40 per cent.) was 10 ct. per lb.

Methods and Costs of Excavating Granite in Open Cuts on the Grand Trunk Pacific R. R. Mr. George McFarlane, engineer and contractor, gives (*Engineering and Contracting*, Nov. 27, 1907) the following valuable data relative to the rock excavation that he did as a contractor on the Grand Trunk Pacific R. R. The contract covered some rock tunnel work, approaches to the tunnel, and some open cuts. The work described will be limited to the open cuts and the tunnel approaches.

The Grand Trunk Pacific R. R. was being built from Quebec to Winnipeg by the Dominion Government. The J. D. McArthur Co. of Winnipeg had the contract for grading the 276 miles between Superior Junction and Winnipeg. The 80 miles of this division lying north of the Lake of the Woods was nearly all rock work and was estimated to cost about \$100,000 a mile to grade. Nearly all the rock work was sublet to small contractors and "station men." Practically none of the subcontractors kept any costs of their work. Fully three-quarters of the rock cuts were sublet to gangs of "station men" at prices ranging from \$1.15 to \$1.35 per cu. yd. The station men were charged \$4.50 a week for board, \$5.50 a day for a team and driver, \$11.50 a box for 60% dynamite and \$2.75 a keg for black powder and other supplies in proportion. They were also given free cars and rails, but no overhaul, or, if they used pole tracks and stone boats, which they furnished themselves, they were allowed the customary 1 ct. per cu. yd. per 100 ft. as overhaul beyond the 500-ft. free haul limit.

The rock cuts were 20-ft. bottom, sloped back 3 in. to the foot, but most of the cuts broke wider than the slope stakes, the overbreak yardage running from 10 to 40%. Overbreak was usually paid for at the same price as the regular section, but the commission left it to the engineers whether the contractor should be allowed "overbreak" or not.

One gang of 10 station men took out a 7,000 cu. yd. rock in one winter at \$1.20 per cu. yd. and each man cleared, over all expenses, \$4.60 per day and board. Most of the station gangs did not make over \$2.50 to \$3.00 per day, and received from \$1.30 to \$1.35 per cu. yd.

The large cuts were mostly sublet to contractors who furnish their own equipment and camp outfit. They received from \$1.40 to \$1.50 per cu. yd. All blasting material was bought from the general contractor at the following prices: Dynamite, 40%, \$9 per 50-lb. box; 50%, \$10; 60%, \$11; black powder, \$2.50 per 25-lb. keg; fuse, 90 ct. per 100 ft.; caps, 90 ct. per box.

lead wire, \$1.75 per 100 ft.; electric fuses, \$3 per 100 for 4 ft. lengths and \$.50 per hundred extra each 1 ft. over 4 ft.

Hand Drilling. On his own work Mr. McFarlane used steam drills in all the large cuts, while in the smaller cuts hand drills were used. With hand drills, holes as deep as 30 ft. were put down. Steel, 1 in. in diameter, was used to make the drills, which were gaged to 1 $\frac{3}{8}$ in., this size drill being used for the entire depth of the hole. The hand drillers worked 3 men in a gang. In starting the hole, and until it reached a depth of about 6 ft., 2 men did the striking and one man held the drill. In drilling holes to a greater depth all three men used striking hammers, the rebound and jumping of the drill turning it enough to keep the hole fairly round. The rocks encountered on this work are hard granite, traps and diabase of the Laurentian and Huronian system.

Hand drillers, when working by the day, were paid \$2.25 for 10 hr., but, when paid per foot drilled, received 45 ct. This price does not include sharpening or carrying steel to the shop. In drilling block holes, every hole less than 1 ft. in depth was counted as being a foot. The average footage of hole per gang of 3 men per day was 30 ft. The cost of drilling, including sharpening bits was 48 ct. per ft.

Machine Drilling. For deep holes the drill steels are made up for 2-ft. depths. The starters are gaged 3 $\frac{1}{2}$ in., the gage being dropped $\frac{1}{8}$ to 3-16 in. for each succeeding steel so as to finish the hole to about 1 $\frac{1}{4}$ in. The bits are forged with long, heavy shoulders and very little clearance, to reinforce the corners of the cutting edge and prevent excessive wear in the gage. The last two or three drills of the set are usually fitted with blunt chisel bits.

Steam drill runners were paid \$3.75 per day of 10 hr. and helpers \$2.25. On railroad work the cost of running steam drills is necessarily high, as, ordinarily, only one or two drills can be operated from one boiler.

The daily expense of working one 3 $\frac{1}{8}$ -in. steam drill from a boiler was as follows:

1 drill runner	\$ 3.75
1 drill helper	2.25
1 fireman	2.50
$\frac{1}{2}$ blacksmith	1.87
$\frac{1}{2}$ blacksmith helper	1.13
1 cord wood	2.25
Coal	0.30
Repairs and oil	0.38
Total	<u>\$14.43</u>

This does not include interest, depreciation and general expense. Some individual records of drills were as follows:

A baby Rand drill 2¼-in. cylinder put down 5 "pop holes," totaling 26 ft. in 5 hr.

A 3½-in. Rand drill put down four 18-ft. holes in medium hard dark granite in 10 hours, a total of 72 ft.

A 3½-in. Rand drilled two 25-ft. holes in black granite and bands of hard red granite in 10 hr. All of these include time of setting up the machine and blow-out the holes.

For a 3½-in drill working consecutively in one cut the following record was kept for 3 days:

1 hole 17 ft. 6 in. drilled in	7 hr.
1 hole 18 ft. 6 in. drilled in	8 hr.
1 hole 16 ft. 10 in. drilled in	4 hr.
1 hole 11 ft. 8 in. drilled in	5 hr.
1 hole 16 ft. 6 in. drilled in	5 hr.
1 hole 13 ft. 8 in. drilled in	3 hr.
Total, 94 ft. 8 in. drilled in	32 hr.

This is an average of 3 ft. per hour.

These records are all very low, due to the hardness and toughness of the rock, and also to the fact that all these holes are 15 ft. or more in depth, thus being classed as deep holes, while the drills are all comparatively small, and were not designed to carry such heavy steel. To put down holes 25 ft. deep with a 3½-in. drill retards the speed of the drill exceedingly. Then, too, with these deep holes it must be remembered that the diameter of the holes is large for a greater depth than for shallow holes.

The above cost of 48 ct. per ft. is for one drill run from a boiler. To add another machine run from the same boiler would reduce this cost about 10 ct. per ft.

On most open cut work it has been the custom to drill the blast hole on or near the center line of the cut, so as to get the charge of explosive at the center of the mass to be moved. A 12-ft. hole is given a 12-ft. burden, while a 25-ft. hole is given from 20 to 25-ft. burden. But Mr. McFarlane writes that with a 20-ft. roadbed he prefers two holes located 10 ft. on each side of the center line, the burden not to exceed 15 ft. Holes should not be over 25 ft. deep, nor set back more than 14 or 15 ft. If cuts are deeper than this they should be made into two lifts. Figs. 140 and 141 show arrangement of holes used by Mr. McFarlane. He finds that excessive burdens are the cause of most blasting troubles.

Springing the Holes. After drilling, the bottom of the holes are chambered to receive the charge by springing with dynamite. In a bottom bench where a heavy lift is required, no more than a foot is chambered. In upper benches it is permissible to chamber 2 or 3 ft. of the hole. If the tamping stick shows that the hole has been filled for 8 or 10 in. with dynamite at the bottom, it may be expected that the chamber will be 1 ft. deep, while a

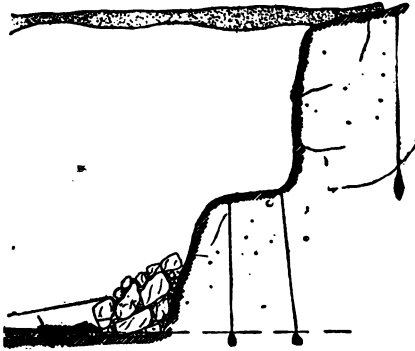

Fig. 140.
Longitudinal Section.

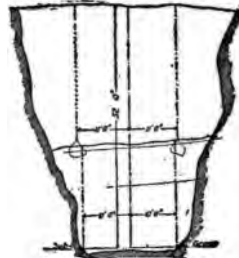

Fig. 141.
Front View.

12 or 15-in. rise of the tamping stick will show a chamber of 2 to 3 ft.

The springing opens up the rock jointing and indicates very closely where the burden of the shot will cleave from the solid, and the successive springing charges indicate the ratio of enlargement of the pocket.

The effective force of the main blast is a short, powerful blow equivalent in length to about one-half the diameter of the powder charge. This blow is transmitted in all directions. In the immediate vicinity of the powder charge the compression is so great as to crush and pulverize the rock. As it expands toward the free faces its energy becomes absorbed by the elasticity of the rock, and the recoil from the compression throws the rock out. The jointing in the material rock materially influences the results of the heavy blast. Large irregular jointing, such as is found in the granite where quartz and feldspar predominate, causes the most trouble.

The heavy springing opens up the jointing, and the blocks shift irregularly on the bed planes, often completely closing off the drill hole. Here is one great advantage of machine-drilled holes, for, owing to their greater diameter, they permit of considerable shifting before the hole is cut off. The effects of floors and slips between the explosives and the free faces is to cause the rock to cut off at one of these floors, while the rock around the explosives is merely crushed and shattered. These slips and floors deaden and deflect, or at least imperfectly transmit, the shock of the explosion. On the other hand, if the slips and floors are *behind* and under the blast charge, the shot would tear back to *these slips* and floors, giving a great deal more muck than would be expected.

The slips and floors put a practical limit to the size of the blast. It was found that this limit was reached on the 30-ft. holes, burdened 15 ft., and throwing out from 400 to 800 tons of muck.

In springing, the first two springs should indicate the ratio of enlargement of the pocket. That is, should the first spring of 2 sticks occupy 10 in. of the lower part of the hole, and should next spring of 6 sticks occupy 10 in. of the hole, the ratio of the charge is 3 to 1. If previous experience has shown that 150 sticks per 100 cu. yd. of rock throws a nice shot, and the hole being loaded is to throw 200 cu. yd., then the blast charge would be 300 sticks. In springing this hole 12 sticks should be used on the 3rd spring, 36 on the 4th, and 100 sticks on the fifth and last spring, using the ratio of 3 to 1 successively.

The following is the actual record of two holes sprung and shot. The holes were shot simultaneously, each being 26 ft. deep and set back 14 ft.

Hole No. 1. Springing:

6 p. m. Friday, sprung with 2 sticks (60%) water tamped.
 8 p. m. Friday, sprung with 5 sticks (60%) water tamped.
 7 a. m. Saturday, sprung with 12 sticks (60%) water tamped.
 11 a. m. Saturday, sprung with 30 sticks (60%) sand tamped.
 5 p. m. Saturday, sprung with 70 sticks (60%) sand tamped.
 Total, 119 sticks of 60% dynamite.

Hole No. 2. Springing:

6 p. m. Friday, sprung with 2 sticks (60%) water tamped.
 8 p. m. Friday, sprung with 5 sticks (60%) water tamped.
 7 a. m. Saturday, sprung with 12 sticks (60%) water tamped.
 11:30 a. m. Saturday, sprung with 35 sticks (60%) water tamped.

5:45 p. m., sprung with 100 sticks (60%) sand tamped.

Total, 154 sticks of 60% dynamite.

Blasting. The blast was put off at 11:30 a. m. Sunday, the charge in hole No. 1 being 275 sticks, of 40% dynamite, and that in No. 2 being 150 sticks of 60% and 175 sticks of 40% dynamite. Each stick of dynamite weighed 0.35 lb. These holes broke 450 cu. yd. of solid measurement of rock. The cost being:

Springing:

Blasting foreman, 11 hr. at 37½ ct.	\$ 4.13
Powder monkey, 5 hr. at 22½ ct.	1.12
Steam for blowing holes	1.50
Caps and fuse15
Electrical exploders78
88 lb. dynamite (60%) at 22 ct.	19.36

Total springing \$27.04

Blasting:

Blasting foreman, 5 hr. at 37½ ct.	\$ 1.88
Powder monkey, 5 hr. at 22½ ct.	1.32

155 lb. (40%) dynamite at 18ct.	\$27.90
50 lb. (60%) dynamite at 22ct.	11.00
Electrical exploders52
Total blasting	\$42.42
	Per cu. yd.
Drilling	\$.048
Springing060
Blasting093
Total	\$.201

The muck from this shot was in fine shape. Only 3 pieces required to be block holed.

The only rule for determining the amount of powder to use per cubic yard is to measure up a good shot and divide the charge by the number of yards thrown out. This standard quantity should be varied as the slips and floors in the rock are for or against any particular shot. Mr. McFarlane states that about 0.4 lb. of 40% dynamite per cu. yd. of rock is about right for the main blast, and about 0.38 lb. of 60% dynamite for springing each cubic yard of rock. The average powder consumption on the Canadian Pacific double track work from Fort William to Winnipeg for the past year was 1¼ lb. per cu. yd. Most of this was dynamite averaging 50%, but some black powder and "Virite" was used.

Mr. McFarlane finds that 3 kegs (75 lb.) of black powder are equal to 50 lb. of 40% dynamite. Neither dynamite nor black powder will throw a good shot if the rock has been shaken up too much by previous springing. With large burdens the heavy springing opens up the seams so much that excessive powder charges are required to make a shot; and the explosive is apt to kick back through a seam and leave a standing shot. The muck from a very heavy blast is usually coarse and requires much block holing and mud capping before it can be handled. It is very seldom that a heavy blast throws the rock far, the bulk of the muck being heaved 20 to 50 ft., and very rarely are any fragments thrown more than 150 ft.

The dumpman, with a tally board, kept account of the loads hauled out of the cut. He kept a separate record of the fine or shovel dirt and of the loads of large masses. After each round of blast holes was cleared up and the bottom of the cut squared up with pop shots, the excavation was measured, and the yardage in the solid thus determined, divided by the total number of loads hauled out, gave the number of yards to a load. In this way the amount of fine material was approximated. It was found that generally 20% of the muck was shovel dirt; about 30% stone which could be lifted and loaded by the muckers; the remaining 50% consisting of large blocks from 1 to 50 cu. yd. in volume. Most of these had to be broken up.

The methods and costs of breaking up boulders on this work are described on page 643 of this chapter. The methods of handling the muck by stone boats and cars are described in Chapter XII, page 518.

In excavating an approach to a tunnel of red granite, which weighs 4,400 lb. to the cu. yd., 7,024 cu. yd. was excavated from Nov. 16, 1906, to April 24, 1907. Stone boats and pole tracks were used for this work, the average haul being 500 ft. Muckers were paid \$2.00 to \$2.25 per day of 10 hr.; foremen, \$3.75; horses cost 75 ct. per day to feed. The following was the unit cost of excavating this 7,000 cu. yd. cut:

	Per cu. yd.
Drilling	\$.048
Labor, springing and blasting030
Dynamite024
Black powder024
Wire exploders008
Blasting boulders104
Labor loading308
Transporting165
Total	\$.711

To the cost given above of 71 ct. per cu. yd. Mr. McFarlane adds 25 ct. for general expense, the general expense charge for 7,000 cu. yd. being made up as follows:

Superintendence	\$ 750
Moving outfit	200
Half cost of building camp	718
Miscellaneous expenses	75
Total	\$1,743

For 7,024 cu. yd. this is a cost of 25 ct. per cu. yd.

Camp. The camp consisted of the following buildings, which gave accommodations for 30 to 35 men. Bunk houses 22 x 32 ft., cook house 20 x 32 ft., office and commissary 16 x 18 ft., stable 16 x 20 ft., boiler house 18 x 26 ft., powder thaw house 10 x 10 ft., and blacksmith house 16 x 18 ft. These buildings were built of logs hewed on the inside, plastered inside and mossed outside. The roof of each was made of 1-in. lumber covered with rubberoid paper. The cost for the camp was:

Lumber, nails, roofing, window sashes	\$ 440
Cutting and hauling logs	80
Labor building camp	861
	<u>\$1,361</u>
Piping up boiler and pumps	75
Total cost	\$1,436

In all, the buildings covered 2,808 sq. ft., making a cost of 51 ct. per sq. ft. The log huts make warm quarters for men in a cold country, but as a rule they are more expensive to build, when lumber can be bought for \$20 per M or less.

Rock Excavation on the Watauga and Yadkin Valley Railway. Mr. H. C. Landon, General Manager Watauga and Yadkin River Railroad Company gives the following description of the method and cost of rock excavation by company forces on 24 miles of single-track railway in North Carolina. These data were published in *Engineering and Contracting*, Apr. 1, 1914. The total yardage moved was 475,052 cu. yd. of which 99,688 cu. yd. were rock. The labor cost, including explosives, was approximately 36 ct. for rock excavation and 12 ct. per cu. yd. for earth. Including both earth and rock excavation 213,250 lb. of powder and 24,000 lb. of dynamite were used. It is estimated that the powder removed 80,000 cu. yd. from the grade so that no further handling was necessary. An additional large yardage of material was shaken up to be loaded by wheelers or loaded into carts or cars.

Much of the line was located in the side hills and in places where heavy blasts could be made without endangering life or property; this afforded a splendid opportunity for the use of explosives. However, the experienced men that were employed had only used explosives to shatter or break up rock or hard soil so that it could be handled by either hand or steam shovels, and much valuable time and good powder were wasted before the method of using powder was so improved that the blast would move the maximum amount of rock and earth out of or off the railroad grade.

As the old time powder men rather believed in the single shot or two or three shot method, it was difficult at first to get the desired results. Finally all blasts were planned in advance and for some time no heavy blasting was done except under the personal direction of the general manager. The cuts were usually of a length where 30 or less than 30 holes would cover the portion of the cuts to be removed, so that a No. 3 blasting machine would explode the blast.

The holes were placed on lines that have since been made standard for the railroad construction. In general where the cut at the center-line was over 4 ft., and where the material was earth or soft rock, the first line of holes was placed not more than 2 ft. above the center line on side hill cuts. All holes were driven to a point 2 ft. below grade and usually were about the same distance apart as the depth of hole to grade except when the depth was greater than 15 ft. The maximum distance apart was about 15 ft. If the hillside was steep and the lower side of the road bed was at grade, one set of holes was sufficient. If the cut was a "through cut" with a depth of 2 ft. or more on the lower side, then, ordinarily, a lower set of holes was drilled parallel to the first at the lower ditch line at points midway

between the upper holes so that there would be no doubt as to moving the material out of the way. The additional holes did not add materially to the amount of powder used, as 1 cu. yd. of soft rock should be moved with about 2 lb. of powder. The soft rock usually was a decomposed granite or Carolina gneiss which was not hard to drill.

The hard rock was usually a mica schist. It was very hard, and in it the upper line of holes was placed on the upper ditch line and a distance apart equal to the depth. No holes were placed farther apart than 10 ft. The lower holes were placed on the lower ditch line at the same distance apart but intermediate to the upper line of holes.

This arrangement had to be modified according as the rock was hard or soft in the same cut and also according to the strata encountered. The general tendency was to use too much powder in the soft rock and too little in the hard rock. The most efficient quantity of powder, was, in soft rock, 2 lb. or less per cu. yd., and, in hard rock, 3 lb. or more per cu. yd.

In all the smaller shots the holes were made on the center line to a point about 2 ft. below the grade line and were spaced a distance apart equal to the depth of the hole. It was found that the holes drilled on the center line, and to this depth below the grade, would ordinarily pull down the grade to about the amount desired, and would not move the earth too far back of the slope line when soft rock was handled.

Steam drills were used with hard rock but a large percentage of the other holes were put down by hand hammer and churn drills. In many places hand churn drills were successful in soft rock. In all hard rock steam drills were used when possible. The two steam drills used were the Ingersoll T-24 type with 3-in. cylinders and 6.5-in. stroke; one 12-hp. boiler supplied the two drills.

Cost of Excavating Rock Side Hill Cuts. Several large blasts were successfully made in side hill cuts on different sections of the line, moving almost 0.5 cu. yd. of material for each pound of powder used. In one cut, estimated at 8,000 cu. yd., 95% of which was solid rock, 23 holes were driven in two rows, the upper row being approximately 20 ft. deep, and extending 2 ft. below grade, while the lower holes were 16 ft. deep extending 6 ft. below grade. The holes were "sprung" twice, first by using 5 or 6 sticks of dynamite and then by using 25 or 30 sticks. A second "springing" of the holes was necessary, although it is believed that one "springing," using 10 or 12 sticks of dynamite, would have given better results, as the second springing tended to fill the holes rather than open them up to sufficient size. An average of 11 kegs of powder was used in springing the upper holes and

of 13 kegs for the lower holes. The result of this blast was very satisfactory: 417 kegs 25 lb. powder were used moving fully 1,000 cu. yd. of rock. A No. 3 push-down battery was used in this explosion although this was overloading the battery slightly.

Fig. 142A shows the profile of the cut where the blast was made and a plan showing the location, spacing and the arrangement of the 33 blast holes. Fig. 142B shows the typical cross section of the cut before and after the blast, and as completed. A wagon road was shifted farther back from the river after the grading was done.

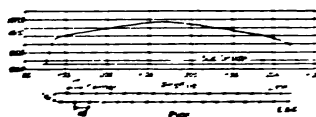

Fig. 142A.

Plan of Blast Holes.



Fig. 142B.

Side Hill Cut.

Another small side hill rock cut was blasted on June 16, 1913. The holes were drilled by hand. Six lower holes were drilled approximately 4 ft. down hill from the center line to depths of from 7 to 11 ft. Three holes were drilled along the center line and 17 holes having depths of from 11 to 18 ft. were drilled at an average distance of 7 ft. above the center line. All holes were drilled about 2 ft. below sub-grade. The rock was of hard grade character and 3 cans of powder were placed in most of the deepest holes although one hole required 11 cans. Three cans were loaded into the shallow holes. The cost of making the blast and cleaning out the cut, which contained a total of 1,300 cu. yd., follows. The item of \$126 was for labor in cleaning out the loose material left by the blast and in dressing up the cuts.

	Total cost.	Per cu. yd.
121 cans of powder at \$1.30	\$157.30	\$.121
150 lb. dynamite at 15ct.	22.50	.017
50 20-ft. fuses	3.40	.003
58 16-ft. fuses	2.78	.002
Labor, drilling and loading holes.....	135.00	.104
Labor, 84 men at \$1.50, cleaning	126.00	.096
Total	\$446.98	\$.343

About 320 ft. of holes were drilled at a cost of approximately 40 ct. per ft. for drilling labor. It required 0.24 ft. of hole per cu. yd. of rock blasted. Powder was used at a rate of 2.3 lb. per cu. yd. of rock blasted, the springing of the holes requiring 0.12 lb. of dynamite per cu. yd. of rock. It was estimated that 900 cu. yd. of rock was shot out of the cut, so that the

unit cost for clearing out the cut was $\$126 \div 400$ or $\$0.31$ per cu. yd. of rock left in the cut after the blast.

Cost of Excavating a Thorough Cut. A "thorough cut" containing 2,200 cu. yd. of rock was blasted. The material was medium hard rock, much of it being mica schist. Thirty-seven holes were drilled and fired in 11 blasts. About 28 "pop shots" and small shots were required for breaking up rock and removing rock to a point below grade. Some of the material was moved by wheelbarrows to the side of the cut but the greater portion was moved by carts into a nearby fill, the haul being about 250 ft. The cost of excavating the cut was as follows:

	Per cu. yd.
Mules and carts	\$.021
Labor463
Explosives079
Total	\$.563

Cost of Approaches to Tunnel near Peekskill, N. Y. In the approaches to a tunnel and in widening cuts south of the tunnel 45,698 cu. yd. of rock were removed. On account of proximity to railway traffic, blasting could be done only at limited periods, which made the cost of excavation high. Rock was loaded on flat cars with stiff leg derricks provided with bull wheels. The cost was as follows:

Equipment (less present value), supplies and repairs	\$11,673.60
Dynamite and exploders	6,588.82
Coal	2,490.13
Oil, waste, etc.	370.59
Lumber for buildings	634.22
Miscellaneous	373.19
Labor	69,550.66
Total	\$91,681.21
Average cost per cu. yd. paid for	\$2.24
Average cost per cu. yd. taken out	\$2.01

Cost of Excavating Sandstone and Shale. In excavating shales and sandstones of the coal measures of Pennsylvania, Ohio, Virginia, etc., I find that holes are usually 20 to 24 ft. deep, and spaced 12 to 18 ft. apart. On an average we may say that for every cubic yard of solid rock there is 0.1 ft. of drill hole, when cuts are very wide, covering large areas of ground; but in thorough cuts for railroads it is not safe to count upon much less than 0.2 ft. of drill hole per cu. yd. The holes are almost invariably sprung with 40% dynamite and then charged with black powder. As low as 0.02 lb. of dynamite per cu. yd. may be used for springing holes in shale, and as high as 0.5 lb. per cu. yd. in sandstone that is to be very heavily loaded. (See page 497.) I should put the average at 0.05 lb. of dynamite per cu. yd. of shale, and 0.1 lb. per cu. yd. of sandstone. A very common charge is 8 kegs (200 lb.) of black powder per hole, or

about 1 lb. per cu. yd. in side cuts, and 1½ to 2 lb. per cu. yd. in thorough cuts, although as high as 3 lb. per cu. yd. have been used in thorough cuts in sandstone where special effort was made to break up the rock to small sizes for steam shovel work. The drilling of the deep holes costs not far from 53 ct. per ft. where drilling is done by hand with wages at 20 ct. an hour, and it may be as low as 25 ct. a ft. if cable drills are used. Soda powder costs about 5 ct. per lb., and 40% dynamite 12 ct. per lb. We have, therefore, the following:

	Ct. per cu. yd.
Drilling .1 ft. to .2 ft. at 50ct.	5.0 to 10.0
Dynamite, .05 lb. to .1 lb.6 to 1.2
Powder, 1 lb. to 2 lb.	5.0 to 10.0

Total for loosening the rock 10.6 to 21.2

The rock is commonly loaded with steam shovels, and it is not safe to count upon more than 500 cu. yd. of shale or 250 cu. yd. of sandstone per shovel per 10-hr. shift. The daily (10-hr.) cost of operating a 55 ton shovel will average about as follows:

1 foreman	\$ 5.00
1 engineman	4.00
1 craneaman	3.50
1 fireman	2.25
6 pit men at \$1.75	10.50
1 dinkey locomotive driver	3.50
1 trainman	2.25
4 dump and trackmen at \$1.75	7.00
1 pumpman	2.50
1.8 tons coal at \$4	7.20
Oil and waste75
Repairs	12.00
Interest and depreciation, 16% of \$12,000 ÷ 150 days worked per year	12.80
Total daily cost	\$73.25

In round numbers this is \$75 a day where only one train is used. With a daily output of 250 cu. yd. in sandstone, the loading and transporting costs about 30 ct. per cu. yd. exclusive of general office expense and the cost of installing and removing the plant. This applies only to short hauls, such as 1,000 ft., and where construction trestles are not needed. Where grades are steep and distances long, two or more dinkey locomotives with cars will be required.

Loading and transporting shale short distances (1,000 ft. or so) costs about half as much as sandstone.

Other data bearing on steam shovel work will be found in Chapters XII and XVI. It is necessary to study all the conditions of each case and to apply the data given in various parts of this book. I have merely given the above as an example of shale and sandstone excavation on railway work.

Methods and Cost of Railway Excavation in W. Va. (Engi-

neering and Contracting, Aug. 5, 1908.) In keeping cost records for excavation it is an easy matter to arrive at the cost of moving solid rock and earth if all the material to be moved in a cut is either one or the other, but, as frequently happens, a single cut will have solid ledges of rock, large and small boulders, and earth on top of all of this rock.

The unit costs of earth and rock derived from the cost records under those conditions are not actual costs, but depend upon the classification allowed by the engineers.

This statement does not apply to earth and rock cuts that are first stripped of earth, but to such cuts as are blasted from the top and the earth and rock handled at one time, as is nearly always done in mountain railroad building. In considering cost data of excavation, other than earth, these facts must be kept in mind:

This work was a heavy cut about 25 ft. deep on the line of a new railroad that was built a few years ago in West Virginia. The cut was a "thorough cut," being a little higher on one side than on the other. The earth was a stiff, red clay, mixed with disintegrated sandstone, and the rock was a red sandstone that dulled a drill and made a large amount of sludge, but not as much as a shale rock makes.

The specifications were very fair, classifying the sandstone as solid rock, disintegrated sandstone as loose rock, and the clay as earth. The classification put on the cut by the engineers was earth 31%, loose rock 25% and solid rock 44%.

A 10-hr. day was worked with Austrian laborers who received \$1.50 per day. Negro drivers were used and were paid \$1.25. The contractor owned his own mules, and two mules and two carts were used in the cut, one driver attending to the two. While one cart was being loaded the driver took the other to the dump and returned. It cost about 60 ct. per day to feed and care for a mule and \$1 a day was charged for a mule, a cart and the necessary harness. This was ample to cover the expense of the horse and depreciation and interest on the outfit. This made a total charge for teams (two mules and driver) of \$3.25 per day. The wages paid the foreman varied, being an average of \$2.40 per day. When the work was commenced capable foremen were scarce, and a fair foreman was employed for \$2 per day. He made profits on the work, but he was replaced by a better man at \$3 per day, and this man was finally replaced with a foreman whose rate was \$3.50 per day. The record of cost each day showed an improvement under each of these new foremen illustrating that a high-priced foreman is the man to employ. If a good foreman could have been obtained at the start, the costs to be given would have been reduced somewhat.

Dynamite (40%) cost 10 ct. per lb., black powder cost \$1.10 per keg of 25 lb. Double tape fuse cost 42 ct. per 100 ft., caps cost 60 ct. per 100 and electrical exploders cost from 4 to 7 ct. each.

The gang working in the cut consisted of 10 men, including the driver, but exclusive of the foreman. Eight men worked in the cut, three men always shoveling, the rest doing the picking, drilling and boulder breaking. One man attended to the dump. This man, by means of a tally board, kept a record of the cartloads of material delivered to the dump. The number of loads delivered in a month, divided into the yardage given in the engineers' estimate, showed that the average load carried by a cart was $\frac{1}{2}$ cu. yd. It must be remembered that these loads consisted of solid rock, loose rock and earth, hence the average load would be much larger than when rock alone is being handled. The carts were used without tail gates. For records showing the capacity of dump carts when hauling rock, see page 608.

Keeping a tally of loads is an excellent incentive to spur men to rivalry on excavation work. Such records should be posted each day where the men can see them, and make comments upon the work done by the various crews. Such records also give a ready check on the yardage moved and show whether or not the work is being handled to advantage.

The drilling for blasting was done by hand with long churn drills. These are made by welding a piece of tool steel about 18 ins. long to a long piece of bar iron or to a section of $1\frac{1}{2}$ -in. pipe. In this case the top of the cut being earth and loose rock, the drilling with a churn drill was done quickly until the solid rock was reached, when a 15 to 25-ft. drill was used, giving enough weight to carry the bit through the harder rock at a good rate. In blasting, two holes were drilled abreast in the cut, each being just inside of the toe of the slope. These holes were sunk by three men 1 ft. below the profile grade, and were sprung with dynamite. The holes were shot with black powder, the charge not being heavy enough to throw material outside the cut. The contractor exercised great care in this, as the specifications provided that all material wasted in this manner by the contractor should not be paid for by the railroad company and this provision was rigidly enforced. The two holes were shot simultaneously with electrical fuses and a battery.

Boulders and large rocks were drilled for the most part with hand drills and shot with dynamite and fuse. Some of the boulders were "undermined," while some were "mud capped," but both of these methods are more expensive than "block holing."

The amount of explosives used in blasting the cut and breaking up the boulders averaged $\frac{1}{2}$ lb. to each cubic yard of ma-

terial. This was made up of 0.4 lb. of black powder and 0.1 lb. of dynamite. The solid rock was the only material that had to be broken up after it was blasted, to be handled, and this took on an average of 0.3 lb. for each cubic yard of solid rock. The writer believed this could have been reduced by using Judson powder for blasting the cut, instead of black powder. The Judson powder would have pulverized and broken up the ledge of sandstone much better than the black powder did.

Some of the boulders were broken up by sledge hammers. To assist in this work several "gads" were used. A gad is a wedge-shaped piece of steel that is driven into a rift or seam of a rock to split it. A gad can save much time in sledging stone. A little water thrown on the stone will assist in the gad taking hold better when it is being hit.

Another device that saved money in handling the boulders was a "devil," see Fig. 143. It consisted of several boards 1 x 8 in., nailed to two 3 x 4 in. scantlings or round poles. This is placed on the ground and a boulder a cubic yard or less is rolled on to the devil. Then the crew of men take hold of the handles and lift it high enough to dump the boulder into the cart. This is done to better advantage when the crew is just beginning to load the cart.

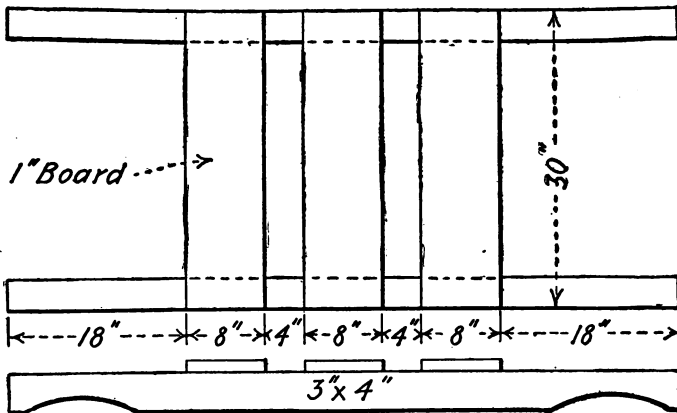

Fig. 143. "Devil" for Handling Boulders.

The work was done in the winter and early spring. The cost per cubic yard was as follows:

Earth.	Per cu. yd.
Foreman	\$.016
Laborers071
Dumping009
Carts and driver020
Explosives014
Total	\$.130
Loose rock.	Per cu. yd.
Foreman	\$.031
Laborers142
Dumping017
Carts and driver038
Explosives028
Total	\$.256
Solid rock.	Per cu. yd.
Foreman	\$.053
Laborers243
Dumping030
Carts and driver066
Explosives048
Total	\$.440

It will be noticed that these costs do not include superintendence, blacksmithing and general expenses. These costs will ordinarily average not over 2 ct. per cubic yard when 100 men or more are being worked on a contract. The cost of liability insurance on this work was not quite $\frac{1}{2}$ ct. per cubic yard.

To illustrate the method used in deriving the above given costs, let us take an example. Suppose the bidding prices are 15 ct. per cubic yard for earth, 30 ct. for loose rock and 57 ct. for solid rock. Suppose the engineer's monthly estimate gives the contractor \$2,500, while the contractor's records show an actual cost of \$2,000. The total actual cost was, therefore, 80% of the amount received. Hence 80% of 15 ct. gives 12 ct. as the actual cost of the earth per cubic yard. Likewise, 80% of 30 ct. gives 24 ct. as the actual cost of the loose rock. As above stated, it is clear that this method does not give true actual costs unless the engineer's classification is perfect and unless the contractor's bidding prices are perfectly balanced.

Cost of Earth and Rock Excavation in Steam Shovel Work. (*Engineering and Contracting*, Aug. 5, 1908.) The separate cost records for earth and rock work described herewith were derived from composite records of the cost of the two classes of excavation by a method similar to that described in the preceding paragraph. The sand was a red clay mixed with mica and might be classed as "average earth." The rock was granite and was in the bottom of the cut over an area about 200 ft. long. The excavation and removal of this rock materially delayed the progress of the work. The number of cars loaded each day when working in the rock was about $\frac{1}{3}$ as many as when working

in earth. The sides of the cut were excavated at a slope of $\frac{1}{4}$ to 1, the steepness of which resulted in several cave-ins. In two months 29,800 cu. yd. of clay and 1,200 cu. yd. of solid granite were excavated.

The outfit included a Bucyrus 65-ton shovel, equipped with a $2\frac{1}{2}$ -cu. yd. dipper; 2 Rogers locomotives with 16-in. cylinders; 24 Kilbourne and Jacobs 6-yd. two way dump cars; 1 gasoline pump; a 10,000-gal. wooden tank; and a $3\frac{5}{8}$ -in. Ingersoll drill, operated by steam from the boiler of the shovel. The cost of the outfit was as follows:

Steam shovel	\$10,000
2 locomotives (second hand)	10,000
24 6-yd. cars	3,000
Tanks, pumps, etc., for water	1,000
Rock drill, etc.	400
Blacksmith shop	200
Hydraulic jacks, etc.	400
Small tools	1,000
Camp	1,000
Total	\$27,000

Methods of Working. In order to operate the contractor's trains the railroad company furnished a telegraph operator, but the contractor boarded him free of charge. The dirt train operated on "work train orders." The railroad company kept an inspector on the work, and with the company's permission the contractor paid him a salary as superintendent of dumps.

The temporary trestle was about 25 ft. high. It was built of round poles, costing 3 ct. per ft. delivered on the ground. The braces used were 3 x 8 in., and the stringers were 12 x 12, 18 ft. long, the bays of the trestle being 16 ft. long. This timber (pine) cost \$10 per M ft., B. M. The trestle was erected by a sub-contractor for \$3 per M. This gave a cost for the temporary trestle complete of $1\frac{3}{4}$ ct. for each cu. yd. dumped from the trestle. Only one-half the material excavated in these two months went to this trestle.

The men making up the train crews had to pass the examination given by the railroad company to men occupying similar positions, and in their work were subject to the rules and regulations of the railroad company.

The blasting of the rock had to be done with great care, so as not to interfere with the traffic on the railroad. Large boulders were loaded with the shovel by means of chains. One boulder measuring 4 cu. yd. was raised off the ground by the shovel, but as there was danger of breaking the car with it, it was not loaded. All the drilling for the blasting, both deep holes and block holes, was done by the steam drill. To protect the front of the shovel a canvas curtain was hung up, when blasting was going on, and 2 in. boards were put on top of the shovel to pro-

<i>Rock, continued.</i>	Per cu. yd.
Dumping	\$.190
Miscellaneous046
Interest and depreciation089
Total	\$.656

It will be noticed that the wages paid laborers on this job were low, but other employes were paid standard wages or higher.

One Month's Output of a Steam Shovel. Mr. B. M. Langhead in *Engineering News*, May 18, 1911, gives the following costs of work done by a 70-ton steam shovel on the first division of the Cumberland-Connellsville Division of the Western Maryland Ry., during the month of March, 1911. The shovel was working in a 134,000-cu. yd. cut, the total output during 30 working days of 10 hr. each was 37,100 cu. yd. The material consisted of 16,000 cu. yd. of hard sandstone, the removal of which occupied 15 days, and 21,100 cu. yd. of black shale.

In order to make the fill, a switchback was necessary. The grade from the mouth of the cut to the point of the switchback was 3.5% over a distance of 950 ft. The length of haul from center of gravity of cut to center of gravity of fill was 1,600 ft. Midway of the switchback was a passing siding of a size sufficient to hold a dinkey locomotive and twelve cars. A 16-ton dinkey hauled twelve 4-yd. cars. To start the fill a trestle was built and the down hill rail was given superelevation to prevent cars from overturning when dumping. When large boulders were handled the cars were chained to the rail.

The total number of car loads was 12,443, the average load per car being 2.98 cu. yd., and the average number of cars per day was 415. The maximum day's work was 836 car loads. The shovel was shifted 5 times during the month, a distance of 500 ft. each time. The average loss per day due to shifting track on the dump was 1 hr. The track gang was composed of 1 foreman and 4 laborers and the dump gang of 1 foreman and 8 laborers.

The equipment consisted of a 70-ton Bucyrus shovel, two 16-ton Vulcan dinkey locomotives, 24 Western dump cars (4 yd.), 54 tons of 60-lb. rails, and a Cyclone cable well drill.

The cost of the work for one month was as follows:

	Total	Per cu. yd.
Labor	\$3,623	\$.098
Explosives	302	.008
Trestle	229	.005
Coal	235	.007
Oil and waste	32	.001
Water	112	.003
Interest on plant	110	.003
Depreciation	460	.012
Total	\$5,103	\$.137

Total labor includes pay of superintendence, walking boss-shovel and dinkey crews, and all other labor.

Method of Blasting a Railroad Cut 1,800 Ft. Long with One Shot. In constructing the Portland, Eugene & Eastern Ry. line in Oregon a rock cut 1,800 ft. long and from 25 to 40 ft. deep was blasted in one shot by the Flagg & Standifer Co., contractors, of Portland, Ore. The roadbed is 20 ft. wide, with side slopes of 1 on 1 and the volume of the cut was estimated at 35,000 cu. yd. Six Star well drilling machines with 4-in. bits were used. They drilled 578 holes at a cost of 27 ct. per foot. The holes were arranged in five parallel lines, a center line, two lines 10 ft. on each side, and two lines 24 ft. on each side of the center line. The holes were placed 14 ft. apart on these lines and staggered. In several soft places a 5-in. well casing was used for drilling. The formation was a fairly soft rock, with a strata 8 to 12 ft. thick of very hard rock running through a part of the cut on a vertical angle of 15°. The holes were chambered with 60% nitroglycerin powder, and some of the holes were loaded from 6 to 8 ft. above the springing line in order to secure a thorough shattering effect. The holes were loaded with 27,275 lb. of 35 per cent gelatin dynamite and 1,200 lb. of 60% nitroglycerin powder. A 3-in. tin water pipe—not corrugated—was used to advantage in loading. It eliminated the adhering of powder to the sides of the holes. The loading required eight days.

Current for the shot was furnished by a dynamo 6,200 ft. from the site of the blast, and 18,000 ft. of No. 8 wire was used for conducting the current. The multiple system with No. 15 R. C. wire connections from the dynamo lead wires was used as shown by the sketch.

The shot was entirely successful and the material was broken up so as to be readily handled without "bulldozing."

I am indebted to Mr. C. W. Craig of the Flagg & Standifer Co. for the information from which this article has been prepared.

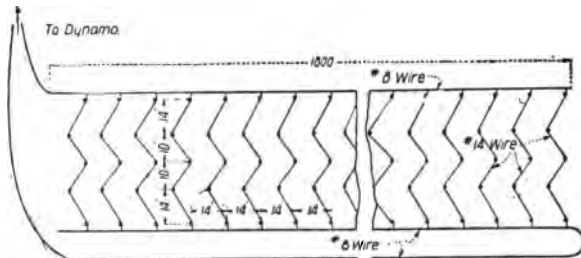

Fig. 144. Sketch Showing Layout of Holes and Wiring for Blasting a Railroad Cut.

A 16,000-Yd. Blast in Railroad Work. Mr. C. S. Young gives (*Engineering and Contracting*, Apr. 6, 1910) the following data on a blast in March, 1910, on the Pecos & Northern Texas Ry. A large cut in solid rock, with a maximum depth of 34 ft., and containing 70,000 cu. yd. was blasted as follows:

It was at the summit of this cut that the big shot was made. Eight holes were drilled on the center line, each being 22 ft. apart and ranging from 32 ft. to 37 ft. in depth. The first hole was about 18 ft. back from the crown of the preceding shot, the material of which had not been removed and still remained sloping down from the crown. This made quite a heavy pull for the first hole.

The holes were drilled by a cable well machine, drilling a 4½-in. hole, at a cost of 50 ct. per ft. Holes were sprung three times, using 60% dynamite; at the first 15 sticks were used, at the second from 50 to 60 sticks, and at the third from 250 to 300 sticks were used, springing the 8 holes together. The tamping after each spring was drilled out by the cable drill at a cost of \$12 per day and requiring about 12 days altogether. The drilling out of the tamping after the last spring was almost as difficult as the original hole owing to slight raveling of some of the holes and to the slight shifting of some of the ledges of rock.

In loading the holes FF and FFF black powder was used and they were loaded as follows:

	Kegs.
Hole No. 1	275
Hole No. 2	255
Hole No. 3	240
Hole No. 4	250
Hole No. 5	250
Hole No. 6	247
Hole No. 7	195
Hole No. 8	300

This makes a total of 2,012 kegs of 25 lb. each, or 50,300 lb. The total cost of the drilling, springing, dynamite, exploders, and powder was \$3,725.

The total yardage of the cut that was broken by the shot was 16,113 cu. yd., and the measurement of the cut afterward showed a wasting of 12,007 cu. yd., or 74.5%. As the holes were from 1.5 ft. to 2 ft. below grade it is reasonable to suppose that the 4,106 cu. yd. that were left at the bottom and on the slopes was loose material and if calculated with a 15% swell for breaking there is the equivalent to 3,571 cu. yd. of solid material left from the shot. Calculated in this way there was a waste of 77.8% of the cut at this part.

Diagram Showing the Increase in Cost of Rock Work with Shallow Depths. Mr. L. N. Jensen gives (*Engineering and Con-*

tracting, Oct. 30, 1907) a diagram (Fig. 145) showing the cost of rock excavation per cubic yard in railroad open cuts. The information refers only to the particular country and conditions in and under which the observations were made. The diagram shows the average cost of rock excavation in a number of cuttings on two railroads running from Parry Sound to Sudbury along the Georgian Bay. The rock was granite, and of an

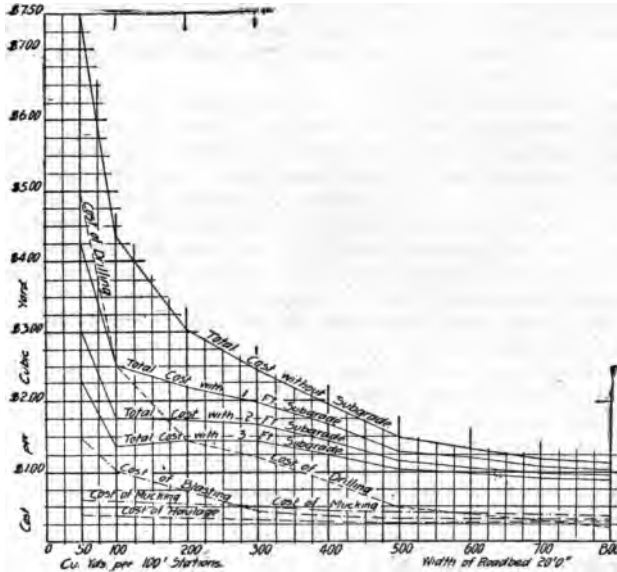

Fig. 145. Diagram Showing Relation of Unit Costs of Rock Excavation to Depth of Cut.

extra hard and tough character. All drilling was done by hand and all haulage was with teams and dragboats. Wages were \$2 to \$2.25 per day for labor and \$3.50 per day for blacksmiths and foremen. Team and teamster were paid \$5 per day. Neither foremen nor laborers were of the most efficient kind.

One railway allowed 1 ft. below grade in estimating pay yardage; the other allowed nothing. Both had separate classification for rock taken outside the theoretical slopes. In computing the quantities of the cuts all have been reduced to solid rock. The haul has been reduced to an average of 300 ft. The diagram shows the cost of the different items for cuttings running from 50 to 800 cu. yd. to the "station" of 100 ft. The width of the

roadbed is 20 ft. Ditches have been calculated extra and added to the quantities of the cuts.

The diagram shows the reduction in cost per cubic yard by allowance of from 1 to 3 ft. below grade in estimating pay quantities, and indicates that a fair specification in this particular country should have allowed 3 ft. below grade in cuttings running up to 400 cu. yd. for station; 2 ft. in cuttings running from 400 to 500 cu. yd. for station; and 1 ft. in heavier cuttings.

The drilling was, as the diagram shows, extremely expensive. The average work of a drill gang, 2 strikers and 1 drill holder, was only 14 ft. per day.

In order to ascertain the approximate depth of each cut in feet, divide the number of cubic yards per station by 80.

Summary as to Costs of Open Cut Excavation. The two cost items that the inexperienced man should seek first to inform himself upon, are: (1) The number of feet of hole drilled per cubic yard in different kinds of rock; and (2) the number of pounds of explosive required per cu. yd. under varying conditions. In Tables LVII, LVIII, and LIX (pages 497 to 500), I have given a summary of these items as applying to open cut work discussed in this book; the tables do not apply to trenching, tunneling or other narrow work.

By applying the preceding data as to unit costs of drilling, blasting, loading and hauling, it will be seen that rock excavation in open cuts ordinarily ranges from about \$0.50 to \$1.50 per cu. yd., the lower price being for shales and sandstones and the higher price for certain granites and traps where holes are closely spaced. It is a very common assumption that rock can be profitably excavated in open cuts at a contract price of \$1 per cu. yd., but it will be seen that each case requires special study.

Boulder Blasting. There are three ways of breaking up a boulder with explosives: (1) Block-holing; (2) mud-capping; and (3) undermining.

Block-holing consists in drilling a shallow hole in the boulder and exploding a small charge of high power explosive in the hole.

Mud-capping, or "bulldozing," or "adobe (or dobe) shooting" consists simply in firing some dynamite on top of the boulder, after covering it with a shovelful of earth, preferably wet clay.

Undermining or "*snake holing*" consists in boring a hole in the earth and firing a charge of dynamite in the hole directly beneath the boulder.

Block-holing is obviously the most effective way of using the explosive. It is surprising how small a charge of 75% dynamite in a block hole will break a huge granite boulder. The cost of drilling is greatly reduced wherever pneumatic hammer drills

(see page 640) are used. In the Homestake Mine these drills have largely displaced hand drills for the purpose of block-holing chunks of rock too large to sledge economically.

Mud-capping is very wasteful of powder, and should only be used where a few scattering boulders are to be broken. The "mud" tamping is obviously not sufficient to enable the explosive to do its best work.

Mr. George C. MacFarlane says: "The most effective way to break a rock by mud capping, is to pick out a little depression and form a wall around it with clay, fill this crater with dynamite, lay the cap on the center, and cover the whole with clay. If the cap is shoved into the dynamite, the breaking force is lessened."

On the St. Mary's Falls Canal work large fragments of rock, 5 x 5 x 4 ft. in size, required $\frac{1}{4}$ lb. of 40% dynamite in a 28-in. hole, or 5 lb. of dynamite in mud-capping.

A Du Pont catalog contains Table LXX giving charges of 40 to 60% dynamite for boulder blasting.

TABLE LXX. DYNAMITE CHARGES FOR BOULDER BLASTING

Weight of boulder, lb.	Size, cu. yd.	Approx. number of 1 $\frac{1}{4}$ by 8-in. cartridges.		
		Mudcapping.	Snakeholing.	Blockholing.
100	.02	.5	.5	.25
500	.12	1.5	1	.25
1,000	.23	2	1.5	.5
2,000	.47	3	2.5	.67
3,000	.70	3.5	3	1
4,000	.93	4	3.5	1.25
5,000	1.16	4.5	4	1.75
7,500	1.74	6	5	2.5
10,000	2.33	8	6	3.5

Undermining is more effective than mud-capping, because the boulder then acts as its own tamping; but very often the earth beneath the boulder is such that boring in it is too expensive, or it may happen that the boulder rests upon rocks. For data on the cost of blasting boulders, see pages 41, 42 and 43.

The quantity and grade of dynamite required naturally depends upon the size and shape of the boulder and the character of the rock. If boulders are largely buried in the ground it is best to lift the boulder from the earth by snakeholing, and then to break it by mudcapping or blockholing.

Figs. 146, 147 and 148, illustrate the proper methods of mud-capping, snakeholing and blockholing.

The tests described below, carried on by the Bureau of Mines, were made to determine the comparative energy expended by explosives under water and in the air, and by various methods of shooting. The test showed very conclusively that the block-hole method of breaking boulders and large fragments of rock is very much superior to and more economical than the mud-cap or "adobe shot" method of breaking, which is so commonly practiced.

"Adobe shots" were made on two high-grade limestone blocks cut from the same large block. The heavier block was selected for tests in the air. It was laid on two 6 x 6-in. timbers, and on the center of the top side a 50-gram 1¼-in. cartridge of the 40% strength low-freezing dynamite was placed. A No. 6 electric detonator was inserted in the cartridge and laid parallel to the vertical bedding planes of the block. The charge was then covered with a 35-lb. mud cap consisting of 30 lb. of dry fire clay mixed with 5 lb. of water, and fired. The block was not shattered on top, but pieces were split off around the sides. The other block was then immersed in a barrel of water having a temperature of 70° F. The water was 32 in. deep, there being 13¼ in. of water above the block. The charge was the same as in the previous trial except that no mud-cap was used, and the charge was coated with paraffin in order to protect it from absorbing water. On firing no apparent damage was done to the block and no cracks were visible. This trial was then repeated on the same block immersed in water with a charge of 100 grams. This greater charge did not break up the block as much as did the 50-gram charge when the block was in air only.

Other similar tests confirmed these tests in every particular, and again the confining effect of the surrounding material was shown. The above is presented as a confirmation of practical experience that submarine blasting requires larger charges to disrupt a given amount of material than open work on similar materials.

Block-hole tests were made on two similar high-grade limestone blocks cut from the same large block and weighing 198 and 205 lb. A hole 1 in. in diameter and 6 in. deep was drilled from the center of one side to the center of the block. Each was charged with 5 grams of the 40% strength low-freezing dynamite. A No. 6 electric detonator was used. The bore hole was filled with water in each case. The 198-lb. block was fired in air and the 205-lb. block was suspended in a barrel of water in the same manner as in the previous tests. Both blocks were broken. The following tabulation shows comparative results:

TABLE LXXI. COMPARATIVE RESULTS OF ADOBE SHOTS ON LIMESTONE BLOCKS

Condition of block.	Quantity of explosive used.	Weight of block.		Number of pieces over 3" in diameter.	Average weight of these pieces.	Total weight of small pieces.
		Grams.	lb.			
In air	50		215	82	13	15.5
In water *	100		203	104	8	24.6

* After firing a 50-gram charge.

COMPARATIVE RESULTS OF BLOCKHOLE TESTS WITH LIMESTONE BLOCKS.

	Grams.	lb.	lb.		lb.	lb.
In air	5	198	52	15	12.7	7
In water	5	205	59	11	18.2	5

It will be noticed from these figures that the quantity of explosive used when a block-hole had been drilled into the rock fragment was from one-tenth to one-twentieth as large as that required by the mud-cap or adobe-shot method.

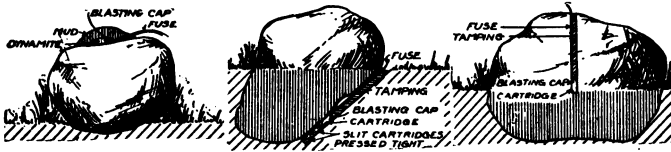

Fig. 146.
Mudcapping.

Fig. 147.
Snakeholing.

Fig. 148.
Blockholing.

Block Hole Drilling. Comparative methods and costs as stated by Mr. Charles C. Phelps in *Engineering and Contracting*, April 7, 1915.

Four ways of accomplishing block-hole drilling are open to the contractor or quarryman, namely: (1) With sledges and hand steels; (2) With mounted tripod drills; (3) With non-rotating plug drills operating with compressed air, and (4) With steam or air operated hand drills of the self-rotating type.

In order to compare the relative advantages of the four methods, an average case will be considered where the rock is a very hard limestone and where it is necessary to drill pop-holes averaging 12 in. in depth. The holes put in by tripod drills would probably be a little over 2 in. in diameter and those made by the first, third and fourth methods would probably be under 2 in. in diameter, but this difference can be left out of consideration because the smaller holes would be amply large for their purpose. The cost of sharpening steels can also be left out of consideration, for this would be nearly the same per foot of hole in all four cases. The wages for drill operators range from \$1.50 to \$4 per shift in various parts of the country and from \$1.50 to \$3 per shift for helpers. We will therefore use in our calculations the average wage of \$2.75 for drill runners and \$2.25 for helpers per eight-hour shift.

A medium size piston drill will require about 125 cu. ft. of free air per minute at 90 lb. pressure, or if operating on steam will require about eight boiler horsepower at a corresponding pressure. Both of the small types of hand drills will require less than half of this amount of power. In the most advanced type

of oil-engine driven air compressor, air can be compressed to this pressure for a fuel cost of about 4 ct. per 1,000 cu. ft., with kerosene at 8 ct. per gallon. The cost of steam at this pressure would be about $\frac{9}{10}$ ct. per boiler horsepower per hour with coal at about \$3 per ton, assuming 6 lb. of coal required per hour per boiler horsepower.

The following tables show the comparative costs per 12 in. hole:

DRILLING WITH SLEDGE AND STEEL.

Labor cost per shift, 1 drill man	\$2.75
Labor cost per shift, 2 sledge men	4.50
Total	\$7.25
Time required to cut 12-in. hole, about, minutes	15.0
Cost per 12-in. hole	\$0.227

DRILLING WITH MOUNTED PISTON DRILLS.

Labor cost per shift, 1 driller	\$2.75
Labor cost per shift, 1 helper	2.25

Total	\$5.00
Cost for steam (assuming drill in actual operation during $\frac{2}{3}$ of shift)23

Cost for labor and steam per shift	\$5.23
Cost for air (assuming drill in actual operation during $\frac{2}{3}$ of shift)	\$.96
Time required to cut 12-in. hole, about, minutes	5.0
Time required to move drill from previous setting and to adjust (5 to 10 minutes), average, minutes	7.5

Total per hole, minutes	12.5
Labor and steam cost per 12-in. hole	\$.136

DRILLING WITH ORDINARY PLUG DRILLS.

Labor cost per shift, 1 driller	\$2.75
Cost for air (assuming drill in actual operation during $\frac{2}{3}$ of shift and air consumption $\frac{1}{2}$ of mounted drills)	1.00

Cost for labor and air per shift	\$3.75
Time required to cut 12-in. hole, about, minutes	5.0
Time required to shift and for small delays, minutes	1.0

Total per hole minutes	6.0
Labor and air cost per 12-in. hole.	\$.047

DRILLING WITH AUTOMATICALLY ROTATED HAND HAMMER DRILLS.

Labor cost per shift, 1 driller	\$2.75
Cost for steam (assuming drill in actual operation $\frac{19}{11}$ of shift and steam consumption $\frac{1}{2}$ of mounted drills)26

Cost for labor and steam per shift	\$3.01
Time required to cut 12-in. hole, about, minutes	5.0
Time required to shift position, minutes5

Total per hole, minutes	5.5
Labor and steam cost per 12-in. hole	\$.035

Comparing the above estimates of cost, it appears that drilling with sledge and steel is extravagantly expensive. Drilling with mounted drills is also very expensive for this class of work, due mainly to the fact that more time is consumed in

setting up the drill than in actual cutting. The choice of equipment would, therefore, seem to lie between the two types of hand drills. The difference in cost of operation between the two latter types does not appear to be so great from the above estimate, but there are other considerations of equal importance which point to the automatically rotated hammer drill as the ideal type for steam shovel work.

Cost of Blasting Boulders. I am indebted to Mr. Hauer for the following data on the cost of blasting "loose rock" in railway cuts.

The boulders were red sandstone and blue sandstone, the latter being the harder and tougher of the two, and were all broken to sizes that could be loaded by hand. With wages of hand drillers and sledgers at \$1.50 for 10 hr., and 40% dynamite at 10 to 13 ct. per lb., the costs were as follows:

Sledging a 12½-cu. ft. blue sandstone boulder to small sizes took 1 man 5 min. and 2 men 2 min., at a cost of 4.9 ct. per cu. yd. Sledging a 16 cu. ft. blue sandstone boulder took 1 man 3 min., or 1½ ct. per cu. yd. Sledging a 12 cu. ft. blue sandstone boulder took 2 men 8 min., or 9 ct. per cu. yd. Sledging a 7½ cu. ft. blue sandstone boulder took 1 man 3 min., or 2.7 ct. per cu. yd. Sledging a 27 cu. ft. red sandstone boulder took 2 men 10 min., or 7½ ct. per cu. yd. Sledging a 23 cu. ft. red sandstone boulder took 3 men 5 min., or 4.1 ct. per cu. yd. Sledging an 18 cu. ft. red sandstone boulder took 1

TABLE LXXII

Reference.	Size of boulder, cu. yd.	Labor, ct.	Dynamite, ct.	Cap and fuse, ct.	Cost per cu. yd., ct.
1	17.0	30	\$2.10	9	14.7
2	1.6	8	20	2	18
3	1.0	8	15	2	25
4	.75	8	10	2	27
5	1.0	{ 8	15	{ 2	48
		{ 11	10	{ 2	
6	1.2	8	20	2	25
7	1.4	8	25	2	25
8	.7	{ 8	10	{ 2	68½
		{ 11	15	{ 2	
9	1.3	11	20	2	25½
10	.33	8	7½	2	52½
11	.45	11	15	2	62.2
12	.5	11	15	2	56
13	.5	11	10	2	46
14	.5	10	7½	2	38
15	1.7	10	17½	2	17.3
16	1.0	10	7½	2	38½
17	1.0	10	12½	2	24½

man 4 min., or $1\frac{1}{2}$ ct. per cu. yd. The average cost of breaking up small boulders with sledges was 5 ct. per cu. yd.

The cost of mud capping 17 boulders is given in Table LXXII in which the first four boulders were red sandstone, and the rest were blue sandstone:

Boulders No. 5 and 8 were blasted twice. In addition to the cost of mudcapping given in the table, the following was the cost per cu. yd. of sledging boulders: No. 5, 3 ct.; No. 6, 5 ct.; No. 7, 4 ct.; No. 10, 6 ct.; No. 15, 2 ct. The average cost of breaking up these 17 boulders by mudcapping was 36 ct. per cu. yd.

The cost of blockholing five boulders is given in Table LXXIII, all boulders except No. 1 being blue sandstone:

TABLE LXXIII

Reference number.	Size, cu. yd.	Depth drilled, ft.	Cost of drilling, ct.	Dynamite, ct.	Caps and fuse, ct.	Labor, ct.	Total, ct.	Total per cu. yd., ct.
1	13	3	105	20	2	18	145	11
2	3	1	40	10	2	3	60	20
3	$4\frac{1}{2}$	$1\frac{1}{2}$	52	12	2	10	76	17
4	$2\frac{1}{2}$	1	30	8	2	5	45	18
5	$2\frac{1}{2}$	$\frac{2}{3}$	20	10	2	4	36	18

The labor item in the seventh column includes the cost of lost time in leaving the pit during the blasting. Boulders No. 1 and 3 were fired alone, making this labor item greater than in the other cases when several boulders were fired at one time.

The cost of undermining and blasting sandstone boulders was as follows: A 50 cu. yd. boulder was broken up by undermining it, charging with black powder, and tamping with a large quantity of sand around it, the total cost being 25 ct. per cu. yd., distributed as follows:

4 kegs of powder, at \$1.64	\$ 6.56
$2\frac{1}{2}$ lb. 40 per cent. dynamite, at 16ct.40
Cap and fuse04
Labor	5.50
Total	\$12.50

The labor force was 1 foreman at 30 ct. an hour, 2 laborers at 10 ct. an hour and 1 boy at 5 ct. an hour. Five other smaller boulders were undermined and blasted at costs given in Table LXXIV.

Boulders No. 1 and 2 were red sandstone, and laborers were paid $13\frac{1}{2}$ ct. an hour; 40% dynamite, 11 ct. per lb. Boulders

TABLE LXXIV

Reference number.	Size, cu. yd.	Labor, ct.	Dynamite, ct.	Cap and fuse, ct.	Total per cu. yd., ct.
1	.9	10	5 1/4	2	19.4
2	1.5	13	16 1/2	2	21
3	1.25	9	8	2	15.2
4	1.0	9	8	2	16
5	2.5	9	8	2	8.4

No. 3, 4 and 5 were blue sandstone; laborers were paid 15 ct. an hour; dynamite, 10 ct. per lb.

Comparing the average costs of breaking up sandstone boulders by the four different methods we have:

By sledging	5 ct. per cu. yd.
By mudcapping36 ct. per cu. yd.
By blockholing17 ct. per cu. yd.
By undermining16 ct. per cu. yd.

In none of the cases did the men know that they were being timed, so that the costs may be assumed as fair averages. It is evident that mudcapping should be used only in steam shovel work through cuts where boulders must be broken up quickly so as not to delay the shovel. To illustrate how expensive it is to mudcap, one more example will serve. In a cut (approach to a tunnel) 1,054 cu. yd. of solid sandstone were excavated, 36 kegs of black powder costing \$51 being used. In this same cut there were 512 cu. yd. of loose rock (boulders) which were broken by mudcapping, requiring 750 lb. of 40% dynamite, costing \$90.

Cost of Blasting Boulders, Grand Trunk Pacific Ry. The methods and costs of open cut work on the Grand Trunk Pacific Ry., are described on pages 518 and 619. The cost of blasting boulders on that work is here described.

On that work two methods were used to break up boulders, namely, block holing and mudcapping. Undermining was tried with indifferent success.

In mudcapping the rule followed was to use 1 lb. of 60% dynamite for each cubic yard of an approximately rectangular rock.

The following are three examples of the cost of blockholing boulders:

Example I:

A red granite boulder 10 x 12 x 9 ft., containing 36 cu. yd., cost:

1 48-in. drill hole	\$2.50
3 lb. 60% dynamite	33
2 fragments requiring reblasting;	

2 8-in. drill holes	\$1.20
1 lb. 60% dynamite22
Total	\$4.58

This is cost of 13 ct. per cu. yd.

Example II:

A red granite boulder 16 x 14 at top and 13 x 10 at bottom, 15 ft. deep, containing 92 cu. yd., cost:

8-ft. machine drill hole	\$ 7.25
16 lb. 60% dynamite	3.52
2 fragments requiring reblasting:	
1 12-in. hole and 1 8-in. hole	1.25
1 lb. 60% dynamite22
Total	\$12.24

This is a cost of 13¼ ct. per cu. yd.

Example III:

A black granite boulder triangular in shape, 4 x 5 x 5—5 ft. high, containing 1.1 cu. yd., cost:

1 7-in. hole	\$.50
¼ lb. 60% dynamite08
Total	\$.58

This is a cost of 52½ ct. per cu. yd.

In blockholing, Mr. McFarlane found that handdrilling was preferable to machine drilling, as a baby drill was more expensive to run than a gang of hand drillers. Although a baby drill would put down double the number of holes, especially if a lot of large boulders were exposed in the muck pile, when these outer boulders were broken up and the muckers commence uncovering big chunks in the interior of the muck pile, it took too long to set up a machine, and the muck pile was apt to slide and bury the machine. In drilling plug holes to square up the bottom of the cut, hand drillers could work without interfering with the teams and muckers, whereas a steam drill could only be used on the bottom when the muck was cleaned up.

The Cost of Breaking Boulders by a Drop Hammer. (*Engineering and Contracting*, Sept. 11, 1907.) Where derricks are used on jobs, such as quarries, cellar excavations, etc., the following device can be rigged up at a small expense, and the money it will save will quickly pay back the original cost.

A pear-shape weight, weighing from 1,500 lb. to 3,000 lb., made of cast steel, with an eye or ring in the end so it can be picked up, is raised by the derrick to a suitable height, and swung around until the weight is directly over the boulder to be broken, then by means of a line that is attached to a trip the weight is dropped on to the boulder, generally breaking it at the first drop.

The pear-shape of the weight has an advantage over other shapes in that it drops plumb. The weight of one ton is found very convenient for breaking most boulders.

With two derricks, one can place the boulders within reach of the other, which can break them up. At times the boulders are only broken in one or two pieces, but these pieces can be quickly turned over or placed by the derrick to be broken up small enough to handle. A man with a sledge will also break up some of the smaller pieces easier and cheaper than the derrick. With only one derrick the boulders must first be placed in favorable places for breaking, and after a number have been put within reach, the weight can be used to break them up.

In a quarry, large boulders that were not considered fit for dimension stone, were broken up for the crushers. The rock was hard blue granite. The weight was of steel, weighing 1,500 lb. It was raised 30 ft. before being tripped. The derricks were operated by steam, the cost per day of 10 hr. being:

One derrickman	\$ 2.00
One engineman	2.50
Three men at \$1.50	4.50
Plant, etc.	1.00
Total	\$10.00

Steam for the hoisting engine was furnished from a central boiler plant that furnished steam for the crushers, several hoists, drills, etc. An allowance of \$1 per day is made for this and plant depreciation.

In working the quarry a pile of refuse boulders amounting to 200 cu. yd. had accumulated. At odd times, when the derrick crew was not engaged, they broke up these boulders, which ranged in size from $\frac{1}{2}$ cu. yd. to about 3 cu. yd. With one derrick they had to take them out of the pile and place them for breaking with another derrick. After breaking up the stone, they had to keep the pieces cleared out of their way. This is all included in the cost of the work. The aggregate time used in breaking up these 200 cu. yd. was 30 hr. at a cost of \$30 or 15 ct. per cu. yd. Considering the material to be broken and the fact that they did not interfere with the other men working in or about the quarry, as blasting would, the cost is low.

Five examples of single stones will now be given, they too being granite. This cost does not include cleaning away the pieces, nor bringing the stones to the derrick. It is only the actual cost of breaking.

First Example. A $1\frac{1}{4}$ cu. yd. boulder was broken in 4 min. Cost 6.7 ct. or 5.3 ct. per cu. yd.

Second Example. A 1 cu. yd. boulder was broken in 5 min. The stone had to be lifted by the derrick and turned so as to bring the rift to the top. Cost 8.3 ct.

Third Example. A 2.12 cu. yd. boulder was hit twice and broken in 6 min. Cost 10 ct. or 4.7 ct. per cu. yd.

Fourth Example. A 3.3 cu. yd. boulder had to be hit 3 times before it broke, then it went into 3 pieces. Each of these had to be broken. Thus the weight was hoisted 6 times. Cost 30 ct. or 9 ct. per cu. yd.

For the five boulders, the average cost was 6.4 ct. per cu. yd. From this it is seen that in breaking up the 200 cu. yd. about two-thirds of the cost of the 15 ct. was for handling the boulders, clearing away the pieces and some little sledging that may have been done by the crew. Breaking boulders is made easier by placing a flat stone or block of wood under the piece to be broken.

The Cost of Breaking Boulders by Heating. (*Engineering and Contracting*, Feb. 24, 1909.) One method of breaking up large boulders that is not much used is by heating. The work is very simple. The boulders are heated by building a fire around and on top of them, and after the rock has become quite hot, cold water is thrown on them, with the result that the rock breaks up into several pieces that can be easily sledged into one-man stones. In clearing land for real estate development this method was used. The waste wood from the trees had to be burned, and by piling it around the boulders they were broken by being heated and cooled with water, at less than it would have cost by using explosives.

In excavating a cellar a contractor encountered four large boulders, one with 1.75 cu. yd. in it, and one with 1.12 cu. yd. The rock was mica schist. That evening two men worked overtime to break up these boulders. Discarded boards used in the runways were split up to make the fire. In an hour the stones were heated enough to break them so they could be sledged, and 15 min. more were consumed in sledging them. Thus the first breaking by heat cost 30 ct. with wages at 15 ct. per hr. and the sledging cost 7½ ct. This is a cost of 10 ct. per cu. yd. for the heating and 3 ct. per cu. yd. for sledging.

On another day a boulder having 2.25 cu. yd. in it, and one with 1.5 cu. yd. were dug out. It took two men 2 hr. to heat and break these, the extra time being needed on account of the increased size of one of the boulders. This was at a cost of 16 ct. per cu. yd. for breaking up the boulders so that they could be loaded into a wagon by hand. Nothing has been allowed for the wood as it was waste and would have been thrown away.

Comparison of Various Methods of Breaking Boulders. From the foregoing records Table LXXV has been compiled.

TABLE LXXV. COST OF BREAKING BOULDERS

Method.	Rock	No. examples.	Cost in cents, per cu. ft.			
			Min.	Max.	Average.	Av.
By sledging	Blue sandstone	7	.05	.33	.16	
By drop hammer	Blue granite	5	.18	.33	.24	
By heating	Mica schist	2	.48	.59	.55	
By blockholing	Blue sandstone	5	.41	.74	.62	
By undermining	Blue sandstone	6	.56	.78	.65	
By mudcapping	Red sandstone	4	.54	1.00	.78	
By mudcapping	Granite	3	.48	1.95	.97	} 1.28
By mudcapping	Blue sandstone	8	.72	2.54	1.70	
By mudcapping and sledging	Blue sandstone	5	.72	1.89	1.19	

It will be seen from this that the cheapest method is by sledging, but it must be remembered that the larger boulders cannot be sledged by a man, so when a boulder has a greater volume than $\frac{1}{2}$ to $\frac{3}{4}$ cu. yd., unless there is a seam or crack in it made from previous blasting, or by its natural stratification, it must be broken up by one of the other methods, which means an increased cost of from 50 to 1000%.

CHAPTER XVI

CANAL EXCAVATION

General Conditions. As a general rule no other kind of rock excavation presents such uniform conditions, such easy problems of conveying and disposing the spoil, and such fertile ground for the use of special machines as does canal excavation. The location of most canals permits the disposal of spoil at one or both sides of the channel. Fills along the line of the work, such as are frequent in railroad construction, are rarely required. This condition, therefore, leads to the adoption of machines designed to carry the spoil short distances from the bed of the canal to the side banks. The following pages present many examples of specially designed machines. The building of special machines has been done unadvisedly in some instances and an expensive and untried type of machine has been installed under conditions where well-known machines would have proved economical. An example of this is given on page 701.

The Chicago Main Drainage Canal. The illustrations of this canal originally appeared in *Engineering News*. For cost data I am particularly indebted to Mr. W. G. Potter, to *Engineering News* and to *Engineering Record*.

Excepting the Panama Canal no excavation work of such magnitude as the Chicago Drainage Canal has ever been so fully described in print; and, what is more noteworthy, no such complete record of cost has ever been published before. In view of these facts, and because such a variety of machines were used in excavating this canal, I have thought it wise to devote a large amount of space to it.

The rock section of the Chicago Canal is 160 ft. wide at the base, and has vertical sides 36 ft. high. The rock was excavated in three 12-ft. lifts, channeling machines being used to cut perfectly smooth walls. The excavation was classified as solid rock and "glacial drift"; the latter including all material other than solid edge rock. The solid rock was limestone (Niagara period), occurring in horizontal strata. The lower lift is said to have been almost twice as hard to drill and channel as the upper lift. The contractors were required to base their bids on the results obtained by borings. Mr. L. E. Cooley, the first chief engineer, intended to sink a number

of test pits, but was overruled by the first Board of Trustees, which acted under the usual cents wise and dollars foolish policy of political "boards." The borings gave an entirely misleading idea of the character of the glacial drift, and failed to indicate that much of it was an exceedingly tough hardpan of cemented gravel, and of gravel boulders mixed with clay. Several contracting firms were ruined by the subsequent action of the board in refusing to release them or to reclassify the material.

The average contract price on the "glacial drift" excavation was 30 ct. per cu. yd. and 78 ct. per cu. yd. on the solid rock. There were about 26,000,000 cu. yd. of "glacial drift" and 12,300,000 cu. yd. of rock. The prices for excavation included all bailing and draining. The contracts contained an excellent clause that required that the work done each month should be not less than such a proportion of the whole work as one month was of the total number of months agreed upon for completion of the work.

The following work was done in the years 1893 to 1896.



Fig. 149. Chicago Main Drainage Canal.

Excavating Very Tough Clay. After removing the upper layer of prairie soil, an exceedingly tough or "indurated clay" was encountered that required blasting. Boulders were found scattered through the clay, and in some cases in such quantities as to make a regular hardpan, of which I shall speak later. On one section, 14 men were kept busy drilling and blasting for one Bucyrus shovel having an output of only 350 cu. yd. per 10-hr. shift. The shovel took out a swath 12 to 14 ft. deep, and blasting holes were put down 16 to 18 ft. deep, sprung with dynamite and charged with Judson powder. On another section Barnhart AA shovels averaged 520 cu. yd. per 10-hr. shift for seven months. As high as 600 cu. yd. was averaged by a Bucyrus shovel on another section, showing that the toughness of the material varied considerably. For data as to the shovel output and cost in this clay, the reader is referred to my "Handbook of Earth Excavation."

Excavating Hardpan. The worst hardpan encountered in the Chicago Canal work is shown in Fig. 150. It consisted of boulders and stones cemented together so that a vertical face was left after blasting. The only way that this material could be loosened economically was by means of large charges of dynamite fired at the rear of small tunnels, as shown. The

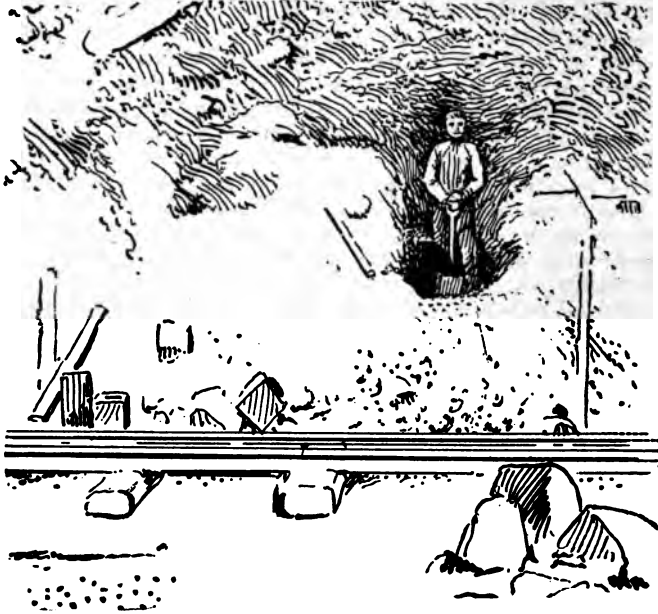

Fig. 150. Coyote Hole in Hardpan.

contractors who at first bid 28 ct. on this work subsequently secured 50 ct. a cu. yd. on a re-letting. On Section 4 of the canal there were four steam shovels; one 70-ton Osgood, one 60-ton Bucyrus and two 45-ton Bucyrus. According to the reports of the canal engineers, for October, 1894, the Osgood shovel worked 27 ten-hour shifts, averaging 406 cu. yd. per shift. The three Bucyrus shovels averaged 760 cu. yd. for the 60-ton shovel, 458 and 480 cu. yd. for the two 45-ton shovels. The general daily average for the season was 493 cu. yd. per shovel. The good record made by the smaller shovels as compared with the larger shovels was largely due to the fact that they were given the easiest material to handle, so that no conclusions can be drawn as to relative efficiencies of the respective shovels. This remark will also hold true of most of the data that follows.

The material was loaded in 3-cu. yd. Peteler dump cars, hauled on a down grade in trains of two cars by two horses to the foot of the incline and hoisted up the incline by a Lidgerwood $12\frac{1}{2}$ x 16-in. double drum engine, or by a 13 x 16-in. double drum Webster, Camp and Lane engine. Fig. 151 shows

one of these inclines. It was found that 750 ft. was the limit of economic haul from the shovel to the foot of each incline. Hence the glacial drift was taken out of the canal for a stretch 1,500 ft. long before moving the incline. Fig. 152A shows the track arrangement.

For Section 3 the track layout is shown in Fig. 152B. A Mundy 60-hp. hoisting engine hauled two 3-cu. yd. cars at a time up the incline, and a team of horses then hauled the cars to the dump. A team can haul 4 to 6 empty cars back. A Victor shovel was used on this work and its output was from 300 to 400 cu. yd. per shift, working 21 shifts per month.

Incline and Tipple. On Section 1 an incline with tipple was used for handling rock, and this was the only instance where this device was used for other material than earth. The in-

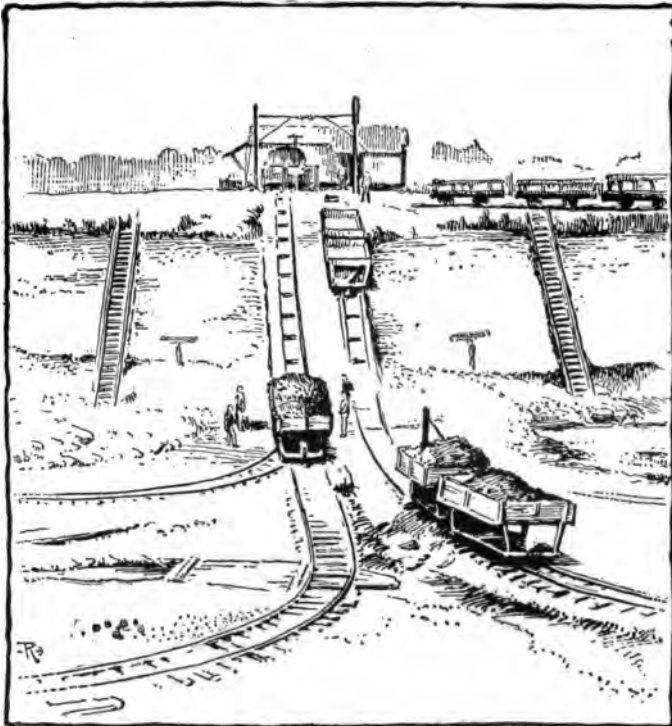

Fig. 151. Incline and Hoist.

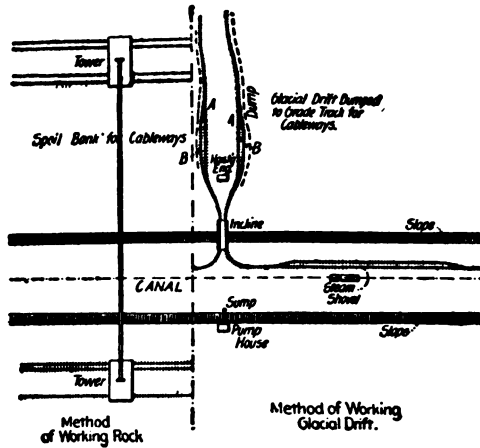

Fig. 152A.

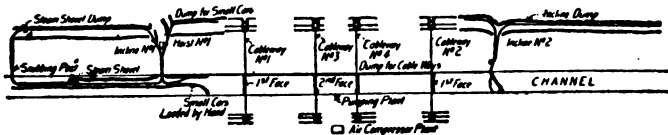

Fig. 152B.

Track Layout for Incline.

cline is of steel, with the track rising at a 30° slope. There is a trestle approach to the tippie consisting of short king post spans supported on trestle bents, which in turn rest on greased skids so that they may be slid along. Fig. 153A shows the arrangement of the inclines and track system for the rock work, also the two derricks carrying the air-hoists used in loading large rocks into the cars.

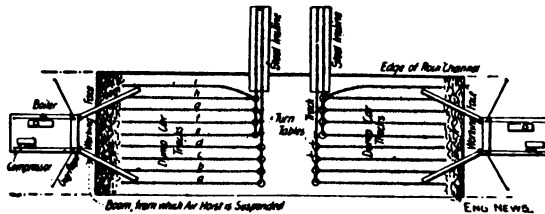

Fig. 153A. Incline and Tippie.

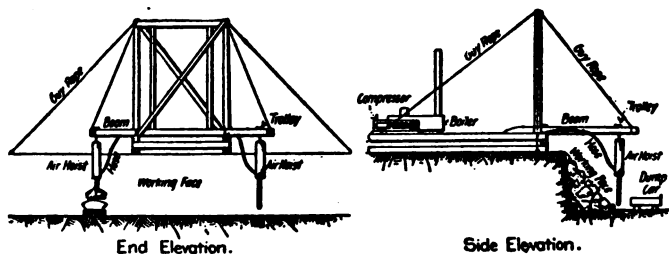

Fig. 153B. Derrick and Air Hoist.

Fig. 153B shows a derrick and two air hoists attached to two horizontal booms that swing right or left so as to cover the face of the quarry. The air hoist may be moved back or forward along the boom. Each hoist has a 12-in. cylinder 8 ft. long that is supplied with air from the compressor on the framework as shown. The compressor which has an 18 x 24-in. piston also supplies air to the drills. Six men operate the air hoists on each face changing from one hoist to the other, so that after loading the large stones on the right side, they move to the left hoist, leaving the right side free for men to load the small stones by hand into the cars. Two sets of chains and grab hooks were used with each hoist, two men handling each set of grabs. While the hoist is traveling along the boom to the car one pair of chainmen are hooking on to a rock at the face, and, while the empty hoist is returning, the other two chainmen are unhooking from the rock on the car and returning. One man runs the hoist and one tagman swings the boom and pulls the hoist back and forth. The cars when loaded are hauled by mules to the turn tables, shown in Fig. 153A, where they are transferred to the incline track, hauled up by a cable and dumped by the automatic tippie. The cars are of steel, open at the front end, and there is one car to each of the nine tracks.

The output of the two incline conveyors was as follows:

	No. 10-hr. shifts.	Cu. yd. solid rock per shift.
May	38	166
June	67	160
July	91	164
Aug.	97	187

Cost by Lidgerwood Cableway. Nineteen cableways were used on the canal, spans 550 to 725 ft. with traveling towers 73 to 93 ft. high. Mr. Charles H. Locher, of the contracting firm of Mason, Hoge & Co., invented an aerial dump, by means of which the skips could be dumped automatically. This device insured

the success of the cableway. Fig. 154 shows the traveling towers. There were 5 cables. The main cable for the carriage-way was $2\frac{1}{4}$ in. diam. and had a sag of 5 ft. per 100 ft. The hauling cable and the hoisting cable were each $\frac{3}{4}$ in.; the button cable, for distributing and supporting the fall rope carriers was $\frac{5}{8}$ in., as was also the dumping cable for dumping the load. The life of the main cable was 50,000 to 80,000 cu. yd. of solid rock, or 30,000 to 50,000 trips, or 100 to 160 days. A 70-hp. boiler and a 10 x 12-in. engine operated the cableway, giving a hoisting speed of 250 ft. and a traveling speed of 1,000 ft. per min. For shifting the towers a small hoisting engine on each tower car operated a system of blocks. The total weight of cables, cars, skips and all was about 450,000 lb., and the cost about \$14,000.

Large stones (6 to 8 tons) were chained out during the noon hour. The skip was 2 x 7 x 7 ft. of $\frac{1}{4}$ -in. boiler plate, weighed 2,300 lb. and held 1.9 cu. yd. of solid rock, although 1.6 cu. yd. was the average load. The force consisted of an engine-man, a fireman, a signalman and a "rigger" who attended to oiling and changing worn out parts, besides men loading skips. The output ranged from 300 to 450 cu. yd. of solid rock per 10 hr., handled at a cost of 28 to 30 ct. per cu. yd., including loading skips, pay of cableway crew, coal, oil, repairs and maintenance, but no interest and depreciation for plant.

Wages for 10-hr. shift were as follows: Laborers, \$1.50; foremen, \$3; engineman, \$2.75; fireman, \$1.80; towerman, \$2.70. The fireman and towerman worked 12 hr. when two 10-hr. shifts were worked each 24-hr. day. The following is the record for the month of March, 1895, on Sections 2 and 4 for four cableways, each cableway having 10 skips:

No. of cableway	1	2	3	4
No. 10-hr. shifts	49	35	52	49
Total cu. yds. rock	12,633	8,632	16,162	14,535
No. skip-loads by day shift	5,111	5,327	5,435	4,369
No. skip-loads by night shift	4,087	1,201	5,467	4,468
Cu. yd. solid rock per skip	1.44	1.32	1.48	1.65
Cu. yd. solid rock per shift	258	247	311	297
No. of laborers	27	27	32	32
No. of foremen	2	2	2	2
Total hours labor	12,861	9,608	17,075	15,227
Cu. yd. rock loaded per man per shift	9.82	8.98	9.46	9.54
Tons coal per shift	1.83	1.83	2.28	2.28

The contractors, McArthur Bros., furnished the foregoing data, also a table of percentages of cost, from which the following has been compiled by the author:

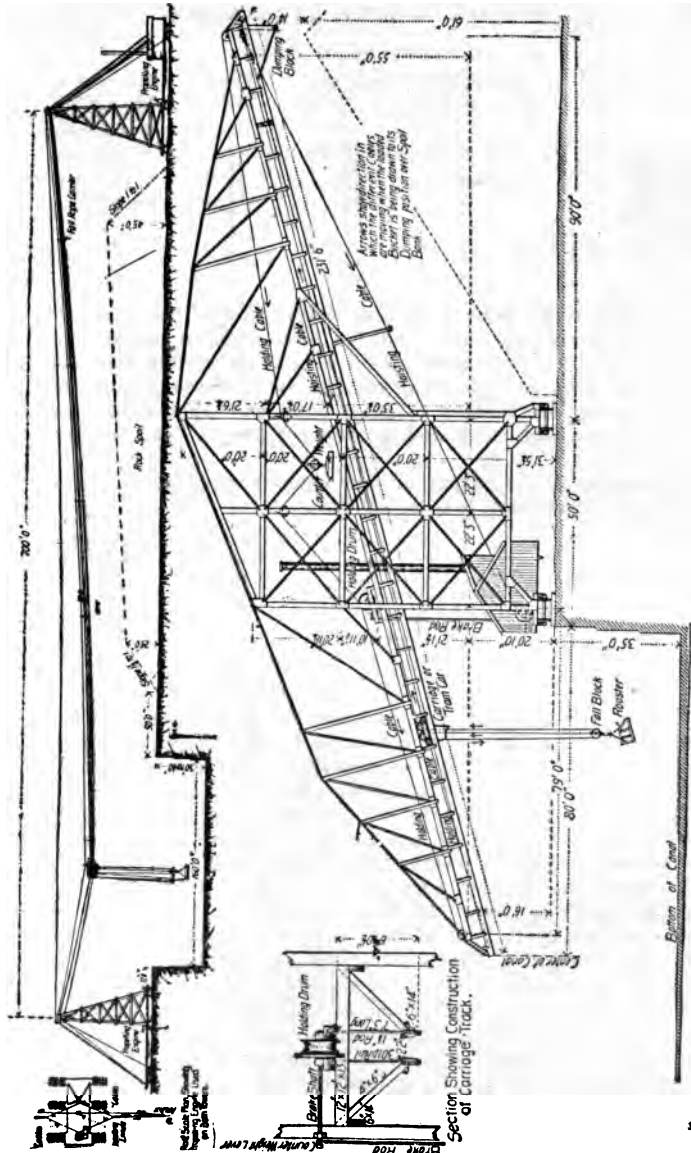

Fig. 154 (above). Lidgerwood Cableway.
 Fig. 155 (below). Hullelt-McMyler Cantilever Crane.

PERCENTAGES OF COST

	Labor (2/3).	Supplies (1/3).	Total (3/3).	Assuming 50 Cts. per Cu. Yd., Cost per Cu. Yd. in Cts.
Drilling	22	10	18	9.0
Explosives	3	58	21	10.5
Loading	46	2	31	15.5
Conveying	15	20	17	8.5
Channeling	4	3	4	2.0
Pumping	4	7	5	2.5
Supt. and gen'l. labor.	6	..	4	2.0
Total	100	100	100	50.0

The author has deduced that on one section of the canal the total labor cost two-thirds and the total supplies one-third of the cost of rock excavation, while on another section the total labor was 60% and the total supplies 40% of the grand total cost. During the months of May, June and July these same cableways on Sections 2 and 4 averaged 340 cu. yd. each per 10-hr. shift.

On Section 3 the output of four cableways, as given by the Supt. of Construction, was as follows:

	No. 10-hr. shifts.	Cu. yd. per shift.
Sept., 1894	126	294
Oct. "	140	267
Nov. "	153	230
Dec. "	140	305
Jan., 1895	173	161
May "	193	308
June "	181	308
July "	185	254

The contractors, Gilman & Co., gave the following as the output for May, which agrees very closely with the output given by the superintendent of construction: The average output working two 10-hr. shifts daily was 305 cu. yd. per shift per cableway, skips averaging 1.6 cu. yd. each; one cableway averaged as high as 346 cu. yd. and as low as 284 cu. yd. Assuming 36 laborers loading the 9 skips at each face (under one foreman), the average output per man per 10-hr. shift was 8.5 cu. yd. for the month of May. No delays are counted out, unless the men are actually laid off without pay; these delays for repairs and due to slight accidents were probably not less than 10 to 15% of the working time where two shifts were worked.

Three Rand drills worked on each cableway face, receiving air from an 18 x 30-in. duplex compressor. A single row of holes across the canal was exploded at each blast; about 500 lb. of dynamite per day being used on each face. Drilling cost 6 ct.; dynamite and blasting, 9 ct.; channeling, 7 ct., and dumping, 2 ct.; total, 24 ct. per cu. yd. Assuming 36 laborers, at \$1.50, loading skips, 2 foremen at \$3 and cable force at \$1, 2

tons coal for cableway at \$2, we have a total of \$71 per 10-hr. shift for loading and conveying, say, 270 cu. yd., or 27 ct. per cu. yd., which, added to the 24 ct. above given, makes 51 ct. per cu. yd. exclusive of plant installation, plant interest and depreciation and office expenses.

On Section 6 four cableways were used, and according to the contractors, Mason, Hoge & Co., the output was as follows for December, 1894, to March, 1895:

	No. of Shifts.	Length of Shift, Hr.	Delay for		Cu. Yd. per Cableway.	Cu. Yd. per Skipload.	Cu. Yd. per Man.
			Repairs, Hr.	Skips, Hr.			
Dec.	82	9	37	138	333	1.30	9.5
Jan.	99	9	62	197	338	1.43	9.62
Feb.	70	9	28	102	293	1.33	8.37
Mar.	92	10	91	140	345	1.50	9.86

The small size of skip load is due to the large size of the pieces. It will be seen from the above tabulation that from 2 to 3 hr. were lost through delays during each 10-hr. shift for the four cableways, or an average of nearly 40 min. each 10-hr. shift for each cableway. Other records bear out this ratio, as on Section 7 where for one cableway the average delay per 10-hr. shift was 1.08 hr. for a 3 mos. run, and on Section 8 a similar average was 1.12 hr. lost per shift. In these cases cableways were not working night shifts, so that the conditions were favorable. The Lidgerwood Manufacturing Co. calls attention to the fact that the delays are due to two items: (1) Delay for repairs to cableway; (2) delays due to water in the pit, absence of rock ready to load, and the like. The first item, they claim, is generally about one-quarter of the entire delay, and they enumerate such items as the following: Door ring leaked during the night and boiler had to be refilled; bolt broke in dumping device; main cable sheave broke; dump line broke; dump line and hoist line tangled; box of tower sheave broke; button line broke. In this way nearly 13 hr. were lost one month, while 16 hr. more were lost waiting for stone on Section 7, where due to these delays and others the average output for the month was 403 cu. yd. per shift worked, or 476 cu. yd. per 10 hr. actually run; and the month following the output was 462 cu. yd. per shift worked, or nearly 500 cu. yd. per 10 hr. actually run.

On Section 7 nine skips and about 35 men were worked on a face. About $1\frac{1}{2}$ tons of coal, costing \$2 per ton, and 25 ct. worth of oil were consumed per shift. According to official report the average output of one cableway for several months

was 332 cu. yd. per 10-hr. shift, but the contractors give an average output of 394 cu. yd. per 10-hr. shift for three months (Jan., Feb., Mar., 1895), the average skip load being 1.87 cu. yd., and the average 10-hr. output of each man loading skips being 10.1 cu. yd., assuming 35 men to have been the loading force. As a matter of fact, they worked only 9-hr. shifts, but for sake of uniformity the output has been reduced to a 10-hr. basis. The average lost time was 13% in Jan., 12% in Feb. and 6% in March.

On Section 8 a row of 20 holes is drilled 8 ft. back from the face, and 8 ft. apart, each hole being loaded with 15 lb. of 40% dynamite, breaking 28 cu. yd. of solid rock. As a consequence of this close spacing of holes, the rock was loosened in smaller sizes, and each skip load was correspondingly increased. Nine skips and 40 men loading were employed on each cableway. Locher, Harder & Williamson have furnished the following records for their two cableways for the first three months of 1895:

	No Skips, Both Cableways.	Total Cu. Yd.	Total Delays, Hr.	Total Shifts.	Cu. Yd. Output per Hr.
Jan.	10,485	17,475	80	37*	52.5
Feb.	6,869	14,809	63	30*	51.9
Mar.	8,180	13,491	64	30½	44.2

* Jan., all 9-hr. shifts; Feb., half 9-hr., half 10-hr. shifts.

The January record on this section is excellent and shows what may be done where the plant is well handled and the rock well broken up, so as to reduce the delays arising from handling large rocks with grab hooks. The average skip load, it will be seen, was 1.8 cu. yd. It should also be noted that if the average force of loaders did not exceed 40 men, each man loaded nearly 11½ cu. yd. per 9-hr. shift.

Hullett-McMyler Cantilever Crane, or Conveyor. This machine resembles the Brown cantilever crane, but instead of spanning the canal it reaches only to the center. Indeed, as first made it was designed to overhang the canal bank but 10 ft., and was then used to receive its skip load from a McMyler locomotive crane running on a track in the bottom of the canal; but this arrangement did not prove sufficiently efficient. Fig. 155 shows the general design of the Hullett-McMyler cantilever crane in its final form; and Fig. 156 shows the arrangement of two such cranes working on opposite sides of the canal. The skip is of steel and has a capacity of 3.7 cu. yd. water measure, or 1½ cu. yd. of solid rock. A 9 x 12-in. engine, working under 80 lb. pressure and with 200 rev. per min., does the hoisting. The total weight of the crane is 110 tons, and its cost is given at about \$9,000.

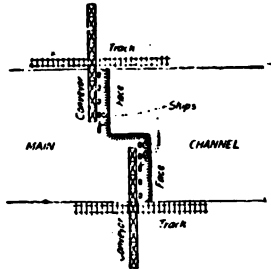

Fig. 156. Arrangement of Cranes on Canal.

Only two of these cranes were used on the canal (on Section 7). The daily (10-hr.) expense of operating each was:

1 engineman	\$2.50
1 fireman	1.50
Machinist service	1.00
Superintendence	0.75
1 ¼ tons coal	2.50
Oil and waste	0.25
Repairs	0.50
Track maintenance	1.50
Night watchman	0.50
Total	\$11.00

The two cantilever cranes handled 168,470 cu. yd. solid rock in 337 10-hr. shifts, or 250 cu. yd. per shift per machine.

Hullett-McMyler Derrick. These derricks were at first placed in the bottom of the canal, but were afterward enlarged and placed on the berm, Fig. 157. No locomotive crane had ever before been made with so long a boom. The derrick handles a skip weighing 2,400 lb., making, with its full load of 1½ cu. yd. solid rock, 3½ tons loaded. The machine was designed to handle safely a load of 10,000 lb. The derrick weighs 95 tons, and its cost is given at \$15,000. A craneman, a fireman, a man to trip skips, 3 laborers hooking and unloading skips, 25 loaders and a foreman constitute the crew for each derrick. The cost of operation is practically the same as for the Hullett-McMyler conveyor.

In the pit 3 men were busy hooking and unhooking skips of which there were 5 or 6 to each machine. The highest daily output of which record is given was made Mar. 18, 1895, when 605 skips, or 980 cu. yd., of solid rock were conveyed in 10 hr. by the two machines. To load this rock there were 59 laborers in the pit, so that each man handled 16.6 cu. yd. that day. All told, these two conveyors moved 279,300 cu. yd. in 492 10-hr. shifts, averaging 568 cu. yd. (284 cu. yd. each) per shift.

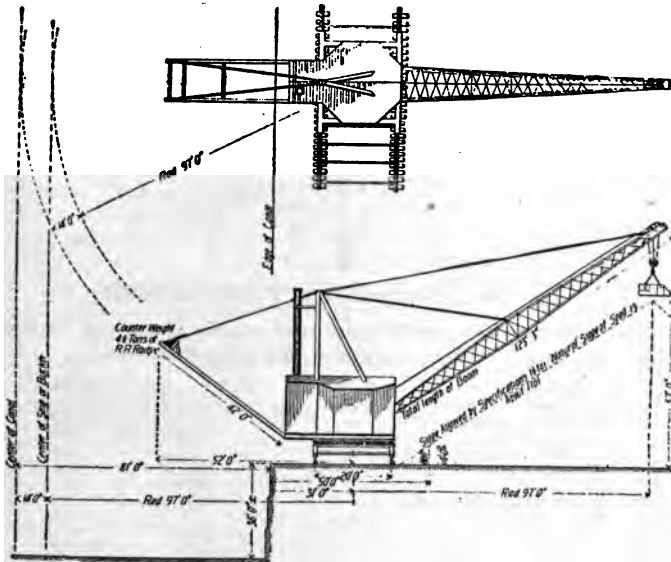

Fig. 157. Hullett-McMyler Derrick.

Geraldine Double-Boom Derrick. Four of these derricks were used on the canal, the general appearance of each being shown in Fig. 158. The derrick revolves on a turntable, having a rack 28 ft. diam. in which two pinions mesh and are rotated

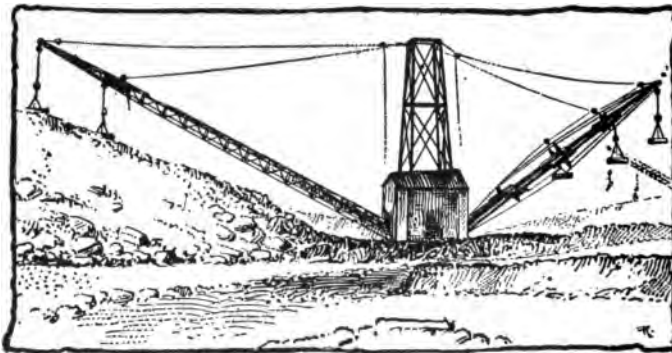

Fig. 158. Geraldine Double-Boom Derrick.

by two 8 x 8-in. vertical engines. The apex of the tower is 113 ft. above the track. The booms are 155 to 164 ft. long, and each boom carries two fall blocks for lifting the skips. While one boom overhangs the canal the other overhangs the spoil bank. As soon as two skips are hooked on in the pit the engineman begins to raise them, and at the same time to swing the derrick. The skips upon reaching a certain height are dumped automatically. Hoisting is then stopped, while the opposite skips, which have been lowered, are unhooked and loaded skips hooked on. Twelve skips holding 2 cu. yd. each are used. The daily cost of operation is:

50 laborers at \$1.50	\$75.00
2 foremen	6.00
1 engineman	2.50
1 fireman	1.50
2 trackmen	3.00
2 tons coal	4.00
Oil, water, watchman and supt.	5.00
Total	\$97.00

The output of four derricks for 5 mos. ending July, 1895, was 300 cu. yd. solid rock per derrick per 10-hr. shift, which would indicate that there were many delays, since if 50 men were engaged in loading the 300 cu. yd. the average per man must have been only 6 cu. yd. The best average for any one of these derricks for one month of this time was 439 cu. yd. per 10-hr. shift.

The Brown Cantilever Crane. The cantilever crane manufactured by the Brown Hoisting & Conveying Co., of Cleveland, Ohio, had been used for many years for handling iron ore, coal, etc., along the Great Lakes and elsewhere, so that its success on the Chicago Canal might have been regarded as a foregone conclusion. However, the output of this device and its general efficiency far exceeded expectations. Altogether eleven of these cranes were used on the canal, and after the first year a monthly output of 15,000 to 16,000 cu. yd., or 600 cu. yd. per 10-hr. shift per crane, was attained; in fact, for a week one crane handled 892 cu. yd. per 10-hr. shift, or 4,845 cu. yd.

Fig. 159 shows the general design of one of these cantilever cranes. The cantilever trusses have a slope of $12\frac{1}{2}$ deg. and are 355 ft. from end to end. A carriage or trolley travels along the track on the lower chord of the truss, the hoisting power being a $10\frac{1}{2}$ x 12-in. engine and a 120-hp. boiler. The skip can be dumped automatically at any point of its 343 ft. travel. The weight of the entire machine is 150 tons, and its cost about \$28,000.

Each skip has a capacity of 75 cu. ft. water measure, and carries 1.5 to 1.7 cu. yd. of solid rock. The average traveling

speed of the skip is 150 ft. per min., although the maximum speed is 400 ft. per min. On Section 10 the contractors, E. D. Smith & Co., have furnished the following record of output for the month of March, 1895, for one crane working in the lower lift, using 9 skips:

Number of 10-hr. shifts	25
Output per shift, cu. yd.	520
Number of laborers on the face	48
Output per laborer per shift, cu. yd.	10.4
Av. skip load of solid rock, cu. yd.	1.6

There were two foremen, one crane engineer, one fireman, one oiler for crane and one towerman or operator; 2 to 2½ tons of coal were burned per shift. Mr. C. L. Harrison, the division engineer, gives the output of three cranes on this section for six months of 1895 (Feb. to July inclusive) as having been 205,900 cu. yd. in 421 shifts (10-hr.), or nearly 490 cu. yd. per crane per shift; during the month of April the average output for each of the three cranes was 542 cu. yd.

On Sections 11, 12 and 13 there were eight cantilever cranes operated by the manufacturers, who sublet the conveying of the loaded rock. These cranes handled 2,084,700 cu. yd. of solid rock in 3,609 shifts (10-hr.), or very nearly 500 cu. yd. per crane per 10-hr. shift. In the first 12 months (Feb., 1894, to Jan., 1895) the average output was 485 cu. yd. per crane per 10-hr. shift and 10.9 cu. yd. per man loading skips. The lost time per crane per 10-hr. shift for one month, of which record is given, was about 2 hr., of which about ½ hr. was due to the crane and the other 1½ hr. to the failure of the contractors to have stone ready to load, which is probably a fair average. In Dec., 1895, these eight cranes working one 9-hr. shift a day averaged 60.5 cu. yd. per hour. For the 12 mos. each of these eight cranes averaged 23 shifts a month; in mid-winter working 9-hr. shifts, and in mid-summer 11-hr. shifts, although the records have all been reduced to a 10-hr. shift unit.

The daily cost of operating each crane was as follows:

Engineman	\$3.00
Fireman	2.50
Oiler	1.75
Operator	2.75
1.67 tons of coal at \$1.75	3.00
Oil, water and waste (estimated)	0.50
Laying track (estimated)	0.50
Total	\$14.00

It will be seen that the conveying cost about 3 ct. per cu. yd., not including plant interest and depreciation. No other method of conveying equaled this in low cost of operation, and it should also be noted that track had to be laid along only one berm of the canal; but, on the other hand, the price charged

for a cantilever crane was considerably in excess of that charged for any other machine. If \$28,000 represents the price of each crane and 260,000 cu. yd. of rock were handled by each crane, obviously the contractor would be compelled to charge nearly 11 ct. per cu. yd. against the crane, unless he could be sure of a definite salvage price for the crane at the end of the job. Considerations of this kind are too often overlooked in estimating the unit cost of work.

Cost by Car Hoist Inclines. For conveying rock in dump cars there were three methods used: No. 1, the fixed incline with spur tracks; No. 2, the natural incline with a loop track, and No. 3, the double-hoist and diagonal incline.

Method No. 1. This method was used on Sections 8, 11, 12, 13 and 15 of the canal. A number of spur tracks were laid in the cut up to the rock face, and a number of spurs were laid on the dump, no spur being over 150 ft. long, and all connecting by switches with the main track, which led up a fixed trestle incline. This incline had a slope of 30 deg., 40 ft. of it being in the canal prism and 85 ft. up on the berm. A hoisting engine was located at the head of the incline. Single cars (of which there were 8), each holding 1 cu. yd. solid, were loaded by hand, hauled by a mule to the foot of the incline, hoisted by the engine and hauled by a mule to the dump. The average haul (one way) from pit to dump was about 600 ft. The pit force was 40 to 45 men loading, 1 water boy, 1 mule and driver, and 1 foreman. The dump force was 1 hoist engineer, 1 hoist runner, 1 mule and driver, and 4 dumpmen. The incline was torn down whenever it had to be shifted.

Method No. 2. On Section 10 the upper lift was taken out by a car hoist method that differed from all others in that there was only one (3-ft.) gage track on the dump, a loop in the pit and practically no trestling on the incline. The empty cars descended by gravity around the loop, and one incline served two working faces. The wedge of earth and rock which was left to support the track on the incline was removed in carts after the incline had served its purpose and had been moved. The main track on the incline was 150 ft. long; at a distance of about 75 ft. back from the canal it branched, the two tracks coming down over the berm and meeting at the far side of the canal, forming a loop 375 ft. long. This method of track arrangement gave a very short haul and the track was easily maintained. There were 3 trains of 4 side-dump cars each, two being loaded, while the third was at the dump; and each car held $1\frac{1}{2}$ cu. yd. of solid rock. When a train was loaded the cable was attached and it was hauled up the incline. The pit force consisted of 35 loaders, 1 water boy, 1 cableman, 1 switch-

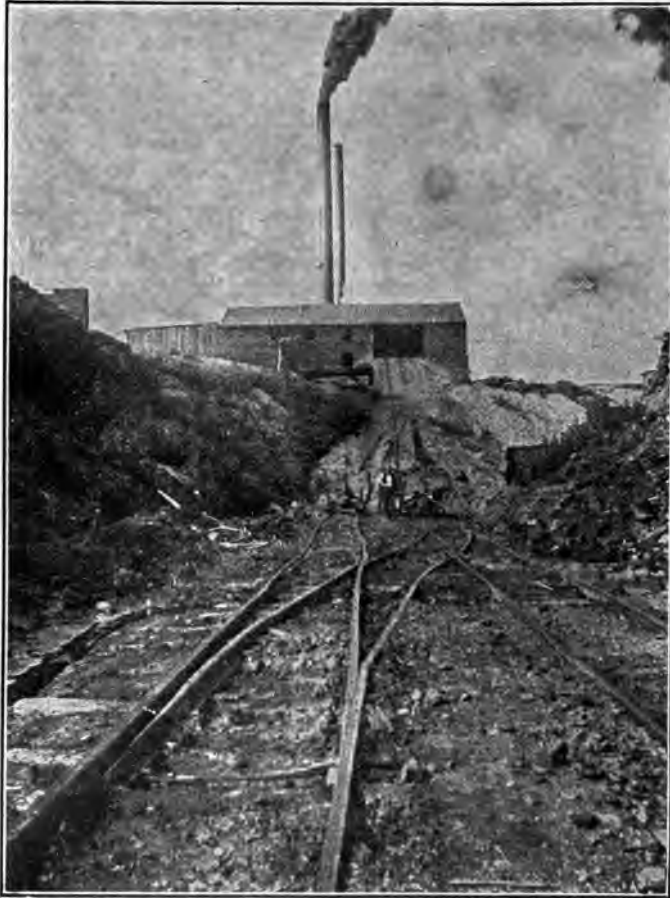

Fig. 160. Incline for Car Hoist.

man and 1 foreman. The dump force was 1 hoist engineer and 4 or 5 laborers.

Method No. 3. Double Hoist and Diagonal Incline.—This was the only car hoist method used for all three lifts. A double track trestle incline entered the pit diagonally—not at right angles with the canal, like other inclines. The two working faces were also diagonal, making an angle of 30° with the

canal, thus giving a longer loading time. The track layout is shown in Fig. 161. There were two parallel main tracks on the incline trestle, each 150 ft. long; then each track was 300 to 800 ft. long in the pit and 600 to 1,000 ft. on the bank. The average haul was about 700 ft. Two trains of 12 cars were used on each face, so that there was no delay in loading. There were sidings in both pit and dump. Each car held $\frac{1}{2}$ cu. yd. of solid rock. A double-drum hoisting engine handled two cables, one for each track. The pit force working two faces consisted of 75 loaders and sledgers (1 sledge to 6 loaders), 3 teams, 2 water boys and foremen. The dump force was 1 hoist engineer, 1 fireman, 3 teams and 10 dump men.

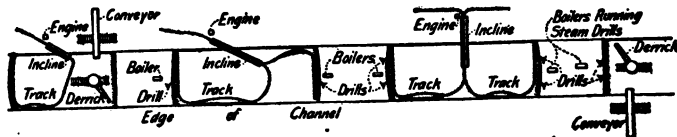

Fig. 161. Track Arrangement and Incline.

Summary of Chicago Canal Costs. The summary in Table LXXVI has been compiled by Mr. W. G. Potter. The wages for the different classes of workmen are given elsewhere in this chapter, common laborers in all cases receiving \$1.50 for 10 hr. work, all delays of 1 hr. or more being docked. The tabulated costs do not include shop repairs, but do include field repairs. The drilling item appears not to include the cost of drill sharpening. Plant interest and depreciation is not included either—a very important item where such expensive machines are used. Explosives include caps and dynamite, 12 ct. per lb. for the 40% dynamite being assumed to cover the entire cost of explosives. General expenses include superintendence, watchmen and incidentals. The three methods of car hoist, Nos. 1, 2, and 3, have been described in the pages just preceding.

TABLE LXXVI. COST IN CENTS PER CU. YD. (SOLID)

	Channeling.	Drilling.	Explosives.	General Ex- pense.	Pumping.	Conveying.	Pit Force.	Dump Force.	Total.
Brown Cantilever	3.9	4.1	8.0	3.2	1.0	3.6	14.6	0.0	38.3
Lidgerwood Cableway.	3.7	3.8	8.4	2.7	1.0	3.6	15.6	0.0	38.8
Hullett-McMyler Der- rick	3.9	4.0	7.4	2.5	1.8	5.3	18.3	0.0	43.2
Hullett Conveyor	4.1	3.7	8.5	3.8	1.2	6.2	21.4	0.0	48.9
Car Hoist No. 1	3.7	3.9	9.1	2.7	0.8	3.1	24.8	5.1	53.1
Car Hoist No. 2	3.9	3.6	8.9	3.2	0.9	1.2	22.9	2.3	47.1
Car Hoist No. 3	4.0	5.0	10.7	3.1	1.2	1.2	26.4	4.8	56.5

TABLE LXXVII

	Section.	Cu. Yds.	Cu. Yds. per 10 Hrs.	Cu. Yds. per Man in Pit per 10 Hrs.
Brown Cantilever	10	443,750	478	10.45
Lidgerwood Cableway	8	600,725	397	10.25
Hullett-McMyler Derrick ..	7	180,406	217	8.52
Hullett Cantilever	7	109,397	235	9.91
Hullett Conveyor	9	178,839	335	6.85
Car Hoist No. 1	8	131,674	285	6.96
Car Hoist No. 2	10	60,341	269	6.98
Car Hoist No. 3	9	308,531	463	6.82
Double Boom Derrick	14	324,880	282	8.22
St. Paul Derrick	14	63,700	153	8.22

Cost of Channeling. Channelers had never been used on canal excavations before the building of the Chicago Canal. The object in using them on the canal was to secure smooth side walls that would offer little resistance to the flowing water. The limestone varied widely in hardness, the upper lift being as a rule much easier to channel than the lower lifts. There were three lifts of 12 ft. each, and the channel cut was offset 6 in. at each lift. Naturally the lower lifts were somewhat shattered by the blasting of the upper lift, adding to the difficulty of channeling. The average weight of a channeler was 11,000 lb.; it moved back and forth on a section of track 30 ft. long, striking 250 blows per min. The width of the channel cut by the bit was 2½ in. at the top, decreasing ¼ in. for each 2 ft. of depth. The speed of channeling was 130 to 200 sq. ft. per 10 hr. on the upper lift, and about half as much on the second and third lifts.

There were 53 Sullivan and 33 Ingersoll channelers. The following are records of efficiency:

	Sullivan Channeler.			
	No. 101.		No. 111.	
	June, 1893.	Jan., 1894.	June, 1893.	Jan., 1894.
No. hours worked	205	222	209	299
Sq. ft. channeled	2,783	1,401	3,076	1,683
Av. sq. ft. per hour	18.4	6.3	14.2	5.6
Max. sq. ft. per day	3001	1263	3572	963
Min. sq. ft. per day	90	183	632	123
	1 10-hr. day; 2 11-hr. day; 3 9-hr. day.			

Labor troubles in June reduced the number of shifts worked, but the work was done on the top lift under the most favorable conditions. The work done in January was under the most unfavorable conditions, on the third lift, with ice and snow, frozen water pipes, etc.; and 5 night shifts were worked with No. 111. The time (hours worked) is that for which the men were paid, and includes all time lost for repairs and delays. The labor and fuel expense of running a channeler was as follows per day:

	Per Day
1 runner	\$2.75
1 helper	1.50
Blacksmith and teams hauling steel	0.70
1 fireman	1.75
Superintendence and machinist	1.80
1½ tons coal	2.50
Total (excluding interest and deprec.)	\$10.50

The Ingersoll-Sergeant Drill Co. has furnished the following record of work of 5 channelers for the month of May, 1894, working on the top lift: The average cut by each machine for 27 working days was 2,279 sq. ft., or 121 sq. ft. per day. As high as 221 sq. ft. were cut by one machine in a day, and the best of these 5 channelers averaged 148 sq. ft. a day for the month. The cost of operation was:

	Per Day
1 runner	\$3.00
1 helper	1.50
1 fireman	1.75
Coal	3.00
Blacksmith, machinist	1.50
121 sq. ft. at 8.9 ct	\$10.75

For an excavation 160 ft. wide the cost of channeling, at this rate, was slightly less than 3 ct. per cu. yd. These figures, however, apply only to firm limestone in the top lift, and 30 to 50% should be added to this cost for the lower lifts.

Seven channelers on Section 9 working 7 mos. in 1894 averaged 94 sq. ft. each for the three 12-ft. lifts. Lewis gives the cost of channeling on Section 3 as being 7 ct. a cu. yd., which would be equivalent to about 20 ct. a sq. ft. *Engineering News* gives the average for the whole canal work as 8 to 10 sq. ft. an hour at a cost of 8 to 25 ct. a sq. ft., and places the average cost at about 17 ct. a sq. ft., or 6 ct. a cu. yd. of rock excavated.

Mr. W. G. Potter gives the following data for Jan. 1, 1894, to Feb. 1, 1895, on ten sections:

Section	Sq. ft.	Days (10-hr.).	Ct. per sq. ft.	Sq. ft. per day.
No. 7	98,043	1,170	11.73	83.80
No. 8 (1st lift)	42,000	300	7.50	140
No. 8	201,658	2,339	11.10	86.2
No. 9	182,167	1,992	12.16	91.4
No. 10	202,192	2,638	11.81	76.6

Time is actual working time, all delays of 1 hr. or more deducted. Shop repairs are not included. Wages per 10 hr. were:

	No. 7	No. 8	No. 9	No. 10
Channelerman	\$3.00	\$3.25	\$3.25	\$2.75
Fireman	1.75	1.75	1.75	1.75
Laborer	1.50	1.50	1.50	1.50
Team (occasional)	3.50	3.50	3.50	3.50
Foreman (for entire sec.)	2.75	2.75	2.75	...
Coal, oil and waste	1.75	2.25	2.25	1.75

Cost of Drilling. Compressed air was used on 9 out of 15 sections of the canal. The common installation was a large compressor located at the center of a section, delivering air at 80 to 90 lb. pressure. An 8 or 10-in. main led to the canal berm and there branched, a 6 or 8-in. main going each way; 2-in. feed pipes, 175 to 230 ft. long, supplied three drills. The common size of drill was one with a $3\frac{1}{4}$ x $6\frac{1}{2}$ -in. cylinder, and a 2-ft. feed screw; + and X-bits were used, the X-bit being better. For a 12-ft. hole the starting bit was 2 ins. diam. According to W. G. Potter the expense per drill per 10-hr. shift was about as follows:

	Steam.	Air.
Drill runner	\$2.00	\$2.00
Drill helper	1.50	1.50
$\frac{1}{2}$ fireman	0.50	(air) 1.50
Coal and oil	1.25	(oil) .10
Total	\$5.25	\$5.10

On Section 9 the daily average for 6 months was 82 ft. of hole per drill for each of 15 Ingersoll-Sergeant drills; each hole being 12 ft. deep. Holes were spaced 6 to 12 ft. apart; close spacing decreasing the cost of sledging, but increasing the cost of drilling.

Explosives. Many grades of dynamite were tried, but finally 40% was found to be the best. The higher grades shattered the rock in the immediate vicinity of the holes, but threw down chunks that were too large to handle. The sticks of dynamite were $1\frac{1}{2}$ x 6 in. in size, weighing $\frac{3}{4}$ lb. each; and 10 to 25 sticks were charged in a hole, thus consuming 0.6 to 1.2 lb. of 40% dynamite per cu. yd. Including fuse and caps the dynamite averaged about 12 ct. per lb.

Steam Shovel Output, Chicago Canal. Steam shovels were not much used for loading rock, as their average output was small. On Section 15 a 20-ft. face was worked, and 5-cu. yd. cars were loaded by two Bucyrus (55-ton) shovels with broad, shallow dippers having a capacity of $2\frac{1}{4}$ cu. yd. Cars were hauled in trains of 10, one locomotive serving each shovel. The best record made by one shovel was 600 cu. yd. of solid rock in 10 hr. The combined output of these two shovels was as follows:

	No. of 10-hr. Shifts.	Cu. Yd. per Shovel per Shift.	Total Cu. Yd., Solid Measure.
1895.			
May	109	266	29,000
June	99	291	28,850
July	96	302	29,000
Aug.	102	310	31,800

The average per shovel per month was 14,700 cu. yd., working two shifts a day.

The Panama Canal. The following brief outline and summaries of the methods and costs of work on the Panama Canal have been compiled from articles in *Engineering and Contracting*. (See particularly a 48-page article in the Jan. 7, 1914, issue of that journal.) The subject is of such magnitude and the reports and costs of the various items of work are given in such detail that it is impossible in this chapter to give more than a brief outline and a few examples typical of the character of the undertaking.

The total length of the canal is about 50.5 miles, of which about 40.5 miles are on land, the remaining 10 miles constituting the approach channels at each end. Beginning at the Atlantic end the first 4.5 miles consist of a channel 500 ft. wide, 41 ft. deep, with sides at a slope of 1 on 3, within the bay of Limon. Following this is the inshore channel 2.5 miles long, and of the same dimensions as the submerged channel, continuing to Gatun. At Gatun the Chagres River is dammed by an earth dam with a crest 105 ft. above sea level. This dam impounds the water and forms Gatun Lake the surface of which is 85 ft. above sea level. Three twin locks connect the inshore channel with Gatun Lake. Gatun Lake extends as far as Obispo, and, except for the removal of an occasional mound, furnishes a channel without excavation for 17 miles. This channel is 1,000 ft. wide and 75 ft. deep for 3.5 miles, and with the same width but a gradually decreasing depth for 4.5 miles more. The channel continues at the same width for 7 miles, and then narrows to a width of 800 ft. for 4 miles, and then to 500 ft. for 1 mile which brings it to Gamboa.

Near Gamboa is Bas Obispo and here the canal is formed by the Culebra (or Gaillard) cut through the continental divide. At Bas Obispo the channel is reduced in width to 300 ft. and continues at this width for 8.1 miles. As the channel enters the cutting beyond Bas Obispo the height of the banks increases to summits at Contractors Hill of 410 ft. elevation and at Gold Hill of 554 ft. elevation. These two summits are, however, just off the line of the canal; the greatest elevation directly over the canal line is 312 ft., or since the bottom of the canal is 40 ft. above sea level at this point, the actual depth of cut on the center line is 272 ft. The depth of water in the cut is 45 ft. at normal lake level. The canal extends on this level to Pedro Miguel. At Pedro Miguel is the first of the locks dropping the canal level to the Pacific.

This twin lock drops the level 20 ft. to Miraflores Lake which is formed by a dam at Miraflores. The channel continues through the lake for 1.5 miles with a width of 500 ft. and a depth of 45 ft. to Miraflores lock. At this point two twin locks drop the

channel to Pacific sea level. The channel from Miraflores to deep water in the gulf of Panama is 7.5 miles long 500 ft. wide and 45 ft. deep.

The work was done by government forces, very little work being performed on contract. Working shifts were 8 hr.

General Statistics and Equipment. The general statistics of the Panama Canal work and the equipment in use during 1910 are given in the following tables:

GENERAL CANAL STATISTICS.

Length from deep water to deep water	50 ½ miles.
Length on land	40 ½ miles.
Bottom width of channel, maximum	1,000 ft.
Bottom width of channel, minimum, 9 miles, Culebra cut	300 ft.
Locks, in pairs	12
Locks, usable length	1,000 ft.
Locks, usable width	110 ft.
Gatun Lake, area	164 sq. m.
Gatun Lake, channel depth	85 to 45 feet.
Excavation, estimated total	174,666,594 cu. yd.
Excavation, amount accomplished April 1, 1910	103,205,666 cu. yd.
Excavation by the French	78,146,960 cu. yd.
Excavation by French, useful to present canal	29,908,999 cu. yd.
Concrete, total estimated for canal	5,000,000 cu. yd.
Time of transit through completed canal	10 to 12 hours.
Time of passage through locks	3 hours.
Relocated Panama railroad, estimated cost	\$7,225,000
Relocated Panama Railroad, length	46.2 miles.
Canal zone, area	about 448 sq. m.
Canal zone area, owned by United States	about 322 sq. m.
French buildings, number acquired	2,150
French buildings, number used	1,537
French buildings net value when acquired	\$1,959,203
Value of utilized French equipment	\$1,000,000
Canal force, actually at work	about 39,000
Canal force, Americans	about 5,500
Cost of Canal, estimated total	\$375,000,000
Work begun by Americans	May 4, 1894
Date of completion	Jan. 1, 1915

SCHEDULE OF EQUIPMENT.

Canal Service

Steam shovels:	
103-ton	14
95-ton	32
70-ton	35
66-ton	7
45-ton	10
26-ton	1
Trenching shovel	1
Total	100
Cars:	
Used with unloading plows	1,806
Steel dump	1,800
General service	525
Total	4,131
Locomotives:	
French	119
American	160
Total	279

Unloaders	30
Spreaders	24
Track shifters	10
Cranes	35
Pile drivers	16
Dredges:	
Rebuilt French ladder	7
Dipper	3
Pipe-line suction	6
Sea-going suction	2
Total	18
Subaqueous rock breaker	1
Tugs	9
Towboat	1
Tender	1
Clapets	12
Barges	39
Panama Railroad.	
Locomotives	68
Cars:	
Coaches	56
Freight	1,495
Locomotive cranes	4
Pile drivers	2
Tugs	2
Crane boat	1
Lighters, steel	14

Rates of Wages and Force. The wages paid in 1905 were approximately as follows: Steam shovel crews: foreman, \$100 per month; pit foreman, \$75 to \$100; enginemen, \$190; crane-men, \$165 and bonus; pitmen, \$75. Steam and air drill crews: foremen \$100 to \$125; workmen, \$75 to \$83.33. Carpenters: foremen, \$100 to \$125; workmen, \$75 to \$100. Other wages were as follows: Supervisors, \$150; general foremen, mining, \$100; timekeepers, \$50 to \$100; machinists, 45 ct. per hr.; yardmaster, \$130; switch enginemen, \$83 to \$100; work train conductor, \$100; unskilled labor, 80 ct. to \$1.04 per day in gold.

In 1907 the wages paid were as follows: Steam shovel enginemen, \$210 per month; crane-men, \$185; firemen, \$83; locomotive enginemen, \$210; conductors, \$190; yardmasters, \$210; unloader enginemen, \$125; track throwing enginemen, \$125; pile driving enginemen, \$125; pumpmen, \$50 to \$135; foremen, \$100 to \$175.

On March 23, 1910, the total force of the Canal Commission and Panama Railroad Co., actually at work, was 38,732, divided as follows:

	Gold	Silver	Total
Isthmian Canal Commission	4,499	26,217	30,716
Panama R. R. Co. (proper)	557	3,336	3,893
Panama R. R. relocation	158	3,000	3,158
Panama R. R. commissary	215	750	965
Total	5,429	33,303	38,732

The "gold force" was made up of officials, clerical force, construction men, and skilled artisans of the Canal Commission and

the Panama R. R. The "silver force" represented the unskilled laborers. Of these about 5,000 were Europeans, mostly Spaniards, with a few Italians and other races. The remainder, about 28,000 were West Indians, about 4,000 of whom were employed as artisans receiving 16, 20 and 25 ct., and a small number, 32 and 30 ct. an hr. The standard rate of the West Indian laborer is 10 ct. an hr., but a few of these doing work of an exceptional character were paid 16 and 20 ct. The larger part of the Spaniards were paid 20 ct. an hr. and the rest 16 ct.

Panama Canal Lock Excavation.

Gatun Locks. The Gatun locks occupy a site on the flank of the eastern hills bordering the Chagres valley at Gatun. The highest elevation of the natural surface on the site was about +30, and the lowest was approximately +5. Borings showed, beginning at the south end of the site, a rising stratum of argillaceous sandstone, whose lower slopes were covered with clay, but which became exposed near to the north end of the middle locks. Under this stratum was a stratum of conglomerate, and a stratum of soft sandstone, and then argillaceous sandstone mixed with tufa.

The excavation was begun in 1907 and was performed by channeling the sides of the pits, drilling and blasting the rock cores between channel cuts, excavating and loading the spoil by steam shovel and hauling the spoil by train to make enrockment in Gatun Dam. As the final levels were approached hand excavation was employed to prevent shattering of the rock floor and unfitting it to receive the concrete footings and floors. Rock excavation was virtually completed on June 30, 1911, and amounted to the following quantities:

Method.	Cu. yd.	Unit Cost
Steam shovel	4,555,395	\$0.605
Hand	186,425	1.728

The overburden of clay which covered the sloping rock beyond the south end of the dam site had to be removed to rock for portions of the flare walls and the south approach wall. This was done by dredging, and it cost for some 975,000 cu. yd. about 32 ct. per cubic yard, including the cofferdams required.

Pedro Miguel Locks. Borings on the site of the Pedro Miguel locks showed firm rock to exist well below the lock bottom. The method of excavation was essentially the same as that employed at Gatun and the spoil was deposited in the Pedro Miguel dam. The total volume of steam shovel excavation was 1,130,236 cu. yd., and it cost 91.1 ct. per cu. yd. The hand excavation preparing foundations amounted to 160,621 cu. yd. and cost \$2.73 per cu. yd.

Miraflores Locks. Borings on the site indicated hard lime-

stone under the upper locks and argillaceous limestone under the lower lock. As at Gatun and Pedro Miguel, excavation methods were channeling, drilling and blasting, steam shovel and hand excavation. Spoil from the site was deposited in the Miraflores dam. The steam shovel excavation in the lock site amounted to 2,222,582 cu. yd., and cost 92.9 ct. per cu. yd. Hand excavation preparing foundations amounted to 366,933 cu. yd. and cost \$1.83 per cu. yd.

Culebra Cut. Of the several structural features of the Panama Canal, the Culebra Cut doubtless holds first place in public opinion. This judgment is not far in error from the viewpoint of the engineer. The date of the possible completion of the cut set from the first the date of the completion of the canal. It was known also from the first that it was the most expensive single feature of the canal work. These estimates of magnitude, moreover, were based on the 53,000,000 cu. yd. estimated excavation of the Minority Report of the International Board of Consulting Engineers. In 1902 the decision to widen the channel through Culebra added over 13,000,000 cu. yd. to the theoretical excavation. Then the slides began to develop and every year saw them add several million yards to the work until finally on July 30, 1913, over 93,000,000 cu. yd. had been removed from the cut. The final amount will be still greater.

General Methods. The general method of excavating Culebra Cut can be stated in a few words. The excavation was dry cut through earth and rock, about 71% of the yardage requiring blasting. The problem was the same as that at any rock cut for a railway in the United States, but it was that problem magnified many times. The rock was broken up by blasting and excavated and loaded into cars by steam shovels, and the cars were hauled in trains to waste dumps or to where the spoil could be utilized in other construction. The rock was taken out in cuts parallel to the canal axis. The shovels on short tracks worked against a face or bench; the trains which received the spoil stood on tracks parallel to the benches, and these loading tracks connected with main tracks leading to the places of spoil disposal. The drills worked ahead of the shovels.

The work separates for consideration into the following items: Drilling and blasting; steam shovel operation; transportation; spoil disposal; excavation records; excavation costs; slides and methods of handling them.

Drilling and blasting. The general plan pursued was to drill lines of holes parallel to the benches and blast down the faces. This general plan was of course subjected to many modifications to meet conditions that developed and called for changes in detail.

CANAL EXCAVATION

675

The drills used were of two general types, cable well drills and percussion drills and with few exceptions they were operated by compressed air. Drilling operations prior to July 1, 1907, were of moderate extent and the great bulk of the drilling had been completed by July 1, 1912. The record of drill work in detail will therefore be confined to the five years of major operations. It is tabulated as follows:

Items:	1907-1908.	Amounts.
241 tripod drills, ft. hole		1,224,902
66 cable drills, ft. hole		613,568
Hand drilling, ft. hole		210,461
Total hole drilled, ft.		2,048,931
Yardage		8,106,716
Yards per ft. of hole		4
1908-1909.		
269 tripod drills, ft. hole		2,062,482
143 cable drills, ft. hole		1,306,970
Hand drilling, ft. hole		267,243
Total holes drilled, ft.		3,636,695
Yardage		12,622,880
Yards per ft. of hole		8.5
1909-1910.		
233 tripod drills, ft. hole		2,019,176
153 cable drills, ft. hole		2,063,067
Hand drilling, ft. hole		272,461
Total hole drilled, ft.		4,354,704
Yardage		12,158,996
Yards per ft. of hole		2.8
1910-1911.		
227 tripod drills, ft. hole		2,274,080
155 cable drills, ft. hole		2,317,962
Hand drilling, ft. hole		308,347
Total hole drilled, ft.		4,800,389
Yardage		11,672,241
Yards per ft. of hole		2.4
1911-1912.		
230 tripod drills, ft. hole		2,368,804
150 cable drills, ft. hole		2,243,194
Hand drilling, ft. hole		243,302
Total hole drilled, ft.		4,855,300
Yardage		12,862,968
Cu. yd. per ft. of hole		2.6

The total length of hole drilled during the five years was 3,730 miles, or, adding the footage drilled prior to July 1, 1908, and after June 30th, 1912, something over enough to reach to the center of the earth.

Explosives and Blasting. The Culebra excavations required some 3,000 tons of explosives per year. Prior to June, 1908, explosives received from the manufacturers in the United States were stored at Bas Obispo and at Gold Hill. About the date named two concrete block storehouses were erected, one at Mindi

and one at Gamboa. Each of these stores comprised a 300-ton dynamite magazine, a detonator house and a watchman's house. With the installation of these stores a system of explosives service was established as follows: One month's supply plus 25% was maintained in each magazine and one month's supply was kept in transit from the United States. The bulk of the explosive was 60% and 45% dynamite but several patented explosives and also powder were used in smaller amounts. The cost of dynamite during 1911 was 11.7 ct. per lb. for 45% and 12.7 ct. per lb. for 60% dynamite.

The quantities of explosives used during the five years, July 1, 1907, to July 1, 1912, were as follows:

Year:	Tons.	Lb. per cu. yd.
1907-08	2,352	0.64
1908-09	3,365	0.59
1909-10	3,157	0.49
1910-11	2,638	0.50
1911-12	2,603	0.45

The general method of blasting was to fire a series of vertical holes parallel to the face of the bench and a series of toe holes drilled horizontally at or nearly at the foot of the bench. Until June 30, 1908, all holes were fired by blasting batteries of the usual magneto-electric type, but so many miss-fires resulted that an electric firing current wire was strung the entire length of the cut. To this wire 45 blasting spurs about 1,000 ft. apart were connected. Each of these spurs terminated in a 5-kw. 110-volt transformer with a switch box and secondary leads. From the switch box No. 4 triple insulated wire was laid on the ground in the cut, and all blasting operations were performed by wiring fuses in parallel and connecting them to the leads of No. 4 wire. The current used was a 60-cycle, 2,300-volt current which the transformers stepped down to 110 volts. This arrangement practically eliminated misfires. Blasting batteries were subsequently used for springing holes, or for firing isolated groups of a few holes. As a further precaution against miss-fires due to defective caps, all powder men were supplied with galvanometers and required to test caps before wiring and after the holes were connected up for blasting. These precautions reduced accidents to a very few. During the three years, June 30, 1909, to June 30, 1912, with over 18,800,000 lb. of explosives fired only five men were killed by explosions.

Summary. The records made public permit no very detailed analysis of the drilling and blasting at Culebra, but the following data reported at various times give some indication of performance. The drilling and blasting costs based on yardage actually mined and not on yardage excavated were as follows:

CANAL EXCAVATION

677

Year—	Per cu. yd.
1908-09	17.36 ct.
1909-10	17.27 ct.
1910-11	16.49 ct.
1911-12	15.23 ct.

From data covering the twelve months to July 1, 1912, it is found that the average number of feet drilled per tripod drill per day was 41 ft., at an average operating labor cost of 9 ct. per ft. For cable well drills the daily average was 50 ft. of hole drilled at an average operating labor cost of 6.7 ct. per ft. The average depth of vertical hole was 19 ft. and the average charge per hole was 24 lb. of explosives; the average length of toe hole drilled was 15 ft. and the average charge per hole was 30 lb. An average of 2.21 cu. yd. of material was broken up per pound of explosive used. These included "dobe" shots or "mud caps." There were 31,227 "dobe" shots fired during the year at a charge per shot of 6.76 lb. of explosive and blasting material. Detonators and safety fuse were used for firing. The cost per "dobe" shot averaged 90 ct.

Steam Shovel Operation. All blasted rock at Culebra was excavated and loaded onto trains by steam shovels. These machines were used in varying numbers and of different sizes and to present their performance it is necessary to subdivide it into years of record. The five years from June 30, 1907, to June 30, 1912, having included the great bulk of all steam shovel work are alone considered.

Five sizes of shovels were employed as follows:

Name—	Dipper capacity.
45-ton Bucyrus	1 ¾ cu. yd.
70-ton Bucyrus	2 ½ cu. yd.
95-ton Bucyrus	5 cu. yd.
No. 60 Marion	2 ½ cu. yd.
No. 91 Marion	5 cu. yd.

The number of each type used each year varied; the number of all shovels used each year and the average output of all shovels are as follows:

Year—	1907-08	1908-09	1909-10	1910-11	1911-12
Shovels worked	59	75	61	52	46
Number working days	305	304	304	304	304
Cu. yd. per day	932	1,199	1,231	1,314	1,319
Cu. yd. per month	23,685	30,371	31,185	32,635	33,038
Cu. yd. per hour at work	199	225	236	241	246
Cu. yd. per hour under steam ..	121	150	156	166	165

These performance records and all others which will be stated are based on an 8-hr. working day. The best performances per day, month and year of steam shovels of the sizes named above for the five years are as follows:

Item —	45-ton Bucyrus.	70-ton Bucyrus.	95-ton Bucyrus.	No. 60 Marion.	No. 91 Marion.
High daily date	Feb. 5 '08	Mar. 19 '12	Mar. 23 '10	Apr. 18 '08	June 21 '09
High daily yardage	1,856	2,900	4,465	1,904	3,485
High monthly, month	July '08	Mar. '09	Mar. '10	Mar. '08	Aug. '08
High monthly, yardage	27,713	58,048	70,290	41,219	58,419
High monthly, days worked	26	27	26	26	25
High annual yardage	105,740	300,872	543,481	441,927
High annual days worked	131	254	296	299

CANAL EXCAVATION

679

The following data shows the April, 1912, record of steam shovel No. 225 at Panama which was working in a Borrow Pit at Folks River, excavating rock for filling at the Cristobal Terminal Docks:

Quantities of Excavation (63% Rock, 37% Earth).		Cu. yd.
By cor measurement		59,580
By cross section		53,050
By cross section, rock		33,520
By cross section, earth		19,530
Average per car		8.91

Operation Report.

Days worked	26
Hours under steam	200
Hours worked	138
Per cent. of time under steam that shovel worked	69
Average daily output, cross section measurement	2,122

Cause.	Delays.	Hours and minutes.	Per cent. of time under steam.
Mining		4.25	2.2
Cleaning track		2.30	1.3
Repairs		5.00	2.5
Waiting for cars		12.30	6.3
Switching		13.35	6.8
Derailements		1.30	.7
Moving up shovel		18.55	9.5
Cutting out (once)30	.2
Waiting for steam		1.50	.9
Cleaning slide from shovel		1.15	.6
Total		62.00	31.0

Maintenance of Shovels. Steam shovels were maintained by shop and field repairs. Prior to Oct. 1, 1909, all shop repairs of steam shovels were made at the Empire shops and were in charge of the Mechanical Division and all field repairs were made by the construction division. On the date named the Empire Shops were removed from the direction of the Mechanical Division, and were made virtually steam shovel repair shops for the whole canal.

A field repair system was begun Nov. 5, 1907, and it comprised a force of boiler workers, pipefitters, machinists and helpers who made all repairs at night after the shovels were shut down. The force was divided into three gangs, each covering a certain section of the excavation. A machine shop car, equipped with a forge, drill and shaper and carrying necessary small tools, and a locomotive crane constituted the field repair plant. The field repairs included replacing and repairing circles, booms, dippers and dipper sticks, A-frames, hoisting drums, main and propeller shafts, swinging drums, intermediate shafts, water tanks, feed pumps and trucks and in one or two cases even renewal of boilers. In fact it was seldom that a shovel was sent to the shops for repairs short of complete overhauling. The numbers

of shovels repaired per night by the field repair gangs ran from 14 to 20.

The cost of repairs per steam shovel per service day from June 1, 1910, to July 1, 1912, was as follows:

Six months to July 1, 1910	\$27.66
July 1, 1910, to July 1, 1911	22.21
July 1, 1911, to July 1, 1912	22.95

Transportation. All spoil from Culebra was removed by railway. The railway consisted of three to four running tracks through the cut and connected with the Panama R. R. Service tracks connected the various shovel cuts with the running tracks and spurs from the Panama R. R., led to the various places where spoil was wasted or used for construction. Because of the volume of spoil and of the speed with which it had to be removed all running track and main track train operations were directed by a train dispatcher and assistants.

The track system for the service of the Culebra Cut varied from time to time in mileage and location. Exclusive of the Panama R. R. track, it comprised track in the canal prism, track west of the canal, track east of the canal and tracks on dumps. The following table shows the track mileage of each class for each of the five years to July 1, 1912:

Location —	1907- 1908.	1908- 1909.	1909- 1910.	1910- 1911.	1911- 1912.
In canal prism	51.56	68.98	73.08	76.11	72.93
East of canal	30.63	29.45	25.51	37.83	32.13
West of canal	43.91	39.79	43.52	30.49	27.65
Dump track	43.84	56.10	58.14	64.73	54.75
Total	169.94	194.32	200.25	209.16	187.46

These totals of trackage give only a partial idea of the track work required. Each year many miles of track had to be renewed, laid new and shifted. An idea of the amount of this work is furnished by the approximate figures that follow:

Items.	1908-09	1909-10	1910-11	1911-12
Track removed	135	213	152.9	146.47
Track laid	160	219	215.08	227.13
Track renewed	10	20
Track shifted	1,534	1,534	1,430
Frogs and switches removed	573	556	590	638
Frogs and switches laid	612	927	1,169	1,096

The excavation and car equipment for handling spoil increased gradually to about a maximum in 1909-10 and then decreased. During the maximum year the motive power and rolling stock assigned to the Central Division, virtually to the Culebra Cut, was as follows:

Cars—	No.
Decauville (industrial)	363
Steel, " Western "	419
Steel, " Oliver "	288

CANAL EXCAVATION

681

Cars —	No.
Steel, " Goodwin "	12
Steel, " Ingoldsby "	12
Total	1,104
Locomotives —	
Decauville	2
19 x 24 in.	111
18 ½ x 23 ½ in.	25
20 x 26 in.	19
Others	4
Total	161

Not all of the locomotives were used in hauling spoil and not all were in service at any one time. The following gives for the three years for which records are available the average number of locomotives working per day and their assignments:

Consignment —	1909-10	1910-11	1911-12
Handling spreaders	7.8	6.35	5.85
Handling unloaders	10.97	10.23	10.03
Handling track shifters	4.35	3.64	2.92
Handling trains	125.50	126.24	117
Totals	148.62	146.46	135.80

The cost of locomotive repairs per service day for the corresponding three years was as follows:

1909-10	\$6.94
1910-11	7.88
1911-12	8.57

The average number of cars loaded per day with excavated material and the largest number handled any one day are as follows:

	1909-1910		1910-1911		1911-1912	
	Av.	Max.	Av.	Max.	Av.	Max.
Flat	2,156	2,648	2,268	2,569	2,403	2,674
Large steel dump	193	179	325	446	320	224
Small steel dump	1,179	1,946	1,147	2,166	973	1,948
Totals	3,528	4,773	3,740	5,181	3,696	4,846

The cost of car repairs per car per working day for the corresponding three years was as follows:

1909-10	\$1.30
1910-1187
1911-1275

The following table of car measurements was used in the Central Division of the Isthmian canal construction work as a basis for calculating yardage during 1908:

Lidgerwood flats20 cu. yd.
Large Western dumps17 cu. yd.
Small Western and Oliver dumps10 cu. yd.
French dumps	5 cu. yd.

Spoil Disposal. Spoil from Culebra Cut was disposed of at waste dumps and in making construction fills at various points

along the canal work. To July 1, 1912, 94,544,885 cu. yd. of material had been wasted at 55 separate places, the amount deposited at one place ranges from about 1,000 cu. yd. to 16,000,000 cu. yd. The main dumping grounds were as follows:

Tabernilla	16,077,847 cu. yd.
Gatun	8,709,116 cu. yd.
Miraflores	10,441,841 cu. yd.
Balboa	13,861,817 cu. yd.
Panama R. R. fills	7,125,682 cu. yd.

The spoil disposed of at Gatun was employed in forming the enrockments for the Gatun dam, and that disposed of along the Panama R. R. was for the reconstructed line of that road. The three great spoil dumps were at Tabernilla, Miraflores and Balboa, and from 10,000 to 20,000 cu. yd. daily could be wasted at each of these dumps.

Generally, structural fills were made from trestles, as at the Gatun dam, using dump cars. At dumps the general method of procedure was as follows: A trestle was constructed and spoil was dumped from it until it was filled to track level, and as far out as possible on the sides. The track was then shifted right or left to the embankment edge and the trains were unloaded by Lidgerwood unloaders which plowed the spoil off the cars and onto the edge of the dump. Spreader cars were then used to plow the piled up spoil over the edge of the dump. When the spreader cars had reached the limit of the plow arms, the track was again shifted to the dump edge. For this work track shifting cars were employed; these cars were provided with booms and shifted the track by power. As indicating the speed of disposal at these dumps the following figures are given showing the amount of material dumped per day at the larger places of deposit:

Dump —	1908- 1909	1909- 1910	1910- 1911	1911- 1912
Tabernilla, cu. yd.	20,000	16,052	3,316
Miraflores	10,000	10,218	11,443	9,450
Balboa	11,000	11,997	15,286	12,929

The special equipment for unloading spoil at dumps comprised 14 spreaders, 36 unloading plows, 6 track shifters and 28 Lidgerwood unloaders. The cost of repairs to this plant per service day averaged as follows:

Item —	1909-10	1910-11	1911-12
Unloaders	\$20.55	\$14.80	\$14.45
Spreaders	17.30	14.77	14.24
Track shifters	6.67	2.25	2.77
Unloading plows	3.79	3.30	2.46

Excavation Records. Culebra Cut excavation as recorded is not separable from total excavation in the Central Division but so great a part was it of the whole that output and cost records

for the Central Division are virtually records for Culebra Cut. The total yearly excavation from the Central Division canal prism to Jan. 1, 1913, has been as follows:

Year —	Cu. yd.
1904	60,107
1905	741,644
1906	1,506,562
1907	5,570,432
1908	13,459,378
1909	18,442,624
1910	17,806,111
1912	12,582,124
Total	70,168,982

There was estimated to remain on July 1, 1913, 9,280,237 cu. yd. to be excavated. Of the total yardage given above something over 72% has been rock. The average and maximum monthly outputs for each year of heavy work, that is beginning with the year 1907-8, have been as follows:

Year —	Average cu. yd.	Max. cu. yd.
1907-08	973,771	1,216,264
1908-09	1,024,288	1,966,294
1909-10	1,483,843	1,987,714
1910-11	1,162,423	1,623,152
1911-12	1,419,774	1,712,225
1912-13	1,648,510

Excavation Costs. The cost of excavation on the Central Division for each of the five years ending June 30, 1912, was as given in Table LXXVIII.

The yardage on which these costs were based are not those given in the annual yardages as tabulated above; they were as follows:

1909	19,067,777
1910	17,674,804
1911	18,592,692
1912	17,063,446

TABLE LXXVIII. COST PER CU. YD.

Class of work —	1908-09	1909-10	1910-11	1911-12	1912
Loading, steam shovel	\$.1150	\$.1001	\$.0888	\$.0707	\$.0081
Loading, hand3993	.3442	.2567	.3056
Drilling and blasting1413	.1149	.1190	.1048	.1157
Transportation1854	.1452	.1522	.1414	.1331
Dumps1344	.0911	.0657	.0541	.0479
Tracks1190	.0838	.1001	.1014	.0855
Division office and supervision0163	.0114	.0150	.0120	.0142
General surveys0008	.0001	.0003	.0002
Clearing site0004	.0048	.0046	.0005	.0001
Division structures0002	.0012	.0013	.0005	.0003
Drainage and sumps0052	.0038	.0041
Total division cost7128	.9519	.8964	.7461	.7176
General and administration1882	.1049	.0646	.0457	.0361
Plant, arbitrary1300	.1300	.1300	.1000	.0395
Total per cu. yd.	\$1.0310	\$1.1868	\$1.0910	\$.8918	\$.7932

The costs of Table LXXVIII are as reported by the Division Engineer. The following shows for two years, 1911 and 1912, costs itemized somewhat differently by the cost-keeping accountant.

	1911	1912
Clearing	\$.0001
Drilling	\$.0503	.0535
Blasting0547	.0622
Loading0493	.0492
Tracks1014	.0855
Transportation0816	.0734
Dumps0488	.0423
Pumps0038	.0041
Maintenance of equipment0875	.0243
Plant, arbitrary1000	.0394
Division expenses0128	.0145
Administration0462	.0364
Total per cu. yd.	\$.6364	\$.4879

The average cost of all excavation in the Central Division to July 1, 1913, based on 107,139,181 cu. yd. total, has been 71 ct. per cu. yd. Of this total 93,305,975 cu. yd. have been removed from Culebra Cut.

Slides. All estimates of excavation in Culebra Division have, due to the development of slides in Culebra Cut, been increased each year of report. The original estimate of the minority of the International Board of Consulting Engineers was in round figures 53,700,000 cu. yd. The decision in 1908 to increase by 100 ft. the bottom width of the Culebra Cut added 13,000,000 cu. yd. The revised estimate of cost of the canal made about that time was 78,000,000 cu. yd. The increases since have been:

June 30, 1910	7,330,525
June 30, 1911	4,676,278
June 30, 1912	4,614,925
June 30, 1913	9,280,237
Total	25,901,965

The bulk of the total increase has been due to the developments of rock slides in Culebra Cut.

The rock of Culebra Cut is structurally weak and badly faulted. Its natural slope is from 1 on 5 to 1 on 10, and the original slope planned for the sides of the cut was about 3 on 2. As the excavation deepened leaving high unsupported banks, the rock at places sought its natural slope by sliding. These slides were due to familiar causes and in nature are no different from rock slides in numerous cuttings in the United States; their significance is no different and their only element of distinction is their immense size.

The amount of material removed from slides compared with total excavation is as follows:

CANAL EXCAVATION

685

Years.	Total excav., cu. yd.	From slides, cu. yd.	Pct. slides of total.
1904-1909	40,983,366	3,227,059	7.87
1910	17,865,809	2,649,563	14.83
1911	18,552,644	4,879,378	26.30
1912	17,143,067	5,915,000	34.50
1913	12,773,388	5,899,200	45.40

No plan of treatment of slides has proven thoroughly effective when once they have developed, except that of excavating and hauling away the material comprising the moving mass until the slide came to rest upon reaching the angle of repose of the particular material then in motion. This angle of repose varied greatly in different parts of the cut, depending not only upon the character of the material involved in the slides but also upon the angle of inclination of the strata and upon the angles at which the numerous dikes crossed the cut. At the Cucaracha slide the angle of repose is a trifle steeper than 1 on 5; near the center of the Culebra west slide the material still moved on a slope of 1 on 7. In one or two slides the sliding material continued to move on slopes of 1 on 10.

The slides have at times ceased movement and then begun moving again; the most notable example perhaps being the Cucaracha slide, which on June 30, 1912, was stationary, and began moving again on June 20, 1913, and forced some 2,000,000 cu. yd. of material into the canal prism. The amounts of material removed from the several large slides to July 1, 1913, and the amounts then remaining to be removed were:

	Acres.	Removed.	Remaining.
Cucaracha50	3,859,500	1,500,000
West Culebra65	8,687,600	2,390,000
East Culebra55	5,966,200	2,000,000

Stream Diversion and Drainage. The Culebra Cut forming the low point for many square miles of territory, and coinciding for a considerable distance with the Obispo River valley, would naturally collect vast quantities of water were steps not taken to prevent it. The course of the Obispo River was artificially changed, beginning at the point where it approached the cut. The total length of the new river channel as originally built was $5\frac{1}{4}$ miles, from a point on the east side of the Culebra Cut, near the foot of Gold Hill, to a point clear of the cut, and finally discharging into the Chagres River. On account of slides encountered during construction work, the Obispo diversion gave way, and the flow of the river entered the cut for three days, causing inconvenience and damage. A new diversion channel was constructed with great speed. That the Obispo diversion was no small problem may be noted from the fact that in six years a total of 1,200,000 cu. yd. of excavation was necessary, of which nearly 40% was in rock, and the total cost was over \$1,000,000.

The Camacho diversion on the opposite side of the cut was similarly built. These two diversions took waters which flowed toward the Atlantic. The Rio Grande River formerly flowed through part of the area to be excavated on the Pacific side of the Continental Divide. It was similarly diverted, and a dike was constructed across the south end of the canal to prevent access of the river water. Keeping water out of the cut also kept out the silt which would inevitably have come down with the freshets. The elevation of the bottom of the cut was 40 ft., which was lower than the Chagres River, and a dam was built across the cut with its crest at elevation 73 to prevent the river from flowing into it.

The natural streams being thus prevented entering the work, it only remained to get rid of the water which originated along $8\frac{1}{4}$ miles of cut. This was done by means of centrifugal pumps at low points in the cut, which discharged the water over the dams. Excavation at a new level was always preceded by the cutting of a pioneer trench down the middle of the canal, in which all the water was collected and carried to the pumping stations. The summit during construction was at Culebra. Drainage to the south was carried to Pedro Miguel and after August, 1911, was carried through the center wall culvert of the locks. Drainage to the north was disposed of by pumping.

Power Plants, Panama Canal. All lighting of the Panama Canal work, quarters and service buildings was by electricity. Electric power was also employed for blasting operations, for operating the lock construction plants, for shop cranes and for scores of miscellaneous uses. This current was generated in power plants located at Balboa, Empire, Miraflores, Gatun and Gorgona. The output and cost of current production for the years of record were as follows:

Year.	Kw.hr.	Ct. per kw.h.
1909-10	7,027,675	3.17
1910-11	24,546,295	2.64
1911-12	25,785,910	2.24

Oil fuel was used at all stations. Current was generated by steam turbines at Gatun and Miraflores, by non-condensing engines at Empire and Gorgona and by condensing engines at Balboa. The current generated at Gatun and Miraflores was employed nearly entirely for power.

Air Compressor Plants. Compressed air for drilling and other power service was supplied to the Panama Canal work by four principal plants located at Las Cascades, Empire, Rio Grande, and Balboa. The equipment of these plants was changed and added to from time to time and except to state that all was of the best modern high power compressed air machinery, this equipment will not be listed.

The compressed air produced in 1907-8 amounted to about 275,000,000 cu. ft. of free air per month and cost from 5.3 ct. to 3.44 ct. per 1,000 cu. ft. During the fiscal years June 30, 1908, to July 1, 1912, the production and cost of compressed air was as follows:

Year.	Thousands of feet.	Ct. per 1,000 cu. ft.
1908-09	4,935,110	3.29
1909-10	7,227,204	4.03
1910-11	8,261,199	3.24
1911-12	8,795,157	3.12

The compressed air main and service lines ran into miles and a schedule of it would serve no important purpose. All air was compressed to 100 lb. per sq. in.

Shop Facilities and Service, Panama Canal. One of the first tasks undertaken after American occupation of the Canal Zone was the provision of shop facilities by renovating the old French shop buildings and equipment and by adding new buildings and plant. By July 1, 1908, the system of main shops had been completed and shop service had been systematized. It consisted of main shops located at Gorgona, at Empire and at Paraiso. As the work progressed these main shops were supplemented by a chain of local repair shops. By July 1, 1910, the list of shops had reached about its maximum and was as follows:

Location.	No. employees.
Atlantic Division —	
Porto Bello	243
Cristobal dry dock	865
Gatun Locks	260
Gatun Dam	42
Central Division —	
Empire	369
Pacific Division —	
Coculi	117
Balboa	385
Mechanical Division —	
Gorgona	1,184
Pedro Miguel	190
Las Cascades and Gamboa	96
Quartermaster's Department —	
Lirio planing mill	44
Total	3,795

In addition to the above list, general repair shops with a force of 595 men were maintained at Cristobal by the Panama R. R. Also there were numerous small shops employing five or six men, distributed around the work when required and doing drill sharpening and blacksmithing. Finally there were several cars and barges equipped as machine shops and engaged in repairs to steam shovels and floating equipment.

The cost of repairs to steam shovels, locomotives, cars and other principal plant are given in foregoing pages, in the various

tabulations of cost of work where the plant was used. Besides repair work the Gorgona shops did a large amount of manufacturing, particularly foundry work. The following table gives the amounts and cost of wire and brass castings for a number of years:

Year.	Iron.		Brass.	
	Lb.	Ct.	Lb.	Ct.
1906-07	3,590,798	3.91	202,424	18.35
1907-08	4,279,237	3.59	216,947	19.51
1908-09	4,586,342	2.9	333,416	16.51
1910-11	8,715,671	3.12	453,548	17.92
1911-12	7,476,014	2.87	350,711	18.11

The cost of repairs per cubic yard of work for the years of record were:

	1909-10	1910-11	1911-12
	Ct.	Ct.	Ct.
Dry excavation	7.95	8.68	8.31
Wet excavation	7.15	4.79	6.76
Concrete	17.41	2.06	17.48
Sand	27.89	24.44	18.71
Stone	24.10	25.13	21.68
Dry fill65	3.09	5.73
Wet fill	5.87	2.70	3.93

All repair shops were discontinued as fast as the progress of the work made them unnecessary. All useful equipment of these shops was transferred to the permanent shops being constructed at Sosa Hill in connection with the Pacific terminal plant. As planned the permanent shops proper consist of 18 buildings for the machine, erecting, and toll shops; forge shop, steel storage shed; boiler and shipfitter shop, general storehouse, paint shop, car shop, planing mill, galvanizing plant, lumber and equipment shed, pattern storage, foundry, coke shed, boiler house, roundhouse, gas house, paint house, and sand house. In addition to an office building there will be 9 auxiliary buildings.

Crushed Stone, Panama Canal. Rock suitable for concrete could not be obtained from the canal excavation except at the expense and trouble of careful sorting. It was decided therefore, to develop special quarries. The considerations to be regarded in selecting these quarries were: That the quantity of stone available should be ample, that its quality should be suitable, and that the location should be such as to permit of the most economical transportation from the crusher plant to where the stone was to be used. The yardages and costs per cubic yard relate to loose measure of crushed stone.

Gatun Locks. A quarry location at Porto Bello, about 20 miles east of Colon, best satisfied the conditions governing stone supply for the concrete lock and spillway work at Gatun. Here a quarry of ample volume and of good material could be developed close to the shore and its product could be transported

in barges to Colon harbor and up the old French Canal to unloading wharves and storage piles adjacent to the Gatun Locks. Some 2,000,000 cu. yd. of stone were needed for the Gatun work and explorations at Porto Bello indicated some 20,000,000 cu. yd. available of good andesite rock. The quarry site was also favorable, being a hillside rising directly from the water on the north shore of Porto Bello Bay.

The general development of the plant was as follows: Stone was to be taken only above elevation + 88, which was made the level of the crusher house floor, as the rock above this level to a vertical face along the + 160-ft. contour would give 4,000,000 cu. yd. The crusher house was 53 x 70½ ft.; down the slope at elevation 40 ft. was located a 51 x 57½-ft. engine house and further down at about elevation 20 ft. was located a 45 x 80½-ft. boiler house. On the flat close to the shore were located storage bins; these were connected by inclined conveyor with the crusher house and could chute from their water side directly into barges. The crusher plant consisted of six No. 6 and two No. 9 gyratory crushers and later a No. 21 crusher was added.

The rock was stripped of its earth overburden, the soil being washed into gullies which intersected the hillside. The rock was drilled and blasted, using first cable well drills and later tripod percussive drills, and was loaded by steam shovel into 6-yd. cars hauled in train to the crusher house floor and dumped. In the blasting operations generally 60% dynamite was used, the charge per hole being varied to suit local conditions of rock. Vertical, toe and breast holes were used. The vertical holes were drilled 24 ft. deep.

Quarrying and crushing were begun March 2, 1909, and crushed stone production ceased on April 30, 1913, the total production of the plant having been 1,921,579 cu. yd. of crushed stone. On Jan. 1, 1910, exact cost keeping was begun and the cost of quarrying at Porto Bello from that date to the close of operations on April 30, 1912, was as follows:

	1909-10	1910-11	1911-12
Cubic yards	404,024	864,033	440,413
Stripping	\$.0360	\$.0174	\$.0040
Drilling0875	.0450	.0431
Blasting2949	.1980	.1622
Loading1596	.0921	.0774
Transportation1086	.0758	.0669
Tracks0601	.0464	.0340
Power0447	.3259	.0353
Maint. equipment0776	.0951	.0621
Plant arbitrary3401	.3350	.4897
Total	\$1.2091	\$.9367	\$.9747

The cost of crushing the quarried rock for the same period was:

HANDBOOK OF ROCK EXCAVATION

	1909-10	1910-11	1911-12
Cubic yards	404,924	864,033	440,413
Crusher operation	\$.0559	\$.0355	\$.0283
Stone bins and conveyors ..	.0413	.0311	.0168
Power0481	.0394	.0462
Maint. equipment0573	.1158	.0827
Plant arbitrary1851	.1726	.2524
Total	\$.3877	\$.3944	\$.4264

Summarizing the quarrying and crushing costs we get for cost of stone production at Porto Bello the following:

Year	Per cu. yd.
1909-10	\$1.60
1910-11	1.33
1911-12	1.40

These costs do not include any charge for general administration.

For the year ending June 30, 1911, and the succeeding ten months ending April 30, 1912, records were kept of crushing plant performance with the results as follows:

Delays, per cent.	1910-11	1911-12
Repairs to crusher	1.84	.58
Repairs to cross conveyors ..	2.93	.54
Repairs to bin conveyors	2.58	.59
Waiting for stone	7.25	30.60
Crusher choked	1.17	.56
Waiting for barges	5.93	13.63
Other delays	5.64	3.71
Total delays, %	27.34	50.16
Total time worked	72.66	49.84

Waiting for stone and waiting for barges were the chief causes of delay.

The stone from the bins was chuted into steel barges of 700 cu. yd. capacity and towed to Colon Harbor and then inland through the old French canal and a dredged channel to unloading docks on the East Diversion, near Gatun. Barges tied up to the west wharf were unloaded by duplex cableways which transported the stone to a 200,000 cu. yd. stock pile. The cubic yard cost of towing and unloading stone from Porto Bello for the period Jan. 1, 1910, to April 30, 1912, was:

	1909-10	1910-11	1911-12
Towing, cu. yd.	404,924	864,033	440,413
Operation of tugs and barges \$.1660	.1592	.1557
Maint. equipment0666	.1063	.1267
Plant arbitrary2240	.1975	.1794
Total per cu. yd.	\$.4566	\$.4630	\$.4618
Unloading			
Cableway operation	\$.1697	\$.1168	\$.0987
Maint. equipment0692	.0929	.0224
Power0166	.0195	.0608
Plant arbitrary1731	.2050	.3441
Total per cu. yd.	\$.4280	\$.4342	\$.5280

CANAL EXCAVATION

A final summary of the cubic yard cost of stone production, including general administration charges, is as follows:

	1909-10	1910-11	1911-12
Quarrying	\$1.2091	\$.9867	\$.9747
Crushing3877	.3944	.4264
Towing4566	.4630	.4618
Unloading4286	.4342	.5260
Division expense0854	.0551	.0269
Total per cu. yd.	\$2.5674	\$2.2834	\$2.4158
Official totals	2.6283	2.3403	2.4952

The official totals of cost of all crushed stone in storage at Gatun include a considerable yardage transported by rail to storage, for which there was an additional charge. The performance of the unloading cableways at Gatun for the two years ending June 30, 1912, was as follows:

	1910-11	1911-12
Cu. yd. handled	742,408	346,767
Cu. yd. per strand per hr. worked	42.77	52.74
Cu. yd. per strand per hr. under pay	21.14	30.42
Delays, per cent.		
Repairs	10.97	5.70
Electrical	3.17	1.85
Waiting for barges	24.21	26.35
Moving barges	2.09
Other delays	12.22	6.32
Total delays, %	50.57	42.31
Total time worked, %	49.43	57.69

Besides the cableways from two to five boom derricks were operated unloading stone and sand. The performance of these derricks for the two years ending June 30, 1912, was:

	1910-11.		1911-12.	
	Hr.	Pct.	Hr.	Pct.
Time delayed	11,694	50.92	3,677	48.73
Time working	11,274	49.08	3,869	51.27
Time in operation	22,968	100.00	7,546	100.00

Pacific Locks. Crushed stone for the concrete work at Pedro Miguel and at Miraflores was obtained from one quarry opened in the west face of Ancon Hill. The rock was drilled and blasted and loaded into cars by steam shovel. The cars ran from the quarry face by a series of switch-back tracks to the crusher house and onto the crusher floor. The crusher plant was a side hill plant and consisted of a No. 12 gyratory crusher feeding to four No. 6 gyratory crushers. The crushed stone was conveyed by horizontal belt conveyor to storage bins mounted on trestles over railway tracks. Cars loaded from the bins were hauled in trains to Pedro Miguel and Miraflores and the stone was dumped from trestles into storage piles parallel to the locks and close enough to be within reach of the berm cranes.

Operations at Ancon quarry began Feb. 10, 1910; detail opera-

tions are available from this date to July 1, 1912. For the year ending June 30, 1913, the output of crushed stone was 688,301 cu. yd., which cost in storage piles at the locks 77.95 ct. per cu. yd. The cubic yard cost for quarrying, crushing and transporting stone for the Pacific locks to July 1, 1912 was:

	1909-10.	1910-11.	1911-12.
Quarrying in cu. yd.	175,174	855,824	839,279
Stripping	\$0.1736	\$0.0476	\$0.0423
Drilling1388	.0449	.0552
Blasting0927	.0421	.0465
Loading0689	.0452	.0356
Transportation1402	.1727	.0576
Tracks1741	.0243	.0379
Maint. equipment0855	.0333	.0568
Plant arbitrary2300	.2447	.1903
Total per cu. yd.	\$1.1038	\$0.6548	\$0.5222
Crushing:			
Crusher operation	\$0.0346	\$0.0172	\$0.0179
Bins and conveyors0089	.0045	.0045
Power0528	.0183	.0187
Maint. equipment0033	.0175	.0311
Plant arbitrary0649	.0762	.0592
Total per cu. yd.	\$0.1645	\$0.1337	\$0.1314
Transportation:			
Train operation	\$0.0728	\$0.0447	\$0.0366
Track0209	.0075	.0004
Dumping0138	.0098	.0110
Maint. equipment0310	.0157	.0206
Plant arbitrary0500	.0553	.0590
Total transportation per cu. yd.	\$0.1885	\$0.1330	\$0.1276
Division expense0455	.0228	.0184
Grand total per cu. yd.	\$1.5023	\$0.9443	\$0.7996

Besides furnishing stone for the lock concrete, the Ancon quarries shipped crushed stone to other divisions and for municipal work. The performance of the Ancon crushers for 1910-11 and 1911-12 was:

	1910-11.	1911-12.
Yardage crushed	855,824	937,908
Delays, per cent:		
Repairs	5.11	6.43
Crusher choked	4.67	2.80
Waiting for stone	3.15	10.55
Waiting for trains	3.38	3.79
Other delays	9.49	4.52
Total delays, per cent.	25.80	28.09
Time working	74.20	71.91
Time under pay	100.00	100.00

Subaqueous Rock Excavation, Panama Canal. For data on this see Chapter XVIII.

Ditch Excavation, with Steam and Electric Shovels, Los Angeles Aqueduct. (Western Engineering, Feb., 1913.) The

following steam shovel cost data and operating records are given by Mr. D. W. Peterson, Engineer, Olancho Division, Los Angeles Aqueduct, whom I quote in full. The aqueduct on this division is open concrete lined canal of the general cross-section shown by Fig. 162. The construction quantities per lineal foot nominal section are 10.57 cu. yd. of excavation and 0.81 cu. yd. of concrete.

The materials excavated may be divided into four classes as follows: (1) Loose desert soil, a sandy loam; (2) boulders of medium size (up to 5 ft. diameter) more or less cemented; (3) extremely large boulders, loose or cemented; (4) cemented gravel or solid rock. All these classifications are encountered separately and in combination and either in level cutting or on the steep slopes. The yardage per foot ranges from $8\frac{1}{2}$ cu. yd. minimum to as high as 30 cu. yd. on the sidehill.

Long-boom power shovels are used to excavate the ditch. Two of these are model 60 Marion steamers of standard gage with 35-ft. booms and $1\frac{1}{2}$ -cu. yd. dipper. A third is of the same type with 38-ft. boom and the fourth is a special model 60 Marion electric with 40-ft. boom and $1\frac{1}{2}$ -cu. yd. dipper. The steamers have special bank jacks designed for the small space allowed in a ditch with a 12-ft. bottom and with 1 to 1 side slopes. These jacks are operated by hand. The electric shovel has an 8-ft. gage, high A-frame, and telescoping bank jacks operated by separate 10-hp. motors mounted over the jacks. This shovel is operated by a 2,200-volt 100-hp. motor. The dipper handle is operated by a friction clutch.

Each of the two shifts on the steam shovels requires the following crew:

1 operator, per month	\$155.00
1 craneman, per month	115.00
1 fireman, per month	80.00
4 pitmen, per day	2.50
4 pitmen, per day	2.25

These men work six days of 8 hr. each per week and repair the shovel on Sunday. All meals are furnished by a mess contractor to the men at 30 ct. each. The total cost for labor is \$955 per month a shift, or \$1,910 for two shifts. A night watchman on the shovel at \$75 per month brings the total labor cost to \$1,985 per month for two shifts.

During the first year, freight on fuel oil was \$11.76 per ton or \$1.96 per barrel of 42 gal. This was later reduced to \$8.52 per ton or \$1.42 per barrel. The average price of fuel oil in the vicinity of Bakersfield has been 45 ct. per barrel, and so the average cost delivered to the shovels has been about \$2.25 per barrel. Each shift uses 10 bbl., a total of 20 bbl. per day. With an average of 48 shifts worked in one month the total oil con-

sumption is 480 bbl., which at \$2.25 per barrel amounts to \$1,080. Repairs of various kinds amount to \$175 per month. Other small charges for lights, various small items, etc., bring the total costs to \$3,500 per month.

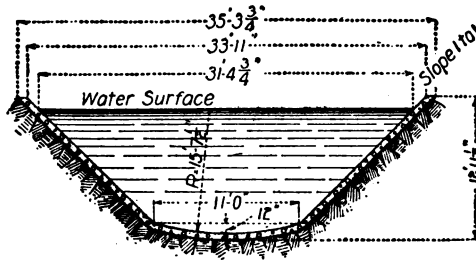

Fig. 162. Typical Section of Open Canal.

In the second class of work in boulders up to about 5 ft. diameter, more or less cemented with a hard indurated clay or gravel, the steam shovels with little or no shooting ahead except to bulldoze some of the larger boulders, obtain 2,600 ft. progress per month with about 22,000 cu. yd. output. Due to the powder used, and the increased repairs, the cost for the month for two shifts is:

Labor	\$2,000
Fuel oil	1,000
Repairs	350
Powder	400
Miscellaneous	200
Total per month	\$3,950

This is an average of 18 ct. per cu. yd., exclusive of interest, depreciation and general expense.

The electric shovel cannot dig such material without having it shot up in advance at a cost of 11.4 ct. per cu. yd. Holes are put down 12 to 15 ft. apart and about 2 ft. below grade, and are shot with about 110 lb. of black powder; 1,600 ft. of progress with 14,000 cu. yd. output is an average month's work. Delays and breakdowns become more serious and frequent. It has been found better to plug a shallow hole in boulders ahead of this shovel rather than bulldoze them, as the shovel suffers too much from heavy shooting. With an electric shovel the monthly costs are:

Labor	\$1,700
Power	130
Repairs	250
Powder	100
Miscellaneous	200
Total per month	\$2,380

Add to this \$1,600 for drilling ahead of the shovel and the total excavation cost is \$3,980, with an average of 28 ct. per cu. yd. exclusive of interest, depreciation and general expense. This is 10 ct. per yard more than it costs with the steam shovel. Here especially the smaller progress of the electric shovel seriously affects the cost of trimming and concreting the ditch.

No attempt is made to use the electric shovel in the more difficult classes of work. In the heaviest boulders, in level cutting, it is very difficult to make more than an average of 1,800 lin. ft. per month with the steamers on a two-shift basis. At places, granite boulders 10 to 20 and even 30 ft. in diameter are encountered in large numbers. A 3-in. Sullivan drill, operated by steam from the shovel, is used in the pit to put holes in these boulders. Of course, all boulders possible are bulldozed with large quantities of dynamite. Labor costs are higher, as two drill men and a tool sharpener are added to the usual crew. There is not much fuel oil used, for the reason that sometimes the shovel can dig only an hour or two per shift. The total monthly expenses are:

Labor	\$2,300
Fuel oil	850
Repairs	450
Powder	1,000
Miscellaneous	200
Total per month	<u>\$4,800</u>

The unit cost for 15,000 cu. yd. is 32 ct. per cu. yd., exclusive of interest, depreciation and general expense.

The next condition, and this by far the most difficult class of material to excavate, is where enormous boulders are massed into fairly solid formation on a steep sidehill with cuts of 50 to 70 ft. on the upper side. There are layers of cemented gravel in with the boulders, with enough loose material at places to cause the drill holes to ravel badly. Machine drills could not be used, for the reason that the holes ravel too much and the drill would constantly stick. Two rows of deep holes have to be put down, one along the inside edge of the bottom of the ditch, about 4 ft. below grade and the second about half way up the slope. The former holes are 24 ft. in depth, the latter about 16 to 18 ft. Two or three days are required by three men to drill, or churn down each hole. The deep holes are then sprung to hold about 450 lb. of 5% Judson powder and the shallow ones to hold from 250 to 300 lbs. As each of these sets of holes loosens about 350 cu. yd. of material, the cost amounts to about 25 ct. per cu. yd.

It was realized that a shovel with a 35-ft. boom which could reach up only 22 ft. and out from 25 to 30 ft. could not handle a 70-ft. cut on the upper slope. Some work up to 50 ft. was

done with one shovel, but it was extremely slow, as the top 20 ft. had to be barred down to the shovel. A model 40 Marion steamer, which was available, was put in ahead of the ditch shovel to handle the top cut. The shovel had a boom 25 ft. long, standard jacks, and a $\frac{3}{4}$ -cu.-yd. dipper. It was planned to take down about 40 ft. of cut with this, leaving 20 to 30 ft. for the shovel in the ditch. It was soon found that this shovel was a benefit, but not nearly as much as a standard model 60 shovel would be. However, it was used to finish up the heavy cutting through the boulders. About 1000 ft. progress with 27,000 cu. yd. output was obtained by the two shovels through the heaviest boulders. The advance drilling had to be done extremely well, but an enormous amount of bulldozing was required to break up the individual boulders. Repairs naturally were very heavy. Advance drilling and shooting costs 25 ct. per cu. yd. or \$6.75 per lin. ft. of aqueduct. The monthly cost for operating the two shovels was:

Labor	\$3,600
Fuel oil	1,300
Powder	1,000
Repairs	600
Miscellaneous	300
	<hr/>
Total per month	\$6,800

The unit cost for excavation was 25 ct. per cu. yd. or \$6.80 per lin. ft., making a total for all drilling, shooting and excavation of \$13.55 per lin. ft., or 50 ct. per cu. yd. This extreme condition did not prevail over more than a few thousand feet. In fact, the highest cost on a single mile was \$9.25 per lin. ft., or 45 ct. per cu. yd. for excavation, exclusive of interest, depreciation and general expense.

For the first six miles in the Alabama hills, the ditch to a considerable extent is built in a formation which ranges from a solid rock cut to one which has soil, boulders, cemented gravel and broken angular rock, separately or with the last two mentioned in combination, overlying but a foot or two of solid rock. The rock of the Alabama hills is an extremely hard andesite. Pits are dug from 12 to 100 ft. apart to prospect thoroughly ahead of the shovel, and except where there is only a foot or two of solid rock above sub-grade, drilling and shooting is done to break it up. In normal cutting, this can be done very easily with ordinary methods. In some of the work on the sidehill, with a rock cut 50 ft. deep on the upper slope, one shovel excavated the section. The line had been drilled in advance with a double row of holes and shot heavily.

Prospecting, drilling and shooting costs 25 ct. to 40 ct. per cu. yd. of solid rock. The excavation costs 18 cts. to 30 ct. per cu. yd., depending on how well the shooting had been done and how

much delay there was in sloping down the portion of the hill-side the shovel could not reach. In rock work, every effort has been made thoroughly to shoot up the section in advance of the shovel, and this should extend to such a depth that the bottom and toe of the slopes are entirely broken. Too light shooting also makes the rock seamy and is far worse than a waste of money.

As explained previously the two-shovel plan, Fig. 163, on heavy sidehill cutting should be used. But to get the best results the top shovel must be of ample capacity and so, although but a few

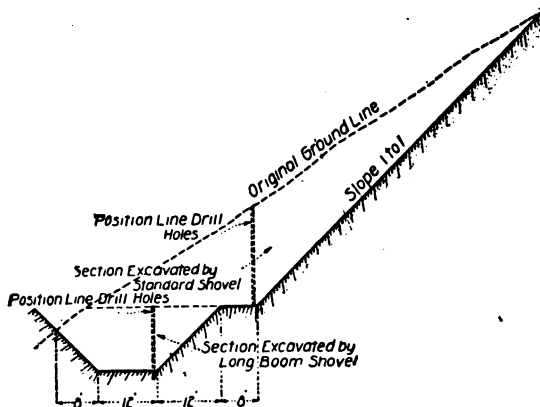

Fig. 163. Two Shovel Method.

months' work remained, a model 60 Marion steamer with 25-ft. boom and $2\frac{1}{2}$ -cu.-yd. dipper was purchased. It was pointed out that this shovel would do fully four times as much work as the long boom model 40 with the $\frac{3}{4}$ -cu.-yd. dipper and at the same daily cost. While the small shovel used only 7 bbl. of fuel oil per shift the repairs for it in heavy work were so much greater than on a large shovel that it cost just as much as the larger model to operate. A dipper handle 2 ft. longer than the standard was placed on the new shovel to give it a greater working range. This shovel takes down a bench about 40 ft. high on the upper side, with some aid of the pit crew sloping at the top, leaving only a level cut of 12 ft. for the ditch shovel; besides, it leaves a 6-ft. berm between the ditch and the hill slope. There is, of course, a great deal of difference between excavating a sidehill bench cut with a standard-boom shovel and digging a ditch with a long-boom shovel. In the first case, only enough lift of the dipper is required to fill it and then it is swung

quickly to dump. In the second case, the dipper usually has to be raised from 18 to 20 ft. each time, then swung slowly out and back with time to lower again into the pit. Not only is the long-boom shovel much slower in action, but the dipper used is only about one-half the capacity of that on the standard shovel. An actual test shows the 35-ft. boom shovel with $1\frac{1}{2}$ -cu.-yd. dipper when digging broken rock takes out $2\frac{3}{4}$ buckets per min. or 4.1 cu. yd. per min. The 25-ft. boom (standard) shovel with $2\frac{1}{2}$ -cu.-yd. dipper takes out 4 dippers per min.—10 cu. yd. Thus during time actually spent in digging, the output of the standard shovel is 2.4 times as great as the long-boom shovel in the ditch.

Behind the first shovel, there follows the prospecting and drilling gang to find and shoot all solid rock that could not be handled economically before the standard shovel had passed. Test pits are put down about 25 ft. apart to discover any ledge of solid rock, and, when any is found it is more thoroughly prospected and shot. When but 1 or 2 ft. of rock stands above sub-grade no effort is made to work through 10 ft. of loose covering to drill it, but it is left to be drilled and shot in the pit after the ditch shovel has stripped the covering. A long-boom shovel can strip about 14 ft. ahead. This section is then drilled by machine and shot. In cemented gravel, the drilling is much easier. This formation does not require as heavy shooting, and when found in the base of the pit or up in the face, it can often be "bulldozed." But as far as possible nothing solid is left for the ditch shovel.

Owing to the extreme variation in the proportion of loose to solid rock it is difficult, in the absence of measured yardage of each separately, to give more than an estimate of the segregated costs. Prospecting for solid rock can be more conveniently and thoroughly done when the section is handled in two cuts and the drilling itself can likewise be done to better advantage and at less cost. Drilling and shooting is done for 25 ct. to 35 ct. per cu. yd., including prospecting for the rock. Excavation costs 6 ct. per cu. yd. for the standard shovel on the bench and about 22 ct. for the long-boom shovel in the ditch. This shovel, at best, occasionally is delayed on account of outcrops of ledges just above sub-grade.

To summarize, one shovel in a cut of 22 cu. yd. per lin. ft. with 20% solid rock can make only 800 ft. of progress per month at a cost of about \$5.50 per ft., or 25 ct. per cu. yd., for the shovel in addition to the cost of \$2.50 per ft., 55 ct. per cu. yd., for drilling and shooting all solid rock. With two shovels, fully 2,000 lin. ft. per month progress can be made at a cost of \$2.85 per ft., 13 ct. per cu. yd. for excavation, and \$1.80 per ft., 40 ct.

per cu. yd., for prospecting, drilling, and shooting the solid rock, making a total of \$4.65 per lin. ft. of ditch.

There has not been a great deal of excavation in cemented gravel exclusively, but a considerable amount of drilling and shooting in this formation has already been done. The costs are about 20 ct. per cu. yd. for drilling and shooting such material. It drills faster and does not require as much or as strong powder as solid rock. Excavation of cemented gravel that has been shot up costs about the same as broken stone or about 25% more than earth, depending, of course, on how well the shooting has been done.

When sufficient water under pressure can be obtained conveniently, such materials as earth, broken rock with earth, or cemented gravel thoroughly shot up, can be washed off a hillside sufficiently to make it unnecessary to use a standard shovel to take off the top bench. A hillside is being handled in this manner at the north end of the Alabama hills.

Direct construction costs in the camps only have been considered in the data above given. In addition, such auxiliary charges against excavation as a contractor would have are as follows:

Excavation equipment, per lin. ft. of ditch	\$0.15
Roads, per lin. ft. of ditch	0.01
Water supply, per lin. ft. of ditch	0.04
Administration, including superintendence and housing.	0.10
Other small charges	0.02
Total	\$0.32

This overhead expense of 32 ct. per lin. ft. of ditch for excavation amounts to an average cost of 2½ ct. per cu. yd. for all work, or about 1½ ct. per cu. yd. in easy digging and 3½ ct. in hard digging. This is about 10% of the direct cost.

Table LXXIX gives the unit costs of steam shovel work under different conditions.

TABLE LXXIX. COST OF OPEN DITCH EXCAVATION WITH STEAM SHOVELS

Case	A	B	C	D	E	F
Monthly progress, lin. ft. 4,000	2,600	1,800	1,000	800	2,000	
Monthly yardage, cu. yd. 35,000	22,000	15,000	27,000	17,600	44,000	
Cost per cu. yd.:						
Labor	\$0.060	\$0.091	\$0.1520	\$0.133	\$0.140	\$0.082
Fuel oil or power	0.030	0.0455	0.0570	0.048	0.060	0.035
Repairs	0.005	0.0160	0.0300	0.020	0.020	0.010
Power used in pit		0.0180	0.0670	0.037	0.020	0.005
Miscellaneous	0.005	0.0090	0.0130	0.011	0.010	0.008
Total shovel	\$0.100	\$0.1795	\$0.3190	\$0.249	\$0.250	\$0.140
Prospecting, drilling and shooting, per cu. yd.				0.250	.100*	.070*
Total drilling and excavating	\$0.100	\$0.1795	\$0.3190	\$0.499	\$0.355†	\$0.21†

Equipment	\$0.005	\$0.0080	\$0.0120	\$0.012	\$0.012	\$0.012
Roads		0.0100	0.0100	0.015	0.015	0.015
Water supply	0.003	0.0040	0.0040	0.005	0.005	0.005
Administration	0.005	0.0080	0.0140	0.020	0.025	0.010
Miscellaneous	0.001	0.0010	0.0020	0.003	0.003	0.003
General total	\$0.014	\$0.0310	\$0.0420	\$0.055	\$0.060	\$0.045
Grand total per cu. yd.	0.114	0.2105	0.3610	0.554	0.415	0.255

A, desert soil — sandy loam; B, boulders, 5 ft. diameter, cemented; C, very large boulders; D, very large boulders in solid formation on side hill, top cut 70 ft.; E and F, loose to 20 per cent solid rock, side hill.

* Applies to solid rock portion of section equals 4.4 cu. yds. † Cost of drilling, shooting and excavating section containing 20% solid rock. Solid rock portion would cost approximately \$0.80 and \$0.54 per cu. yd. by the respective methods.

In every case except D and F, a model 60 Marion shovel, with a 35 to 38-ft. boom and a 1.5 cu. yd. dipper, was used. In case D the 1.5 cu. yd. shovel was assisted by a 0.75 cu. yd. steam shovel with a 25-ft. boom (model 60) which worked on the top cut. In case E the 1.5 cu. yd. shovel was assisted by a 2.5 cu. yd. shovel with a 25-ft. boom (model 60).

Some Records of Channeling, Drilling and Cableway Work. (*Engineering and Contracting*, July 8, 1908.) In the work on the West Neebish channel, in the improvement of the St. Mary's River between Lake Superior and Lake Huron, the excavation was in hard compact Niagara limestone, weighing 4,600 lb. per cu. yd. The total amount of rock excavated was 1,700,000 cu. yd. The depth of the cut varied from zero at the ends to 27 ft. in the center, with an average depth of 15 or 16 ft. The cut was 8,800 ft. long.

In order to make the sides of the cut smooth, channelers were used, there being one Sullivan Class "V" 7-in. channeler, which carried its own boiler, and two 8-in. air channelers, made by the Ingersoll-Rand Co. More than 200,000 sq. ft. of wall were channeled. An average day's run for the machine was from 75 to 100 sq. ft., although on test runs, as much as 205 sq. ft. were cut by one machine. These machines were capable of cutting to a depth of 14 ft., but in most of the work done, the cut was put down in two lifts.

The cut was 300 ft. wide, and in blasting 150 ft. of the breast was shot at one time, allowing the steam shovels to work on one-half the cut, while the drills were at work on the other half. About thirty 3¼-in. percussion drills were used. The holes put down were from 12 to 16 ft. deep. The holes were spaced in 4 x 6 ft., or 5 x 5 ft. squares. This close spacing was found necessary on account of the hardness and dense nature of the rock. The average work done by a drill per shift, both summer and winter, was from 40 to 60 ft., say 50 ft. Air hammer drills were used to drill top holes for breaking up large boulders. The drill holes were shot with dynamite, ¾ lb. (half 60% and

half 40%) being used for each cubic yard of rock blasted.

Four 60-ton steam shovels, mounted on traction wheels with 30-in. tires, were used to load the muck into skips that were handled by four cableways, two having spans 1,100 ft. and two spans of 800 ft. each. The skips were 8 x 8 ft. x 30 in. and held 6 cu. yd. each, but loads as high as 18 tons, consisting of boulders of 7 or 8 cu. yd., were handled by the cableways. The average haul was 300 ft. An aerial dumping device was used on the cableways. One of these cableways handled 30,000 cu. yd. in a month, which was the best month's record for any single cableway. The best month's record for the four cableways was 88,000 cu. yd. of rock, or an average of 22,000 cu. yd. per cableway.

Cost of Excavation by Bridge Conveyor, New York State Barge Canal. (*Engineering and Contracting*, Nov. 30, 1910.)

On Contract 6 the bridge conveyor illustrated in Fig. 164 was used for conveying the excavated material from the canal to the spoil banks on either side. The first cost of the machine was \$105,000 and, as there were about 1,500,000 cu. yd. to be excavated, the first cost of the machine amounted to 7 ct. per cu. yd. Although it proved fairly economical there are other machines of the same general type and of less cost which would have done the work as well and as economically.

The section on which the machine worked was in level country and was 3.5 miles long with 2.5 miles in rock cuts from 12 to 36 ft. deep with an overburden of 2 to 12 ft. of earth.

The machine consists of a two-truss bridge supported on two steel towers, and having cantilever arms extending over the spoil banks on each side. The towers were 90 ft. high and each rested on 32 car wheels traveling on tracks. The arms differ in length in order to provide for wasting earth on one bank and rock on the other, in their estimated proportions. Power was furnished by electric current. A clam-shell bucket that weighed 9 tons and had a nominal capacity of 8 cu. yd. (actual load grasped, 3 cu. yd.) was used to handle the rock.

Two 8-hr. shifts were worked. The highest output for an 8-hr. shift was 438 cu. yd. in limestone and 706 cu. yd. in shale.

The full working crew per 8-hr. shift on the conveyor was as follows:

1 operator at	\$ 6.00
1 electrician at	4.00
1 oiler at	3.25
2 to 5 laborers at	1.50-\$1.60
1 team at	4.00
1 watchman at	2.00
1 bookkeeper, part time	125.00 per month
1 timekeeper	80.00 " "
1 superintendent	250.00 " "

The record of operation for two full years (1908 and 1909)

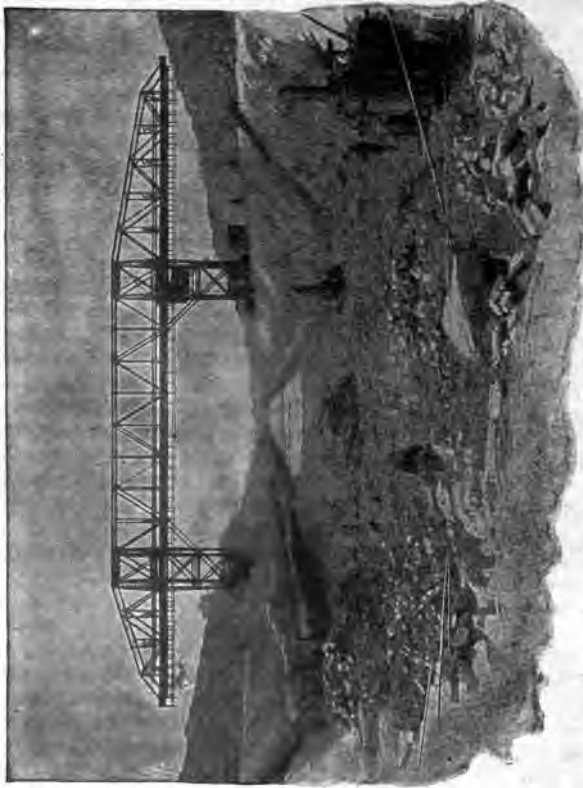

Fig. 104. Bridge Conveyor Excavator, New York State Barge Canal.

is given below. During this time the machine was laid up an aggregate 2 months because of repairs due to a fire and the breaking of the bucket. The total output of the machine was 510,406 cu. yd. of rock and 39,721 cu. yd. of earth or a total of 550,127 cu. yd. This is an average of 22,922 cu. yd. per month. About 30% of the rock was hard shale and 70% was limestone. The cost per cubic yard was as follows:

	Per cu. yd.
Repairs to bridge conveyor	\$0.040
Electric power	0.048
Drilling	0.021
Blasting	0.072
Removal of spoil	0.309
Total	\$0.490

This cost does not include interest or depreciation.

The method of blasting is to drill parallel rows of holes across the prism and break down a working face. The rows of holes are spaced from 20 to 22 ft. apart.

Du Pont 40% dynamite was used.

About 0.5 lb. of dynamite was used per cu. yd. Drill holes were spaced about 21 ft. apart and averaged 12 ft. deep. The speed of drilling was about 6.6 ft. per hr., and the drilling cost was about 20 ct. per ft., exclusive of interest and depreciation.

Cost of Channeling Rock on the New York State Barge Canal. (*Engineering and Contracting*, Nov. 30, 1910.) The following was the cost of channeling on Contract 6, New York State Barge Canal, for 16 consecutive months, Sept., 1908 to Dec., 1909. The rock was limestone. The channelers used were Sullivan Y-8 (8-in. cylinder, 19,300 lb.), costing \$2,800 each. The operating crews was as follows per 8-hr. day:

½ to ⅙ foreman at	\$4.00
1 channeler at	3.50
1 fireman at	2.00
1 helper at	1.75
1 laborer at	1.50

The cost for the 126,544 sq. ft. of channeling was as follows, 58 sq. ft. being averaged per channeler per 8-hr. shift:

	Per sq. ft.
Labor	\$0.217
Coal	0.024
Water	0.002
Repairs	0.001
Interest and depreciation	0.024
Total	\$0.268

There were two shifts worked daily in 80% of the work, two channelers at the start and six at the close of the 16 months' work. The best month's average was 105 sq. ft. per 8-hr. per channeler, and the poorest month was 34 sq. ft. per 8 hr.

Cost of Excavating Lock No. 5 on New York State Barge Canal. Lock No. 5 was about 60 ft. from the bottom foundation to the top of the lock, and about 450 ft. long. Excavation was started December, 1906 and finished July 1, 1907, and was done with a 70-ton Vulcan shovel, equipped with a 2½-cu. yd. dipper. The material handled was Hudson River shale, the top portion of which the shovel handled, without blasting. The material was loaded in 4-cu. yd. dump cars and hauled by dinkeys to the north embankment of Lock 4, an average distance of about 1,200 ft. Through some misunderstanding, the shovel was removed while there still remained about 1½ ft. to be excavated. This was removed later with pick and shovel at a considerable cost.

The cost of the excavation, not including the last 1½ ft. of

depth, is given by Mr. E. J. Becker in *Engineering and Contracting*, Nov. 1, 1911.

The following table shows the labor, coal and dynamite cost of steam shovel work in Lock 5, no allowance being made for depreciation, interest, etc. A total of 28,000 cu. yd. were excavated in 76 shifts:

Drilling	\$0.202
Dynamite	0.037
Shoveling	0.314
Transportation	0.083
Embankment	0.077
Coal	0.041
Total	\$0.754

Cost on embankment includes spreading and compacting. Cost of coal was \$3.10 per ton, and of dynamite \$0.11 per lb. The cost of drilling 19,797 ft. in 72 eight-hour shifts was as follows, per ft. of hole:

	Per ft.
Labor	\$0.197
Coal	0.035
Total	\$0.232

This does not include interest, depreciation and general expense.

CHAPTER XVII

TRENCH WORK

General Considerations. Trenching in rock is a subject upon which practically nothing has been written. In consequence there is probably no class of rock work that is so often mismanaged; and, as a further consequence of the prevailing ignorance, engineers' estimates of cost are often far too low and occasionally as far too high.

In city specifications for sewer trenching in rock it is customary to pay the contractor only for rock excavated within specified "neat lines." If he excavates beyond the "neat lines" he does so at his own expense. In sewer work the most common practice is to specify that payment will be made for a trench 12 in. wider than the outside diameter of the sewer pipe, and 6 in. deeper than the bottom of the pipe when the pipe is laid to grade. A specification should always name a minimum width of trench. Some specifications allow for a side batter of 3 in. to the foot on each side; but unless the trench is to be deeper than can be drilled with one set up of the machine drills, and requires excavation in more than one lift or bench, I see no reason for prescribing a batter to the rock sides. The most rational specification that I have seen for general use in rock trenching is as follows: "All trenches in rock excavation will be estimated 2 ft. wider than the external diameter of the pipe and 6 in. below the sewer grade." Specifications vary so widely as to the "neat lines" that bidding prices for trench work under different engineers are very deceiving to any one who has not studied the particular specifications covering the work upon which the bids were made.

In trenches for city water pipe it is frequently specified that, where rock is encountered, the rock shall be paid for at the contract price per cubic yard *in addition* to the price paid per linear foot in earth excavation.

Different rocks vary greatly in the way the sides and bottom shear off upon blasting. The sides of trenches in soft rocks can be cut off clean when the blast holes are properly loaded; but tough granites, traps, etc., leave jagged walls, generally involving excavation beyond the "neat lines" specified. In excavating thin bedded, horizontally stratified rocks the drill holes

seldom need to go much, if any, below the neat lines; that is, 6 in. below the bottom of the pipe. But in excavating thick bedded and tough limestones and the like, it is generally necessary to drill 12 in. below the bottom of the pipe. In tough granites, traps, etc., it is often necessary to drill at least 18 in. below grade in order to leave no knobs or projections after blasting that would require breaking off with "bull points" and sledges. Obviously the shallower the trench the greater is the importance of making due allowance for this extra drilling. If a trench is only 3 ft. deep and it is necessary to drill 1 ft. below grade, then 33% must be added to the cost of drilling to grade in order to cover the cost of the extra drilling below grade; but if the trench is 10 ft. deep, then only 10% of extra drilling is required. I have known cases where engineers have lowered the grade about 6 in. after a long stretch of rock trench had been completed, and have required the contractors to do this 6-in. skimming at the regular price per cubic yard! As a result, it has cost the contractor several times what he received for the work. In such cases the engineers have generally been ignorant of the actual cost of trench work; for otherwise they doubtless would have allowed an extra price.

Charging the Holes. In tunneling, the explosive is most effective if placed in a pocket at the end of the drill hole. In narrow trench work, on the other hand, the explosive should be distributed all along the hole, leaving only enough length for the least possible amount of tamping. To one who gives the matter thought the reason is obvious, yet I have seen contractors actually "springing" holes in a hard limestone trench, and thus wasting much labor and powder. Contractors often take out deep trenches in several benches, simply because they think it necessary to place all the charge together. As a matter of fact a trench 25 ft. deep, or as deep as the machine will drill, can be taken out in one lift. To do this the explosive is separated into several charges in the hole, tamping being placed between the charges. Where charges are separated in this manner firing should never be done with a fuse, but always with a battery. On page 572 I have described a method of charging alternate sticks of dynamite and wood plugs, the firing of the top stick sending all the others off. In a city this method could probably not be used with safety because of the danger attending such heavy blasting.

In basalt formation at Spokane, Washington, 2-in. holes were drilled at 2.5 ft. apart along the center line of the trench. In 20-ft. holes, 50 lb. of 60% dynamite, and in 14-ft. holes, 25 lb. of the same grade gave good results.

Use of a Blasting Mat. For preventing accidents due to flying

rocks all blasts in cities should be covered either with timbers or with blasting mat (Fig. 165). This should be done to avoid suits for damages, regardless of city ordinances. A blasting mat is readily made by weaving together old hemp ropes, $1\frac{1}{2}$ in. diam. or larger. To make such a mat, support two lengths of 1-in. gas pipe parallel with one another and as many feet apart as the width of the mat. Fasten one end of the rope to one end of the pipe; carry the rope across and loop it over the other pipe; bring it back around the first pipe; and so on until a sufficient number of close parallel strands of the rope have been laid to make a mat as long as desired. Starting with another rope, weave it over and under, like the strands in a cane-seated chair, until a mat of criss-cross ropes is made. Such a mat, weighted down with a few heavy timbers, will effectually prevent small fragments from flying at the time of blasting. The mat and its ballast may be hurled into the air several feet, upon blasting; but it will serve its purpose by stopping the small pieces of rock which are so dangerous even where light blasts are fired. The mat should be laid directly upon the rock. Such a mat will save a great deal of labor involved in laying a grillage of timbers over a trench. It will also make it unnecessary for the blasters to stand far from the blast when firing.

Mats may be made of either wire or manilla rope. Close

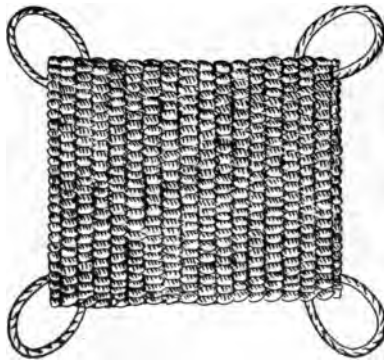

Fig. 165. Blasting Mat.

woven blast mats of $1\frac{1}{4}$ -in. manilla rope with a loop in each corner and binding on sides can be bought in New York for 80 ct. per sq. ft.; mats of 1-in. rope cost 70 ct. per sq. ft.

Cost of Drilling and Blasting. Next to tunneling there is no class of rock excavation requiring so much drilling per cubic yard as does trench excavation. In granites, if shallow holes

are drilled by hand, the holes are frequently spaced not more than $1\frac{1}{2}$ ft. apart. If in a very narrow trench $1\frac{1}{2}$ ft. wide two holes are drilled in a row, one on each side of the trench, and if the rows are $1\frac{1}{2}$ ft. apart, we have two holes drilled in a square $1\frac{1}{2}$ ft. on a side; that is, for every $2\frac{1}{4}$ cu. ft. of rock we must drill 2 ft. of hole, or 24 ft. of drill hole per cu. yd. If the cost of drilling is 25 ct. a ft., we have $24 \times 0.25 = \$6$ per cu. yd. as the cost of drilling alone. It is seldom, however, that such narrow trenching is done. Trenches for small pipes are usually $2\frac{1}{2}$ to 3 ft. wide; two holes are then drilled in a row, and rows are usually about 3 ft. apart. A trench 3 ft. wide with two holes in a row, and rows 3 ft. apart, requires 6 ft. of drilling per cubic yard. With drilling costing 50 ct. per ft., as it often does where hand drills are used in granite, the cost is then \$3 per cu. yd. for drilling alone. Unless the job is too small to pay for installing a plant, hand drilling should never be used in trench work, because the drilling forms such a very large part of the cost.

In a trench 6 ft. wide in hard trap rock three holes were drilled in a row, one close to each side and one in the middle, and the rows were 3 ft. apart, thus requiring $4\frac{1}{2}$ ft. of drill hole per cu. yd. of excavation. The drilling was done with steam drills at a cost of 30 ct. per lin. ft., for the holes were only $4\frac{1}{2}$ ft. deep, the rock was hard, and the men slow, about 35 ft. being the day's work per drill. The contractor had to drill $1\frac{1}{2}$ ft. below grade in this rock to insure having no projecting knobs of rock. While it cost \$1.35 per cu. yd. to drill the $3\frac{1}{2}$ ft. for which payment was made, to this must be added nearly 30%, or \$0.40 per cu. yd. to cover the cost of drilling the extra 1 ft. for which no payment was received, making the total cost of drilling \$1.75 per cu. yd. of pay material. About 2 lb. of 40% dynamite were charged in each hole, making about 2.6 lb. of dynamite per cu. yd. of pay material. The explosives thus added another \$0.40 per cu. yd., making a total of \$2.15 per cu. yd. for drilling and blasting.

In the same trap rock, where the trench was 8 ft. wide and 12 ft. deep, there were three holes in a row and rows were 4 ft. apart, requiring 2.53 ft. + $8\frac{1}{3}\%$ of hole per cu. yd. of pay material to cover the cost of drilling the last 1 ft. of hole below the "neat line." Each drill averaged 45 ft. of hole in 10 hr., and the cost was 23 ct. per ft. of hole; hence, $2.74 \times 0.23 = \$0.63$ per cu. yd. was the cost of drilling. About 4 lb. of 40% dynamite was charged in each hole, or 1.1 lb. per cu. yd. of pay material, making the total cost 80 ct. per cu. yd. for drilling and *blasting*. A comparison of this cost of 80 ct. with the \$2.15

above given brings out strikingly the fact that each problem of trench work must be considered in detail by itself.

In a city where the contractor must shoot comparatively small shots in order to avoid accidents to buildings and suits for damages arising from "disturbing the peace," it is seldom possible to space the holes more than 3 or at most 4 ft. apart. In trenching in soft sandstone in Newark, N. J., where the trench was 14 ft. wide and 10 ft. deep, there were five holes in a row (the distance between holes being $3\frac{1}{2}$ ft.) and rows were 4 ft. apart, making 2.4 ft. of hole per cu. yd. Each hole was charged with 4.12 lb. of 40% dynamite, making practically 1 lb. per cu. yd. About half the dynamite is charged at the bottom of each hole, then tamping is put in, and the other half is charged up to about $2\frac{1}{2}$ ft. below the mouth of the hole. Each steam drill averaged 90 ft. of hole per 10 hr., making the cost of drilling 10 ct. per ft. of hole, or 24 ct. per cu. yd. Including the cost of dynamite and the placing of timbers over each blast, the cost of drilling and blasting was 40 ct. per cu. yd. This is probably as low a cost for breaking rock in trenching as can be counted upon under favorable conditions. In this rock there was no necessity of drilling below grade.

I am indebted to Mr. F. J. Winslow for the following data on trench work in Boston, Mass. House sewer trenches are never less than 3 ft. wide, and trenches for water pipe (16 in. or less) are $2\frac{1}{2}$ ft. wide. The rock is granite, and the drill holes are usually 3 ft. apart. On small jobs hammer drills are used, one man holding and two striking. For a hole 10 ft. deep the starting bit is $2\frac{1}{2}$ in. and the finishing bit is $1\frac{1}{4}$ in. diam. A drilling gang of three men averages 8 to 10 ft. of hole in 10 hr., although in soft rock 20 ft. may be drilled in 10 hr. Force-ite containing 75% nitroglycerin is commonly used, $\frac{1}{2}$ to 3 sticks being charged in a hole. Force account records for granite trenching show that the average cost during the years 1890 to 1905 was \$3.80 per cu. yd., including excavating and piling up the rock alongside the trench.

I am indebted to the Harrison Construction Co., of Newark, N. J., for the following information: In a sandstone trench about 6 ft. wide the holes were spaced about 3 ft. apart, thus requiring $4\frac{1}{2}$ ft. of hole per cu. yd. In seamy rock, shallow holes 4 to 6 ft. deep were drilled, and from 2 to 3 sticks of 50% dynamite were charged, each stick being $1\frac{1}{2}$ x 8 in. This is equivalent to 0.55 lb. per cu. yd. Where the rock was solid, the holes were drilled 8 to 10 ft. deep and the dynamite charge doubled.

Removing Rock from Trenches. The cost of throwing rock

out of shallow trenches or of loading it into buckets to be raised by the engine of a derrick, a locomotive crane or a cableway, is somewhat greater than the cost of handling rock in open cuts. A fair day's work for one man is 6 cu. yd. of solid rock loaded, when there is little sledging; but the output may be only 4 cu. yd. where there is a large amount of sledging to be done.

If cableways or derricks are used for hoisting the rock, bear in mind that they will be idle most of the time, for the drilling limits the output. With a given number of drills to a cableway, estimate the number of cubic yards of rock that the drills will break per day and divide this yardage into the daily cost of operating the derrick. Thus, in a trench 6 ft. wide, if the holes are 3 ft. apart, each cubic yard of rock requires $4\frac{1}{2}$ ft. of hole, and each drill will break 13.3 cu. yd. per day where 60 ft. of hole is a day's work. With four drills per cableway the daily output is $4 \times 13.3 = 53$ cu. yd. The cableway would be capable of handling several times this output were it not limited by the drilling. Notwithstanding that all this seems self evident, I have known more than one contractor to overlook the fact that the cost of handling rock from trenches is very much greater than in open cuts where holes are farther apart and where a few drills can keep a cableway busy. In my book on "Earth Excavation" I have given in detail the cost of operating a cableway on trench work, and elsewhere in this book will be found the cost of hoisting with derricks.

Comparative Cost of Hand, Steam and Air Drilling in Boston.

Actual costs of work in water pipe trenches in Boston are given by Mr. Frederick I. Winslow in *Compressed Air Magazine* (also *Engineering and Contracting*, Feb. 18, 1914). The following costs are based on one-drill plants, although more than one drill may be operated:

	Hand	Steam	Air
No. of ft. drilled per 8-hr.	8-12	50-70	80-120
Cost of hand and machines per 8-hr.	\$7.00	\$12.00	\$16.00
Cost per ft. of hole drilled	0.87	0.24	0.20
Cost per cu. yd. of excavation	3.50	0.96	0.80

This is based on 4 ft. of drill hole per cu. yd.

Cost of a Sewer Excavated with Hand Drills. The comparative cost of hand and machine drilling in trenches is discussed fully in Chapter II. The examples presented seemed to show that hand drilling was advantageous in sticky, fitchering rock, and machine drilling in hard rock.

In a trench $2\frac{1}{2}$ ft. wide and $5\frac{3}{4}$ ft. deep, the rock, a bastard granite, was found in the bottom of an average depth of $2\frac{3}{4}$ ft. The drilling was done by hand using $1\frac{1}{4}$ -in. drills, 1 man holding and 2 men striking with 8-lb. hammers. A total of 96 ft. of hole was drilled or 3.2 ft. per cu. yd. of rock. The

time required was 3.1 man hours per ft. of hole. The time work of excavating 35 cu. yd. was:

	Per cu. yd.
Drilling, man-hrs.	\$ 9.92
Mucking, man-hrs.	3.43
Total	\$13.35

A batch of 120 drills were sharpened, or 4 per cu. yd., or 1 per 0.75 ft. of hole drilled. The amount of explosive used per ft. of hole was $\frac{1}{2}$ lb. Labor does not include backfilling. The above data are furnished by Edward B. Roberts, Engineer-Contractor, Boston, Mass.

Portable Gasoline Air Compressors and Hammer Drills in Trench Work. The prices of several types of portable compressors using gasoline for fuel are given in Chapter VI. This outfit is used in connection with small pneumatic drills of the hand hammer type, which are particularly suited to trench excavation in cities. These outfits can be used wherever a wagon can be hauled and may be moved frequently at low cost as the work progresses. Some costs of work with this type of equipment are given in the Sullivan Company bulletin as follows:

One New England city, which bought an outfit last spring, has used it for several months in cutting trenches for water pipes. The rock consists of granite ledges and boulders. The average footage, with one large and one small hammer drill, is about 160 ft. of hole in 9 hr. The compressor uses about 15 gallons of gasoline per day. The superintendent of the water works department estimates that there is a saving of from 65 to 75% in removing rock in trench work with this outfit, as compared with hand drilling.

"D B-15" drills have been used very successfully in narrow sewer cuts at Louisville, Ky., and Bloomington, Ind. At the latter point, forty 18-in. holes per drill per shift was the average performance of 12 drills for several months' work. The best record was 100 holes, or 150 ft. of drilling, in a 10 hr. shift, while thirty-six $3\frac{1}{2}$ ft. holes were drilled by one tool in 7 hr. The oölitic limestone was of varying hardness, very irregular, full of mud pockets, and often covered with water.

Records kept a year or two ago, on the classes of work described above, by the street department at Gloucester, Mass., show that the hammer drills, driven by a portable compressor, did about three times as much work as the tripod drills formerly accomplished. The cost of operation for the drills and compressor was about one-third less than that of the steam drills

and boilers. Some of the performance records of the hammer drills are worthy of note. In 16 hr., the "D B-15" drill put in 47 ft. in 25 holes, ranging from 19 to 36 in. deep, and the "D B-19" drilled 19 ft. or five holes running from 32 to 60 in. in depth.

This included loading, shooting, and all details, and, further, the drills were not operated at the same time. Holes 5 ft. deep were drilled frequently in 30 min., and the best time noted for a hole of this depth was 20 min. This drilling was done in very hard dark green bastard granite.

Air Hammer Drills in Small Sewer Trenches. Mr. Geo. S. Thou gives the following information relative to the cost of rock excavation in sewers. The material through which the trenches were excavated was earth and Bedford limestone. The stone in many cases outcropped to the surface. Where it was covered with soil it was generally very uneven. Sometimes there was a series of "hog backs," extending across the trench, which was from 2 to 8 ft. wide outcropping or almost outcropping at the surface. Between these were seams of clay sometimes extending below the grade (bottom) of the sewer. The average depth of sewers was about 6.5 ft. The depth of the rock varied from a few inches to 12 ft.

Where the rock was fairly uniform in depth and the surface level, holes were placed on each side of the trench 19 in. apart along the trench. A hole was placed in the center of trench halfway between every alternate pair of side holes. Where the depth of rock was less than 1 ft. no side holes were driven. In some cases the center holes were omitted and the side holes were placed 1 ft. apart. This arrangement gave good results in blasting. All holes were drilled 6 to 8 in. below grade. When the depth of the rock exceeded 4 ft., holes 4 ft. long were drilled and shot, and the rock redrilled.

The outfit and its approximate cost was as follows:

One 10 x 12-in., single stage, belt driven air compressor, rated at 140 cu. ft. of free air per min. at 100 lb. pressure at 150 r.p.m., with 1,000 ft. of 1½-in. pipe, valves, etc., air drum, 7 x 9 ft. tool house, etc., cost \$800. This compressor was mounted on skids and drawn and operated by a 16-hp. traction engine rented at a cost of \$5 per day including the wages of an engine-man. Fuel and oil were furnished by the contractor.

One 8 x 9 x 12-in., single stage, steam-driven air compressor, rated at 124 cu. ft. of free air per min. at 100 lb. pressure at 150 r.p.m., with 1,000 ft. of pipe, etc., air drum, tool house, etc., cost about \$800. This compressor was mounted on four heavy wagon wheels and drawn and operated by a 16 hp. traction engine rented at \$5 per day including the cost of an engineman.

The tool houses were mounted on skids and pulled along by the traction engines.

Air hammer drills weighing about 20 lb. cost \$55 each, and 55 ft. of $\frac{7}{16}$ -in. air hose for each drill cost \$9. The steel bits cost \$2.50 for the 3-ft. lengths and in proportion for the 2 and 4-ft. lengths. The total cost of each outfit was about \$1,300.

Each compressor operated 5 drills at distances as great as 1,200 ft. from the compressor and with the air pressure at 100 lb. at 1,500 ft. When drilling was near the compressor six drills were operated sometimes. The outfit was moved at intervals of about 1,000 ft., the entire outfit being moved by the traction engine at one time.

During the winter it was necessary to re-heat the air, and this was accomplished in two simple ways. The air pipe, between the receiving and the main line, was joined to a $\frac{1}{2}$ -in. pipe 16 ft. long and coiled so that it could be inserted in the cylinder of an ordinary kerosene heater. A better form of heater was made by inserting a piece of 3-in. pipe, 15 in. long, in the pipe supplying the drill. This short enlarged section was kept hot by means of a coal fire in a salamander.

The bits had hollow hexagonal 1-in. shanks, with a $\frac{5}{16}$ -in. hole, and an eight winged rose bit. The gage is $1\frac{1}{4}$ -in. but the bits are allowed to wear to 1-in. before being resharpened. One man operates each drill and the drillers were laborers who had never seen a drill before. They received 2.5 ct. more per hr. than ordinary laborers.

The cost of operating each outfit per 10-hr. day was about as follows:

Rent of traction engine, and engineman	\$5.00
5 drillers, at 17.5 ct. per hr.	8.75
Fuel and oil	3.00
Foreman	3.50
Water boy	0.50
Total	\$20.75

This does not include repairs, interest, depreciation and general expense.

In a dry trench and fairly uniform rock, 5 drillers drilled 263 holes, each 3 ft. deep in 10 hr., or a total of 789 ft., at a cost of 2.75 ct. per ft. of hole. In wet trenches with mud covered rock, the speed was slower. When the bit struck a mud seam in the rock the exhaust generally became choked, and the hole then became filled with dust which caused difficulty in removing the bits when drilling was finished. In some cases it was necessary to leave a bit until broken out by a blast from adjacent holes.

The following table shows the average rate of drilling ~~some~~

holes. None of the observations, except the last gives the time occupied in moving from one hole to another.

Depth of hole drilled In.	Total time per hole Min.	Depth of hole drilled per min. Ft.
16	3	.45
20	3	.55
18	2.5	.60
22	2.5	.78
18	3	.50
24	4	.50
18	2	.75
24	2	1.00
24	3	.66
24	3.5	.57
3 consecutive holes each 4 ft. deep....	15.	.80

The holes were loaded with from 2 to 6 ounces of 60% dynamite, in $\frac{3}{4}$ -in. sticks. From 15 to 20 holes were shot at one time by means of a blasting machine. The blasts were protected by laying a lattice made of 2-in. planks over the trench and a number of wooden poles were piled on the lattice, and all chained together with two log chains.

The average cost of rock excavation (Bedford limestone), including drilling, explosives, and removal of rock from the trench was \$3.40 per cu. yd. In computing the rock yardage the trench was assumed to be 2-ft. wide.

Steam Operated Air Hammer Drill in a Trench. A novel application of steam power in a hand hammer drill, is described by Mr. Charles P. Phelps, in *Compressed Air Magazine* (also *Engineering and Contracting*, Feb., 1914). The wooden handle of the machine remained cool and the exhaust steam was conducted away by a short pipe, thus allowing the operator to remain comfortable. This type of drill is particularly suited to narrow trenches or similar cramped quarters.

The work was at New Britain, Conn. The trench was 42 in. wide, 15 ft. deep, earth 5 ft. and trap rock 10 ft., 3 Ingersoll-Rand jackhammers were used with hollow steel, 3 changes bits, 2 in., $1\frac{3}{4}$ in. and $1\frac{1}{2}$ in., six-point bits in softer rock, cross-point bits in harder rock. Steam pressure was 80 lb. from a portable steam boiler, using 192 gal. of water per day, and 4.5 tons of soft coal in 11 weeks. The labor force consisted of 2 drill runners; 15 to 40 muckers; blacksmith and helper. Wages: drill runners, \$2.50; laborers, \$2.00; blacksmith, \$2.25 per day. The speed of drilling was 50 to 80 ft. for 2 drills per 9-hr. day, averaging 60 ft. for two drills or 30 ft. per drill-day.

Some drilling by hand had previously been done on this work, 15 ft. of hole per day being considered a good average for 6 men. With wages at \$2.00 per day the cost of labor for hand drilling was 80 ct. per ft. of hole.

Drill Carriages for Trench Work. I have already suggested

the use of a quarry bar for drilling holes in trenches where two or more holes are put in across the trench. Some special devices for drilling in trenches are described in *Mine and Quarry* and in *Engineering and Contracting*.

A carriage described by Mr. Chester Mott, was used in the city of Spokane, Washington, and is illustrated by Fig. 166.



Fig. 166. Drill Carriage for Trench Work.

The car was a heavy hand car having corner posts to which were nailed planks, making a box to contain ballast. The car weighed 3,000 lb. and ran upon light rails. The drill, a Sullivan 3 $\frac{5}{8}$ -in. percussive drill, was mounted on the swinging arm by a saddle, in the usual way, while the column was bolted at top and bottom to horizontal beams on the car. Holes were drilled along the center line of the trench, 2.5 ft. apart. In moving from hole to hole, it was necessary to loosen a clamp or dog clamped to the track and push the car to the approximate position of the next hole. The clamp was then secured and the drill aligned accurately by adjusting the drill on the arm of the column.

In constructing the Havana (Cuba) sewers, a carriage illus-



Fig. 167. Portable Boiler and Drill for Trench Work.

trated in Fig. 167 was used. On account of the irregular occurrence of the rock the varying depth of, from 4 to 16 ft., and the different kinds of rock ranging in hardness from very soft to flint-like structure, it was necessary to have drills that would have sufficient capacity to drill to the greatest depth required, and at the same time be sufficiently portable to be easily and quickly moved from place to place. The drills were Sullivan 3¼-in. percussive drills, and they were mounted on a heavy steel bar by means of a column saddle. This bar was set up at the rear end of a wagon truck made up in A-form, of steel channels, mounted on steel wheels. The gage was 6 ft. A 12-hp. boiler was mounted on the truck. The stack was hinged. The entire outfit weighed 5,000 lb. Table LXXX is a time-study of the work of these machines. The column headed "Moving Drills" is the time occupied in moving the machine drills along the bar, or mounting; and the column "Moving Machines" is the time moving the outfit from one point to another on the sewer.

Other Examples from Practice. The following examples of the cost of rock in trenches have been excerpted chiefly from my "Handbook of Cost Data." The use for which the trenches are intended and the kind of pipe laid materially affect the cost. The depth of the overlying earth also determines, in great

TRENCH WORK

717

TABLE LXXX

	No. Holes.	Total Depth, feet.	Average Depth, feet.	Drillings, min.	Changing Steel, min.	Moving Drill, min.	Moving Machine, min.	Total Time, min.
Drill No. 1, total.	6	75.5	12.6	243	179	85	42	549
Av. per ft. . . .				3.2	2.4	1.1	0.6	7.3
Drill No. 2, total.	6	85	14.2	241	155	30	53	479
Av. per ft. . . .				2.8	1.8	0.4	0.6	5.6
Drill No. 3, total.	10	134.5	13.45	404	178	23	33	638
Av. per ft. . . .				3.0	1.3	0.2	0.2	4.7
Drill No. 4, total.	18	71	4	172	86	77	220	555
Av. per ft. . . .				2.4	1.2	1.1	3.1	7.8

measure, the difficulty of removing the rock. For these reasons, I have given all the items of earth excavation, bracing, pipe laying, etc., which make the total cost of the work.

Cost of Rock Excavation for Sewer Trenches in St. Louis.
The following data were published in *Engineering and Contracting*, May 30, 1906: The excavation of sewer trenches in South Benton street, Sewer District No. 6, St. Louis, was mostly in solid rock, of a limestone formation usual to the vicinity. The work was done by contract, and the actual cost of the work is given below.

The rock is a limestone lying in horizontal ledges or strata, 1 ft. to 3 ft. thick. The top 4 ft. or 5 ft. of rock is more or less rotten and seamy, easily shot and sledged to pieces. Below this top rock it is hard and difficult to break up.

Dirt seams run through it all, at times causing the ledge to break out back under the sides of the trench, requiring considerably more excavation than is estimated and paid for under the specifications. An estimate of this extra excavation is about 20% more than is paid for. The specifications stated that when solid rock was encountered in laying pipe sewers, the solid rock was to be excavated 6 in. below the flow line for all pipes of 18 in. or less in diameter, and 9 in. below the flow line for pipes of greater diameter than 18 in. The trench was then to be filled with sufficient earth, well rammed to form a foundation upon which the pipe should be laid. Payment for the work was made as follows: Class "A" (Earth), Class "B" (Loose Rock), Class "C" (Solid Rock), and quicksand excavation for pipe sewers was paid for at the prices bid for Class "A," Class "B," Class "C" and quicksand excavation, respectively, and was estimated for a width 12 in. greater than the inside diameter of the pipe, for all pipe 18 in. or less in diameter and 15 in. for pipes of greater inside diameter than 18 in.

To excavate the top rock, the drill holes were staggered, spaced about 4 ft. apart along the trench and about 6 in. from the sides of the required width of the trench. See Fig. 168. In the lower and harder rock, the spacing of drill holes was 2½ ft. but similarly staggered. If any rock projected too far out, it was sledged or shot off by light shots.

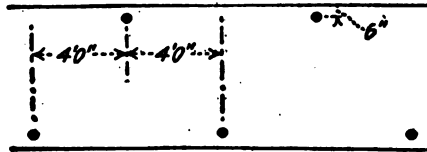

Fig. 168. Spacing Drill Holes.

To break up a ledge or stratum, the drill holes in the top-rock were driven about half way through the ledge while for the lower rock they were driven $\frac{2}{3}$ to $\frac{3}{4}$ the thickness of ledge. Hand drills, 1½-in. bit, were used, one man to a drill, and about 10 ft. of hole was drilled per 8 hr. work. The shots were about one stick of 60% dynamite per foot in depth of drill hole.

The costs given here do not include insurance, collection of special tax bills, tools, and office expenses. The blacksmith bill was \$355, or 20 ct. per cu. yd.; the powder bill \$689.76, for about 4,300 lb. of dynamite. The total amount of rock paid for was 1,683 cu. yd. The cost of dynamite was, therefore, \$0.40 per cu. yd., and amount was 2¼ lb. per cu. yd. On the supposition of 20% more rock actually handled than allowed in the estimates, the dynamite is \$0.34 per cu. yd., or 2 lb. per cu. yd. The average amount of rock for an 8-hr. day per quarryman was 0.96 cu. yd.

The following tables are based upon measurements and quantities estimated and paid for under the specifications. The average costs are derived from this estimate and the expense account on the whole or actual excavation.

370 lin. ft., 21-in. sewer; average depth in solid rock, 14 ft.:	
Foreman, 67 days, at \$5	\$ 335
Quarryman, 700 days, at \$3	2,100
Laborer, 73 days, at \$2	146
Total, 600 cu. yd., at \$4.30	\$2,581
287 lin. ft., 18-in. sewer; average depth in solid rock, 12 ft.:	
Foreman, 54 days, at \$5	\$ 270
Quarryman, 343 days, at \$3	1,029
Laborer, 53 days, at \$2	106
Total, 317 cu. yd. at \$4.43	\$1,405

TRENCH WORK

719

314 lin. ft., 18-in. sewer; average depth in solid rock, 13 ft.	
Foreman, 65 days, at \$5	\$ 320
Quarryman, 350 days, at \$3	1,050
Laborer, 80½ days, at \$2	161
Total 380 cu. yd. at \$4.04	\$1,536
222 lin. ft., 15-in. sewer; average depth in solid rock, 11 ft.:	
Foreman, 36 days, at \$5	\$180
Quarryman, 215 days, at \$3	645
Laborer, 40 days, at \$2	80
Total, 206 cu. yd., at \$4.39	\$905
251 lin. ft., 15-in. sewer; average depth in solid rock, 8 ft.:	
Foreman, 32 days, at \$5	\$160
Quarryman, 129 days, at \$3	387
Laborer, 60 days, at \$2	120
Total, 180 cu. yd., at \$3.70	\$667

The average cost of the rock excavation was as follows:

	Per cu. yd.
Foreman and labor	\$4.20
Dynamite	0.40
Blacksmith	0.20
Total	\$4.80

On the estimate of 20 per cent. more actually excavated than allowed for the average cost of rock excavation was as follows:

	Per cu. yd.
Foreman and labor	\$3.50
Dynamite	0.33
Blacksmith	0.17
Total (actual excavation)	\$4.00

The cost of excavation of earth and loose rock was \$0.50 and \$1.40 per cu. yd. The cost of backfilling was \$0.15 per cu. yd. of excavation.

This information was furnished by Mr. Curtis Hill, Civil Engineer of the Sewer Department, St. Louis, Mo.

Cost of Pipe and Brick Sewers and Manholes in St. Louis. This sewer, which was known as the Tam Avenue public sewer, was constructed in St. Louis, Mo., and consisted of 262.5 ft. of 24-in. pipe sewer and 154 ft. of 22-in. x 33-in. brick sewer and one manhole.

The brick portion of this sewer is under the Missouri Pacific Railroad tracks and the street railway tracks on the adjoining street. The tracks consist of five railroad and two street car tracks. The work here was done in open cut, the railway companies supporting their own tracks. The difficulty of working through and under these tracks somewhat increased the cost of the brick sewer. Even with this, the cost of rock excavation is low, since the rock belonged to a class easily handled, being horizontally stratified limestone, more or less rotten on top, while the rest shattered well when blasted.

The drill holes were vertical (drilled with hand, or churn drills), spaced about 3 ft. along the center of the trench, driven about 2½ ft. deep and loaded with 1½ sticks (about 1 lb.) of 40% dynamite. The driller held his own drill, one man drilling, i.e., only one drill with one man to a hole. Limestone was ordinarily found in one to three foot strata, and the drill holes were driven to such a depth that the shot would tear out the strata. The layers of stone were of a depth at this place that holes about 1½ ft. deep loosened up the stone to the layer beneath. The top 4 or 5 ft. (and sometimes more) of the rock were rotten, and all that was necessary in the way of blasting was to loosen up the ledge, then sledge and pick it out. The drill holes were in the center of the trench, which would leave the sides of the trench ragged, but the rotten rock could be sledged and dressed off to required width.

The trench was 3½ ft. wide. The width of rock excavation paid for is estimated to the extreme width of the sewer brick

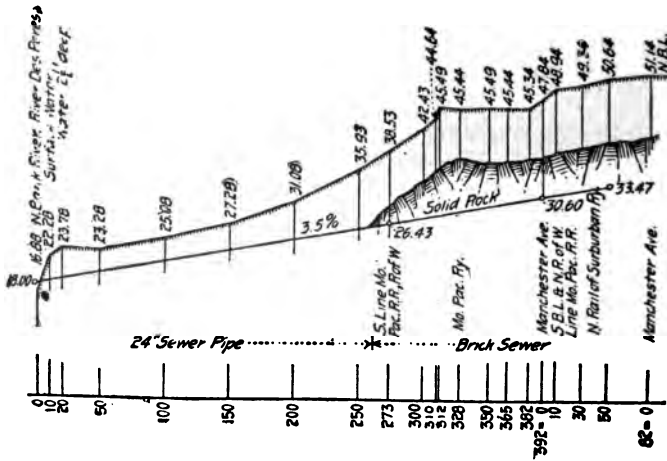

Fig. 169. Profile of Tam Avenue Sewer.

work down to sub-grade. The railroad ballast is included in the earth excavation. All excavation costs include the labor of backfilling, disposal of surplus, bracing, etc., but no allowance is made for lumber for bracing, nor for the incidentals, such as care of tools, insurance, contractor's office expense, etc. No machinery was used.

TRENCH WORK

721

22-In. x 33-In. Brick Sewer. (154 lin. ft.)

	Total.	Per cu. yd.	Per lin. ft.
Earth Excavation (9.2 ft. cut; 190 cu. yd.).			
	Total.	Per cu. yd.	Per lin. ft.
Foreman, 53 hr., at \$0.50	\$ 26.50	\$0.14	\$0.17
Labor, 650 hr., at \$0.25	162.50	0.85	1.05
Total	\$189.00	\$0.99	\$1.22

Solid Rock Excavation (7 ft. cut; 135 cu. yd.).

	Total.	Per cu. yd.	Per lin. ft.
Solid Rock Excavation (7 ft. cut; 135 cu. yd.).			
	Total.	Per cu. yd.	Per lin. ft.
Foreman, 100 hr., at \$0.50	\$ 50.00	\$0.37	\$0.32
Drillers, 570 hr., at \$0.30	171.00	1.26	1.11
Labor, 460 hr., at \$0.25	115.00	0.85	0.75
Dynamite, 70 lb., at \$0.15	10.50	0.08	0.07
Total	\$346.50	\$2.56	\$2.25

Cost of Excavating Granite in Ontario. Mr. E. A. James is authority for the following data: (*Engineering and Contracting*, Apr. 20, 1910.) The excavation was for an 18-in. sewer built at Muskoka, Ont. This sewer had a total length of some 1,300 ft., but only the 550 ft. in rock trench is referred to here. The rock was Laurentian granite and the trench was 9 ft. deep. The excavation was by drilling and blasting, the rock being hoisted by horse derricks and skips and deposited in horse drawn cars operating on track. The haul was some 1,500 ft. for about two-thirds of the spoil and less than 300 ft. for the remainder. The total amount of rock excavation was 1,850 cu. yd., and the itemized cost of excavation was as follows:

Superintending:	Per cu. yd.
Walking boss, at 60 ct. per hr.	\$0.120
Clerk and timekeeper, at 37½ ct. per hr.	0.085
Foreman, at 45 ct. per hr.	0.328
Total for superintending	\$0.533

Labor, Mucking, Loading, Hauling and Dumping:	
Laborers, at 20 ct. per hr.	\$1.555
Teamsters, at 21 ct. per hr.	0.270
Teams, at 40 ct. per hr.	0.545
Cars, at 5 ct. per hr.	0.063
Carts, at 5 ct. per hr.	0.035
Derricks and power, at 15 ct. per hr.	0.095
Handy men, at 27½ ct. per hr.	0.067
Total labor, mucking, etc.	\$2.630

Drilling Rock:	
Drilling at 30 ct. per ft.	\$0.673
Sharpening drills, at 27½ ct. per hr.	0.135
Nippers, at 17½ ct. per hr.	0.206
Coal, at \$10.00 per ton	0.157
Total drilling	\$1.171

Explosives:	
Electric fuses	\$0.052
Caps and fuses	0.013
Batteries, rent	0.020
60% dynamite, at \$10.00 per box	0.551
	<hr/>
Total explosives	\$0.636
Grand total	\$4.970

To the total must be added \$930 for depreciation of plant or 50 ct. per cu. yd., making a total cost of \$5.47 per cu. yd. In studying this cost it must be noted that the trench was narrow, and small shots had to be used, making the amount of drilling large; 1 ft. of hole was drilled per .45 cu. yd. excavated.

CHAPTER XVIII

SUBAQUEOUS ROCK EXCAVATION

Methods Used to Remove Submarine Rock. The removal of rock from its natural position under water involves two operations: (1) The breaking up of the solid rock into pieces of a size that will permit economical handling and (2) the removal of the broken pieces. There are two general methods of breaking up the rock: (1) By means of explosives and (2) by rock breakers or rams, chisels, steam or hydraulic hammers, or drop drills.

By Dynamite Lying on the Rock Surface. This method, which consists in laying charges of explosives upon the face of the rock is neither efficient nor successful in any work except where the rock to be removed is fairly soft and very limited in quantity. The "Austrian Blasting Method"* is a modification of this simple method, and may be briefly described as follows: Small explosive charges are placed on the surface of the rock by means of a blasting apparatus fixed on the rudder of a vessel, the charges being held firmly in position by rods until exploded. Trials held in 1889 on the Jucz Rapids of the Danube gave good results on the first series of shots, but poor results on succeeding series.

By Cofferdams, Caissons or Diving Bells. These methods consist in unwatering the surface of the rock either by building cofferdams or by lowering open caissons and pumping, or by forcing the water from the rock surface by compressed air in closed caissons or diving bells. This method is only adaptable to work small in area or, if large in area, suitably situated. On Section 2 of work known as the Livingstone Improvement of the Detroit River, it was possible economically to unwater a large area by means of cofferdams and to proceed with the work as in rock removal on dry land at a cost of about one-third the cost by drill boats. On page 141 a traction drill used on this work is particularly described. Rock removal by this method at Henderson's Point is described on page 779.

Diving bells or caissons have long been used, and in England the "Sneaton form" of diving bell (a square bottomless box)

* "Method for Destruction of Rocks in Rivers by Means of Blasting Charges Laid Upon Them," by Johanna Laner, Vienna, 1891.

is used for leveling break water foundations and other work of that character. A method first used in Germany, in which the drills were operated from diving bells, is known as the "German Blasting Method." It has the disadvantage that it commands only a small area and cannot be used in strong currents.

When the rock has been unwatered by any of these methods, holes are bored or shafts driven and the rock blown up by explosives.

The Platform Method. This method, sometimes called "The American Blasting Method" was used in the removal of Black Tom Reef (page 776) and on other important work. It is suited to work in rough waters or where the rise and fall of the tide is considerable. Holes are drilled in the rock from a platform supported on spuds and the rock is broken by explosives.

The Drill Boat Method. This is the method commonly used on work of any great extent. The apparatus consists essentially of a float or boat, properly moored or anchored over the rock to be removed, from which the drills are operated.

Drilling. This may be performed by (1) hand hammer or hand jumper drills; (2) drills raised by a rope or similar device and allowed to fall by gravity; (3) machine drills; or (4) diamond drills.

A number of examples of the first three methods are given on subsequent pages. The method of boring with diamond drills, sometimes called "English blasting method," was invented in 1882 by J. T. Jones, and J. H. Wild of England, and is fairly successful where the currents are not strong and where the drill holes are very deep. A method similar in principle was used by the French engineers, Fontan and Tedesco, at the old Panama Canal work.

Rock Breaking by Impact. The Lobnitz system is the most effective and best known of the methods of rock breaking by mechanical means. This rock breaker, which was first described in 1889, is simply a well designed modification of the rock chisel in use on the Mississippi since 1885 (see page 801). A somewhat similar method is that used on the Columbia River, in which hammers actuated by water power act on long chisels from stages built in the river. Tunhard, a Hungarian engineer, devised a method of breaking off the rocks by means of chisels driven by steam hammers.

Rock Removal. This may be effected by hand or by machine, the most common method being by dipper dredges, bucket dredges, or bucket ladder dredges.

The number of technical articles on subaqueous rock excavation is *not as great* as that on other branches of difficult rock work,

such as tunneling or mining, but a greater proportion of the papers contain more detail as to methods and costs than do those on the other branches of rock excavation.

Drills used for Subaqueous Drilling. In paragraphs following these will be found descriptions of submarine work in which nearly every kind of drill is used, from the hand hammer and hand jumper drills through a great variety of devices to the standard drills such as were employed on the Detroit River, at Buffalo, etc.

Standard Subaqueous Drills. Drilling rock under water requires the use of drills of large size and great capacity. The "standard" or "mounting" is usually of a special design made necessary by the peculiarities of the work. The drills are customarily suspended by a cable passing over a sheave secured in the head frame of a gantry or tower and attached to a winch, and by the latter lowered as the drill is fed forward, or raised for changing steels. Sometimes the drills are raised and lowered by a hydraulic feed.

Table LXXXI, page 733, gives the sizes and characteristics of subaqueous drills of several makes.

The Removal of Submarine Rock. The following data are taken from a paper with the above title by Mr. Harold Berridge, M. Inst. C. E., and published in Vol. CLXXIV of the "Proceedings of the Institution of Civil Engineers" of England.

The author speaks of the necessity of careful surveys before and after the work and says greater accuracy is required than for dredging. For the best work the surveying equipment and apparatus will be elaborate.

For progress work he recommends a raft 100 ft. long by 5 or 6 ft. wide constructed of 40 gallon barrels and timber framing; and on this raft a sounding rod 40 to 50 ft. long may be used. Soundings should be taken with the current and the rod carried back to the upstream end as each row is finished. The most satisfactory methods of locating points are by means of transit or sextant angles. Four men and a surveyor can take from 250 to 500 soundings in a day.

Systematic borings should be made in 10 ft. squares for small work and in 100-ft. squares for large work. He recommends a small hoisting engine driving an ordinary drilling apparatus, for this will penetrate all surface material except rock. It is a matter of general experience that borings show lower rock surface than is proved by subsequent investigation to exist; the explanation undoubtedly is that in most rocks fissures, boulders and cracks abound and into the soft material filling the spaces the drill penetrates. A foot or thereabout is generally allowed

and paid for to insure the minimum depth being attained, and if not so allowed for should be included in the contract price. On completion the work should be carefully sounded and also swept by a bar to catch high points.

Surface blasting has been done by putting dynamite into clay or iron pots held firmly against and systematically applied to the surface by iron rods. It has been found by experience that this method is useful in destroying isolated peaks or boulders, but has no appreciable effect on a solid rock surface.

For boring and blasting the general principle followed is to make the spacing of the holes equal to their depth and the weight of the explosive should vary as the cube of the depth. The weight of explosive per yard of homogeneous rock is constant, whether use is made of a large number of small holes or a small number of large holes.

The cost of a blast is roughly about 60% labor, so it would be cheaper to bore a small number of large holes. Practical difficulties in submarine work limit the depths to 4 or 5 ft. in solid rock and this therefore should be the horizontal spacing.

Let L = depth in feet,

C = charge in pounds,

then, for dynamite,

$C = 0.024 L^3$ for hard rock,

$C = 0.014 L^3$ for medium rock,

$C = 0.010 L^3$ for soft rock.

In hard limestone and quartzite Mr. Berridge used for dynamite a coefficient of 0.042, which is close to the coefficient for rack-a-rock used in the granite at Hell Gate, varying from 0.4 to 0.6.

The coefficients for dry blasting in gneiss and granite at Westport, N. Z., are:

0.0835 for blasting powder,

0.0286 for dynamite,

0.0278 for gelignite,

0.0200 for blasting gelatin.

The loss of energy in submarine work arises probably because the charge does not fit closely into the hole, and also extends considerably along the line of least resistance, instead of being concentrated at the bottom of the cone.

Since drilling is so large a part of the cost, it is best to use too much powder than not enough. Moreover, extra disintegration makes the removal of the debris easier—a consideration if the dredge is not specially adapted for rock removal. The higher explosives are generally used and a dynamite having a low percentage of nitro-glycerin is not advisable if it is to be long submerged, as the water washes the glycerin out. Experience shows

that many charges are unexploded and are a source of real danger when the rock is removed, this being a further argument in favor of an explosive not affected by long submersion.

Detonators may be exploded by powder-fuses, or by high or low-tension electricity. Absolute water tightness is of course an essential. Whatever system of ignition is adopted the detonator should be the strongest obtainable; and it is desirable to have a guarantee as to the contents and the percentage of fulminate employed which in the best class is 31 grains of 95 per cent. A weak or defective detonation costing 5 ct. may lose a set of holes it has cost \$50 to drill and charge; and the same effect is produced by a defective fuse.

A powder fuse may be used for small work, but is very slow and its action in deep water so uncertain as to be exasperating. Electric high tension is cheaper than low tension, but is so easily affected by outside electrical currents that many serious accidents have been thus caused, some by such simple causes as escaping steam or air.

Low tension fuses are generally satisfactory if of the highest quality and carefully made on circuits. The circuit may be in parallel with a shorter light Manila lanyard to take the weight of the canister and the pressure of the tide.

Charges of explosive may be conveniently made in zinc canisters of a dimension to go into the hole easily and about 2 in. longer than the charge; the space filled with plaster-of-Paris. Proper means should be provided to carry the explosives without danger from the magazine to the site.

Boring may be carried out by:—(a) Diamond drills; (b) jumper drills; (c) machine drills; any of which may be mounted on barges and worked from the surface of the water; (d) machine drills working in a diving bell or caisson, which may be provided with the means for moving the debris, and also for "leveling up" and other minor work.

The diamond drill is effective but too expensive for common use. The drills are mounted on a barge and are driven by an engine at from 200 to 300 revolutions per minute through a flexible hose fitted with a compensating device. Flexibility is essential to allow for tidal and wave movement and feed of drill. The rods are hollow and flushed with water; and in common with other surface drilling systems are guided and protected by pipes down to the surface of the rock.

The simplest form of jumper drill is that operated by manual labor only. On the Panama Canal in 1888 a raft 82 x 46 ft. was used with 3-in. drill pipes spaced 8 ft. on centers, so the rock could not have been hard. The rods were made of 1¼

in. pipe to reduce weight, and the depth of water required was 20 ft., but no records are in existence to show whether this was obtained.

Several systems have been tried for mechanically lifting these drills. The most satisfactory system has a general arrangement exactly similar to that of an ordinary boring apparatus, the rods are $1\frac{1}{4}$ in. square and 10 ft. long, shorter lengths of 2 to 4 ft. being used in the tidal range, if any. The best form of bit is the circular arc, and the corners especially should be continually dressed sharp to guard against jamming of rods and charges. The drills may be arranged over the side of the barge or in a central well, with 2 to 3 ft. clearance from the side in either case.

The jumpers are lifted and dropped by means of a rope attached to a swivel in the top; this passes over a pulley and down to a drum on a shaft revolved at a constant speed, a single turn being taken round this drum; when the rope is tightened it bites the drum lifting the drill, and when slackened the drill drops. One man works the lifting rope, and another turns the drill on its axis by means of ropes attached to a tiller, fixed just below the swivel.

This apparatus will give 20 to 30 blows a minute and will drill 1 to $1\frac{1}{2}$ ft. of 3-in. hole per hour in hard limestone at a cost varying from 75 ct. to \$1 per foot, each drill requiring about 1-hp. to operate. Jumper drills thus fitted have great flexibility and can be worked in bad weather and in situations where other kinds of drilling would be impossible. The installation cost is low and unskilled labor can be employed, although it must be admitted the operating costs are high.

Machine drills have been largely used of late years and under suitable conditions give great satisfaction. The limiting factor at present is the depth to which they can drill, which depends upon the make. This is said to be about 36 ft. with the H-5 Ingersoll. Beyond this point the weight of the drill rod ($1\frac{7}{16}$ in. octagon) and the friction in the drill hole become too great for the upward lift of the drill piston, even with 100 lb. of steam or air. For steam, flexible metallic tubing is better than rubber, which is soon burnt out.

Specially constructed barges with girder construction longitudinally and across should be used for drilling from. In the United States the sides are 6 in. thick to enable them to fire without moving, 3-in. sides soon leaking badly, so for countries where timber is costly steel barges should be used. When the barges are substantially constructed, individual shots can be fired at once without moving from the site. The barge must

be perfectly steady for drilling, and to obtain this result "spuds" are used, on which part of its weight is thrown.

The machine drill puts down holes in suitable material in an astonishingly short time. Each drill takes from 3 to 4 hp. and the cost for a 3-in. hole varies from 25 ct. to 50 ct. per foot. Sometimes a water jet is employed to wash out the hole previous to charging.

For small installations the drill is fitted on a block working in the slot of a frame, like that of a pile driver; being raised and lowered by a hand winch. Screw feed (hand or automatic) is too slow and is seldom used. Several American installations have hydraulic cylinders for lifting and lowering the drill, a system which gives good results. Drill lubrication should be by supply pipe to obviate stoppages for oiling.

Pipes, similar to those used for jumper drills, are generally provided for drill rods working from the surface. They should have sockets screwed up hard on the upper end of each length, and the top socket should have a "bumping cup" or short nipple, always put on to protect the threads while boring. A light, quick acting winch should be provided for lifting the rods and pipes. Power maneuvering winches and electric light installation soon pay for themselves on barges. The author considers coal and water great nuisances on barges, so expresses a preference for oil engines when they can be employed, because of the advantage in using the fuel, although more difficulties may be experienced in operation.

Diving bells or caissons have been long used and the Smeaton form, a square bottomless box, still survives and is now made up to 14 ft. x 7 x 17 ft., or about 20 tons displacement. It is used in England for leveling breakwater foundations, being hung from Titans and staging in advance of the work; telephones and electric lights are provided and the whole forms a useful accessory to the work, but it is rather insignificant in appearance when compared with the large and elaborate caissons used elsewhere. Other types have been designed to remove as well as to disintegrate the rock debris; but the fact that the two operations are more economically performed by separate apparatus has of late been clearly demonstrated.

The author of the paper then describes several diving bells used on submarine rock removal but the work on which they were used was very extensive in order to justify the expense of such large apparatus.

Rock is frequently disintegrated by mechanical means, the machines being known as rock breakers. This method has been used successfully at Leghorn and at Cotte (in France) since 1867.

At Leghorn, Messrs. Furness & Co. removed a layer of tufaceous rock consisting of thin layers of sandstone sandwiched between two layers of sand. The total depth of water was 30 ft. and the layers of rock ranged from 8 in. to 16 ft. in thickness. The ram was an iron bar 8 in. in diameter and 29 ft. long, having a removable steel point and weighted to about 2.84 tons by means of a cast iron hood. By means of a hoisting engine the drop was regulated so it had a range between 3 ft. and 13 ft., making holes at intervals varying between 1 ft. 6 in. and 3 ft. 4 in., presumably connected with each other by cracking. A total of 140,000 cu. yd. were removed by this method but the system was not successful in removing another layer, ranging from 3 ft. to 6½ ft. in depth.

An interesting machine was designed by the state engineers for work on the Iron Gate of the Danube. The original design was a gang of six steam rams with cross bits, working in caissons and severally weighing from 2 to 3 tons. Each of these was intended to cut down a depth of 1 ft. and the barge carrying the apparatus was meant to move up stream in a straight line, thus cutting off a strip of rock 6 ft. in depth, the operation being repeated in parallel strips. A barge with one caisson and one ram was constructed and had some short trial runs, on the basis of the results it being estimated that the work would cost about \$4.75 per cu. yd. Nothing more was heard of the machine after it was turned over to the contractors.

With the Danube machine the intention was to pound the debris so fine that the current would wash it into the deeper parts of the river bed, since dredging of such a thin layer would be impracticable. A useful machine on the same principle was used at Sydney, N. S. W., for breaking up hard sandstone at the rate of 30 cu. yd. per day and for use in this class of material it would seem the principle is capable of development.

Rock breakers in their present form appear to have been first used on the Rhine, being invented by a Mr. Nobiling. Some were constructed weighing 8.1 tons with a length of 26.2 ft. for use on the Danube. Certain difficulties were encountered due to breakages and the first rams had to be annealed after ten thousand blows; a difficulty subsequently obviated by making the bodies of soft open hearth steel with hardened points. Cast steel rams were made at a later date in Hungary, which would stand 250,000 blows on moderately hard rock. These breakers have also been combined on the same vessel with apparatus for the removal of debris, in the form of grabs and even of bucket dredges, but the combination is only useful for small patches and not for systematic work on large quantities of rock.

The Lobnitz breakers are best known. In 1884, Messrs. Lob-

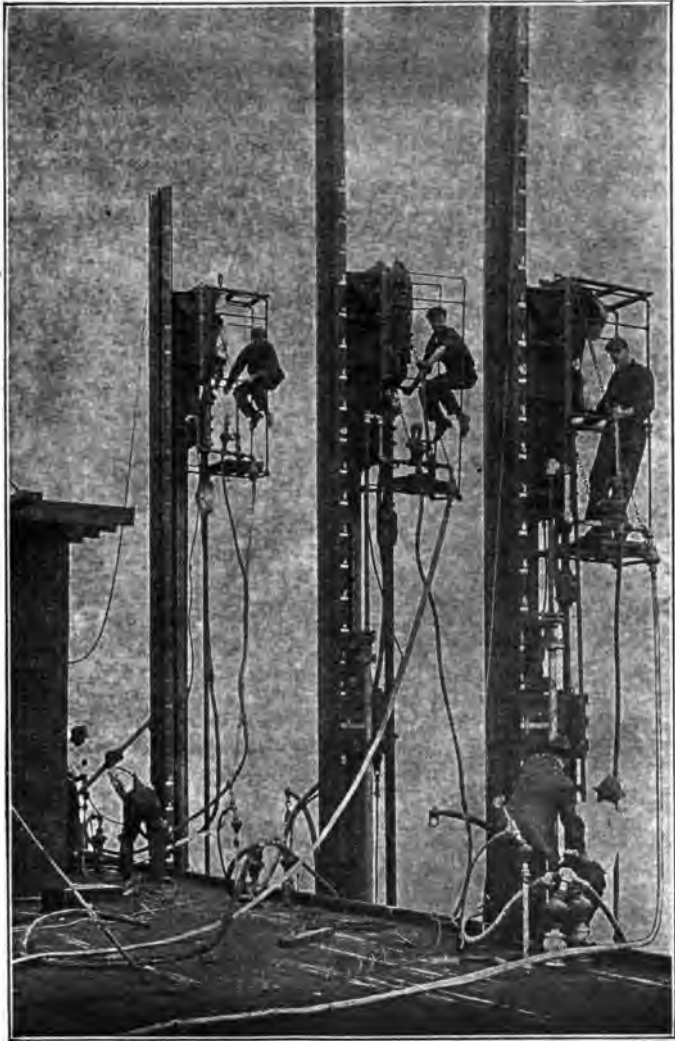

Fig. 170. Corliss Submarine Drills, With 7-in. Cylinders (McKiernan-Terry Drill Co.).

nitz & Co. built for the Suez Canal a dredger equipped with ten 4-ton breakers, but, as elsewhere, the combination of the two functions on one vessel proved unsatisfactory and the rams were afterwards installed on separate pontoons.

The present rams in use on the Suez Canal and at Blyth range from 40 to 50 ft. long by 18 in. in diameter and weigh from 13 to 15 tons. They break up sandstone and shale at these places at an estimated cost of from 26 ct. to 30 ct. per cu. yd. The maximum cost, however, at Suez in hard rock, is about \$1.80 per cu. yd., while the minimum cost in the softer beds is only 4 ct. per cu. yd.

Comparison of Methods; Blasting and Rock Breaking. It is difficult to indicate with precision where the use of either system would be preferable. There is a fairly well marked division in the crushing strength of rocks and it would seem at present that the economical use of the mechanical rock breaker is confined to the weaker kinds, with a crushing strength of 3,000 to 4,000 lb. per sq. in.; that is, up to a point where it can be broken for a cost of about 60 ct. per cu. yd., or where, as at Suez, it takes 10 blows of the breaker to disintegrate 1 cu. yd.

Beyond this point boring and blasting ought to be more economical, and even this depends on the size of the work and cost of installation. The cost of the large rock breaker at Blyth was about \$33,000, equivalent to six or seven drilling barges.

In Mr. Berridge's opinion, boring and blasting may be economically employed in any material that can be drilled. He also believes it is the only method possible where such materials as granite, gneiss, igneous rocks or limestone occur in layers more than 3 ft. thick. Rock breakers on the other hand are proved to work economically in shales, sandstones and similar soft rocks, and in small surface thicknesses of the harder rocks, these being generally softer than the main body. At the Iron Gate depths of 1.64 ft. were allotted to rock breakers and greater thicknesses to boring and blasting.

Other considerations of various kinds arise where work has to be carried on in the confined areas of docks and waterways but their value will depend very much on the exact circumstances in each case.

Spacing of Holes and Amount of Explosive Required. Table LXXXII gives the spacing of holes and the amount of explosives used on a number of pieces of subaqueous work.

Cost of Rock Excavation in the Detroit River. I am indebted to Mr. Chas. Y. Dixon, U. S. Assistant Engineer, for the following data of cost, which were originally compiled by Mr. Harry Hodgman, and which, so far as I know, are the most detailed and complete cost records of subaqueous excavation that

TABLE LXXXI. SUBMARINE DRILLS

Manufacturers.	McKiernan-Terry Co.		Ingersoll-Rand. Sergeant. New Ingersoll.		Sullivan.			
	(a)	(b)	G 1107	H-64	K-64	FS-14	FV-14	FZ-31
Catalog size	5	7	4 1/4	5 1/2	6 1/2	4 1/4	5	7
Diam. of cylinder, in.	5	7	4 1/4	5 1/2	6 1/2	4 1/4	5	7
Length of stroke, in.	8 1/2	10	8	8	9	7 1/2	8 1/2	8 1/2
Depth of hole drilled easily, ft.	30	50	27	40	60	30-40	50	60
Depth drilled without changing bit, ft.	3+	3+	3-6	3-6	3-6	10	10	20
Diam. of holes, in.	1 1/2-2	2 1/4-2 1/2	1 1/4-1 3/4	2 1/2-2	2 1/2-2	2-4	2.5-5	3-6
Size of steel used, in.	15	25	15	18	25	1 1/2-1 3/4	1 3/4-1 1/2	2-2 1/2
Boiler required, hp.	1,800	3,000	420	1,100	1,250	18
Weight, unmounted, lb.
Net price, unmounted	\$325	\$550	\$650	\$400	\$600	\$800

(a) Spool valve. (b) Corliss valve.

TABLE LXXXII. SPACING OF HOLES AND EXPLOSIVE USED

Kind of Rock.	Depth of Hole.		Depth of Hole Below		Size of Hole.	Spacing of Holes.		Grade of Explosive.	Kind of Explosive.	Per. Ft. of Hole.	Explosive Used.		No. of Holes in Round	Location.
	Ft.	Ft.	Ft.	Ft.		Ft. x Ft.	%				Lb.	Lb.		
Hard flinty limestone	5.08	20	2.5	1 1/4-2 1/4	5	5	..	Nitrogl.	8.4	0.74	...	1.3	1	Detroit R. Port Colburne.
Blue limestone, flint	4.9	27	8.0	2 1/2	5	5	60	Dyna.	0.6	0.8	1.8	1.5	1	Detroit R.
Lime boulders	8.2	26	8.0	2 1/2	5	5	60	Dyna.	0.4	1.8	2.9	2.9	1	Detroit R.
Limestone	5.1	26	8.0	2 1/2	5	5	60	Dyna.	1.02	3.08	3.20	3.20	1	Detroit R.
Boulders, limestone, clay	7.6	..	4.4	..	4	5	..	Dyna.	1.26	2.26	3.44	Detroit R.
Bonesone	4.4	25	2.0	..	4	5	Buffalo, N. Y.
Lime boulders, limestone, clay	9.6	7	..	1 1/4-2 1/4	6 1/2	7	50	Gel. Dyn.	0.5 (1)	72	Buffalo, N. Y.
Boulders	6.74	0	..	1 1/4-2 1/4	5	4	75	Gel. Dyn.	0.8 (1)	0.75	0.75	0.75	72	Tusculumla Bar. Tusculumla, N. Y.
Flint	5.95	18	2-4	..	5	4	75	Dyna.	0.52	0.55	1.10	1.10	8	Oswego, N. Y.
Flinty shale sandstone	4.7	..	2	2 1/4-3	Bl. Gel.
Gneiss dyke	9.15	4.7	4.7	45	Dyna.	0.75	0.36	0.36	0.36	1	Briabane Harbor.
Soft shale	9.1	6.6	6.6	45	Dyna.	0.50	0.5	0.5	0.5	1	Ashabula Harbor.
Soft shale	9.5	6.6	6.6	45	Dyna.	0.50	0.5	0.5	0.5	1	Ashabula Harbor.
Soft shale	4.4	19	4.3	3.3	#1	Volatile	1.3-1.8	0.5	0.5	0.5	..	River Yarra.
Clay sandstone	4.5	Powder	1.1	2.0	2.0	2.0	..	Sydney Harbor.
Clay sandstone	3	Dyna.	0.33	0.5	0.5	0.5	..	Sydney Harbor.
Yellow sandstone	6.5-11	11-17	1.5	2%	6.25	6.25	..	Misc.	..	0.85	Blyth Harbor.
Clay boulders	8	12	..	Dyna.	Freemantle Har.
Coralline limestone, sandstone	Gelg.	2.8	2.8

SUBAQUEOUS ROCK EXCAVATION

Rock, clay, gravel, sandstone, etc.	Ft.	Ft.	Ins.	Ft. x Ft.	%	Lb.	Lb. Lb.	30	Location
Mica schist	10.17	...	1 1/2-2 1/4	5	5	1.24	0.11	...	Carr Shosl.
Mica schist	8.13	...	3 1/2-3 1/4	4	4	4.0	4.0	...	Black Tom Reef.
Trap conglomerate	5.35	...	3 1/2-5 1/4	5.1	5.1	...	Way's Reef.
Trap conglomerate	6.30	5	5	4.1	Eagle Harbor.
Trap conglomerate	7.34	7.7	7.7	2.9	Eagle Harbor.
Trap conglomerate	20	8.5	8.5	1.8	Eagle Harbor.
Potsdam sandstone	7.00	26	3	6.0	6.0	1.3	West Neebish.
Potsdam sandstone	6.00	25	2.0	6.0	6.0	0.5	0.54	0.94	St. Mary's R.
Hard, flinty limestone	12.5	...	4 1/2-3 1/4	5.0	5.0	1.63	1.65	2.06	Detroit R.
Hard, flinty limestone	11.0	...	4 1/2-5 1/4	5.0	5.0	3.37	3.53	4.86	Detroit R.
Hard, flinty limestone	14.0	...	4 1/2-less	5.0	5.0	3.37	3.54	4.87	Detroit R.
Hard, flinty limestone	12.1	...	3 1/2-less	5.0	5.0	1.4	1.51	2.05	Detroit R.
Limestone	8.5	...	3 1/2-more	5.0	5.0	1.51	1.63	2.16	Detroit R.
Limestone	7.6	...	4 1/2	5.0	5.0	1.76	2.11	3.20	Detroit R.
Limestone	10.1	5.0	4.5	1.04	1.96	3.02	Detroit R.
Limestone	5.37	...	5 1/4	4.0	4.0	2.00	2.40	3.24	Detroit R.
Limestone	10.75	25	...	6.0	5.0	2.59	4.37	5.87	Detroit R.
Flint	3.5	2.0	...	2.0	3.0	0.12	1.05	1.29	Buffalo, N. Y.
Limestone	9.75	25	...	6.0	5.0	1.22	1.03	1.39	Buffalo, N. Y.
Loose rock, glacial drift, limestone	5.0	25	...	5.0	6.0	1.20	1.07	2.15	St. Mary's R.
Limestone	8.3	13	...	6.0	4.0	1.08	1.21	...	Ahnapee Harbor.
Hard limestone	6.5	...	3.0-	6.0 or less	75	...	1.33	...	Galops Rapids.
Hard limestone	4.66	...	3 1/2	6.0	5.5	2.36	James R.
Hard limestone	4.42	...	3 1/4	6.0	5.0	2.50	James R.
Hard limestone	4.42	...	3 1/4	6.0	5.5	2.47	James R.
Hard formation	10.0	...	3	5.0	6.0	1.2	1.08	1.35	Cienfuegos Har.
Coars. Mica, Schist, Gneiss, Granite	4.0	...	3 1/2	4.0	4.0	6.0	Oak Point.
State, flint	5.0	22.0	...	5.0	4.0	4.0	5.4	21.6	Kennebec R.

have ever been published. In the *Michigan Engineer*, 1903, Mr. Hodgman gave a very complete description of this work upon which he has been continuously engaged since 1895. From Mr. Hodgman's article and from Mr. Dixon's letters to me, I have compiled the following: The work was done under three contracts, as follows: At Ballards Reef, the Buffalo Dredging Co.; at Lime Kiln Crossing, James B. Donnelly, of Buffalo, N. Y.; and at Amherstburg Reach, M. Sullivan, of Detroit, Mich.:

At the mouth of the Detroit River it is usually necessary to drill and blast the material before it may be excavated. The drill boats in use are from 60 to 80 ft. long and from 25 to 30 ft. wide, and are held in position by four spuds, one at each corner. They are equipped with two or more Ingersoll steam drills supported on vertical frames having trucks to permit of the drills being moved horizontally along the edge of the boat. The drills are raised and lowered during the operation of drilling by hydraulic lifts. The boiler furnishes the steam for operating the drills, the pumps used in connection with the hydraulic lifts, the forge, the electric light plant and other machinery with which the ordinary drill boat is equipped. The drill boat usually serves the purpose of a machine shop where repairs are made to the entire dredging plant. It is always conveniently near to all parts of the work, and ordinary repairs are quickly made, the contractor usually providing a great variety of tools and machinery for use in cases of emergency.

The drill boats are usually operated day and night. The holes (about $2\frac{1}{2}$ in. in diam.) are made at the corners of 5-ft. squares to a depth of about 3 ft. below the required depth, at the rate of about 5 ft. per hour per drill. The amount of explosive used is about one pound of 60% dynamite per linear foot of drill hole. The holes are charged by inserting the sticks of dynamite with the exploder and battery wires attached into the bottom of a long pipe, the battery wires leading out through a slit in the side of the pipe. This pipe is lowered into the drilled hole, the dynamite shoved down with a long ram rod, and the pipe withdrawn, a wire spring clamped to the dynamite stick preventing its coming out of the hole. The wires are then attached to the battery and the dynamite exploded. During this operation the drill boat is not moved, nor does the work of operating the other drills cease except at the time of firing. On two occasions, however, the charge of dynamite came out of the hole, and was exploded directly underneath the boat, causing it to sink almost immediately. This may be attributed to carelessness, however, as before exploding the dynamite the battery wires should be drawn up until taut, indicating that it is in place. A quantity of dynamite is always kept conveniently near the work, but no

more than one day's supply is kept at the drill boat, and this is stored in a small scow trailing off the down-stream end of the boat at a safe distance.

The dredges used in excavating the material are of the type known as the dipper dredge. They vary in length from 80 to 135 ft. and in width from 30 to 40 ft., and are held in position by three spuds (36 in. square), two at the bow and one at the stern. The machinery for operating dredges varies greatly, the best recently constructed dredges being equipped with machinery for raising the dredge on the forward spuds (known as pinning up) instead of by swinging the dipper as formerly. The dredge is moved forward in the cut by means of the dipper arm, and the width of the cut is usually from 15 to 20 ft. The capacity of the dredge dipper varies from 2 to 5 cu. yd. in rock work and from 4 to 7 cu. yd. for earth work. The amount of material removed by one dredge per hour varies from 20 to 100 cu. yd. in rock, and from 75 to 125 cu. yd. in earth. The best type of dredges, however, in soft earth and under favorable conditions are capable of removing from 250 to 300 cu. yd. per hr. The time delayed for repairs usually varies from one-fifth to one-third of the time actually worked.

After the entire width of the area to be improved has been worked over by the dredge, cut by cut, the derrick scow follows after to remove such loose pieces of rock as may have been left projecting above the required depth. The derrick scows are usually from 80 to 100 ft. long and from 20 to 25 ft. wide and they are equipped with an ordinary hoisting engine and derrick capable of lifting from 12 to 18 tons, and a complete diving outfit. When lifting the boulders, the derrick scow is pinned up and supported on two spuds, each about 1 ft. square. The material to be removed is found by means of an iron bar, about 30 ft. long, suspended from the side of the scow to the required depth. Any obstruction struck by this bar as the scow is swept over the improved area is removed by the derrick by means of a chain, which is placed in position by a diver.

After the area has been thus cleared of obstructions an examination is made on the part of the United States to determine whether the required depth has been secured. This examination consists in sweeping the entire area with bars suspended to the required depth. These bars (about 20 ft. long) are suspended by chains from a raft (100 ft. long and 20 ft. wide) built of squared timbers, the raft (or "sweep scow") being held in position by a rope leading to a head anchor and pulled back and forth by means of ropes leading to side anchors. The bars are raised or lowered by winches. Any obstruction found during this examination is removed by the derrick scow with diving ~~o~~

fit. During the progress of the work, as well as during this final examination, constant attention is paid to the water gage in order to allow for the fluctuations in the water surface. Following this examination and on the completion of the work required under the contract, the final survey is made, which survey consists in the taking of soundings at regular intervals as described above. On this final survey and on the original survey depend the estimate for final payment.

At Ballard's Reef the material excavated was limestone bedrock, clay, hardpan and boulders. Generally there was from one to two feet of loose material overlying the bedrock. About 50% of the material was hardpan and clay. The material within about 75% of the area improved required to be drilled and blasted before removal. In this material one drill boat, equipped with three drills and working double shifts, was used to provide work for one dredge.

At Lime Kiln Crossing the material was mainly limestone bedrock, with no overlying material. Within the entire area it was necessary to do drilling and blasting before dredging. In this material two drill boats (each equipped with three drills and working double shifts) were used to provide work for one dredge.

At Amherstburg Reach the material was limestone bedrock, clay and boulders. Generally there was from one to two feet of loose material overlying the bedrock. Within about 75% of this area it was necessary to do drilling and blasting before dredging. On this work two drill boats (each equipped with three drills and working double shifts) were used to provide work for two dredges continuously and for a part of one season three dredges.

TABLE LXXXIII. DREDGING DETROIT RIVER, 1900-1903

	Ballards Reef	Lime Kiln Crossing.	Amherst- burg Reach.
Cu. yd., above 23 ft. depth (place measure)	74,143	101,072	98,332
Cu. yd., total (place measure)	135,548	121,707	209,821
Cu. yd., total (scow measure)	153,007	168,633
Area dredged, sq. yd.	225,000	61,000	225,000
Average depth dredged, pay material	1 ft.	5 ft.	1.3 ft.
Average depth dredged, total exc.	1.8 ft.	6 ft.	2.8 ft.
Average depth of water over material	21 ft.	18 ft.	20.7 ft.
Dredge hours, worked	7,248	3,945	9,021
Dredge hours, delayed	5,386	1,490	2,890
Dredge hours, total	10,634	5,435	12,911
Dredge months (12-hr. days)	1 34	5 17.4	3 39
Cost per month	\$3,000	\$3,200	\$3,200
Total cost	\$102,000	\$55,720	\$124,800
Cost per cu. yd. (place measure), pay material . .	\$1.38	\$.55	\$1.27
Cost per cu. yd. (place measure) total exc.	\$.75	\$.46	\$.60
Average cu. yd. per hr., working time	19.0	43.0	23.3
Average cu. yd. per hr., total time	12.8	22.4	16.2
Maximum cu. yd. per hr., soft material	150	250	300

SUBAQUEOUS ROCK EXCAVATION

739

TABLE LXXXIV. DRILLING

	Ballards Reef.	Lime Kiln Crossing.	Amherstburg Reach.
Drill hours worked	24,442	37,746	38,441
Drill hours delayed	982	1,278	
Drill hours, total	25,424	39,024	38,441
Number of holes drilled	30,023	29,236	35,432
Number of feet drilled	191,850	240,591	181,421
Ft. per hr., actual work	7.9	6.4	4.7
Ft. per cu. yd., pay material	2.6	2.4	1.8
Ft. per cu. yd., total exc.	1.4	1.9	0.9
Distance between holes	5 ft.	5 ft.	5 ft.
Average depth of holes	6.2 ft.	8.2 ft.	5.1 ft.
Average depth of pay material	1.0 ft.	5.0 ft.	1.3 ft.
Percentage of drilling below pay depth	84.0%	37.5%	75.0%
Number of pounds of 60% dynamite	110,305	222,396	263,072
Lb. per cu. yd., pay material	1.5	2.2	2.7
Lb. per cu. yd., total exc.	0.8	1.8	1.2
Total cost of drilling	\$59,235	\$105,245	\$96,470
Per cu. yd., pay material	\$.80	\$1.04	\$.98
Per cu. yd., total exc.	\$.44	\$.865	\$.46
Per ft. drilled	\$.31	\$.44	\$.53
Per drill hour	\$2.25	\$2.69	\$2.51

ITEMS OF COST.

Ballards Reef —

25,424 drill hours at \$.80	\$ 20,340
110,305 lb. dynamite at \$.15	16,545
2,450 tons of coal at \$3.00	7,350
Repairs (approximate)	5,000
Miscellaneous supplies	5,000
Depreciation of plant	5,000
Total	\$59,235
Tug service included in dredging.	

Lime Kiln Crossing —

39,024 drill hours at \$.80	\$ 31,220
222,400 lb. dynamite at \$.15	33,360
3,555 tons of coal at \$3.00	10,665
Repairs (approximate)	5,000
Miscellaneous supplies	5,000
Depreciation of plant	5,000
Tug service, 30 mo., at \$500	15,000
Total	\$105,245

Amherstburg Reach —

38,441 drill hours at 80ct.	\$ 30,750
263,372 lb. dynamite at 15ct.	39,500
3,740 tons of coal at \$3	11,220
Repairs (approximate)	5,000
Miscellaneous supplies (approximate)	5,000
Depreciation of plant (approximate)	5,000
Total	\$ 96,470
Tug service included in dredging.	

TABLE LXXXV. DERRICK SCOWS

	Ballards Reef. 11.2 mo. at \$970 \$10,865	Lime Kiln Crossing. 13.0 mo. at \$970 \$12,610	Amherstburg Reach. 16.0 mo. at \$970 \$15,520
Cost	Tug service included in dredging.	Tug service included in dredging.	Tug service included in dredging.
Cost per sq. yd. of area improved ...	\$.0475	\$.22	\$.07
Cost per cu. yd. of material removed by diver	\$5.73	\$2.84	\$2.04
Summary of cost.			
Dredging	\$102,000	\$ 55,720	\$124,800
Drilling	59,235	105,245	96,470
Derrick scows	10,865	12,610	15,520
Totals	\$172,100	\$173,575	\$236,790
Cost per cu. yd. of pay material ...	\$2.32	\$1.718	\$2.41
Cost per cu. yd. of total excavation	\$1.27	\$1.425	\$1.18

Basis upon which estimates of cost were made.

Dredge crew —

1 Captain at \$125 per month	\$125
1 Runner at \$90 per month	90
1 Cranesman at \$90 per month	90
1 Fireman at \$55 per month	55
3 Deckhands at \$40 per month	120
1 Scowman at \$40 per month	40
1 Cook at \$50 per month	50
1 Watchman at \$40 per month	40
Total	\$610

Tug crew —

1 Captain at \$115 per month	\$115
1 Engineman at \$100 per month	100
1 Fireman at \$55 per month	55
1 Deckhand at \$40 per month	40
Total	\$310

Subsistence of 14 men per month	\$150
210 tons of coal at \$3	630
Repairs and supplies per month	500
Repairs at the end of season, per working month	500
Depreciation in value of plant per month of operation equals 1/3 of 10% of value of plant.	

Drilling.

3 1/2 men per drill (at \$2.50 per day of 11 hr.) equals 80ct. per drill per hr.

Derrick scow.

1 foreman at \$90 per month	\$ 90
1 engineman at \$85 per month	85
1 diver, 25 days, at \$10 per day	250
1 diver's helper, at \$75 per month	75
6 deck-hands, at \$50 per month	300
15 tons of coal at \$3	45
Repairs and supplies per month	50
Depreciation in value of plant	75

Cost per month

From an article in *Engineering News* (Aug. 16, 1906) I have compiled the following data relative to work on the Detroit River:

SUBAQUEOUS ROCK EXCAVATION

741

Section No.	2	4
Location	Lime Kiln Crossing.	Amherstburg Reach. Hackett's Range.
Contract prices —		
Above 22 ft. grade, per cu. yd. bank measure	\$3.25	\$2.40
Bet. 22 ft. and 24 ft. per cu. yd. bank measure	\$1.625	\$1.20
Drilling equipment —		
Drill boats	2	4
With drills	6	10
Drilling work —		
Area, sq. yd.	39,000	120,000
Total yardage (estimated)	56,400	118,800
Pay yardage (estimated)	51,800	95,700
A. v. depth of material, ft.	4.2	3
Holes drilled	17,212	36,479
Holes drilled per drill boat	8,606	9,120
Holes drilled per drill	2,869	3,048
Cu. yd. per hole, total	3.3	3.2
Cu. yd. per hole, pay	3	2.7
Av. depth of holes, ft.	9.6	7.1
Holes spaced, ft.	5 x 5	5 x 5
Ft. drilled	165,011	260,313
Ft. drilled per drill boat	82,505	65,078
Ft. drilled per drill	27,502	28,031
Ft. per cu. yd., total	2.9	2.2
Ft. per cu. yd., pay	3.2	2.7
Drill hr. worked	19,358	34,729
Rate of drilling, ft. per hr.	8.5	7.5
Dredging equipment —		
Dredges	2	4
Derrick scows	1	1
Tugs	2	3
Scows	Others	Others
Dredging work —		
Total hr. dredges on work	1,386	7,594
Total hr. idle	392	2,204
Total hr. working	994	5,390
Per cent. idle	28	29
Area, sq. yd.	23,000	225,000
Cu. yd. above 22 ft.	13,003	78,260
Cu. yd. bet. 22 ft. and 24 ft.	17,578	100,893
Total pay yardage	30,581	179,153
Cu. yd. overbreak	2,645	43,482
Per cent. overbreaks	7.7	5.1
Total yardage	33,226	222,635
Total yards per dredge	16,613	55,659
Pay yards per dredge	15,291	44,788
Pay yards per dredge per hr. working time	15.4	8.3
Pay yards per dredge per hr. total time	11	5.9
Total yards per dredge per hr. working time	16.6	10.5
Total yards per dredge per hr. total time	12	7.5
Explosive (Dynamite) —		
Explosive used, lb.	170,669	328,444
Explosive used, lb. per hole	9.9	9
Explosive used, lb. per foot	1.03	1.26
Explosive used, lb. per cu. yd., total	3.08	2.76
Explosive used, lb. per cu. yd., pay	3.29	3.44

Operation of the Drill Boat "Hurricane" on Detroit River.

Further data on the cost of the submarine rock drilling in the Detroit River are given by Mr. C. J. Levey in *Mine and Quarry* (and in *Engineering and Contracting*, Oct. 9, 1912), and from his article I have abstracted the following:

The work comprises the construction of a second ship channel, 22 ft. in depth, so that traffic can be divided, the north-bound vessels using the present 600-ft. channel between Bois Blanc Island and Amherstburg, as at present, and the south-bound vessels using the new channel, outside of Bois Blanc Island. This new passage, known as the Livingstone channel, begins at Lime Kiln Crossing, north of Stony Island, and extends 11 miles, to deep water in Lake Erie. It is joined about five miles from Lake Erie by the north-bound channel, and this double channel will be 500 ft. in width. The northern six miles of single channel will be 300 ft. wide.

Section 3 involved excavation entirely under water. It consisted of a strip 18,250 ft. long, running south from the northern end of Bois Blanc Island. The amounts of material to be removed were about 1,500,000 cu. yd. of dredging, classed as earth, and consisting of silt, sand, boulders, etc. There was also an amount of rock, estimated at somewhat over 500,000 cu. yd.

The contract for Section 3 was let to Messrs. O. E. Dunbar and P. B. McNaughton, at a price of 50 ct. for earth excavation, and \$2.80 per cu. yd. for rock, all bank measurement. The contractors sublet the entire work, dividing the territory into three sections, each 100 ft. wide and 18,250 ft. long. The loose material above the rock was removed by dredges, loaded into scows, and dumped into Lake Erie. With this material out of the way, the average depth of water was from 10 to 12 ft. The method of removing the rock, adopted by all the contractors, was to employ reciprocating rock drills, mounted on boats, of which the M. Sullivan Dredging Co. has operated three, the Dunbar & Sullivan Dredging Co., two, and the Buffalo Dredging Co., four. These nine boats carried, in all, 35 drilling machines, the average number of drills per scow being four.

Methods of Operation. The rock drilled consisted of limestone and dolomite, soft in some places but containing hard streaks in others. The depth of holes drilled ranged from 5 to 16 ft., as the surface of the rock was sloping. It was necessary to drill to a minimum depth of 24 ft., in order to make sure that no material was left at, or above, the 22-ft. level. No payment was made for material taken from below the 24-ft. level. Full payment, on the rate above named, was made down to and including 22 ft. From 22 to 24 ft. half the above rate was paid. The holes varied from $3\frac{1}{2}$ to 5 in. in diameter at the top, and were spaced 5 ft. apart in both directions. The scows drilled from 15 to 22 holes from one setting of the boat, depending on the number of drills which they carried. Each blast consisted of ten or more ranges, or rows, so that the number of holes shot at one blast varied from 150 to 450. After the rock was broken up

by blasting, it was removed with dredges. Part of it was dumped into Lake Erie, and along the shore of the river, in such a way as to leave a 5-ft. depth of water at all points. About 150,000 tons each year were taken to a crusher plant.

Drill Scows and Equipment. The drill boat *Hurricane* will serve to give an idea of the equipment generally employed on this undertaking. A general view of the *Hurricane* is shown

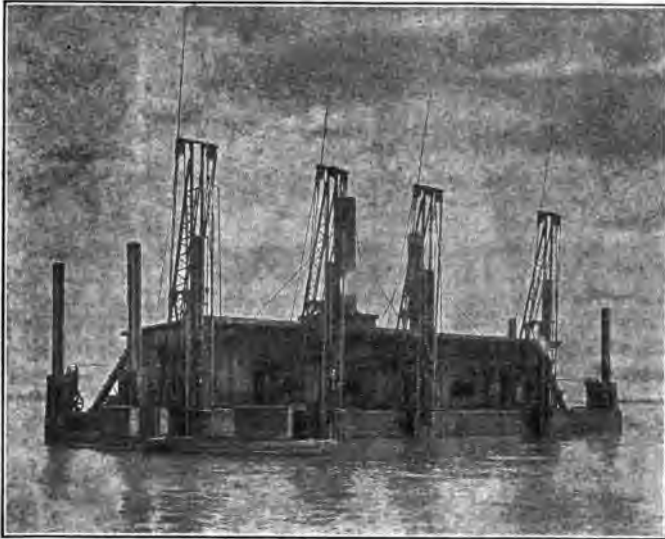

Fig. 171. Drill Boat *Hurricane*.

by Fig. 171. The boat is 100 ft. long, by 32 ft. beam, and 7 ft. in depth. An interesting feature of this scow is that it was originally built as two boats, 32 x 50 ft. in size. These had been used by Mr. Dunbar for some work on the Coast. In bringing them into the Detroit River, it was necessary to cut them in two, making them 25 x 32 ft. Instead of making two small boats of this outfit, it was decided to build one large one; so the four steel sections were butt-strapped together and internally braced with 12 x 12-in. oak trusses and iron cross bars, making the whole structure firm and rigid.

Owing to its origin, the boat contains two boilers instead of one, for supplying steam to the drills, pumps, etc. These are of the Scotch marine pattern, one being of 80 hp. and the other 140 hp. Coal for the boilers was hauled on the deck of the

scow from Amherstburg, and shoveled into the bunkers by hand. Some of the other scows had special arrangement for transferring the coal, without the necessity of hand shoveling. The boilers burned about 12 tons of coal per 24 hr. day, which means 3,000 lb. per drill per 11 hr. shift. Two shifts were worked each day.

The boat was anchored in position for drilling by four spuds, one in each corner, equipped with racks, by means of which they were lowered to rock by small duplex engines at each spud. In order to give a solid and motionless drill platform, the spuds were forced down, until a portion of the weight of the boat rested upon them. This held the boat firmly against the river current. It was also anchored by end and side cables, leading to anchors in the river bed. When necessary to change the position of the drill boat, for starting a new line of holes, or to permit blasting, the two steam windlasses, one at each end of the boat, took up or paid out the cables. Of course, for any important move, tugs were employed.

Drill Mountings. The boat carries four drills, each mounted on a structural steel frame, giving a 19-ft. lift or feed. Fig. 172 shows a more detailed view of a similar frame, with the drill in place. The drills were fed and hoisted by means of a hydraulic cylinder and piston, suitably equipped with three-way valves for admitting water under pressure to raise the drill, and for discharging it, as the drill was fed down. Water for the hydraulic cylinders was supplied by two pairs of duplex steam pumps, 12 x 5½ x 10 in., at about 200 lb. pressure. The front part of the drill frames was mounted, to permit sliding, on a 6 x 8-in. sill, protected by a 4 x ¾-in. steel plate. The rear part of the frame bore on a 6 x 8-in. block of wood, which slid on a similar steel rail, fastened to the deck. To keep the drill in place, while working at a hole, eyebolts were screwed into the deck every 5 ft., and the frame was locked by means of a hook at the back of the frame, which was snapped into the eye-bolt. The drill frames were slid along the deck by means of a chain, running the entire length of the boat, and operated by a double-acting, hydraulic cylinder, 12 in. in diameter and 11 ft. long, inside the drill house. To move one of the frames, a pronged piece of steel was caught into a convenient link of the chain, the other end being attached to the base of the frame. The hydraulic cylinder was then started and the frame moved the necessary distance. Steam was furnished the drills by means of pipes with both swing and slide joints. They permitted the frame to be moved along the deck the necessary distance, without changing the steam connections. The swing joint is similar to that in familiar use on stone channeling machines. A slide joint was

used in the pipe, which ran vertically up the frame, for connection to the drill cylinder. The rigid pipe on the frame was 2 in. in diameter, and the sliding pipe 1½ in.

Water, for jetting out the drill holes, was supplied from a duplex pump 7 x 4½ x 6 in., with 4½-in. suction, and 2½-in. discharge. One jet, of course, was supplied at each frame. The diameter of the nozzle was ½ in., supplying 2,390 cu. in. of water per cutting minute per jet, or 71.3 cu. in. of water per cu. in. of rock cut. The pump was run at a speed of 50 strokes per min.

The steam pressure furnished by the boiler was 100 lb., and the average length of feed pipe, from the boiler to the drill, was about 75 ft. The diameter of the main steam pipe was 3 in. The miscellaneous equipment of the drill boat included a dynamo and small engine for making electric light, a blower and small engine to operate it, also blacksmith tools for sharpening and tempering drill steel, and making temporary repairs on the machinery. Two spare drills were carried, and a powder boat, for carrying the dynamite, was part of the equipment.

The crew of the *Hurricane* consisted of 14 men—a driller and helper for each machine, one blacksmith, two blacksmith's helpers, one fireman, one powder man or blaster, and one foreman. The men lived on shore and boarded themselves, being carried to and from their work by the company's tugs, from Amherstburg. There was also a superintendent or walking boss in charge of both the boats.

Submarine Drills. Some description may properly be given here of the details of the drills which were used for this class of work. The drills on the *Hurricane* during the last season were all of the Sullivan class "71-14," 5-in. cylinder, submarine pattern. The drill has a length stroke of 8½ in. and is capable of boring holes 40 to 50 ft. in depth, with a diameter of 2½ to 5 in. It is fitted with 1½-in. hose, or pipe connections, for steam or air, requires 18 hp. for operation, and weighs 980 lb. bare. The valve motion is of the air thrown, "differential" pattern, such as is ordinarily used in the regular "differential" Sullivan drills, employed for lighter work.

Drill Steel. The steels which these machines employed were 35½ ft. long, with a section of 1¾ in., and the cutting bit upset to 3½ in. gage.

The depth of holes drilled during the past season by the *Hurricane*, averaged from 14 to 16 ft. Nineteen holes were put in to a row, and there were 12 rows making 228 holes to each blast.

Sand Pipe. A device was employed which added greatly to the speed and efficiency of the drilling and to the economy of



Fig. 172. Drill Frame on a Drill Boat.

drill steel. This was the sand pipe, in effect, a heavy cast steel funnel about 18 in. across the flaring portion, and with a pipe or spigot, some 4 ft. long, of sufficient diameter to provide about $\frac{1}{8}$ -in. clearance for the drill steel to work in. This was lowered at the starting of a fresh hole, by means of a circular casting, or frame with arms at each side, under the neck of the funnel. The

pipe was allowed to sink by its own weight through the sand, which in nearly all parts of the work had been washed by the current over the surface of the rock. The weight of the pipe, which was of steel, and the pressure of the sand around it held it firmly in place.

The Charging Tube. As ordinarily made this consists of a section of 2-in. piping, about 12 ft. long, slit to admit the sticks of powder. At the upper end of this pipe is 12 ft. of 1¼-in. pipe. To the upper end of this, again, is fastened a ring, so that the entire tube can be lowered by block and tackle fastened to the top of the drill frame, with a rope for operation from the deck. A wooden stick ¾ in. in diameter and 25 ft. long, runs through the pipe, for ramming the powder out of the charging tube, and into the hole. When loading, the stick is pulled out of the charging tube, and held in place by a wooden wedge.

The process of loading the holes is as follows: The hole is first thoroughly cleaned by the drill runner and his helper; they then call the powder man, who brings the amount of powder proper for the hole. This powder is in the form of "Pluto" dynamite, of 66% strength, made up in sticks 1¼ in. in diameter by 15½ in. long. Each one weighs 1¼ lb. Twenty to 30 sticks are required for each hole, depending on the diameter and depth. The powder man shoves the sticks up into the bottom of the charging tube, forcing the first one up with the second, and so on, until the pipe is full. The last stick is wrapped with wire or rope, or a small wedge is used, to keep the sticks from falling out. The tube is then lowered into the completed hole, and the powder forced into place, by means of the rammer, or loading stick, worked by two men. Two tubes full of sticks are required to provide a charge for the hole.

The following data as to footage and costs relate to the drill boat *Hurricane* during the season of 1911, when she was equipped with four Ingersoll-Rand 5½-in. drills. They are quoted from "Rock Drilling," by R. T. Dana and W. L. Saunders (pp. 238-240).

			Cost per shift.	Cost per ft. in cu. yd.	Cost per day
			cts.	cts.	cts.
4 drillers	3.02½		\$12.10		
4 helpers	2.42		9.68	\$ 21.78	5.58
1 blacksmith	3.62		3.62		
2 blacksmith's helpers	2.42		4.84	8.46	2.18
1 fireman	2.75		2.75	2.75	.70
1 foreman (day) per month	121.00	12.8%	4.64	4.64	1.20
1 foreman (night) per month	110.00	11.7%	4.25	4.25	1.10
1 powder man	3.30		3.30	3.30	.84
Day shift			40.93	10.50	15.16
Night shift			40.54	10.40	15.02
Total labor			\$ 81.47	10.45	15.07

	Cost per shift.	Cost per ft. in cu. yd. cts.	Cost per day in cu. yd. cts.
60% dynamite 1,172 lb. at 12ct., 2 shifts	\$140.64	18.05	26.00
Coal, 12.7 tons at \$3.15, 2 shifts	40.00	5.15	7.40
Oil, 5.2 gallons at \$.40, 2 shifts	2.08	.27	.38
Total	\$264.19	33.92	48.85
Plant \$45,000, interest and depreciation at 2% per working month per two shifts	84.60	4.44	6.40

The following is a general summary of data on file in the government office at Amherstburg, Ontario, obtained with the consent of the contractor:

"The following figures for cost per lineal foot drilled and per cubic yard of pay rock, are based on the average performance for a period of four months of 204 shifts. The average depth of hole was taken as 12 ft. The holes were drilled about three feet below pay grade and the cubic yards of pay rock are figured on that basis.

"Average over four months, 779 ft. drilled per day.

"Average over four months, 300 ft. drilled per shift.

"Average over four months, 541 cu. yd. of pay rock per day.

"Average over four months, 270 cu. yd. of pay rock per shift."

No account has been taken of the contractor's overhead charges, profit, cost of getting plant into operation in the spring and cleaning up in the fall, storing equipment during winter, legal expenses, insurance, charity, etc.

	May	June	July	August
Shifts worked	48	52	52	52
Hours worked	481	561	561	557
Hours delay	44	21	11	15
Number of holes	1,644	2,165	1,505	1,317
* Number of holes per shift	34	42	29	25
Lineal feet drilled	20,643	22,929	19,603	16,139
Depth of holes	12.56	10.50	13.02	12.28
Dynamite, 60%	18,517	29,926	37,865	33,219
Coal, tons	308	328	332	327
* Feet per day	860	882	754	622
* Feet per drill hour, working ...	10.72	10.41	8.75	7.25
* Feet per drill hour inclu. delays	9.83	10.03	8.58	7.06
Feet per man hour	2.79	2.80	2.45	2.02
Labor per day, dollars	81.57	81.47	81.47	81.47
* Labor per foot drilled, cents ...	9.48	9.24	10.81	13.10
* Coal per foot drilled, in pounds .	29.6	28.6	33.8	40.5
Coal per cu. yd. pay rock, lb.	14,580	15,160	13,970	11,320
* Cubic yards per day	607	583	538	436
* Cubic yards per shift 11 hours	304	292	269	218

The items marked * are deductions from the data on file.

Work on this undertaking was begun in the spring of 1908, and was prosecuted during the period of navigation in the five succeeding seasons.

Excavation at Buffalo, N. Y. I am indebted to an article by Mr. Emile Low in *Engineering News* July 6, 1905, and to information furnished by the Buffalo Dredging Co., for the following record of the work of excavating subaqueous rock at Buffalo, New York. The rock was flinty limestone, blocky and full of seams, and very hard.

SUBAQUEOUS ROCK EXCAVATION

749

The following table gives the record of work by 5 drill boats:

Drill boat.	Value of boat.	No. of drills.	Days worked in 1903	Av. depth of hole ft.	Ft. per drill per 24-hr.
No. 1	\$18,000	3	94	4.34 ft.	94
No. 2	30,000	4	78	4.55 ft.	86
No. 3	15,000	2	28	4.27 ft.	68
No. 4	15,000	2	38	4.91 ft.	99
Erie	20,000	2	41	4.21 ft.	92
Totals	\$96,000	13	274	4.44 ft.	86

Daily Cost of Operating One Drill Boat (11-hr. shift) :

	Per day
1 foreman, \$100 per month	\$ 3.85
1 foreman, \$60 per month	2.31
4 drillers, \$3 per day	12.00
1 blacksmith, 30 ct. per hr.	3.30
2 blacksmith helpers, 25 ct. per hr.	5.50
4 deckhands, 20 ct. per hr.	8.80
1 blaster, 27½ ct. per hr.	3.03
Total labor cost per shift	\$38.79
1 ton of coal *	3.00
Oil and waste	0.50
Tug hire	6.00
Repairs, etc.	4.70
Total supplies per shift	\$14.20
Grand total	\$52.99

* Should be 3 tons according to Buffalo Dredging Co.

The holes were spaced 4 x 5 ft. The average depth of cut was 2.44 ft., the holes being drilled 2-ft. deeper. The rock was dredged to a depth of 23 ft. The boat was equipped with Rand drills and a boiler, 7 x 12 ft. in size. The blacksmith used a hydraulic hammer.

The cost of drilling and blasting 70,000 ft. of hole averaged as follows:

	Per ft.				
Labor	\$0.25				
Explosives	0.110				
Coal, oil, tug	0.110				
Interest (6%) and depreciation (10%)	0.222				
Total cost per ft. of hole	\$0.692				
Cost per cu. yd. (place measure) of pay material:					
Boat	Labor	Coal repairs, tug, hire, etc.	Explosives	Int. & Dep. (16%)	Total
No. 1	\$0.342	\$0.082	\$0.148	\$0.180	\$0.702
No. 2	0.309	0.053	0.148	0.242	0.754
No. 3	0.436	0.130	0.148	1.050	1.764
No. 4	0.427	0.109	0.148	0.614	1.298
Erie	0.365	0.087	0.148	0.568	1.169
Average	\$0.342	\$0.076	\$0.148	\$0.299	\$0.865

The cost of the dredging plant was as follows:

Dredge No. 7	\$100,000
2 steel scows	32,000
1 tug	18,000
Total	\$150,000

Dredge No. 7 has a dipper of 6½ cu. yd. (struck measure) capacity.
Cost of Operating Dredge One Month:

1 runner	\$125	
1 runner	100	
1 cranesman	100	
1 cranesman	90	
1 oiler	60	
2 foremen at \$60	120	
2 scowmen at \$50	100	
2 scowmen at \$50	100	
1 watchman	50	
1 cook	50	
1 cook	40	
Total		\$935
Board of 14 men at \$15	\$210	
240 tons of coal, \$3	720	
Oil and waste	20	
Repairs *	500	1450
Grand total		\$2385

* According to Buffalo Dredging Co. this item should be \$1500 instead of \$500.

Cost of Operating Tug One Month:

1 captain	\$125	
1 engineman	115	
2 firemen	110	
Total wages		\$350
Board of 4 men at \$15	\$ 60	
90 tons of coal at \$3	270	
Oil, etc.	10	
Repairs	200	540
Grand total for tug		\$890

In two months, 37,570 cu. yd. of rock (scow measure), or 18,785 cu. yd. place measure, were dredged at a cost of 34.8 ct. per cu. yd. (place measure) for operating dredge and tug. These figures do not include interest and depreciation, which, if assumed at 6 and 10% respectively, would amount to \$24,000 per yr. This plant worked 4 months, hence \$6,000 should be charged per month for interest and depreciation, which would amount to \$0.636 per cu. yd. place measure for interest and depreciation.

The total cost per cu. yd. place measure, is as follows:

Drilling and blasting	\$0.866
Dredging	0.348
Interest and depreciation on dredge	0.636
Total	\$1.850

The cost of cleaning the bottom with divers has been omitted. According to the Buffalo Dredging Co., this item amounted to 20% of the contract price in one instance.

The cost of repairs to the dredge, according to the Buffalo Dredging Co., is as follows: In one set there are 14 dipper teeth, costing from \$290 to \$420 per set. These require sharpen-

ing every day and the cost of sharpening is about \$75 per set. When the teeth are resteeled the cost is greater. There is also the item of time lost when changing teeth. The cost of repairs for the season of 1904 was \$13,859 distributed as follows: Teeth, forging and blacksmithing, \$6,262; cables and chains, \$2,072; machine repairs, \$3,565; miscellaneous, \$1,960. The dredge was built in 1901 for \$115,000.

Cost of Harbor Excavation, Oswego, N. Y. In *Engineering News*, Feb. 15, 1894, Mr. Wm. Pierson Judson gives the following data on rock excavation in the inner harbor of Oswego, N. Y. Over an area of 4,500 sq. yd. the rock had to be excavated to a depth of 15 ft. Over 70% of this area the rock had a face of 1 ft. or less, and over the rest, the face was 2 ft. or less. The rock was graywacke sandstone in horizontal strata 1 to 2 ft. thick, with seams in which the drill often jammed. The rock varied greatly in hardness; the drill often cutting 10 ft. with one sharpening, and at other times wearing dull in 1 ft. The rock excavated was 2,956 cu. yd., let to Hingston, Rogers & O'Brien at \$2.75 per cu. yd., place measure. Work was begun June 30, 1893, with a very efficient plant.

The drill scow was $6\frac{1}{2} \times 26 \times 82$ ft., the bottom being of 8-in. oak, and the sides of 6-in. pine, and after a season's work showed no ill effects from blasts fired directly under it in 12 ft. of water. Its draft was $2\frac{1}{2}$ ft. A deck house 14×72 ft. housed boiler, engine and blacksmith shop. On one side of this house was a $6\frac{1}{2}$ -ft. track carrying two drill frames each, one a separate truck that could be moved by two men operating a 5-ft. lever and ratchet engaging a 10-in. pinion on the truck shaft. Each drill frame carried a 5-in. Ingersoll drill, suspended from a 6-in. x 12-ft. hydraulic lift set vertically in the drill frame. The great value of this hydraulic hoist was that it could pull a drill loose instantly when stuck in a seam. These hydraulic hoists were operated by a duplex Blake pump with a $7\frac{1}{2}$ -in. steam cylinder, $4\frac{1}{2}$ -in. water cylinder and 10-in. stroke, working under 80 lb. steam pressure. Steam for the drills, pump and $15\frac{1}{2}$ -hp. hoisting engine was supplied by a 30-hp. boiler burning $1\frac{1}{2}$ tons of coal in a working day of 22 hr. There were two crews of six men each, and a blacksmith and helper with each crew.

Range marks 10 ft. apart made it possible to locate a drill within 1 ft. of any desired spot. A $4\frac{1}{2}$ -in. casing pipe was lowered and forced into the gravel overlying the rock. This pipe had a double T, 2 ft. above the bottom, to allow drill chips to escape. The pipe remained in position until the hole was drilled and charged. The drill steel is 26 ft. long, the upper 14 ft. being $1\frac{1}{2}$ -in. machine steel, the next 10 ft. of $1\frac{3}{4}$ -in. steel, and the lower 2 ft. of 2-in. octagon steel with a $3\frac{1}{4}$ -in. square cross bit

tempered in a saturated solution of equal parts of sal ammoniac, salt and alum.

Holes were drilled 2 to 4 ft. below grade, and spaced 5 ft. apart in rows 5 ft. apart. The average depth of 1,000 holes was $5\frac{1}{4}$ ft. and the average time to drill each of these holes was 1 hr., although in rock free from seams a hole may be drilled in $\frac{1}{2}$ hr., whereas in seamy rock 3 hr. may be consumed. The maximum rate of penetration of the drill was 1 ft. in 4 min. About 12 drills per 22 hr. were sharpened. About 20 ft., or 240 lb., of 2-in. octagon steel was used for 6,000 ft. of holes.

Dynamite (75%) in waterproof cases, $2\frac{1}{2} \times 18$ in., gave the best results. The cartridge is placed in an iron loading pipe, which hangs by a small tackle from the drill frame. When the bottom of the hole is reached, a plunger, which is within the loading pipe, is unclamped and forced steadily down upon the cartridge, while the loading pipe is slowly hoisted. The plunger and loading pipe are next raised 4 or 5 ft. from the bottom; and in this position the charge is fired, one hole at a time, without moving the drill boat. From 2 to 6 lb., average $2\frac{3}{4}$ lb., of dynamite are fired in each hole. The entire time from the stopping of the drill to the firing, as just described is 3 min. in ordinary work, and often only $1\frac{1}{2}$ min. To shift the drill on its trucks 5 ft., lower the casing and start drilling a new hole takes about 2 min. and can be done in 1 min. Fourteen holes 5 ft. apart can be fired from one setting of the drill boat. The rock is broken up into pieces of 1 to 2 cu. ft. each. Occasionally the dredge dipper brings up a rock too large to drop through the dipper. In such cases the dipper is rested on the dump scow, while a hole is drilled in the rock with a hand drill, loaded with $\frac{1}{2}$ lb. of dynamite, tamped with cotton waste and fired without injury to the dipper.

The loading pipe, above mentioned, is worthy of description. Its lower end is a $2\frac{1}{2}$ -in. pipe 3 ft. long, with a $\frac{3}{8}$ -in. slot its full length. The upper end of this slotted pipe joins a 1-in. pipe 22 ft. long, within which works a $\frac{3}{4}$ -in. plunger 27 ft. long, having a 2-in. head at its lower end resting on the cartridge. The leading wires from the cartridge pass out through the slot. A clamp at the upper end of the 1-in. pipe holds the plunger until ready to use. The device is all of iron and works perfectly. While the exact cost to the contractors is not known, the following estimate is based upon 1,000 cu. yd. of rock, for which 1,650 holes, aggregating 8,660 ft., were drilled in 33 days of 22 hr. each:

33 days' wages of drill crew, at \$31	\$1,023.00
4,000 lb. of 75% dynamite, at 17 ct.	680.00
1,800 exploders at 3 ct.	54.00
49 $\frac{1}{2}$ short tons of soft coal, at \$3	148.50

42.33 gal. cylinder oil for drills, etc., at 30 ct.	12.70
55 gal. kerosene for lanterns, at 12 ct.	6.60
260 lb. octagon steel, at 15 ct.	39.00
55 lb. machine steel, at 4 ct.	2.20
General machine shop repair bill	34.00

Total, 1,000 cu. yd., at \$2 \$2,000.00 *

To dredge 1,000 cu. yd. required about 10 days' work of 10 hr. each, costing, say, \$500, making a total cost of \$2.50 per cu. yd. of rock excavation, not including plant interest and depreciation. While 1,000 cu. yd. were removed above grade, for which the contractor was paid, there was probably an equal amount of loose rock left below grade, for which, of course, no payment was made.

Excavation on the Welland Canal at Port Colbourne. For information from which I have compiled the following data relative to the work of deepening Port Colbourne Harbor and the Welland Canal, Canada, I am indebted to a number of sources.

In 1871 a contract was awarded on this work which contract included the removal of 15,000 to 20,000 cu. yd. of rock at depths of from 10 to 15 ft. under water. The contract price was \$6.50. After several months of ineffectual attempts to displace the rock with dynamite, this contract was abandoned.

A contract was awarded in 1875 calling for an increase in depth of water, from 12 ft. to a minimum of 17 ft. The contract price was \$9.90 per cu. yd. The rock was blue limestone thick with flint.

The drilling scow used was 30 x 50 ft. in size, with a draft of 2 ft. It was equipped with boiler and engine, two Ingersoll drills (5 x 8 in. cylinder), a blacksmith's shop, etc. The drills were 1¾ to 2¼ in. in size with + bits. Each drill worked in an independent frame sliding on a tramway. The drill scow was kept in position by 4 anchors. The crew comprised a foreman, a blacksmith and helper, 4 drill attendants, and 1 blaster and helper. Holes were drilled 5 ft. apart, 30 in. below the required depth. The lower end of the drill was steadied by a cast iron shell weighing 100 lb. This shell stood on three legs and the drills worked through the hole. The sludge was removed by a water jet. The cartridge was of tin, ⅞-15 in., and contained 2 to 5 lb. of pure nitroglycerin with a fulminate of mercury cap. The cartridge was placed in a tin tube 1½ in. x 20 ft. long, and carefully lowered, after which the tube was withdrawn. Each hole was exploded separately. The explosive cost \$1 per lb.

Mr. J. M. Hagean described in 1905 the later work of excavating the channels. This comprised drilling, blasting and dredging 300,000 cu. yd. (place measure) of very hard flinty limestone

* Charles James in *Transactions, Institute of Civil Engineers, V. 80 (1885)*, p. 233; J. M. Hagean, *Transactions Canadian Society of Civil Engineers*, 2, 19 (1905) pp. 144-163.

over a large area. The cut ranged from 6 in. to 6 ft., and holes were driven 2 to 3 ft. below grade. Owing to storms, the work was much delayed.

Drilling was accomplished by a drill boat (100 x 27 x 6 ft.) equipped with a boiler, large steam pump, drill frames, and drills with hydraulic feeds. The boat was held steady by 4 oak spuds of 12 x 16 in. at the corners. The drill steel was 1¼ in. round steel. The drill had an 8½-in. stroke. The drill frames were mounted on rails and were moved by a ratchet.

The charges were loaded by placing them in a cylinder, inserting this in the hole and pushing the charge out. Dynamite of 75% grade was used. Holes were 6 ft. apart, and 7½ lb. of dynamite was charged in an 8-ft. hole.

The progress of one boat for 5 months is here given. The work recorded was subject to much interruption by storms. Days worked included the time to set up on ranges and the time the boat was on the range but could not work on account of storms. Night and day crews were worked.

Month, 1904	Shifts (12 hr.)		Ft. drilled	Lb. Explosives	Ft. per hr. 3 drills
	worked	Holes			
April	49	2282	10,170	8527	18
May	43	1348	6,280	5624	12.2
June	50	1453	8,133	6947	13.5
July	43	1512	6,950	6104	13.4
August	43	1348	6,478	5511	12.5
			38,011	32713	

Dredging was done by means of two dredges each operating a 4-yd. bucket. Their performance varied greatly. As little as 250 cu. yd. a day was sometimes removed. Tests of one dredge in well drilled material resulted in 4,835 cu. yd. in 6 days of 12 hr. Deducting 5 hr. for repairs this gives an average of 65.5 cu. yd. per working hr. The excavated material was loaded into dump scows.

Drilling and Dredging, Galops Rapids of the St. Lawrence River. (*Engineering and Contracting*, Apr. 24, 1912.) This work consisted of the removal of very hard limestone bed rock to form a channel 17 ft. deep and 200 ft. wide. The current was very rapid and turbulent, the rate of flow being from 8 to 12 miles per hr.

The drill boat carried four 5-in. drills, was fitted with four power-operated spuds, and was anchored by five anchors weighing 1,500 to 2,900 lb. each. The boat had four wells 20 ft. long by 18 in. wide amidships through which the drills were operated. The general rule was to drill below grade a depth equal to half the distance the holes were apart.

The dredge used was a dipper dredge, equipped with four spuds and four chains leading to anchors.

SUBAQUEOUS ROCK EXCAVATION

755

The cost of operation of the drill boat per month was as follows:

Labor (12-hr. day):	
1 captain	\$100
4 drillers, at \$75	300
4 helpers, at \$30	120
1 foreman, at \$30	30
1 machinist, at \$60	60
1 smith, at \$70	70
1 helper, at \$30	30
1 blaster, at \$60	60
1 helper, at \$35	35
1 cook, at \$30	30
Total labor per month	\$835
Board and lodging:	
16 men at \$12	\$192
Fuel and supplies:	
Coal, 60 tons per month at \$4	\$240
Oil and waste	40
Smiths' coal	15
Steel iron and smiths' supplies	52
Total fuel and supplies	\$347
Grand total	\$1,374
Cost per drill hour	1.105
Cost per foot	0.049
Av. depth of cutting	6.5
Depth of cutting	0 to 11 ft.
Av. ft. drilled per hr. per drill	2.25
Holes spaced to average 20 sq. ft. per ft. of drilling.	
Drills average 1.66 cu. yds. per hr.	
1½ lb. 75% dynamite used per cu. yd.	

The cost of drilling, dredging, etc., for the entire work was as follows:

	Total Cost	Per cu. yd.
Salaries and board	\$117,755	\$1.57
Traveling and transportation	5,554	0.08
Fuel	33,883	0.45
Explosives	36,104	0.48
General repairs and freight	45,547	0.61
Towing	13,887	0.19
Interest and insurance	18,330	0.24
Miscellaneous, includes accident insurance, law, rental, minor expenses, etc.	6,665	0.09
Totals	\$277,725	\$3.71

Allowance was made for quantities excavated below grade, it being impossible to carry on this work with the same accuracy as work in calm water. The contract price was \$8.40 per cu. yd., for about 75,000 cu. yd.

Excavation at Ahnapee Harbor, Wisconsin. (*Engineering Record*, March 9, 1901, p. 223.) This work was performed by tripod-mounted steam drills located on a scow. Two old No. 5 Ingersoll drills were used for the first month and these were supplemented with two new drills of the same type during the remainder of the work. The bed of the Ahnapee River is seamy limestone covered with boulders, sand and gravel. The water was

4 to 8 ft. deep. The loose material was removed by dredges from a small part of the area.

Holes were spaced 6 x 4 ft., a "sand" pipe called a "ginger rocket," being used to guide the drills. Steels were first furnished with 3½-in. and next with 1¾-in. or 2½-in. bits, the 2½-in. being used in seamy rock.

A brass charging tube was used to facilitate loading, a hole being loaded as soon as drilled. A row of 8 holes was fired in one blast by electric batteries. The explosive used was 40, 60 and 75% gelatin powder, the average charge per hole being 9 lb. Equal quantities of 40 and 60% powder gave the best results.

The general data of the work are as follows:

Area drilled and dredged, ft.	50 x 680
Holes drilled	876
Av. depth of hole, ft.	8.4
Total feet drilled	7,426
Rock dredged, scow measure, cu. yd.	10,765
Cu. yd. of place measure loosened	6,601

About 4,800 cu. yd. of this 10,765 was cut over on docks. About 1,000 cu. yd. was handled twice, making the net quantity of rock removed, 9,765 cu. yd. scow measure.

The cost of the drill scow, drills, tools, etc., was \$1,531. Interest at 5% and depreciation at 5% amount to \$153. The cost of the work was as follows:

	Per cu. yd. scow measure.
Drilling —	
Interest and depreciation on plant	\$.015
Repairs and supplies to plant245
Explosives, wire, fuses140
Fuel019
Labor and overseer240
Contingencies023
Total, drilling	\$.682
Dredging —	
Repairs and supplies to plant	\$.005
Hire of tug030
Fuel for dredge and tug044
Labor and overseer245
Contingencies023
Total, dredging	\$.347
Total cost of rock removal	\$1.029

The foregoing information is from the Report of the Chief Engineer, U. S. Army, 1900, p. 3677.

Cost of Excavating Ashtabula Harbor. (*Engineering and Contracting*, Aug. 1, 1907.) Mr. E. C. Brown, Jr., gives the following costs of drilling and blasting shale rock under water in the work of providing new channels and slips for the new ore docks of the Lake Shore & Michigan Southern Ry. Co., at Ashtabula Harbor, Ohio. The finished grade was about 21 ft. below

water, the rock being dredged with dipper dredges after having been drilled and blasted.

The drill boats were about 85 ft. x 30 ft. and were held in place by 4 spuds located at the corners. The drills were Ingersoll-Sargeant steam drills supported on vertical frames having trucks to permit of horizontal movement along the edge of the boat. The drills were raised and lowered by hydraulic lifts. The boilers furnished steam for operating the drills, the pumps connected with the hydraulic lifts, the electric lighting plant and other machinery.

Drill boat "A" was equipped with three drills and drill boat "B" with two. The amount of explosive used was about $\frac{3}{4}$ lb. of 45% dynamite per ft. of drilled hole. A hole was charged by inserting sticks of dynamite with exploders and battery wires attached, into the bottom of a long pipe, the battery wires leading out through a slit in the pipe. This pipe was lowered into the hole, the charge shoved down with a ram-rod, and the pipe withdrawn. A wire spring attached to the dynamite prevented it coming out of the hole. The operation of the other drills was not interrupted during the time of the firing. About $\frac{1}{2}$ lb. of 45% dynamite was used per cu. yd. of blasted material, place or solid measure. In this class of excavation it is not necessary to drill the holes more than 6 in. to 1 ft. below grade.

Referring to the performances of the drill boat "B" it will be noticed that the cost of drilling and blasting at night was much less than by day. This is due to the fact that the work is done in the open lake without protection from wave action, and still weather prevails more often at night, making the operation of the boat less difficult. During the day, a day breeze often springs up as the sun comes up and goes down as the sun sets. Oftentimes this breeze is strong enough to stop operations.

Work with Drill Boat "A." Drill boat "A" worked days only. The average depth of holes was 6.15 ft. and their average distance apart was 6.7 ft. The wages paid labor and the prices of materials were as follows, a 11-hr. day being worked:

Foreman	\$4.85
Drillers	3.30
Helpers	2.42
Fireman	2.20
Blacksmith	3.00
Blacksmith's helper	2.20
Coal, per ton	2.70
Dynamite, 45%, per lb.15
Electric detonators, per dozen30
Tug service per transfer	5.00

The following is the record of work for the month of May, 1907:

Rock drilled and blasted 4,744 cu. yd. place measure.

	Per cu. yd.
Explosives	\$.067
Transfers by tugs032
Coal019
Labor, drilling and blasting067
Lost time, due to bad weather and breakdowns022
Repairs032
Miscellaneous003
Electric detonators005
Interest and depreciation038
Total	\$.285

The drilling was done with 3¾ to 4-in. percussive drills, the total depth of hole drilled being 2,853 ft. The total amount of explosive used was 2,134 lb., or 0.75 lb. per ft. of hole. The number of drills sharpened was 38, so that one drill was sharpened for each 75 ft. of hole drilled.

Work with Drill Boat "B." Drill boat "B" was worked day and night shifts. On the day shifts the average depth of holes was 9.1 ft. and the average distance between holes was 6.6 ft. On the night shift the corresponding figures were 9.5 ft. and 6.6 ft. The records of cost for the day shifts and for the night shifts for the month of May, 1907, are given separately.

There were 6,460 cu. yd. drilled and blasted by the day shifts at the following cost:

	Per cu. yd.
Explosives	\$.075
Transfers by tugs005
Coal017
Labor, drilling and blasting071
Lost time due to bad weather and breakdowns026
Repairs016
Electric detonators003
Interest and depreciation on plant023
Total	\$.236

The drilling was done with 3¾-in. drills, the total depth of hole drilled being 4,004 ft. The total amount of explosive used was 3,219 lb., or 0.804 lb. per lin. ft. of hole. The number of drills sharpened was 68, so that one drill was sharpened for each 59 ft. of hole drilled.

The work of the night shift was 6,805 cu. yd. drilled and blasted at the following cost:

	Per cu. yd.
Explosives	\$.070
Transfers by tugs005
Coal015
Labor, drilling and blasting054
Lost time due to bad weather and breakdowns029
Repairs006
Electric detonators003
Interest and depreciations on plant022
Total	\$.204

The drilling was done with 3¾-in. drills the total depth of

hole drilled being 4,218 ft. The total amount of explosive used was 3,148 lb., or 0.75 lb. per ft. of hole.

Boat "A" was transferred 30 times by tugs and boat "B" only 7 times, because the former was working in an exposed location and during the day time only and thus would have two transfers to the drilling ground in favorable weather, while drill boat "B" would remain on the site working day and night.

Repairs do not include sharpening drills, this being charged to labor of drilling and blasting. The number of drills sharpened on "B" during the week was 71, and the total number of feet drilled day and night was 8,222 making one drill sharpened for each 116 ft. of hole drilled.

One hole, as a rule, was fired at a time, and holes were fired as fast as they were drilled.

High Cost of Rock Excavation, Pier 14, New York Harbor. In the *Trans. Am. Soc. C. E.*, Vol. XXXII, 1894, Mr. John A. Bensel describes the method and cost of excavating 1,530 cu. yd. of mica-schist near Pier 14, New York City. The excavation was carried to 35 ft. below low water, or 40 ft. below high tide. A contractor began the work at \$25 per cu. yd., but finally abandoned the work. The crew consisted of 1 diver, 1 foreman, 2 blacksmiths and 5 deck hands; and, drilling from a platform with one Ingersoll drill (largest size), they averaged only 13¼ ft. of hole per shift.

Two 18 x 20-ft. platforms, floated out on pontoons and supported by 8 x 8-in. spuds 55 ft. long, were used. When standing on the spuds the platforms shifted up and down stream with the tides, 3½ ft. from the vertical. The platforms collapsed three times; one due to swell of a passing boat; once due to a blast; and the third time without apparent cause. While the platforms were being repaired, a crew of 2 divers and 10 men removed 85 cu. yd. of the blasted rock, at the rate of only 3.4 cu. yd. of loose rock per shift. Then a grab-bucket dredge was tried; and averaged 18 cu. yd. of loose rock a day for a week. The contractor then abandoned the work.

The Dock Department then built a large four-drill scow of 12 x 12-in. spruce, the dimensions being 22 x 33½ ft. x 6 ft. deep. The scow and plant cost \$5,000. This scow was not provided with spuds (a fatal omission), but was anchored with four pile-driver hammers of 3,000 lb. each. The drill rods consisted of two pieces of 1½-in. octagon steel, joined by a double ended chuck to make a total length of 45 to 50 ft. From Sept. 2, 1892, to Mar. 13, 1893, drilling was carried on without interruption (presumably working one shift a day) with four drills, and only 231 holes (2½ and 3-in.) were drilled, each averaging 7 ft. deep, which was 3 ft. below grade. Gelatin (95%) was used in blasting.

In dredging, clam-shell buckets, 4 and 7 cu. yd. capacity, a grapple and a bucket dredge were tried, with little difference in results, all being very disappointing. The solid rock dredged was 1,530 cu. yd., plus 450 cu. yd. of riprap, and it took 886 hr. work of the dredge to do this work, costing \$22,145 for the dredging alone! The amount of rock removed by the dredge was 4,805 cu. yd., measured in the scow; beside which 480 cu. yd. of rock (scow measure) were removed by divers. The total cost of this work was nearly \$70,000.

I think it would be hard to find a better example of money wasted in an attempt to do work by day labor instead of by contract. The failure of an inexperienced contractor evidently led the Dock Department into an expensive experiment. Another feature about this work that showed lack of experience was the failure to space the holes closer together, or to drill holes larger in diameter, or both. If that had been done the dredge would have been more effective. The mica-schist of Manhattan Island is an exceedingly tough rock, and it requires close spacing of holes for subaqueous work like this, in order to break the rock into small sizes. The Dock Department, however, spaced the holes 6 ft. apart on the north and south lines, and 5 ft. apart on the east and west lines, according to Mr. Bensel; although according to the scale drawings given by him the distances were 5 ft. and 4 ft. instead of 6 ft. and 5 ft., as stated in the text. The result of the blasting seemed to be to stack the broken stones against each other, and not to loosen and throw up the mass. Divers described this bottom as being oftentimes like a pile of grave stones, one stone lying against another.

Drilling and Blasting in Tennessee River. (*Engineering and Contracting*, Nov. 8, 1913.) Tuscumbar Bar is located in the Tennessee River about 211 miles below Chattanooga and is a black flint-limestone shoal about two miles long. The work consisted in drilling and blasting a channel 150 ft. wide and 5 ft. deep. This work is described by Mr. J. E. Hall in *Professional Memoirs*.

The depth of water varied from a few inches to 5 ft. at low water and boats having a shallow draft were required. The float used in 1911 was composed of 9 boats, each being 1 ft. deep, 5 ft. wide and 25 ft. long. These were arranged in three rows with three boats in each row making a platform 19 x 75 ft. A space of 1 ft. was left between the boats through which the drills were operated. In 1911 the boats were held longitudinally across the current by spuds. From one position of the float two lines of 12 holes each were drilled halfway across the channel. The holes were spaced about 6.25 x 7 ft. and were drilled 7 ft. below low water. Subsequent dredging proved the spacing too wide as

the blasted pieces were often too large to be handled economically and mud-capping was required.

In December, 1911, high water and bad weather terminated the season's work. The first season's (1911) work, during which 28,831 ft. of hole were drilled, cost 46 ct. per ft. of hole, not including interest, depreciation and general expense. The difficulties and cost increase with the depth of water, the increased

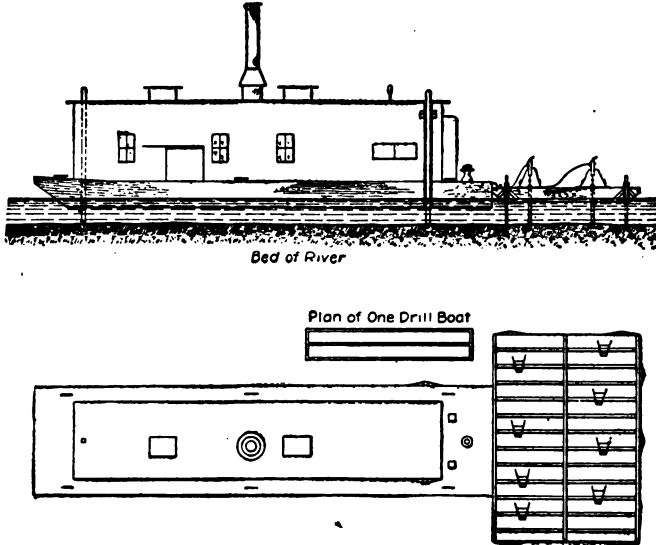

Fig. 173. Plan and Elevation of Drill Float and Tender, Tuscumbar Bar, Tennessee River.

current due to a rise of water making it difficult to hold the float in place and often destroying the blasting connections.

During 1912, thirteen boats (Fig. 173) each 1 x 5 x 25 ft. in size, were arranged lengthways with the current making a float 25 x 75 ft. A space of 1 ft. was left between the boats through which drilling was performed. The boats thus arranged were less affected by the current. The holes were spaced 4 x 6 ft. and were drilled 9 ft. below low water. Each float was equipped with 8 steam driven drills. There were 85,708 ft. of holes drilled in 1912 at a cost of 42.8 ct. per ft. exclusive of interest, depreciation and general expense.

The river channel for 5,000 ft. was drilled, half being done in 1911 and half in 1912.

During the first season the drills were all sharpened by hand.

but in 1912 a Leyner drill sharpener was installed which was operated with compressed air. This machine proved perfectly satisfactory, as it gave the bits more uniform gage so that there was no difficulty of one drill following another, and the bits sharpened by this machine seemed to stand the hard service better than those sharpened by hand. A considerable saving was also effected, as one blacksmith and helper were able to sharpen steel for 24 drills, while three blacksmiths and helpers were necessary to do this work by hand.

The seeming excessive cost of drilling here is due to the character of the rock, which is the very hardest of flint. It was found a very difficult matter to get steel that would stand this rock, and it was often necessary to change the bits several times in getting down one sweep of the drill, which is only 24 in. The slightest mistake in tempering would cause the bits to fail at once. In this connection it is interesting to note the difference between the rock at this place and the rock at Buck Island Shoals, 3 miles below this place, where rock excavation was carried on at the same time. The rock at Buck Island Shoals is soft oölitic limestone which can be drilled easily and rapidly, and the drill bits keep sharp indefinitely. In addition to the ease with which it can be drilled, it is also very easy to break up. While it was found necessary to space the holes at Tuscomb Bar 4 x 6 ft., a spacing of 7 ft. x 8 ft. at Buck Island was found ample, this spacing breaking the rock up better and leaving fewer large pieces than at Tuscomb Bar. The same plant and methods were used at both places. The cost per foot of drill hole at Buck Island Shoals was found to be \$0.25 against \$0.483 at Tuscomb Bar.

During the drilling season of 1912, 85,708 ft. of holes were drilled and blasted. It is estimated that each foot of drilling loosened up 0.88 cu. yd. and that 76,185 cu. yd. were made ready for removal by the dredges at a cost of \$0.543 per cubic yard for the drilling and blasting, and $\frac{3}{4}$ lb. of dynamite was used for each cubic yard blasted (about 9 ct. more).

When the river was at a favorable stage for drilling it was found that an entire day with a double crew was required to drill out, load and detonate all the charges for one setting of the drill unit. Whenever unfavorable conditions occurred from weather or high water the progress was considerably lessened.

The season's work for 1912 covered the heaviest part of the blasting, as it began at the upper end of the extremely shallow water and extended entirely below it. While the number of feet of holes drilled in 1912 was about three times the amount drilled in 1911, it only covered about the same channel area, viz.: 2,500 lin. ft. This was on account of the narrow spacing of the holes,

the additional depth drilled and also that this season's drilling covered the heaviest part of the work.

At the end of 1912 there was left an area undrilled equivalent to about 1,200 lin. ft. of channel.

	Ft. of hole.
Average day's work for 1 drill unit operated with a double crew . . .	432
Average hour's work	27
Average hour for 1 drill	3.3

The drill unit used for work here consists of a float for carrying the drills, and boat of the same type having a boiler with sufficient power for furnishing steam for all of the drills. The floats have been modified to some extent, it being thought best to deck them, since with the decks they are less apt to sink during the heavy wind storms which sometimes occur.

During the first season's work any boat having sufficient boiler power that could be spared from the plant was used as tender. The floats could be very quickly built and they were put to work in this way pending the building of a suitable tender. The type of boat built for this purpose was a barge 30 x 80 x 4 ft. in depth, provided with three spuds. It was equipped with a 90-hp. boiler, one Leyner drill sharpener, one compressor for operating same, and a steam capstan for handling the barge.

The drill sharpener was Leyner No. 2, and the sizes of steel for forming the bits were $1\frac{1}{4}$, $1\frac{3}{8}$, and $1\frac{1}{2}$ in. The sharpener was driven by air, the compressor in use being one manufactured by Chicago Pneumatic Tool Co., having a cylinder 9 in. for steam and air by 11-in. piston stroke, piston displacement 130 cu. ft. air per min. at 100 lb. pressure. This tender, equipped for the work, cost as follows:

Building hull, cost of labor and subsistence	\$ 1,348.66
Lumber and iron, nails, spikes, oakum, etc.	1,902.40
One 90-hp. Brownell boiler	900.00
One Leyner drill sharpener, No. 2	697.10
One compressor for running same	533.00
One receiver for air storage	64.80
One steam capstan	495.00
Setting up and connecting above	185.40
Building 1-story cabin for sheltering machinery — material and labor	465.00
Total cost of tender ready for use	\$ 6,589.36
Type of float now in use, composed of 13 boats; cost, labor and material	\$ 1,140.00
Eight drills, E-24 Ingersoll-Sergeant	1,950.00
Steam hose, drill steel, iron pipe	365.00
Cost of float, equipped for drilling	\$ 3,455.00
Cost of tender	6,589.36
Cost of one drill unit	\$10,044.36

Three drill units were operated during the season of 1912, and it was found that one drill sharpener could keep steel in shape for the three units, each of which carried eight drills. Only

one tender, as described above, has been built for the work here, the other two units being furnished with steam by spare pieces from the plant. It was found that the greatest wear and deterioration in the drill units is in the float and the drills, it having been found necessary to rebore and overhaul a number of the drills and that two seasons' work is about all that the floats will stand.

The area drilled in 1911 extended from the upper end 2,500 ft. downstream. Estimated in place there were 35,136 cu. yd. of material to be removed in order to reduce this area to grade. When this area was dredged a great many high points were found, making it necessary to reblast a considerable portion of this channel, and suggesting the advisability of deeper and closer drilling. During this season 28,831 ft. of holes were put down, loosening up about 23,155 cu. yd. of material, costing as follows:

Actual field cost, including material, salaries, subsistence, etc.	\$13,299.59
Deterioration of plant on account of season's work	3,840.00
Overhead charges	664.98

Total cost	\$17,804.57
Cost per foot of hole617
Cost per cubic yard, loosened76

The closer spacing of the holes, 4 x 6 ft., in 1912, served to loosen up the material much better and the dredges were able to get "grade," with the exception of a small area which was drilled when the river was too high. During the 1912 season, 85,708 ft. of holes were drilled and blasted, loosening up 76,185 cu. yd. of material estimated in place, costing as follows:

Entire field cost, material, etc.	\$41,457.75
Estimated deterioration of plant	7,500.00
Overhead charges	2,072.88

Total cost	\$51,030.63
Cost per ft., drilled and blasted595
Cost per cu. yd., loosened669
Total amount of material loosened up in the two seasons, 99,566 cu. yd.	
Total amount of dynamite used, 75,450 lb.	\$12,855.36
Amount of dynamite per cu. yd., $\frac{1}{4}$ lb.	¢ .127

To prevent the holes from filling with gravel and silt, etc., the drilling was done through tubing or pipe, 3 or 4 in. in diameter. From three to five drill bits were used in putting down each hole, the first bit being 2½ in. in diameter, and the last 1¾ in. When the hole was down to a proper depth, a pipe that would exactly fit the top section of the hole was put in and the bit taken out and the hole loaded, the charge consisting of 80% gelatin dynamite, and varying from 6 to 10 sticks, according to the depth in the rock. The stick having the primer was placed about one-third of the way down from the

top, having from 2 to 3 sticks on top of it and 4 to 6 under it. The charge was firmly packed down in the bottom of the hole with wooden poles which fit very closely the section of the hole. When the loading was completed the hole was marked by a cane, which was firmly embedded in the charge, leaving the top of the cane about 6 in. above the surface of the water and the primer wire looped around the top of the cane. When all the holes were loaded the primers were all carefully connected so as to make three circuits, 24 holes to each circuit, leaving the end wires of the first and fourth line looped around the top of the cane so that they might be readily found and connected with the lead. The float was then dropped down from over the holes and a set of lead wires attached to each circuit. When these were connected (insulated tape being used for making all these connections) the float and tender were dropped back about 250 ft. below and the charges ignited by using three large batteries simultaneously.

While each of the batteries would fire all these charges on shore, 24 holes was about their limit under water. This method was usually successful in getting off all charges together when the river was at a stage below 3 ft., but above this stage the connections were often interfered with by the force of the current and running drift, etc., necessitating several reconnections with the lead wire in order to get off the charges, and it was frequently the case that the wires were broken or withdrawn from the caps, making it impracticable to fire the charges.

A Portable Drill Platform. (*Engineering and Contracting*, April 1, 1914.) A platform was constructed for use in drilling holes for anchorage bolts on Mississippi River at St. Louis, Mo. The details of this platform are shown in Fig. 174 and a view of the platform in place with the drill mounted and ready for use is shown in Fig. 175. It was composed of a concrete block with a section of 12-in. pipe imbedded in it and a timber platform fastened to the top of the pipe. The concrete block was 6 ft. square and 3 ft. thick, the pipe being imbedded in it for 2 ft. The pipe was 22 ft. long and as the bottom of it was 1 ft. above the bottom of the block this brought the top of the pipe 23 ft. above the river bottom when it rested on the bottom. It was braced to the concrete block by means of eight 1-in. reinforcing bars, the lower ends of which were cast in the block near its outer edges and the upper ends of which were clamped to the pipe by a heavy collar at a point about 4 ft. above the block. On top of the pipe was a standard flange and below it were two 6 in. x 8 in. timbers 6 ft. long running parallel to each other and at opposite sides of the pipe. These timbers were bolted together and bolts running down through the

chored with the stern up stream by means of two lines running to two concrete anchor blocks previously placed.

The drill platform was lifted by the derrick and lowered until the concrete block rested on the river bottom. When the concrete block rested firmly on the river bottom and the derrick had been unhooked, the drill, an Ingersoll D-24 machine was set up on the platform and drilling started.



Fig. 175. View of Portable Drill Platform with Drill Mounted and Ready for Operation.

The Removal of the Lytton Rocks, Brisbane River. The following account of the methods and costs of removal of the Lytton Rocks is compiled from a paper by M. E. A. Cullen in the *Proceedings of Institute of Civil Engineers*, vol. 142 (1900), p. 202. The rock was a dolorite dyke and was located at a point where the maximum speed of the current was 3 knots per hr. No drilling was attempted when the current speed was greater than 1 knot.

The drill boat was an old iron barge, 70 x 16 ft. It was equipped with two Ingersoll-Sargeant 4¼-in. percussive drills operated by steam at 55 to 60-lb. pressure. Each drill was mounted on a cage suspended from the jib of a 1-5 ton crane. The crane was on a wheeled platform on rails and the original intention was to keep the barge stationary and move the crane forward. This, however, was found inconvenient and it was necessary to move the barge forward after drilling a pair of holes. The drills were mounted 20 ft. apart, but the holes were spaced 3 to 5 ft. apart in rows 4 ft. apart.

The maximum depth of holes was 8 ft. which was 2 ft. below the required "grade." The drill rods were of octagonal 1.5-in. steel 24 to 35 ft. long, with 2.5 to 3-in. cross bits. The larger size bit was found to be better. Eight holes were fired by electricity at a time. They were charged with blasting gelatin, 3 lb. per hole. The gelatin and fuse were wrapped together with calico and lashed to 6-ft. lath for loading. During firing the barge was removed a distance of 70 ft. The overlying sand was previously removed by water jets or pumps. These were attended by a diver who was also employed in placing the charges.

The total number of holes drilled was 6,863; total length of hole, 39,187 ft.; best day's work, 240 ft.; quantity of rock removed, 27,310 cu. yd. place measure; blasting gelatin, 9,750 lb. (0.36 lb. per cu. yd.). The total cost of drilling and blasting, not including plant charges, was \$1.04 per cu. yd. The rock was well broken, 90% being in pieces weighing less than 80 lb. The maximum size was 400 lb. The rock was raised by a large bucket ladder dredge with ordinary buckets of 12.5 cu. ft. capacity. The greatest depth at which rock was removed was 13 ft.; the maximum's day's work was 800 tons; the number of days 163; average output per day, 250 cu. yd. (barge measure). The cost of dredging based on yearly averages, including docking and renewals, was 48 ct. per cu. yd. solid measure. The rock was transported as a rule six miles by 3 large steam hopper-barges. The cost of transportation was about 24 ct. per cu. yd.

The total cost including plant charges for drilling and blasting, was about \$2.00 per cu. yd. solid.

Drilling with a Pile Driver, Oconie River, Georgia. (Engi-

neering and Contracting, July 19, 1911.) The following data relate to methods and costs of drilling, blasting and removing rock at Carr Shoal, Oconie River, Georgia, as described in "Professional Memoirs" by Mr. L. H. Roberts. The work is worth noting because of the unusual method of drilling pursued, which was by driving a drill rod into the rock under the blows of a pile driver.

Three methods of drilling were used. When the water was too shallow to permit boats to work in it, hand drilling was sometimes resorted to. At other times an Ingersoll-Rand tripod drill was carried out on the rocks ahead of the plant and fed with steam. A considerable quantity of rock was also taken out by hand, loaded on a small barge and moved to one side. It is estimated that this preliminary hand work occupied one-third of the working time.

On any but the hardest rock a drill of 1½-in. octagon steel with a 4-in. taper point, working in a casing of 1½-in. pipe, was used. The lower end of the casing was drawn snugly around the drill. The upper end of the drill was fitted with a collar or shoulder, which caused the casing to penetrate the rock with the drill. The drill was driven a short distance below the required depth by means of an 1,800-lb. pile hammer, the drill was then taken out and the casing left in place. Dynamite was then loaded in the casing and the casing removed leaving the charge in place in the drill hole. When there was a hard layer of rock on top of the softer layer a 2-in. steel rod was driven through the hard layer, pulled up, and the smaller drill and casing sent down. A platform hanging from the leads of the pile driver provided a place for the men to stand when drilling and loading. About 90% were fired in one blast by a blasting battery.

The steam drill platform was mounted on the stem of the pile driver and the drilling was done through a casing of 6-in. pipe resting on the bottom. Holes were 1¼ to 2½ in. in diameter and were kept clear of sand by a water jet. As the last drill was pulled out a casing was slipped into the hole to keep out the sand and the powder was loaded through this. As the rock was usually covered with sand this method was very troublesome and slow.

Dredging was accomplished by the orange-peel bucket dredge Sapelo. (See Fig. 176.) This machine was 85 ft. long, 30 ft. beam, and drew 30 in. of water. It was equipped with a stiff leg derrick using a Lidgerwood swinging gear and bull wheel. The boom was 56 ft. long and the bucket covered a circle about 75 ft. in diameter. Rock 20 ft. ahead of the boat could be reached. The bucket was a four-bladed Haywood orange-peel bucket of 21 cu. ft. capacity. The machine would stand a speed

of 75 swings on a continuous run, but would only reach this speed in soft material or in very well broken rock.

The work was started Aug. 9 and completed in four months and 6 days.

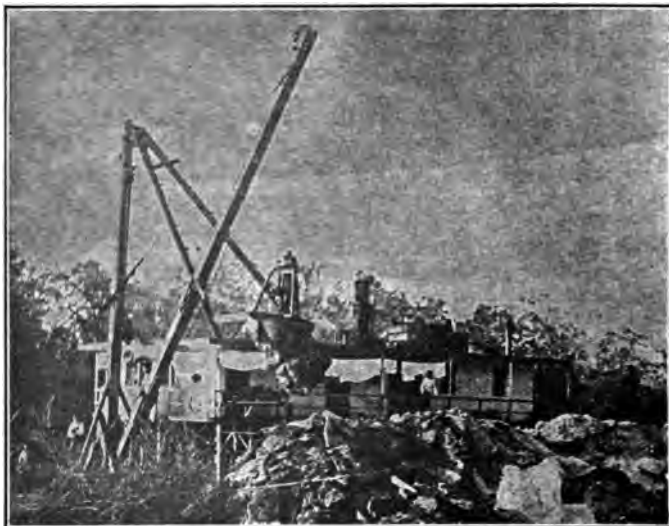

Fig. 176. U. S. Dredge Sapelo at Bells Ferry, Oconie River, Georgia.

The average size of the crew was ten men—foreman, two enginemen, cook, cabin boy, and five laborers; the number of laborers was increased or decreased as the nature of the work required.

The principal data of the work were as follows:

Dimensions of cut—		Ft.
Length		810
Width		80
Average depth		5
Yardage dredged—		Cu. yd.
Rock		5,146
Clay		2,292
Sand and gravel		130
Total		7,568
Blasting data—		
Number of holes		1,642
Number of blasts		139
Pounds of dynamite used		589

Time employed —	
Days actually worked	99
Days delay from high water	5
Other delays, days	½
Holidays	5½
Sundays	18
Total days	128

The total cost of the work was as follows:

	Per cu. yd.	
	Rock.	Earth.
Wages	\$.383	\$.072
Subsistence116	.022
Fuel and oil048	.009
Dynamite, caps, etc.152	.029
Maintenance of plant086	.016
Drayage of supplies009	.002
Total	\$.794	\$.150

It is estimated that the cost of removing 2,322 cu. yd. of clay, sand and gravel was 15 ct. per cu. yd., leaving the cost of removing 5,146 cu. yd. of rock as \$4,088.58, or 79.4 ct. per cu. yd. The cost of all excavation was 59 ct. per cu. yd.

Cost of a Channel in Basaltic Rocks at Melbourne. The following data have been compiled from a paper by Mr. Joseph Brady in the *Transactions Institute of Civil Engineers*, vol. 252 (1883), p. 74, relating to work in the river Yarra at Melbourne, Victoria. The work comprised the removal of a bar 150 ft. wide of hard basaltic rock, which was overlaid by bed of rough yellow clay 3 to 4 ft. thick. The desired depth was 19 ft. at low water. The work of drilling was performed by two working drills, with a third in reserve, which were operated by compressed air at 90 lb. pressure. Sixty-five drills, of 1½ in. square iron with steel bits of star shape 2⅞ in. in diameter, varying in length from 18 to 30 ft., were in use. The drills were kept sharp by one blacksmith. The drill machines were mounted on a floating stage composed of two 20-ton pontoon-punts, 3 ft. apart. On each side of the stage were rails carrying light travelling derricks. In each derrick a guide pole, 6 in. square, worked freely. On each guide pole was mounted a rock drill, adjustable at varying heights by a rack and pinion. When the drills were in use the guide poles rested on the river bottom, the stages rising and falling freely without affecting the guide posts.

The equipment comprised a 10-in. horizontal engine, a boiler, air compressor and receiver, diving dress, and a work shop. There was also another floating work shop for the cartridge maker, and a 40-ton flat pontoon with two 2-ton derrick cranes, steam operated, for lifting rock. A steam spoon dredge did the final dredging.

Holes of 3-in. diameter, 4 to 14 ft. deep, in rows of 7 in. 30

ft., 3 to 3½ ft. apart, were drilled. Each hole, after being drilled, was cleaned out with compressed air, and charged with 3 to 8 lb. of Noble's No. 1 dynamite. The holes were charged by a diver who prepared a set of seven holes in a few minutes. No tamping was used. The plant was hauled 35 ft. away, and the holes fired by batteries.

The divers who removed the rock worked in two parties in 4-hr. shifts. Operations were carried on day and night. Seven men worked in a shift. The rates of wages per day of 8 hr. were as follows:

Foreman	\$2.88
Engine drivers	2.12
Drillmen	1.92
Divers (when diving)	3.60
Divers (when working otherwise)	1.92
Blacksmiths	2.40
Strikers	1.68
Deckhands	1.68

The work occupied 3 yr. 4 mo. and cost, exclusive of plant, \$83,286. The plant cost \$17,266. The material removed included 22,191 cu. yd. of hard clay (blasted) and 20,087 cu. yd. of rock. The average cost was \$1.08 for clay and \$2.95 for rock per cu. yd., placed in barges. This cost is exclusive of interest on the plant investment. The number of holes drilled was 4,900 and they were each 3 in. in diameter. The dynamite used amounted to 22,132 lb. or slightly more than ½ lb. per cu. yd. of material removed.

A Hand Churn Drill on Subaqueous Work, Sydney. I am indebted to a paper by Mr. William Keeling in the *Transactions of Institute of Civil Engineers*, vol. 40, p. 138 (1874-5), for the following description and cost of removing rock in Sydney Harbour. The depth of water required was 15 ft. The material from its surface to a plane 12 ft. below water was blue clay and silt which was easily excavated by a dredge. The following 3 ft. was marl, a very hard and tenacious red sandstone, which, when exposed to the atmosphere, expanded and disintegrated rapidly.

A raft, 40 x 20 ft., was constructed. In the raft were holes 3 in. in diameter and 6 ft. apart with other holes centered between them. This raft was firmly anchored over the site. Wrought iron pipe passed through the holes and rested on the rock. A churn drill 1¼ in. in diameter and 21 ft. long, with a drill bit 2¼ in. wide, was worked up and down through this pipe by four men using handles keyed to the drill and adjustable for various heights. The work was very hard on the men and the progress naturally slow, hence a frame was erected and by means of levers attached to the drill, it was possible to operate the drill with two men while it was rotated by a third. Through this device progress was twice as fast. Holes in the

pipes allowed the sludge to escape. Two or three gangs worked at one time.

The holes were drilled 4 ft. 6 in. deep. Watertight cartridges, 2 ft. x 2½ in., containing 4 lb. of gun powder were charged in each hole and tamped with broken marl. The charges were fired by fuse. The objections to the use of gunpowder were: (1) It was necessary to bore 18 in. below the required depth; (2) the rock came out in large pieces difficult to handle; (3) the misfires, due to failure of fuse, were 15%; (4) this involved the boring of other holes; (5) and progress was slow due to fuse burning 5 to 10 min.

The cost of removing 10 cu. yd. from an area of 6 x 6 ft., and of placing the excavated material on shore was as follows:

Drilling 5 holes 22 ft. 6 in. at 12ct. per ft.	\$ 2.70
5 cartridges with fuse at 96ct.	4.80
Misfires, 15%	1.13
Dredging 10 cu. yd. at 36ct.	3.60
Interest on dredger and other plant80

Total, at \$1.30 per cu. yd.\$13.03

Holes were then drilled 3 ft. and 1 lb. of dynamite in calico 9 x 2½ in. was fired by electric battery. Very little tamping was used. The cost of removing 10 cu. yd. as above was:

Drilling 5 holes 15 ft. at 12ct.	\$1.80
Dynamite, 5 lb., at 52ct.	2.60
5 detonators and wire at 13ct.65
5 canvas bags at 2ct.10
Dredging 10 cu. yd. at 36ct.	3.60
Interest, etc.80

Total at 95 ½ct. per cu. yd.\$9.55

Drilling by Hand at Blyth Harbor, England. For the following description of the method and cost of drilling by hand in Blyth Harbor, England, I am indebted to a paper by Mr. William Kidd, in the *Transactions Institute of Civil Engineers*, 1885, p. 302. The position of the rock removed was 700 ft. long, 8 ft. wide at one end, and 88 ft. 6 in. wide at the upper end, with a maximum width of 139 ft. 6 in. It was 7,803 sq. yd. in extent and was removed to depth ranging from 0 to 16 ft., and averaging 14 ft. 5 in. The material was yellow sandstone, shale and clay with boulders and beds of quartzite.

The drilling was done by hand from rafts, 25 x 13 ft. in size. The drill holes were 2½ in. in diameter, and were driven by hand with drill of round iron (1¼ in.) with chisel bits 2¾ in. in width. To prevent sand from entering the holes and to facilitate loading, boring tubes 3 in. in diameter were driven into the ground. Four men operated each drill. The average speed was 3 ft. per hr., and the labor cost of drilling was 24 ct. per ft. The rock was removed in two lifts, the first to a depth of 9

ft. below water. Holes were spaced 6 ft. 3 in. apart, and the average depth driven was 10 ft. 10 in. below low water for the first lift and 6 ft. 6 in. below the first lift for the second lift.

The price of explosives was as follows: gunpowder, 9 ct.; dynamite, 39 ct.; and gelatin, 48 ct. per lb.; fuse, 1 ct. per lb. The blasting charge was contained in water tight tin cases, 2 in. in diameter, plugged with 2 in. wooden plugs, and fired with a detonator and fuse. There were few misfires except in frosty weather when the dynamite was apt to burn. No tamping was used.

A single-ladder, central-well dredge, 100 x 25 x 10 ft., with a 25 hp. engine (26 x 36 in.), and a 20 x 16 ft. boiler working at a pressure of 10 lb. per sq. in., loaded the material into hopper barges. These barges carried the spoil to sea some 3 miles away. The ladder, provided with buckets and "claws" was 60 ft. long, and reached a depth of 23 ft. In soft sand and mud this machine averaged 90 tons per hr., and in rock it averaged 6 tons per hr. for two weeks' work, including shifting and delays. The bucket held 2.8 cu. ft. The crew numbered 61. Three hoppers, each with a capacity of 120 tons, were employed.

Dredging was carried on night and day in 12-hr. shifts. The ridges and patches left by the dredge were removed by a diver. There were 4,500 holes ($2\frac{7}{8}$ -in.) for 24,500 cu. yd.

	Per cu. yd.
Drilling	\$.42
Blasting32
Drilling and blasting	\$.74
Dredging, labor only (incl. repairs)	\$.46
Dredging, materials (incl. repairs)26
Total dredging (excl. int. and dep.)	\$.72
Grand total	\$1.46

Explosives used:

Explosives used —	Lb.
Gunpowder	9,095
Nobel's No. 1 dynamite	6,050
Nobel's blasting gelatin	4,170
Tonite	1,400
Lithofracteur	200
Total	20,915
Av. price per lb.	27.6 ct.
Explosives per cu. yd. of rock853 lb.
Total explosive (not incl. gunpowder)	11,820 lb.
Av. price per lb. (exclusive of gunpowder)	41.8 ct.
Cost for explosives (total) per cu. yd.	32 ct.

Cost of Drilling by Hand at Freemantle Harbor, Australia.

In order to deepen the entrance to Freemantle Harbor, in West Australia, in coralline limestone and sandstone, the drilling was

done by hand. This was necessary because the work had to be started quickly and to obtain special plant from Europe would have caused delay. Floating craft could not be used because of the shallow depth of the water. The rock was soft enough for hand drilling and the drilling was therefore done by hand from stages. These consisted of light 30-ft. planks carried on four-footed trestles with ladder-shaped tops, permitting the planks to be raised or lowered. In two days 20,000 sq. ft. of this staging could be placed in position, and it could carry 120 to 160 men, drilling with regularity in 20 ft. and more of water. The holes were 8 to 12 ft. apart, according to the quality of the rock, and the charge consisted of 12 to 15 lb. of dynamite or gelignite, a ton of explosive sufficing for about 5,600 cu. yd. of rock blasted.

From the total cost and percentages given by Mr. C. S. R. Palmer, in *Transactions Institute of Civil Engineers*, vol. 184 (1911), p. 157, I have derived the following table of cost of drilling and blasting about 1,500,000 cu. yd. of rock:

	Per cu. yd.
Stages and other plant	\$.122
Placing stages046
Tugs, punts, pumping, etc.031
Stores, piping, drills, other tools046
Explosives and blasting122
Drilling369
Repairs to plant031
Totals	\$.767

Cost of Excavation, Eagle Harbor, Mich. The following facts have been abstracted from a report by Mr. L. Y. Schermerhorn: In 1877 a dredge was used for removing blasted rock in Eagle Harbor; 3,200 cu. yd. being dredged in 63 days (10-hr.) to a depth of 14 ft. The dredge scow was 65 ft. long, the dredge being an "Otis" with a 1 cu. yd. dipper. The rocks handled by the dredge dipper average less than 1 cu. ft. in size. Rocks of 1 cu. yd. or more were chained out. The rock was a trap and conglomerate, weighing 169.4 lb. per cu. ft.; and 1 cu. yd. of solid rock made 1.83 cu. yds. of loose rock in the scows. The rock dipped 30° to the north. The following table gives the data of three seasons' work:

Season.	No. of holes.	Ft. drilled.	Av. depth of hole, ft.	Av. dist. apart.	Bits sharpened.	Ft. drilled per hr.	Drill steel, lb.	Holes exploded.	Dynamite.	
									No. 1, lb.	No. 2, lb.
1875..	392	2,099	5.35	5.0	656	2.36	51	147	75	411
1876..	309	1,945	6.30	7.7	132	2.67	46	275	775	3,260
1877..	183	1,343	7.34	8.5	88	2.26	32	154	600	1,899
Total.	...	5,387	876	...	123	...	1,459	5,999

Most of the drilling was done from a large platform; but for drilling boulders a tripod platform was used, on which the drill was mounted. Drill holes were plugged with wooden plugs, but storms and ice caused the loss of nearly two-thirds of the holes drilled the first season (1875). One-half the cost of drilling was chargeable to the first 2 ft. of the hole; that is, up to the point where the drill pipe entered the hole, protecting it from further filling up with sand. During the last season (1877) the holes were drilled 20 ft. below water surface, or about $4\frac{1}{2}$ ft. below the bottom of the intended excavation; but a greater depth would have made the dredging easier by breaking up the rock better.

No. 1 dynamite broke the rock up well for a small area around the hole; but No. 2 broke the rock up better for a greater area. A mixed charge of No. 1 and No. 2 proved the most effective.

The following are the data of dredging: June 26 to Sept. 6, 63 days; days worked, 47; average hours worked per day, $12\frac{1}{4}$; repairs made during good weather, 83 hr.; repairs made during bad weather, 46 hr.; rock dredged per hr., 5.55 cu. yd.; rock dredged (place measure), 3,000 cu. yd.; boulders dredged, 200 cu. yd.; large rock chained out by divers, 150 cu. yd.; average depth of solid rock excavated, 2.6 ft.; maximum depth of rock, 5.0 ft.; area excavated, 35,000 sq. ft.

Cost of Excavating Black Tom Reef, N. Y. In Farrow's Military Encyclopedia are given some valuable data on submarine rock excavation, from which I have abstracted the following relating to the excavation of Black Tom Reef in New York Harbor. Mr. W. L. Saunders was in charge of this work and designed apparatus which marked an epoch in submarine drilling and blasting. The work was begun May 2, 1881, and was completed in 344 actual working days (35 days were lost by storms and 26 in equipping scow).

The drilling plant consisted of three 5-in. percussive Ingersoll drills mounted on a platform supported by spuds; a scow anchored alongside carried the boiler that furnished steam to the drills. The longest drill steel used was 28 ft. long, and the shortest, 16 ft.; the starting bit was $3\frac{3}{4}$ in.; the finishing bit, $2\frac{1}{2}$ in.; and 9 ft. of hole were drilled on an average with each bit before sharpening. The drilling shift was 10 hr. long, one shift a day; and 20.8 ft. of hole per drill per shift was the average drilled in the mica schist, not including the penetration of some 6 ft. of sand and gravel overlying the rock.

Mr. Saunders invented an "ejector" which is a pipe surrounding the drill steel and through which water is forced to wash away the gravel and sand. There were 1,736 holes drilled, 1,629 charged and 1,542 blasted; the average depth in rock

being 10.17 ft. The distance between holes was 4 ft.; the area excavated, 32,100 sq. ft., and the rock removed, 5,136 cu. yds., place measure. The dynamite was 75%, of which 20,461 lb. were used; exploders, 1,844; drill steel, 395 lb.; connecting wire, 77 lb.; coal, 200 tons at \$4.14; hose, \$491; water, \$500. For each cubic yard 3.44 ft. of hole were drilled, and 3.98 lb. of dynamite used. The cost of the plant was:

Barge and equipment	\$ 6,640
Two drill floats	9,082
Alterations, machinery, etc.	5,663
Total	\$21,385

The cost of drilling and blasting was:

	Per cu. yd.
3.98 lb. 75% dynamite	\$1.84
1.22 oz. steel02
Coal and water25
Labor (payroll, \$26.76 per day) ..	1.79
Repairs, plant31
Repairs, drills01
Repairs, ejector pipes05
Repairs, hose09
Wire and tape01
Total	\$4.37

To this must be added the \$1.95 per cu. yd. paid for dredging by contract, making a total of \$6.32.

Drilling and Dredging Way's Reef, N. Y. Harbor. Way's Reef, New York Harbor, was removed in 1874. The crew was 35 men, consisting of 1 draftsman, 2 divers, 3 carpenters, 1 engineman, 8 drillers, 1 blaster, 1 blacksmith, 2 blacksmith helpers, 12 sailors, 2 firemen, 1 timekeeper and 1 tide gage keeper. This crew worked two shifts on the U. S. steam drilling scow. At first the starting bits were 3½-in., but later it was found that by using a 5½-in. bit more explosive could be placed in a hole resulting in breaking the rock up much better, even with comparatively wide spacing of the holes. The average depth of drill hole was 8.13 ft., but only 6½ ft. of hole were averaged per drill per 8-hr. shift. About 3,030 cu. yd. of mica-schist were excavated, 15,308 lb. of nitroglycerin being used. The cost of dredging and dumping the rock was \$4.29 per cu. yd., the dredge averaging 35 cu. yd. per day. The total cost of this excavation was \$18.26 per cu. yd. The work was done by day labor for the Government, and at a time when subaqueous drilling was an art little understood.

Drilling in San Francisco Harbor. The following is an abstract from *Engineering Record*, May 26, 1900: In San Francisco Harbor ledges of metamorphic sandstone were drilled from a revolving platform. The platform, 25 x 160 ft., is made of four lines of longitudinal stringers of 3 x 12-in. timbers bolted

together. These stringers rest on 8 x 10-in. floor beams that are 20 ft. c. to c., and queen-post trussed. Through the center of the platform rises a mast 2 ft. square and 68 ft. high, made of four pieces of 12 x 12-in. bolted together and dressed to a diameter of 18 in. for the upper 15 ft. The top of the mast is guyed by four wire cables to anchors. One block of a tackle is clamped to the upper end of each guy; the other block is attached to the top of the mast, and enables the guys to be tightened or adjusted readily. Fifteen feet below the top of the mast there is fixed to it a collar with a channel in its upper surface, in which there are steel balls for the bearings of a revolving collar above, to which are attached 18 guys (1-in.), or supports, one to each end of each of the nine floor beams. These guys are adjusted by long turn-buckles at the bottom. Two steam drills and one well driller are installed on the platform and operate 10-in. bits. The holes are cased with 10-in. sheet iron pipe. Steam boilers are located on a barge and deliver steam through ball and socket pipe.

Drilling and Dredging Boulders, Wood's Hole, Mass. The following is an abstract from *Engineering Record*, Jan. 13, 1900: At Wood's Hole, Mass., large boulders were encountered in dredging and were drilled from a platform (10 x 25 ft.) suspended from the dipper boom by a tackle at each corner. Ordinarily the platform is held by clamps which slide on vertical clamp timbers on the bow of the dredge. If it is desired to swing the platform around one end as a center, it is clamped to one guide only, which is in the middle or at one corner. A slot to drill through runs from end to end of the platform.

A 3½-in. pipe has at one end an 18-in. ring 6 in. deep with the annular space cast full of babbitt; and this is set vertically in the slot of the platform. The loaded end of the pipe is set on the highest point of a boulder, and, even against the strongest tides, is held in position by its weight and by guys from the bottom to the platform. A Rand drill is placed over the pipe and its 2¼-in. bit inserted in it. The Rand drill is lowered by tackle when the limit of its feed is reached. For charging the bit is replaced with a 2-in. loading pipe and a 1-in. cartridge is inserted and fired without moving the dredge. An ordinary day's work with a 7-yd. dipper dredge has been 126 cu. yd. of earth and 7½ cu. yd. of rock.

Cost of Undermining Flood Rock, Hell Gate, N. Y. This work is described in detail in Farrow's *Military Encyclopedia*. and while the method of undermining is not likely to be used again for harbor deepening, there are certain features that merit attention. Flood Rock was a 9-acre obstruction in New York Harbor, and under the direction of Gen. John Newton it was

finally removed in 1885. Two shafts were sunk and 10 x 10-ft. drifts or galleries were run at right angles to one another, leaving pillars of rock 15 ft. square supporting a rock roof averaging 19 ft. thick, although in places it was only 10 ft. thick. In driving the drifts very small charges of rackarock were fired, one hole at a time, to insure safety from flooding through unexpected seams in the mica schist rock. Any seams encountered were plugged with cement. In driving the 10 x 10-ft. drifts, 6 lb. of rackarock and 12 ft. of drill hole were required per cubic yard. The total drifting was 21,669 ft., or 80,232 cu. yd., requiring 480,000 lb. of explosive.

The pillars and roof (270,717 cu. yd.) were drilled and charged with 1.04 lb. of explosive per cu. yd. of rock, requiring 0.42 ft. of drill holes per cubic yard. The final charge in the pillars and roof was 240,400 lb. of rackarock and 43,300 lb. of No. 1 dynamite, in 11,789 drill holes in the roof and 772 drill holes in the pillars, or a total of 113,120 ft. of drill holes.

The cost of the work and explosives required in preparing for the final blast was \$2.69 per cu. yd. of total excavation; and the rackarock used in the final blast cost \$106,510. The loading of the final charge (283,730 lb.) of explosives was done by 20 men working 8 to 12 hr. a day for 70 days. Experiments had shown that a 10-lb. charge of No. 1 dynamite under water would explode another charge in a copper cartridge 27 ft. away, so that no electric connecting wires were needed between drill holes. The rackarock was loaded in thin (.005 in.) copper cartridges, which were soldered with a solder that was melted with wet steam. The main charge in each hole was rackarock, but the last cartridge in each hole was No. 1 dynamite, which was allowed to project 6 in. outside of the hole. Every 25 ft. apart along the drifts were placed cartridges (2½ x 24 in.) of No. 1 dynamite packed solid in a thin copper shell; and directly above each of these cartridges was a rigid brass cartridge (2 x 8 in.) containing No. 1 dynamite packed loosely and an electric exploder. The mine was flooded with water and fired. There was no loud report and the concussion was comparatively slight.

A contract was let for dredging the rock at \$3.19 per cu. yd.; but pending the award of the contract a derrick scow was used and removed 15 to 30 tons daily at a cost slightly less than the subsequent contract price. Large blocks were chained by divers. Later the contractors raised 120 tons a day, using two large grapple dredges. It is apparent from these meagre data that the rock (gneiss) was broken in large chunks which were dredged with great difficulty.

Cost of Removing Rock at Henderson's Point, Portsmouth Navy Yard, N. H. Mr. O. A. Foster, Superintendent of the

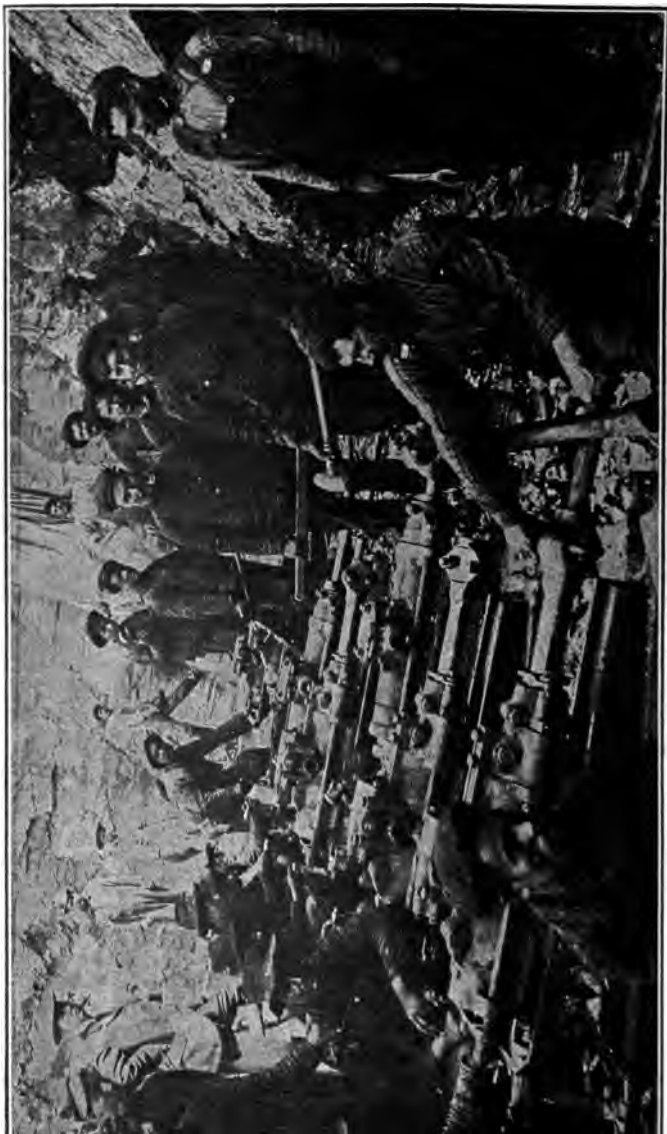

Fig. 177. Ingersoll-Sergeant Rock Drills Submarine Type) Drilling Blast Holes 50 to 70 ft. in Depth at Henderson's Point, Portsmouth, N. H.

Massachusetts Contracting Co., gives the following information concerning the removal of a point of rock jutting out into the river at Portsmouth, N. H. This point was a ledge of trap rock 400 ft. wide at the base and extending 300 ft. into the river, with an area excavated to a depth of 35 ft. below low water of about 3 acres. A cofferdam was built and the rock within excavated. This left a rim of rock 35,000 cu. yd. in volume and the intention was to run a series of small tunnels in this rim. The seamy and rotten nature of the rock discouraged this attempt and so "lift" holes were drilled from the bottom of the cofferdam excavation almost horizontally (slope 1 in 10) under the rock. (See Fig. 177). These holes were remarkably long, being from 50 to 79 ft. long. They were driven 5 ft. apart in a single row with 5½-in. submarine drills. The holes started 1 ft. below the required grade. Eight Ingersoll-Sergeant H-9 (5½ x 8-in.) drills were used. Holes were 6 in. at starting and the deepest holes were 2 in. in diameter at the bottom. The number of holes was 210 and it averaged 60 hr. (3 days) to drill each hole. In addition, a number of vertical holes were drilled just inside the cofferdam and a number of holes, 10 ft. apart, were bored with earth augers in the clay core of the cofferdam. These were charged with 30 lb. of dynamite per hole.

In all 38 tons of dynamite (about half of 60% and half 75% grade) were used or a little over 2 lb. per cu. yd. Nine hundred electric exploders divided into 45 groups of 20 each were fired by a current of 110 volts, 75 amperes.

The Lobnitz Rock Breaker. A typical machine of this kind is illustrated in Fig. 179. These rock cutters crush rock without the use of explosives. They are furnished with a cutting tool which consists of a heavy chisel of steel weighing 6 tons or more, usually 10 to 15 tons. This chisel is fitted with a hard cutting point by means of which the rock is broken. The cutter is allowed to fall by its own weight on to the cleaned surface of the rock. With a drop of from 6 to 10 ft. under usual conditions, the cutter forces its way into the rock, partly by breaking it and partly by pulverizing it. The whole force of impact is concentrated on a very small surface. The cutter delivers repeated blows on the same spot until it has penetrated about 3 ft. If the thickness of rock to be removed is more than 3 ft. it is best to take it out in lifts of not more than 3 ft. each, dredging each lift before breaking up the next layer. As a rule the distance between striking points is about 3 ft., although this depends on the nature of the rock and other conditioning factors. The barge is moved and reanchored or removed each time a new point is attacked. In fairly hard rock each blow breaks about 2 cu. ft. of rock. As a single cutter

delivers about 150 blows per hr. about 10 cu. yd. per working hour is an average output of a single cutter. The output of a double-cutter machine is about one-half more than that of a single-cutter.

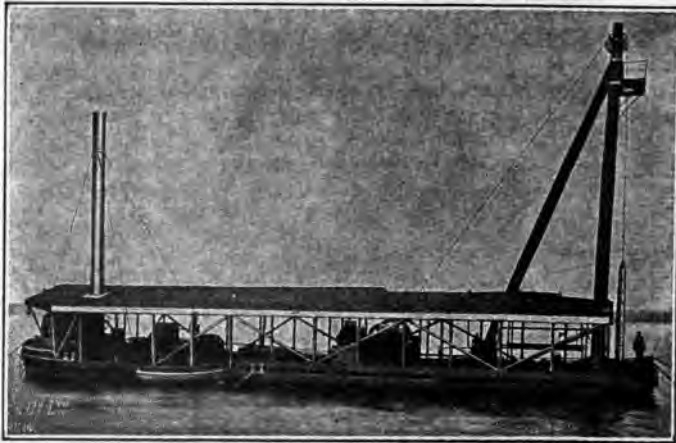

Fig. 179. A Lobnitz Rock Breaker.

A crew of four men is required on a barge equipped with one cutter and six men on a barge with two cutters. The coal consumption averages about 1 ton per day of 10 working hours for one cutter and 1.5 tons for two cutters. The consumption of fresh water is about five times the weight of coal or for a single cutter about 1,200 gallons (U. S.) and for a double cutter about 1,800 gallons.

This method of breaking rock is advantageous because of its freedom from the danger and inconvenience of explosives, and because of the small size of the pieces into which the rock breaks. Its use is limited, however, to soft or friable rock, and it is economical in certain situations only. The system is not suited to work in rough water or exposed situations, as the cutter must strike each successive blow on exactly the same point. One particular disadvantage is the necessity of removing the rock in shallow lifts.

On the Trollhattan Canal in Sweden, a Lobnitz rock cutter worked satisfactorily in horizontal beds of schistose rock, cutting about 2 cu. meters per hr. to depths of 8 to 11 in. In hard granite, however, the cutter rebounded without making any im-

pression on the rock. On ground which sloped more than 1 in 5 the cutter slid along and struck the vessel with such force as almost to wreck it. The rock cutter was therefore abandoned and, after unsuccessful attempts at blasting rock by exploding dynamite on its surface, a drilling platform equipped with Ingersoll Eclipse drills was successfully used to complete the work.

Rock breakers may be successfully used in shales, sandstones and similar soft rocks where tidal and other conditions permit the proper operation of the ram, whereas drilling and blasting may be used in any kind of rock regardless of the thickness to be removed and almost without regard to the conditions caused by strong currents, rough water, etc. At the Iron Gate of the Danube depths of rock of 1.64 ft. were allotted to rock breakers and greater thicknesses to drilling and blasting devices.

The Lobnitz Cutting Point. (*Engineering and Contracting*, Dec. 18, 1907.) The practicability of the whole tool depends on the strength of a steel point about 30 in. long, fitted into the bottom of the projectile shaft. The inside core must be very hard; the outside tough but soft. In this way the point wears away on the sides where the iron is soft, exposing the point itself to the harder material. Thus no matter how much wear occurs, the point itself always keeps sharp. The maintenance of this sharpness is particularly important in order that the impact may be concentrated on a small surface, thus shattering more effectively. In soft abrasive material, such as sandstone, a particularly hard quality of steel may be profitably employed. A soft and tough steel is in use in various places where the rock is exceedingly refractory. But in general it has been found that the hard core point meets the demand of both classes of rock. The barge must be quite stationary so that the blows center all on the same spot, otherwise there is brought a leverage strain on the point and sometimes on the wellway. In the very hard limestone rock at Buffalo the cutter let fall from the full height bounds away from 6 to 9 in. on the first impact. A reduced drop for the first few blows is necessary to start the hole, so that the shock may not be too great on the point.

The normal life of a point in the very abrasive rock on the Manchester Canal in England has been about one month, night and day work. When worn to a 9-in. face a point was replaced. The longest life was 17 weeks. At Tranmere, Liverpool, on rather harder rock than at Manchester it lasted five to six weeks. At Blyth, where the rock, mud and clay over rock-post sandstone, is harder but less abrasive, points have lasted two to three months with only 1 in. wear. At this place about 1,400 cu. yd. per week was the average output with 15-ton cutter, night and day work.

At Fort Edward, New York, in shale, points have lasted four months.

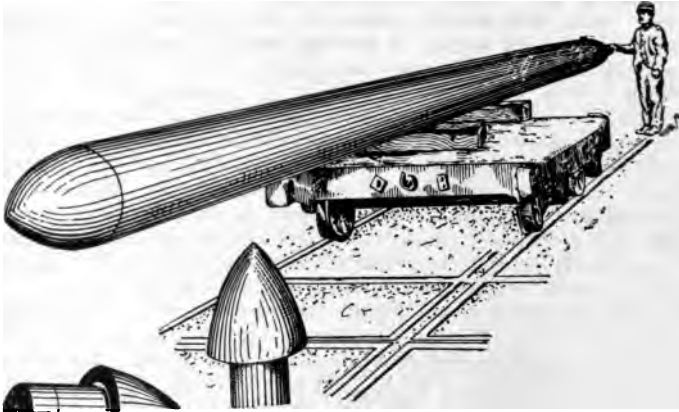

Fig. 180. Projectile or Cutter Used with Lobnitz Rock Cutter.

Speed of Lobnitz Cutting. The Lobnitz rock breaker used in deepening the Suez Canal was equipped with two cutters 44 ft. $7\frac{1}{2}$ in. long, each weighing 13 tons. The machine was capable of delivering 132 effective blows per hour, but, owing to the delays in moving the breaker barge out of the way of vessels, only 83 blows were averaged per hour. The thickness of the rock excavated and broken up by the breaker was 2 ft. $7\frac{1}{2}$ in. It required 5.4 blows to break up a cubic yard. This meant a little more than 15 cu. yd. per hour, or 150 cu. yd. of rock broken up to be handled per 10-hr. day. The rock in the Suez Canal consists of "limestone more or less hard, calcareous or silicious agglomerates, generally containing shells, calcareous tufa of a red color, gypsum and alabaster." In building the canal this rock was excavated out of water.

On the rock excavation under water at Blyth, England, a breaker weighing 15 tons was used. The rock was a sandstone variable in character from shale to hard and tough sandstone. It was found that a fall of 8 ft. gave a penetration of 3 ft into the rock with the breaker, in from 8 to 9 blows. This depth allowed the dredge to excavate the rock to a depth of 2 ft. 6 in. After considerable experimenting it was found that blows struck $4\frac{1}{2}$ ft. apart were close enough to break up either the hard or soft rock. Working day and night, the average yardage broken up per week was 908. This is computed from records

kept for six months. The quantity of rock broken is ascertained by the number and depths of the penetrations of the ram in a given time, which are recorded, and, after dredging, the amount of rock removed is checked by soundings.

At Blyth 150,000 cu. yd. of rock had been excavated by drilling and blasting before the Lobnitz breakers were installed. From the records kept, a comparison of the costs of the two methods has been possible. It has been found that the cost per cu. yd. has been about one-third less when using the breaker than when drilling and blasting. Not only has a saving been effected in breaking up the rock, but the efficiency of the dredge has been increased by the rock being in better shape for the dredge to handle.

The results on the Manchester Ship Canal according to the Chief Engineer, W. Henry Hunter, were as follows:

"Manchester Ship Canal; deepening from 26 ft. to 28 ft.; Lobnitz rock cutter No. 1.

"Average quantity (over a period of ten months) of rock broken up, per month, 6,403 cu. yd.

"Minimum quantity of rock broken per month, 5,622 cu. yd.

"Maximum quantity of rock broken per month, 10,160 cu. yd.

"The rate of advance of the rock cutter averages 36 ft. per diem, the bottom width of the canal being 120 ft."

The work is in sandstone of various degrees of hardness and a bank of rock 2 ft. in thickness had to be removed to increase ruling depth of the canal from 26 to 28 ft.

The results on other work are given in subsequent paragraph.

Operations with Lobnitz Rock Breakers on the Suez Canal.
In the *Transactions Institute of Civil Engineers* are several papers relating to the work of rock removal on the Suez Canal and experiments preceding the actual rock removal.

Before actual operations were begun an experiment was made on land. A steel-pointed rock-cutter weighing 2 tons, was raised by a steam-wind on a frame, like a pile-engine running on rails. The fall was 18 ft. and more than 4 cu. ft. of hard rock was dislodged, on the average, per blow. The first blow, with a fall of 3 ft., made an almost imperceptible crack, the second and third blows opened the crack 5 ft. long by 3 to 4 ft. deep, and at the next blow the wedge-shaped point generally entered the crack and split off the piece of rock.

A vessel (180 ft. long, 40 ft. broad and 12 ft. deep) was equipped with 4 rams each weighing 4 tons, and elevating bucket dredging machinery for use on the Suez Canal. This machine worked successfully and after many experiments and resulting improvements, was used generally in the work of widening the channel.

Mr. Lobnitz gives the cost of 16 days' work in variable tough conglomerate in beds of unstratified hard rock, varying from 5 to 10 ft. thick, with clay strata below, as follows:

Details of Expenditure of 16 Days at Chalouf.

Crew (23 men) at \$2.76 per hr., 140 hr.	\$386.40
Coal at \$7.20 per ton, 300 lb. per hr., 140 hr.	151.20
Oil and stores	42.24
Fresh water, 16 days at \$2.52	40.32
Upkeep, sundries, etc.,	8.16
Total for 1,000 cu. yd. at 63ct.	<u>\$628.32</u>

In the opinion of Mr. Lobnitz, the cost including repairs, but not including depreciation, interest and insurance, would be about \$1.20 per cu. yd. for crushing and loading rock aboard barges but not transporting it to dump.

Mr. Quellenec gives the cost of breaking up the rock in 20-in. layers during the year 1884 as \$1.75 per cu. yd. He gives the following account of subsequent work.

The rock met with in the bed of the Suez Canal consists of more or less hard calcareous or siliceous agglomerates, calcareous tufa, gypsum and alabaster. Some of these beds are very hard. When, in 1897, it was decided to deepen the canal to 31 ft., an investigation of the method of extracting the rock by mining and explosives proved that this system could not compare in economy with rock cutters. Moreover, the experience gained with the small rams of 3½ tons, and also with 5-ton rams, furnished an assurance that the employment of heavier rams would solve the problem in a satisfactory manner. Besides, in the special case of the Suez Canal the use of explosives is subject to numerous inconveniences from which rock cutters on floating barges are exempt, especially with regard to the obligation of being drawn to one side for the passage of vessels. With rock cutters also the bottom is levelled off in a fairly regular manner; whereas with explosives it is necessary to remove a large quantity of rock below the intended level.

The apparatus finally selected and used consisted of two cutters of cast steel 44 ft. 7½ in. long, each weighing 13 tons, the cutters having renewable points of chrome steel. The fall of the ram varied between 5 and 10 ft. The average thickness of the bed of rock shattered was 2 ft. 7½ in., and the number of blows required for shattering a cubic meter varied from 1 to 40, the average being 5.4 blows per cubic yard of rock broken up. The cost including repairs and an allowance for depreciation, varied from 4.52 ct. to \$1.81 per cu. yd., the average being 32 ct. Additional to this was the cost of raising the rock by dredgers and carrying it away.

Cost by Two Methods at Blyth, England. For the following data, relative to the cost of removing hard calcareous sandstone

rock with thin layers of slate and coal, at Blyth, I am indebted to a paper by Mr. G. D. McGlashan in the *Transactions Institute of Civil Engineers*, 1906-7, Vol. 170, p. 33.

Lobnitz rock-breakers were used and the boats were of steel construction, 100 x 28 x 8 ft., on which rested the tripod legs supporting the ram or chisel. The ram was operated by means of a wide rope led over a sheave at the top of the tripod to a winch. Each ram weighed about 15 tons. The spacing of striking spots was 4.5 ft. The average height of the drop was 8 ft., and the average total penetration of the chisel into the rock was 3 ft. The average depth dredged was 2.5 ft. Blows were struck at the rate of 4 per min. and it required from 5 to 15 blows (average 8) to penetrate 3 ft. The size of the broken rock averaged $\frac{1}{4}$ cu. ft. The life of the pointed ram was 100 working hr., and the life of the hoisting rope (6 strands on hemp core; 5 in. x 167 ft.) was 405 working hr.

The length of a shift was 12 hr. and there were 5.5 shifts per week per crew or 11 shifts per week. The coal consumption was 4,900 lb. per 24 hr. and the amount of water used was 17,000 gal. per week. The wages of the crew were as follows:

	Per week.
2 skippers at \$10.56	\$21.12
2 hoisting winchmen at \$9.60	19.20
2 maneuvering, at \$8.16	16.32
2 stokers at \$8.16	16.32
Total for 2 shifts per week	\$72.96

The following is a record of the performance during a period of 27 weeks:

Delays, per cent. of total time	54.3
Actual working per cent. of total time	45.7
Total	100.0
Wages of crew, towage, supervisor and proportion of water and coal expense	\$2,083
Coal (27 tons per 24 hr.)	665
Water at 28ct. per 1,000 gal.	98
Stores	84
Repairs, renewals	1,173
Total for 27 weeks	\$4,103
Cost per cu. yd. for 24,535 cu. yd., 16.7ct.	
Cost of rock-breaker and ram, \$32,640.	
Interest at 4%	\$1,305
Depreciation at 2½%	816
Insurance at 2%	653
Total for 27 weeks	\$2,774
Cost per cu. yd.	11.3 ct.
Grand total per cu. yd.	28.0 ct.

Compare with this the cost by drills mounted on a barge on this same work. These drills, 6 in number, were worked by hand, assisted by ropes attached to the drill cross-heads and led

over sheaves at the top of a derrick to drums upon a long shaft driven by a winch. The winch was kept going continuously and the lifting and releasing of the drills were effected by tightening and slackening two or three turns of the rope around each drum. The cost of drilling and blasting was 72 ct. per cu. yd.

Total Comparative Costs of Two Methods.

Item.	Lobnitz breaker.	Drop drills.
Drilling and blasting	\$.280	\$.72
Dredging rock670	.76
	\$.950	\$ 1.48
Total cost	\$.950	\$ 1.48

Comparative Cost by a Drill Barge and a Lobnitz Rock Breaker. From an article entitled "Equipment and Performance of the British Columbia Dredging Fleet" in *Engineering Record*, Aug. 23, 1913, I have compiled the following data relative to the operation of a drill barge and a rock-breaker.

The Lobnitz rock breaker, as purchased from the makers in England in 1910, was arranged for mooring by six cables running to anchors or mooring on shore. After trial in British Columbia, this method was found wholly impracticable because of the difficulty of getting back to the same working position, after the cables had been lowered to permit the passage of shipping and because of the large proportion of time lost in manipulating the cables. It was also found almost impossible to hold the vessel steady by this means. Extensive remodeling was therefore resorted to, and three 70-ft. spuds were attached, two at the bow and one at the stern, the drilling well being removed from the center of the machine to a position between the two forward spuds. This remodeling cost about \$5,000 but thereafter operations were fairly satisfactory and the time lost lowering cables and shifting with the tide while vessels passed by was entirely eliminated.

The rock breaker is equipped with two cutters or chisels suitable for different working depths. The larger of the two, weighing 20 tons, is designed for use in depths up to 40 ft. Each chisel has a detachable projectile steel tip made up with a hard core down the center so as to maintain a fairly sharp point as the tip wears. Several photographs were taken of the cutter in this position in the course of a study of causes for cable breakage. At first the cable broke very frequently and always close to the head of the cutter.

Drilling Scow. The drilling plant consists of a four-spud scow in which drilling wells are placed on 18-in. centers. A carriage operated lengthwise on the scow is provided with a 5-in. Ingersoll-Sergeant drill, which can be moved laterally on the carriage. The method of operating the plant is to tow the scow

to the point where drilling is required, and raise it on the spuds until above high-water level (Fig. 181). Holes can then be sunk through any or all of the drilling wells up to the depth of 35 ft. below the floor of the scow.

Powder is placed by means of tubes passing through the drilling wells, and when all charges are ready the scow is lowered until it can be towed away, after which the charges are fired simultaneously. It has been found most satisfactory to have the boiler for supplying steam to the drill, and in fact all auxiliary equipment, on a small scow floating alongside. Thus the entire floor space of the drilling platform is free from incumbrance.

Cost by Rock Breakers and Drill Boat:

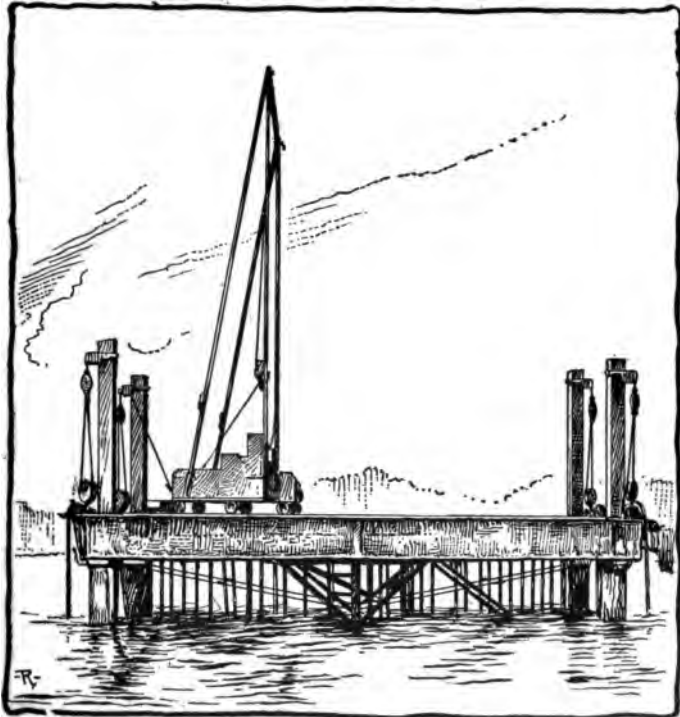

Fig. 181. Submarine Drilling Scow.

ft. per min., and allowed to fall a maximum distance of 18 ft. The cutter can deliver an average of over 70 blows per hour with the 2 rams.

Two shifts of 12 hr. are worked, 9 men per shift. Holes are spaced 2 ft. 6 in. x 6 ft. The rams fall one at a time. About 20 to 30 blows, with a fall of 9 ft., are required to drive the point 3 ft. into the rock.

The Drilling Float. This machine is illustrated in Fig. 182. It is a non-propelling barge. Steam power operates the drums around which a rope passes. This rope is tightened or loosened

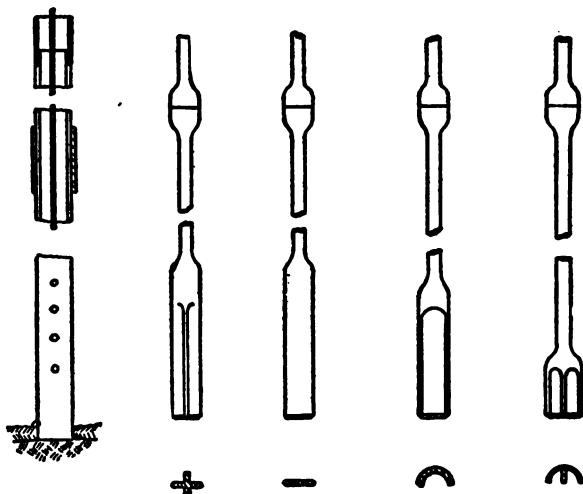

Fig. 183. Details of Tube and Chisels.

on the drum by a man. The rope passes over 7.5 in. pulleys, and to the drills which it raises or lowers. The drills are of 1-in. square iron in 10-ft. lengths of the cross-section shown in Fig. 183. These drills are worked inside 3-in. diameter iron tubes resting on the sea-bottom. The sludge escapes from the tubes through a number of $\frac{1}{2}$ -in. diameter holes. The rotation of the drills is regulated by a second man who turns the rod slightly when it rises as high as he can reach and then assists its descent by throwing his weight on it as the other man slacks the drilling cable.

The crew consists of 1 foreman, 1 engine driver, 1 fireman and 23 laborers. This float works only on day shifts. As the Lobnitz rock-cutter cannot break rock within 12 ft. of a wharf

face, all rock within that limit has necessarily to be blasted.

Noble's blasting gelatin is used exclusively to charge holes, the following table giving value of explosives:

	Approx. relative values.
Blasting powder (common)	40
Kieselguhr dynamite	100
Guncotton	100
Gelignite	110
Gelatin dynamite	125
Blasting gelatin	150

A charge consists of a parcel of blasting gelatin containing within it a detonator attached to the exploding wire. The charge is gently pushed home with a long wooden rod without tamping, as the pressure of the 20 to 30 ft. of water is considered sufficient to render this unnecessary.

The detonators are of the usual low-tension type with two

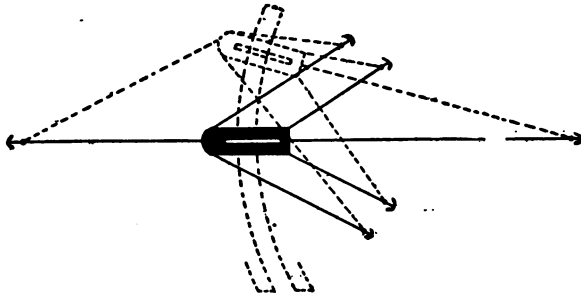

Fig. 184. Method of Working Stern Wheel Dredger.

short wires attached; one of these is connected to the firing cable and the other is unattached and free in the water, which acts as a conductor for the completion of the electric circuit. When all the holes have been charged the float is drawn off to a distance of about 40 ft. and the charges are exploded one by one.

The ordinary rule at Malta is to use 0.8 lb. of blasting gelatin for each charge, the hole being drilled 4 ft. 6 in. deep and the charge fired 6 in. from the bottom. For any other depth of borehole the charge is taken as proportioned to the cube of the depth below the rock-surface. Lighter charges are used close to wharves or buildings of doubtful stability.

Dredging Craft. The large dredge is 188 ft. long, 38 ft. beam, with a loaded draft of 12 ft. The buckets can dredge to a depth of 46 ft. 6 in. The fully loaded capacity is 600 tons of mud.

The dredged material may be discharged by the buckets either into the ship's hoppers or into hopper barges alongside, and

water may be pumped on the chutes to facilitate the discharge of material.

Two 12-hr. shifts are worked and each crew consists of 19 men, 3 English and 16 Maltese. A crew is composed of 1 master, 1 mate, 1 first and 1 second engineer, 1 ladderman, 4 firemen, 2 winchmen and 8 deck hands.

The usual method of working the dredge is shown in Fig. 184.

With the exception of a few weeks the "St. Dunstan" has been employed continuously as a hopper-dredger, taking her own spoil to sea, and not as a stationary dredge. The vessel is docked, cleaned and put in repair once each year.

With a side swell the dredger rolls so badly that in heavy weather it cannot proceed to sea. The time lost in Sundays, holidays and meal hours is 35.4% of the whole. Actual dredging consumes 29.7% of the whole; transporting, depositing and returning, 7.1%; dropping and picking up moorings, 3.2%; shifting anchors and other moorings, 3.4%; stopped by bad weather, 3.1%; miscellaneous petty losses of time, 4.1%, and repairs, 14%.

To obtain the foregoing percentages a study was made of the 52 weeks of 7 days of 24 hr. each, 8,736 hr. The dredger brought up 199,644 cu. yd. of mud or sand and 93,376 cu. yd. of rock, a total of 293,020 cu. yd. The material per hour was estimated by multiplying 8,736 hr. by 29.7% (the time spent in actual dredging) and dividing the total yardage by the result, thus getting 113 cu. yd. per hr.

These measurements are hopper measurements, and broken rock, roughly speaking, occupies almost twice the space in the hoppers which it occupies in place; and in the case of mud allowance must be made for an expansion of about 25% caused by disturbance.

The author of the paper carefully analyzes the time, but says nothing about wages and gives no costs. Finally his yardage is qualified by stating it is all hopper measurement. However, he says:

All the particulars of quantities are from actual hopper measurements, except those relating to the rock cutter and blasting float which are estimated, definite measurement being impracticable. The estimates are based on the result of the following comparative test, which was carried out in the summer of 1907:

(a) In 872 hr. of actual breaking the Lobnitz rock-cutter with 2 rams broke up 4,040 cu. yd. of rock, as measured in situ, or 4.63 cu. yd. per hour (equivalent to 8.42 cu. yd. in the hopper).

(b) At the same time the steam blasting float in 340 hr. of drilling and blasting (normal charges being used) broke up 1,440

cu. yd. of rock, as measured in situ, or 4.23 cu. yd. per hour (equivalent to 7.7 cu. yd. in the hopper).

In both cases the quantities were measured by taking borings to the rock before beginning the work, and soundings to the finished level after dredging.

The really valuable part of this paper is the careful segregation the author has made of time put in on different operations connected with the work. Here was a dredger that only spent 29.7% of the whole time in dredging and spent 35.4% on Sundays, holidays and meal hours. It was not contract work. There were in addition, 6 dredging grab cranes, a rock breaker and blasting float employed.

The six floating grab cranes for dredging were employed day and night, mainly in deepening water close to wharves and other places where the bucket ladder dredger could not be employed.

The ordinary working gang on each dredging crane consisted of 4 men—1 engineman, 1 fireman and 2 laborers. For the dredging alone they were not all required, but allowance had to be made for the hauling about of the heavy lighters and hopper barges.

In Table LXXXVI it must be remembered that No. 4 broke down finally on Feb. 5, 1907, and that No. 8 is a new dredge that did its first work Dec. 13, 1906. The dredgers worked 24 hr. per day in two 12-hr. shifts. The time therefore taken into consideration was the total number of hours in a year, 8,736 hr. All percentages refer to this total.

No. 3, a double chain crane, was purchased in 1904. The radius of action is variable to a maximum of 24 ft., maximum dredging depth 70 ft., maximum hoisting speed 110 ft. per minute, while the slewing speed was 1.6 revolutions per minute. The equipment consisted of two whole finger buckets each of 16 cu. ft. capacity, and one close bucket (clamshell) of 20 cu. ft. capacity.

Nos. 4 and 5, single chain cranes, were purchased in 1886. The radius of action is variable up to a maximum of 24 ft. The maximum dredging depth, 96 ft.; maximum hoisting speed, 72 ft. per min.; slewing speed, 1.3 rev. per min. The equipment of each consists of four whole finger grabs, each with a capacity of 15 cu. ft., and three half finger grabs, each with a capacity of 25 cu. ft.

No. 6, a double chain crane, was purchased in 1886. The radius of action is 22 ft. constant. Maximum dredging depth, 50 ft.; maximum hoisting speed, 100 ft. per min.; slewing speed, 3 rev. per min. The equipment consists of one whole finger grab, capacity 18 cu. ft.; one half finger grab, capacity 18 cu. ft.; one close bucket, capacity 12 cu. ft.

No. 7, a single chain crane, was purchased in 1900. The radius of action is variable up to a maximum of 30 ft. The maximum dredging depth, 80 ft.; maximum hoisting speed, 75 ft. per min.; slewing speed, 1.5 rev. per min. The equipment consists of four whole finger grabs, each with a capacity of 15 cu. ft., and three half finger grabs, each with a capacity of 25 cu. ft.

No. 8, a single chain crane, was purchased in 1906. The radius of action was variable up to 16 ft., but was later altered to be constant at 17 ft. 6 ins. The maximum dredging depth, 60 ft.; maximum hoisting speed, 120 ft. per min.; slewing speed, 3 rev. per min. The equipment consists of one whole finger grab and one half finger grab, each with a capacity of 32 cu. ft., and one close bucket with a capacity of 42 cu. ft.

Table LXXXVI is of considerable value in that it gives the percentage of time used in many ways. No. 4 and No. 8 did not work all the time, so Nos. 5, 6 and 7 are alone to be considered as representing a fair average. They show that about 53% of the total time was spent in actual dredging and that about 38% of the time was lost in meals, Sundays and holidays. Up to the time it broke down No. 4 seemed to be making a good average record. This study of the time spent is of as much importance as a study of costs when care is taken to analyze each item and study it in the light of personal experience. The time lost for repairs was very small, but how much repair work was done on Sundays and holidays we do not know. Another significant item is the lost time styled "miscellaneous." It amounts to as much as the time spent for repairs and may be due to bad management.

Lobnitz Rock Breaker Work at Black Rock Harbor, Buffalo, N. Y. In connection with the work of drilling and blasting the subaqueous rock at Black Rock Harbor, which is described on page 748, two Lobnitz rock breakers were used. The material was flinty limestone, blocky and full of seams and very hard. The rock breakers and drill boats were used in connection with each other, each type working where it was best suited.

The hulls were of timber carrying a cross-head 40 ft. above deck for a hoisting sheave, a 12 x 15-in. double cylinder hoisting engine, a 6-drum two cylinder 8 x 10-in. maneuvering engine, and a 100 hp. locomotive steam boiler. The ram was 29½ ft. long, 23½ in. in diameter and weighed 37,500 lb. It was operated by a 1½-in. cable over a 36-in. sheave.

It was found economical to use the rock breakers for depths of rock ranging from nothing to 6 ft. and the drill boats for greater depths. The maximum lift for the rock breaker was 3 ft. The striking points were spaced 4 x 5 ft. (In shale at Fort Edward where the strata lay diagonally, 3 x 3 ft. spacing gave

SUBAQUEOUS ROCK EXCAVATION

TABLE LXXXVI. TIME RECORD OF MACHINERY ON MALTA HARBOR WORK

Operations.	Lobnitz rock breaker.		Steam blasting float.		No. 3.		No. 4.		No. 5.		No. 6.		No. 7.		No. 8.	
	hrs.	%	hrs.	%	hrs.	%	hrs.	%	hrs.	%	hrs.	%	hrs.	%	hrs.	%
Actual breaking	3704	42.4	1863	21.3
Actual driving and blasting	1627	18.6	4074	46.6	4940	56.5	4170	47.7	4711	53.9	1427	16.3
Actual dredging	57	0.7	23	0.3	8	0.1	20	0.2	15	0.6	95	1.1	11	0.2
Shifting anchors and moorings	190	2.2	33	0.4	24	0.3	11	0.1
Stopped by bad weather	190	2.2	172	2.0	111	1.3	195	2.2	203	2.3	152	1.8	204	2.3	96	1.1
Misc. loss of time	190	2.2	414	4.7	95	1.1	388	4.4	240	2.8	117	1.3	82	0.9	31	0.4
Repairs	714	8.5
Idle time, Sundays, holidays, meals, etc.	3690	42.2	6320	71.3	3252	37.2	2635	30.2	3068	35.1	3744	42.9	3108	35.7	948	10.9
Other work	3588	41.1	194	1.9	235	2.7	484	5.6	536	6.1	38	0.4
Not on service at Malta	1272	14.6
Cu. yds. mud and sand	2813	1894	3732	8596	2012	5596
Cu. yds. rock (greater part broken previous years)	31188	14845	3259	8228	11475	3917	14460	3072
Total cu. yds.	31188	14845	6072	10112	15207	12513	16472	8668
Hourly rate, cu. yds.	7.7	3.7	2.5	3.1	3.0	3.5	6.7

best results.) The broken rock ranged up to 30 in. in greatest dimension, with 50% 6 in. or less in size, and could be readily handled by a 2-yd. dipper. The dredging resulted in a very even bottom. The height of the drop averaged 16 ft. The penetration was 6 in. below the required grade and the rock in general could be removed 12 in. below the required grade. The number of blows required at each point was from 20 to 30. Each move from point to point required only 30 to 45 sec.

Rock breakers were operated day and night and from 60 to 80 cu. yd. were shattered per 8-hr. shift. At Fort Edward in shale a rock breaker had a 50% better output. More work could have been accomplished had the passing traffic not occasioned losses amounting to 1.5 to 2 hr. per day.

Each breaker was operated by 4 men per shift as follows: 1 engineman who operated the maneuvering engine, 1 winchman on the ram hoist, 1 fireman, and 1 helper.

Lobnitz Rock Breaker Performance, Panama Canal. The machinery was mounted on a steel hull, 100 x 28 x 8 ft., divided into water-tight compartments, some of which were used as fuel oil and water tanks.

The ram or cutter was a heavy compressed-steel spar fitted with a hardened-steel conical point and was alternately hoisted and allowed to drop by its own weight. The range of tide and depth of channel required the use of three sizes of ram, viz., 30, 40 and 56 ft. long, weighing, respectively, 15, 16 and 19.5 tons. The hoisting was accomplished by means of a 2-in. steel cable attached to the top of the cutter and passing over a large sheave, supported vertically over the ram by an A-frame 65 ft. high; from the latter the cable leads to the drum of a powerful steam winch located on the deck and especially designed for continuous running. The winch was provided with automatic gear and a lubricated steel friction clutch, which allowed the cable to follow the fall and hoisted the cutter immediately after the blow was struck. The barge was maneuvered by a steam winch especially designed for paying in or out six wire ropes or chains, and was provided with quarters for the crew and an electric-light plant. Steam was supplied by a Scotch marine boiler.

After a rock shoal had been exposed by dredging the general practice was to attack the surface with the rock breaker at intervals of 4 ft. each way, the points of attack being located by ranges ashore and permanent marks on the deck. The cutter was operated in one position until the limit of penetration, which averaged 3.12 ft., was reached. After the entire area of the shoal had been gone over the rock breaker was removed and the broken rock dredged out, the operation of alternately breaking and dredging was repeated until the required depth was obtained.

The performance of the rock breaker for the three years of record was as follows:

	1909-10.	1910-11.	1911-12.
No. holes	15,961	42,110	36,798
No. blows	106,256	269,239	172,289
Blows per hole	6.66	6.4	4.68
Penetration per blow, ft.....	0.47	0.664	0.79
Penetration per hole, ft.....	3.12	4.24	3.69
Area covered, sq. ft.	266,230	648,033	563,617
Cu. yd. dredged	25,515	49,266	77,156

During a period of 15 months (1910-1911) the performance of a Lobnitz rock breaker, with a 19-ton ram and a drop 5 to 14 ft., was as follows:

Number of holes, in 15 mo.	43,214
Number of drops in 15 mo.	288,448
Drops per hole	0.7
Average penetration per hole, ft	4.3
Working time:	
Effective hours	3,535
Lost hours	1,650
Total hours	5,185
Area covered, sq. ft.	664,498
Cu. yd. broken	57,300
Cost per cu. yd.:	
Operation and maintenance	\$0.726
Overhead expense	0.071
Total per cu. yd.	\$0.797

During 6 months the rock breaker operated two 10-hr. shifts daily, and but one shift daily during 9 months. The yardage broken is the "theoretical" or "pay" yardage excavated by the dredges. The actual yardage broken was 50 to 60% of this.

Methods and Costs of Rock Removal on the Upper Mississippi River. (*Engineering and Contracting*, May 12, 1909.) The following is from a paper by C. McD. Townsend, Lieutenant-Colonel, Corps of Engineers, U. S. A., presented to the Western Society of Engineers relative to rock removal at Rock Island Rapids on the upper Mississippi River.

The methods of rock excavation employed were:

1. By cofferdam, drilling by hand, and use of common blasting powder.
2. By chisel and dredge.
3. By drillboat, submarine blasting with dynamite, and removal of rock by dredge.

(1) *By Cofferdam.* The method of constructing the dams was as follows: A breakwater was first constructed about ten feet above the proposed dam, to break the force of the current, and afford comparatively still water on the down stream side. It consisted of a series of cribs, generally about 10 x 10 ft., spaced about 16 ft. apart in the clear, and sunk by being filled with stone. Strong timbers were then laid from one crib to another,

and a sheathing of plank was placed along the connecting timbers with one end resting on the timbers and spiked to them, and the other end resting on the bottom, the plank being inclined at an angle of about 45° with the water's surface.

Timber work for an upper corner of the dam was framed and sunk in its proper place with two pairs of lower wall timbers, one pair extending down stream and the other across, attached by means of tie rods to the frame work, the timbers of each pair being secured to each other by the middle tie rods, the outer ends being held up to the surface by a float. Small rafts were moved along on each side of the line of the cofferdam, to afford sufficient space for working. Another pair of lower wall timbers (or stringers) was then fastened by means of tie rods to the floating ends already in, and secured to one another as before. A pair of upper timbers located above the surface of the water was then attached to the fixed part of the dam. Sinking planks were spiked to the pair of lower timbers nearest to the fixed part of the dam at right angles to their length and projecting below them as much as was found by sounding necessary to keep the lower wall timbers as nearly horizontal as possible. This pair of timbers was now sunk until the ends of the sinking plank rested on the bottom. The upper timbers were raised a few inches above the surface of the water and spiked to the sinking plank, the frame thus made being weighted to keep the timbers in place. The side planks which were chamfered to a thin edge at the lower extremities, were then driven into close contact with the bottom and spiked to the top timbers, care being taken to keep them in contact with the lower timbers. The space was then ready for filling. The puddling or filling was taken from the river bed and shore, and consisted of clay mixed with gravel, which material was always found at moderate distances from the work.

After the filling became compact the water was slowly pumped out of the cofferdam and the space inclosed was ready for the work of excavation. No special tamping or packing was employed, the material being such as to settle readily and spread into the cavities. The size of timber and thickness of plank varied according to depth of water and consequent height of dam and pressure. In deep water three rows of stringers were sometimes used as affording greater stability, and the dams were often braced from the inside at threatened points. The thickness of the filling of the upper and lower ends was about 10 ft., they being generally in deeper water than the sides, which had ordinarily an inside thickness of about 8 ft.

Although the dams used in the improvement of Rock Island Rapids were in general built in comparatively shallow water

(from 6 to 14 ft. in depth), Sycamore dam, which was the largest built, attained at some places a height of 26 ft. above the bed of the river.

The quarrying was performed by the use of the ordinary hand drill and blasting powder. The drills used varied from 1½ to 2½ in. in diameter, and the depth of holes from 1 to 4 ft. To avoid the effect of moisture in the rock and to form a water-tight magazine, the holes were sponged out and partially filled with a soft pliable clay. The drill was then forced into this clay, pressing it against the sides and making a water-tight lining. The powder used was 1.9 lb. per cu. yd.

When the excavation was finished and inclosure cleaned of broken rock, etc., the water was let in and the dams and cribs removed by dredge. Cofferdams were frequently damaged and sometimes broken in by passing steamers and rafts. The following table shows the area of cofferdam work done at the Rock Island Rapids, and the yardage:

	Lin. ft.	Area Acres.	Rock excavated cu. yds.
Duck Creek	1,310	2.29	5,183
Moline	2,645	6.03	16,958
Sycamore	5,171	43.91	17,376
Campbells	5,760	43.07	7,832
Smiths	2,209	4.84	5,598
Upper	1,710	2.26	3,697
Between Smiths and Sycamore No. 1	960	805
Between Smith and Sycamore No. 2	840	817
Crab Island No. 1	1,100	1,077
Crab Island No. 2	1,020	1,446
Lower No. 1	1,505	2.27	2,649
Lower No. 2	1,480	2.81	2,340
Total excavated by coffer-dams	65,778

(2) *By Chisel and Dredge.* The chisel was used for breaking rock that was found in patches or in boulders too small in area to justify the construction of an inclosing cofferdam. The use of the chisel boat dates back to 1855, when Major J. G. Floyd, United States Agent, used on the Des Moines Rapids a stick of oak timber 12 ft. long and about 12 in. square, with bars of railroad iron let into the side as ribbands to work in the uprights prepared for the purpose and set up on one end of the boat. The timber was shod with a conical shoe of wrought iron weighing about 300 lb., and having a pyramidal point of steel. The chisels were afterwards made of wrought iron 9 ft. long with a steel point. The upper end worked loosely in a "head" from which the chisel was suspended, and was so arranged as to allow the chisel to glance from the rock without injury to the boat. Its weight was about 3½ tons. The steel point was detachable, so that when it became dull it could be removed and another substituted. The "head" was made of tough elm or bass wood

and raw hide bolted together so as to bring the raw hide at the neck of the chisel, where there was the greatest wear. The chisel was operated by machinery and leads similar to those of a pile driver, which were placed on a suitable flatboat. The fall was about 7 ft. The boat was maneuvered by anchors, lines and windlasses, so as to cover the points desired, the chisel working from the down stream end of the boat. On the Rock Island Rapids the chisel was reported to be very efficacious where the cutting was small (18 in. or less), while on the Des Moines Rapids it was not as satisfactory. About 19,640 cu. yd. were removed by chisel and dredge at 11 different places in the improvement of the Rock Island Rapids.

(3) *By Drillboat, Submarine Blasting and Dredge.* In 1875, at St. Louis Chain, tripods were placed on the rock to be excavated, and from platforms built on the tripods holes were drilled by hand, the rock blasted, and the broken rock raised by a derrick boat. About 305 cu. yd. of rock were removed by this means. While this method can be employed advantageously for small patches of rock, it has been found with the development of the steamdrill that it was more economical to mount the drill on a barge, which could be moved readily from place to place, and since 1878 the work of rock removal has been performed on the Rock Island Rapids by means of the drillboat. The latest form of drillboat employed consists of a barge 80 ft. long by 18 ft. wide, on one side of which are mounted two steamdrills. A boiler-room and blacksmith shop occupy the middle of the boat, and the boat is held in position by spuds. Maneuvering lines are also attached for moving the boat out of danger during blasting operations.

The usual method of procedure is as follows: The drillboat is first spudded in position, and holes 3 in. in diameter are drilled 4 ft. apart into the bed rock and are sunk to a depth of 3 ft. below grade to avoid reblasting. The distance between rows of drill holes is also usually 4 ft. The holes are then freed from debris by flushing them out with water discharged through a hose with a long nozzle. The charges of dynamite are then pushed to the bottom of the holes through a long tube having a slot in the side to accommodate the fuse wires, and a wad of old junk is rammed down on top of each load to tighten and hold it securely in place. The number of loaded holes on a line, ranging from 1 to 17, having been finally connected by splicing the wires to form a circuit, the drill boat is moved away to a distance of 50 to 75 ft., and the blast is then fired with a battery. The average amount of dynamite used per solid cu. yd. of rock blasted is 2.29 lb., and the average amount of solid rock blasted per day of 16 hr. by one drillboat is 31 cu. yd. There is great

variation, however, due to depth of drilling, quality of material, and the amount of sand and gravel found overlying the reefs. In deep ledge rock which breaks up so as to permit holes to be drilled 8 ft. apart, an output of 72 cu. yd. of solid rock per day of 16 hr. was obtained, with an expenditure of 1.17 lb. of dynamite per cubic yard.

The following is the quantity of dynamite generally used for holes of various depths and in different kinds of material:

Depth of hole	3ft.	4ft.	5ft.	6ft.	7ft.	8ft.
Dynamite in hard rock, lb.	2½	3¼	4	4¾	5½	6¾
Dynamite in rock, medium to soft, lb.	2	2¾	3¼	3¾	4½	5¾

Table LXXXVII gives the cost of rock excavation at Rock Island Rapids by various means, from 1868 to 1905.

TABLE LXXXVII. COST OF ROCK EXCAVATION, ROCK ISLAND RAPIDS

Year	Locality	Solid. cu. yd.	Per cu. yd.	Method.
1868	R. I. Rapids	21,253	\$10.00	
1869	"	12,671	13.00	
1870	"	1,172	13.00	Contract: coffer-dams, steam and hand drills; powder.
1870	"	7,833	11.50	
1872	"	5,599	10.35	Hired labor: hand-drills, dredge, powder.
1872	"	1,622	11.00	
1872	"	3,698	14.00	Hired labor: steam drill boat, dredge, dynamite.
1875	"	2,650	12.00	
1876	"	2,341	12.00	Contract: chisel and dredge.
1876	"	305	11.13	Contract: chisel and dredge.
1879	"	682	10.78	Hired labor: steam drill boat, dredge, dynamite.
1886	"	445	7.00	
1887	"	1,343	8.47	"
1889	"	2,451	5.43	"
1890	"	1,398	7.20	"
1891	"	2,704	5.76	"
1892	"	1,990	4.73	"
1893	"	2,919	4.71	"
1894	"	3,852	4.70	"
1895	"	6,158	3.75	"
1895	D. M. Rapids	3.05	"
1896	R. I. Rapids	5,271	4.42	"
1897	"	3,105	4.31	"
1898	"	4.94	"
1898	"	6,320	3.37	"
1898	D. M. Rapids	5,449	2.36	"
1898	Henderson Rapids	693	4.14	"
1899	R. I. Rapids	5,406	3.50	"
1899	R. I. Harbor	1,441	2.47	"
1899	Rockingham	4,730	2.93	"
1900	R. I. Rapids	3,631	3.30	"
1901	"	1,000	4.34	"
1902	"	6,201	2.69	"
1903	"	6,425	3.65	"
1904	"	5,018	6.00	"
1905	"	8,670	1.00	Dredging rock blasted preceding year.

Records of Dredges on Rock Work. (*Engineering and Contracting*, July 16, and Aug. 13, 1913.) During the year ending

June 30, 1912, about 20 bucket dredges and 40 dipper dredges were operated by the United States Government.

Albany. This dredge has a 70 x 30 x 4-ft. 9-in. creosoted wood hull, and a displacement of 75 tons; was built in 1908 by hired labor for the U. S. Engineer Department and cost with outfit \$18,584. The dredge is operated by an 8¼ x 10-in. engine, has an orange peel bucket of 1 cu. yd. capacity, a 60-ft. boom, and can dredge to a depth of 15 ft. No scows, towboats or launches were used. The work consisted in removing rock reefs and boulders in the Flint River, Georgia, and the material was dumped on the side of the channel. Working in 2 ft. of water she dredged to an average depth of 3½ ft., removing a total of 11,269 cu. yd. entirely of rock. Her operating record was as follows:

Days worked	211
Hours worked per day, average	10
Max. hour's output, rock, cu. yds.	35
Max. day's output, rock, cu. yds.	350
Time lost, days:	
Repairs, machinery	5
Weather	20
Shifting	5
Total	30

Out of commission, including 14 hours per day at rest. 125 days

The cost of operating the dredge was as follows:

Pay rolls	\$2,597
Coal	357
Kerosene	16
Lubricating oil	6
Supplies:	
Subsistence	773
Machinery	23
Miscellaneous	59
Renewals	788
Repairs, machinery	250
Laundry, ice, etc.	32
Total dredge	\$4,909
Office, superintendence, etc.	330
Extra, repairs, barges	330
Grand total	\$5,569

For 11,269 cu. yd. of excavated material these totals give per cu. yd.:

Dredge operation	43.56 ct.
Office and extra repairs	5.86 ct.
Total	49.42 ct.

Kentucky. The dipper dredge "Kentucky" operating in the Chattanooga district, has a 100 x 34 ft. x 6 ft. 10-in. steel hull, and a displacement of 326 tons. The dredge was built in 1900 at a cost with outfit of \$36,300, and rebuilt in 1908 by the United

States. The dredge operated during the year in the Tennessee River. She has two dippers, one of 2 cu. yd. capacity and one of 4 cu. yd. The boom is 45 ft. long, and the maximum dredging depth is 16 ft. She dredged from a depth of 2.5 ft. at low water to 6 ft. at low water, removing about 5,700 cu. yd. of rock and 112,500 cu. yd. of mud. Her operating record was as follows:

Days worked	165
Hours worked per day, average	8
Distance to dump, miles	1/4
Scows loaded per day	25
Average scow load, cu. yd.	60
Time to load scow, hours:	
Rock	2
Gravel	1/2
Max. hour's output, cu. yd.	200
Max. day's output, cu. yd.	1,750
Time lost:	
Repairs, hull	60
Repairs, machinery	16
Weather	75
Shifting	3
Total	154

The field cost of operating the dredge was as follows:

Pay rolls	\$ 7,900
Coal	1,600
Kerosene	38
Lubricating oil	65
Supplies:	
Subsistence	2,000
Machinery	1,000
Laundry, ice, etc.	144
Miscellaneous	125
Total dredge	\$12,870
Towboat operations	8,374
Scow and barge repairs	200
Total field cost	\$21,444
Office expenses, superintendence, survey, etc.	1,800
Grand total	\$23,244

The field cost per cu. yd. is estimated as follows:

Mud or sand	\$0.15
Rock	1.00

Kwasind. This dredge, operating on the Tennessee River, has a steel hull, 80 x 28 x 6 ft. 6 in., and a displacement of 187 tons. The dredge was rebuilt in 1908, and extensively repaired in 1911 and 1912. The original cost was \$11,500, with a cost for outfit of \$1,500. She has a 1.5 cu. yd. dipper, and a 38 ft. boom. Her maximum dredging depth is 9 ft. The capacity per hour of mud and sand is 135 cu. yd., and of blasted rock 80 cu. yd. She

dredged from a depth of 2 ft. below low water to 4 ft. below low water and removed a total of 47,000 cu. yd. of mud and 28,500 cu. yd. of rock. Her operating record was as follows:

Days worked	144
Hours worked per day, average	8
Distance to dump, miles	1
Number of scows loaded per day	7
Average scow load, cu. yd.	60
Time to load one scow, hours	1½
Max. hour's output, cu. yd.	100
Max. day's output, cu. yd.	1,000
Time lost, days:	
Repairing machinery	60
Weather and high water	98
Shifting	2
Total	160

The field cost of operating the dredge was as follows:

Pay rolls	\$ 3,105
Coal	462
Kerosene	6
Lubricating oil	91
Supplies:	
Subsistence	943
Machinery	650
Repairs:	
Hull	610
Machinery	4,004
Laundry, ice, miscellaneous	56
	<hr/>
Operating cost — towboat	\$9,927
Repairs to scows	4,704
	2,437
	<hr/>
Total field cost	\$17,068
Office superintendence, etc.	640
	<hr/>
Grand total	\$17,708

The cost per cubic yards are estimated as follows:

	Per cu. yd.
Field cost mud or sand	\$0.155
Field cost rock	0.345
Gross cost mud or sand	0.161
Gross cost, rock	0.350

Tennessee. The dredge "Tennessee" has a 100 x 34 ft. x 6 ft. 10-in. wooden hull, and a displacement of 375 tons. She was built in 1910, and cost with outfit about \$21,739. She is operated by a 12 x 18-in. engine, and has two dippers of 1½ and 2 cu. yds. capacity. The boom is 45 ft. in length. The maximum dredging depth is 16 ft. Her nominal capacity is 188 cu. yd. of sand or mud per hour, and 12 cu. yds. of rock per hour. She dredged from a depth of 2 ft. at extreme low water to 5 ft. at extreme low water removing a total of 6,932 cu. yd., almost entirely of rock. Inadequate drilling equipment and the flinty character of the rock rendered progress very slow. The operating record was as follows:

SUBAQUEOUS ROCK EXCAVATION

807

Days worked	199
Hours worked per day, average	8
Distance to dump, miles	%
Scows loaded per day:	
Maximum	5
Minimum	1
Average scow load, cu. yd.	50
Time to load one scow, hours	4
Max. hour's output, rock, cu. yd.	50
Max. day's output, hard rock, cu. yd.	250
Time lost, days:	
Repairs, hull	6
Repairs, machinery	11
Weather and high water	101
Total	118

The cost of operating the dredge was as follows:

Payrolls	\$ 7,860
Coal	1,600
Kerosene	24
Lubricating oil	75
Supplies:	
Subsistence	1,920
Machinery	1,250
Miscellaneous	150
Repairs to hull	350
Laundry, ice, miscellaneous	288
Total, dredging only	\$13,517
Scows; repairs, etc.	1,100
Fuel, for towing	3,420
Grand total	\$18,037
Cost per cu. yd., hard rock, dredging only	\$1.95
Cost per cu. yd., dredging and transportation	\$2.60

Phoenix. This dredge has a wood hull 80 x 30 x 8 ft., with a displacement of 186 tons. Dredge was built in 1885, and cost, with outfit, about \$36,125. She is operated by a 12 x 18-in. engine, has a 1½-cu. yd. dipper, a 34-ft. boom, and can dredge to a depth of 17 ft. Her capacity per hour is 48 cu. yd. in rock. She dredged from a depth of 3 ft. above grade to 1 ft. below grade, removing 21,393 cu. yd. of blasted limestone. Her operating record was as follows:

Days worked	166
Hours worked per day, average	10
Distance from dump, miles	1½
Scows loaded per day	6
Average scow load, cu. yd.	80
Time to load one scow, hours	1½
Max. hour's work, cu. yd.	56
Max. day's work, cu. yd.	580
Time lost, days:	
Repairing machinery	5
Weather	2
Total	7
Out of commission	164

The cost of operating was as follows:

Payrolls	\$ 2,240
Coal	961
Kerosene	5
Lubricating oil	47
Supplies:	
Subsistence	446
Miscellaneous	167
Repairs, machinery	428
Total, dredge	\$ 4,204
Barges and scows, repairs	3,458
Barges and scows, miscellaneous	286
Total field cost	\$ 8,038
Office, superintendence, etc.	1,501
Extra repairs, dredge	590
Extra repairs, barges	274
Grand total	\$10,493

For 21,393 cu. yd. of material excavated these totals give:

	Ct. per cu. yd.
Dredge operation	20.07
Transporting spoil	17.50
Office and extra repairs	11.48
Total	49.05

Fulcan. The dipper dredge "Vulcan" has a wood hull 80 x 30 x 8 ft., with a displacement of 212 tons, was built in 1883, at a cost, with outfit, of \$19,450. She is operated by a 12 x 18-in. engine, is equipped with a 1 $\frac{3}{4}$ -cu.-yd. dipper, and a 34-ft. boom, and can dredge to a depth of 17 ft. Her nominal capacity per hour is 40 cu. yd. in rock. She dredged from a depth of 3 ft. above grade to 1 ft. below grade, removing a total of 16,863 cu. yd., all blasted limestone. Her operating record was as follows:

Days worked	165
Hours worked, per day	10
Distance to dump, miles	1 $\frac{1}{2}$
Scows loaded per day	5
Average scow load, cu. yd.	80
Time to load one scow, hours	2
Max. hour's output, cu. yd.	48
Max. day's output, cu. yd.	480
Time lost, days:	
Repairing hull	1
Repairing machinery	11
Weather	2
Total	14
Out of commission	164

The cost of operating the dredge was as follows:

Payrolls	\$ 2,242
Coal	1,271
Kerosene	5
Lubricating oil	47
Supplies:	
Subsistence	444
Miscellaneous	177
Repairs, hull	6
Repairs, machinery	286
Total, dredge	\$ 4,478

SUBAQUEOUS ROCK EXCAVATION

809

Operating towboats	\$ 3,920
Scow repairs	84
	8,482
Total field cost	\$ 8,482
Office, superintendence, etc.	1,471
Extra repairs, dredge	590
Extra repairs, barges	268
	10,806
Grand total	\$10,806

For 16,863 cu. yd. of dredged material these totals give costs per cubic yard as follows:

	Ct.
Dredge operation	26.55
Transporting spoil	23.74
Office and extra repairs	13.78
	64.07
Total	64.07

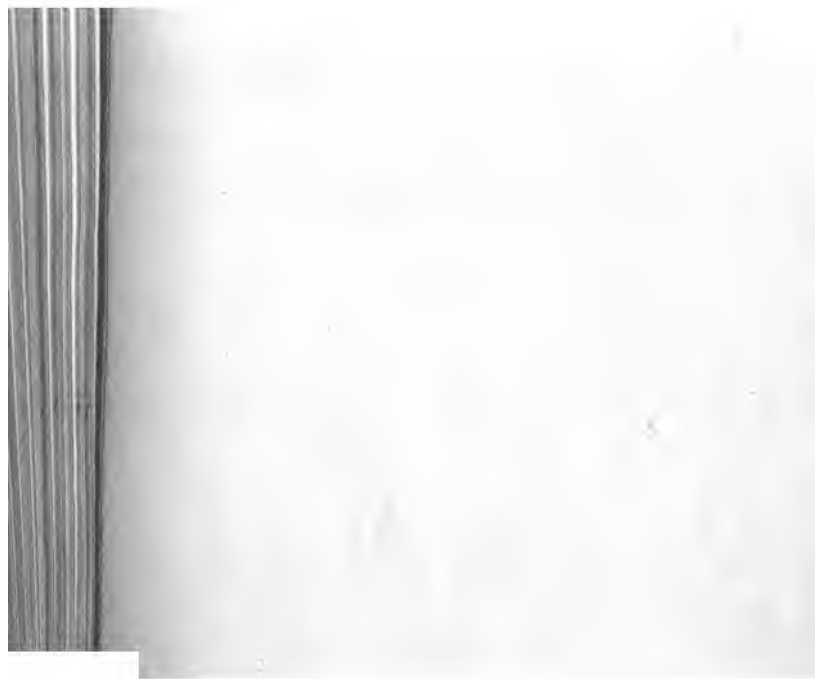

INDEX

Abel Block	457	Bastard Granite	6
Administration Costs	683	Battery, Blasting	453
Adobe Shots	638	Beds of Rock and Ore	5
Air, Compressed		Bench, Height in Open Cut	
Cost of	73, 251	Work	584
Flow through pipes	231	Bishop Derrick Excavator	506
Table XXIX	232	Bits for Channelers	556
Merits of	234	Black Powder	404
Pipe lines for transmitting	228	Blacksmith's Tools for Sharp-	
Pipe sizes and weights,		ening Drill Bits	54
Table XXVIII	229	Blacksmith Shop Equipment	
Reheaters	229, 230	Cost	62
Reheating	228, 229	Blast	
Required to run a 1-drill		Cable Drill Hole	498, 603
plant	221	Chamber, see Blasting.	
Splitting Granite by	78	Hell Gate	726
Air Compressing (see Com-		Holes, see Holes.	
pressing)	241	Large Side Hill	621
Air Compressors, see Com-		Percussive Drill Holes	497
pressors, Air.		Railroad Cut, Large	633, 634
Air Consumption	72	Table of Data	497, 498
In terms of steam consump-		Water Cushion	572
tion	223	Blasting	
Mining work	217	See also Charging, Firing, etc.	
Plug drills	545	Augers, prices	401
Percussive drills	214	Battery	453
Air Drills	68	Boulder	607, 641, 643
Also see Drills, Air Ham-		Abode Shots	638
mer, Hammer, etc.		Block Hole Tests	638
Air Feed, Telescopic	121	Blockholing	636
Air Hammer Drill Bits	46	Dynamite Charges for	637
Also see Drill Bits.		Mud Capping	636
Air Jet to Remove Cuttings	135	Snakeholing	636
Air Pressure		Cable Drill Holes	491
Effect on drilling speed	227	Caps	456, 461
For Drilling	168	Cemented Gravel Ballast	496
Air Required by Drills	218	Blasting, Chamber	474
Air Wash-Out for Sludge	140	Chamber Blasts, Large	487, 488
Andesite	8	For rock-fill dams	474, 605
Aqueous Rock Species	3	In Quarries	479
Artesian Well, Cost of	290	R. R. work	485
Atlas Powder	410	Charging and Firing	443
Auger Boring, Speed with	205	Compared to Rock Breaking	732
Auger Drills, Rotary	297	Copper Ore	603
Augers for Boring Blast Holes	35	Costs at Panama	683
Augers, Rotary Steam Driven	68	Crater Theory	474
Automatic Feed Drill	83	Culebra Cut	675
Autotraction Drill Rigs	141, 147	Data Tabulated Summary	496
Aymard's Dust Collector	135	Detonators	456
Azi-clinometer	343	Drill Holes, Placing	467
Backfilling Sewer Trenches in		Dynamite and Powder To-	
St. Louis	719	gether	472
Bailer for Cable Drilling	292	Efficiency of Different Meth-	
Barges, Submarine Drilling	728	ods	497-500
Bar Mounting, Use of	103	Electric Detonator or Cap	458
Basalt	8	Explosive, Quantity of	405
		Firing by Electricity	447

- Blasting**
 Firing Methods 454
 Fuse, price 462
 Gelatin 413
 Glacial Drift 495
 Grand Central Station Meth-
 ods 492
 Granite 617
 Gravel for Dredging 495
 Hardpan 492
 Holes, placing 467
 Knox 74, 562
 Large Compared to Single
 Shots 620
 Los Angeles Aqueduct 695
 Machines, prices 460
 Mat 706
 Miners' Squibs 455
 Misfires 451
 Panama Canal 675, 677
 Powder and Dynamite To-
 gether 472
 Priming 449
 R. R. Chamber 485
 Rock for Dam Filling 605
 Safety Fuse 455
 Springing Holes 471
 Strength of Explosion Due to
 Strength of Cap 457
- Blasting,**
 Subaqueous 752, 754, 764
 Ashtabula Harbour 756
 Australia 775
 Black Tom Reef 776
 Brisbane River 768
 Charging Formula 726
 Charging Pipe 747, 752
 Compared to Lobnitz
 Breaking 788
 Costs 749, 752
 Hell Gate 778
 Malta 793
 Mississippi River 799
 Portsmouth Navy Yard 780
 Surface of Rock 723
 Tennessee River 760
- Blasting**
 Supplies, Prices of 459
 Thaw Kettles, Prices 467
 Theory of 463
 Trench Work 703, 718
 Wire, Prices 467
 Wiring, Methods of 450
 Blockhole test blasting 638
 Blockholing 636
 Blockholing Boulders, see
 Boulders, Breaking.
 Blockhole Drilling 639
 Also see Drilling, Block
 Holes.
 Blower Hose on Plug Drill ... 135
 Bluestone 6
 "Hudson River" 9
 Boiler, Capacity for Steam
 Drills 234
 Efficiency 232
 Portable for Trench Work ... 716
 Boring Blast Holes with Augers
- Boring Blast Holes**
 Speed with Augers 205
- Borings, Wash**
 Cost Compared to Shot
 Drilling 390
- Boulder Blasting**
 See Blasting, Boulder. 607, 636
- Boulders**
 Blockholing, Table LXXIII.. 642
 Breaking 643, 646, 647
 Blockholing 647
 By Drop Hammer 644
 Hammering 647
 Heating 646, 647
 Mudcapping 647
 Sledging 641, 647
 Undermining 647
 Handling 627
 Handling on Chicago Canal. 654
 Los Angeles Aqueduct ... 694
 Sledging 641, 647
 Undermining, or Snakeholing
 Table LXXIV, Costs ... 643
- Box Drill** 150
- Breaker, Rock**
 Cutting Point, Lobnitz ... 783
 On Danube 730
 Lobnitz 724, 730, 781
 Nobiling, Inventor 730
 Suez Canal 732
- "Breaking" refers to the break-
 ing of rock by the impact
 of a falling weight 724
- Breaking**
 Black Rock Harbor, Buffalo 796
 Compared to Drilling and
 Blasting 732, 787, 788
 Economic Limits 732
 Lobnitz Breaker 780
 Lobnitz on Suez Canal 785
 Malta 791
 Manchester Ship Canal ... 790
 Mississippi River 799
 Panama Canal 798
 Speed of Lobnitz 784
 Suez Canal 732
 Bridge Conveyor Excavator.. 701
 Broach Channeling 548, 574
 Brown Cantilever Crane 662
 Brownstone, "Connecticut" and
 "New Jersey" 8
 Brunton Bit, the 41
 Bucket, also see Dredge.
 Orange Peel 760, 804
 Bull-bit 42
 Bull Points for Trimming Rock
 Cut by Hand 36
 Sharpening Same 36
- Cable Drill, see Drill, Cable..**
 Fittings, Prices 320
- Cableways**
 Arrowrock Dam 528
 Chicago Canal—Lidgerwood. 633
 Delay Causes 637
 Morena Dam 531
 Moving 537
 Prices 533

- Cableways**
 Sewer 536, 710
 West Neebish Channel 559, 700
Caisson 723, 729
Caliper for Diamond Drill Holes 346
Calyx Drilling Outfit 392
Camp Installation Costs 619
Canal
 Chicago Main Drainage 648, 666
 Cost Distribution by % 656
 General Conditions 648
 N. Y. Barge, Lock No. 5 Excavation 703
 Panama 670
 Also look under heading of information desired, such as power plants, slides, etc.
 Panama
 Equipment 671
 General Conditions 670
 General Statistics and Equipment 671
 Lock Excavation 673
 Wages and Force 672
 Welland 753
 West Neebish Channel 700
Cap. Detonating 456
 Electric 458
Car, Cars,
 Capacities in Tenn. 608
 Hauling Stone with Horses 519, 520
 Hauling Cost 521
 Hoist Incline 664
 Panama Canal 671, 680
 Peteler Dump 650
 Prices 521
Carbon in Drill Steel 43, 50
Carbonite 411
Carr Bits 68
Cart, Carts
 Capacities in Tenn. 608
 Hauling Cost 523, 525
Casing
 Cementing 300
 Circulator System 304
 Deep Wells 304
 Driving Pipe 261
 Hydraulic Elevator for Moving 309
Cementing Bore Holes in the Brejcha System of Diamond Drilling 377
Chalk 10
Chamber Blasts 474
 Also see Blast and Blasting.
Channeler Bits 556
 Specifications of Steels 558
Channeler
 Duplex 551
 Electric Air 556
 Power Required 556
 Prices 556
 Simplex 550
 Sizes, Tables LXII and LXIII 554
Channelling
 Broach 548, 574
 Chicago Drainage Canal 667
 Depth of Cut 556
 Dimension Stone 553
 Limestone Test 561
 Marble 566
 Marble Block 23 x 13 x 5 Ft. 570
 N. Y. Barge Canal 703
 Niagara Falls 552
 Speed of Cutting 559
 Speed with Sullivans 560
 West Neebish Channel 559, 700
Charging. See also Blasting.
 Cable Drill Holes 589
 Hell Gate, N. Y. 779
 Pipe for Subaqueous Blasting 752
 Subaqueous, Tennessee River 754, 764
 Subaqueous—Tube 746, 752, 756
 Trench Holes 700
Chersen Drill 175
Chicago Main Drainage Canal, see Canal 648
Chisels, Rock Breaking 302
Circulator System of Sinking Casings 304
Classification of Excavated Materials in Specifications 17
Clay—Boring with Augers 35
 Excavating Very Tough 649
 Holes 6
 Clearing, Costs at Panama 683
 Coolinga Oil Fields 303
 Cofferdam 723, 799
 Puddling or Filling 800
 Collar Pipe for Drill 139
 Column Mounting 96,
 Compressed Air. see Air, Compressed.
Compressing Air
 Above Sea Level 221
 H.p. Required to Compress Cu. Ft. to Given Pressures, Table XIII 213
 Steam and Electricity Compared 241
 Water Wheel, Electric Motor and Hydraulic Compressor, Comparative Cost 246
 Water System 244
Compression, Work of 212
Compressor, Air
 Capacity, Calculation 219
 Cost and Coal Consumption 237
 Cost of Floating Plant 240
 Cost of Large Plant 239
 Efficiency Test at Jerome Reservoir 236
 Gasoline 247, 248, 711
 Mining Plant Cost 239
 Panama Canal 686
 Plant Installation Cost 238
 Portable Gasoline 247, 248, 711
 Prices 237

- Compressor
 Prices of Portable Gasoline 249, 250
 Sewer Trench Work 713
 Small Portable 247, 248
 Various Types 235
 Water Driven 243
- Contracting to Gangs of "Station Men" 614
- Contractors' Powder
 See Powder, Contractors'.
- Conveying, see also Transportation 680
- Conveying Rock
 Car Incline Hoists 664
 Costs by Different Methods on Chicago Drainage Canal 667
 Cost on Chicago Canal 663
 Cranes on Chicago Canal 663
 Conveyor Crane, Hullett-McMyler 658
 Conveyor Excavator on Barge Canal, N. Y. 701
 Copper Ore, Cable Drill Blast, "Coquina" (Florida Limestone) 603
 Cores, Sizes of 327
 Cost. This is understood to apply to every item in the index, except those in which, obviously, costs do not enter.
- Cost Keeping 207
 Coyote Hole 487
 In Hardpan 649
 Cradle, or Shell Mounting 122
- Crane, also see Conveyor.
 Brown Cantilever 661
 Crater Theory of Blasting 464
 Cross Bit 39
 Crushed Stone, Settlement of.. 15
 Crushing, Limestone 598
 Panama Costs 690
 Culebra Cut 674
 Cut, see Open Cut, also Railroad Cut.
- Cut, Side Hill with 2 Shovels.. 697
 "Cutting In" Holes 469
- Davis Cutter 381
- Day Labor on Subaqueous Rock Work 760
- Derby Tubular Drill Bit 45
- Derrick
 Air Hoist on Chicago Canal. 653
 Breaking up Boulders 645
 Excavator, Bishop 506
 Geraldine Double Boom 660
 Handling Mica Schist 507
 Handling Stone 519
 Hullett-McMyler 659
 Prices 561
 Scows 737
 Scows, Operating Costs 740
 Well Drill 253
- Detonators (Caps) 456
 Electric 458
- Detroit River Improvement
 Subaqueous Drilling and Dredging 740
 Devil, for Handling Boulders.. 627
 Diabase 8
 Diagram of Relation of Unit Costs of Rock Excavation to Depth of Cut .. 635
- Diamonds 328
 Diamond Consumption 331
 Prices 328
 Setting 330, 374, 395
 Setting, Brejcha System 374
- Dietz Drill 148
 Diorite 8
 Dipper Dredge "Kentucky".... 804-809
- Ditching
 Cost of Open—with Steam Shovels 609
 Los Angeles Aqueduct 602
 Diversity Factors 220
 Divers, Melbourne 772
 Diving Bell 729, 729
 Dolomite 10
- Drainage and Stream Diversion at Panama 683, 685
- Dredge
 Dipper 775, 778, 804-9
 Grab Crane 791
 Hopper Ladder 791
 Ladder 774
 Orange Peel Bucket 804
 Stern-wheel 793
- Dredging
 Ahnapee Harbor 756
 Boulders in Woods Hole 778
 Derrick Scows—Costs 740
 Detroit River, Table
 LXXXIII 738
 Eagle Harbor, Mich.. 775
 Hell Gate, N. Y. 779
 N. Y. Harbor 759
 Oconie River 770
 Plant Costs 749
 St. Lawrence River 754
 U. S. Gov't Records 803
 Way's Reef, N. Y. 777
 Welland Canal 754
- Drifting Contest in Arizona .. 171
- Drill
 Items pertaining to the drill, its parts, mountings and accessories will be found under *drill*; items pertaining to operation, maintenance, etc., under *drilling*. Also see Trade Names. Also Drilling.
- Air—Operated by Steam... 714
 Air Hammer 105
 Air Hammer in Small Sewer Trenches 712
 Air Required by 218
 Auger 21
 Auto-traction 141
 Baby Ingersoll 189, 190

Drill Bits		Drill Bits	
Air Hammer	46	V-Bit	63
Air Hammer, Shapes and Speeds; Table IV	49	Weakness of Sharp Edges	46
Angle Between Faces of Cutting Edge	46	Weight of Steels for Percussive, Table V	50
Blacksmith's Tools for Sharpening	54	Weights of Steel, Solid and Hollow, Lbs. per Lin. Ft., Table VI	51
Blunt	64	Well	261
Bull Bit	63	Drill Boat	
Carbon in	50	Ashtabula Harbor	757
Carr Bit	68	Brisbane River	768
Chisel Edge	39	British Columbia	788
Clearance Angle	39	<i>Hurricane</i>	741
Concrete Drilling	65	Subaqueous Rock Work	724
Cross Bit After Successive Hand Sharpenings	55	Tender	703
Derby Tubular	45	Drill	
Diamond	326	Brandt Rotary	147
Fishtail for Rotary	311	Drill, Cable	
Grades of Steel	53	Blast, Hole Work	252
Hand Hammer	37	Boiler for	288
Hollow Steel for Special Conditions	62	Cyclone Outfit Complete	393
Hollow Steel, Hole Ending Between Wings Above Point of Bit	65	Fittings, Prices	320
"Jackhammer" and "Rota- tor" Steels	48	Operating Cost on Penna. R. R.	266
Lug	45	Price	256, 288
Machine	39	Quarry Work	586
Mother Hubbard	286	Repairing and Rebuilding	287
"Mudding" Difficulties	64	Star—Sizes	252
Mudding Properties	40	Drill	
Percussive, Size of	49	Carriages for Trench Work	714
Reaming Edge	39	Chersen	175, 189, 190
Shapes for Pneumatic Hammers	47	Churn	21, 273, 772
Sharp & Hughes Cone	311	Climax Little Wonder Tappet	190
Sharpeners, Ingersoll and Sullivan	57, 58	Design and Construction, re- rent Developments	69
Drill Bits, Sharpening		Drill, Diamond	
Equipment Cost	62	Brejcha System	372
Charcoal Manufacture	61	Complete Outfit	337
Churn Bits	286	Derricks—Prices	337
Cooling Bath	54	Hand Power	335
Costs 56 to 62	183	Instructions for Operat- ing	338
Fuel for Forges	59, 60	Price of	334
"Fuller and Dolly" System	56, 60	Rig	339
Hand and Power Compara- tive Costs	58	Submarine Work	727
Hand Bits	50	Drill Efficiency, Testing at	
Machine Bits	53, 54	North Star Mines, Cal.	207
Machine or Power	56	Drill, Electric	
"Set Hammer" System	55	Box Drill	118
Tools for	54	Ft. Wayne	198
Temperature Indicated by Colour	53	Hammer	197
Tempering	54	Percussive	149
Tempering Hand Bits	52	Solenoid	148
Drill Bits		Extractor	141
Six Point Bit	63	Float	761
South African	43	Flottman	189, 190
Spudding Bits and Augers Used in Diamond Drill- ing	340	Gasoline Air	153
Steel for	53	Gasoline, Rice	158
		Gasoline, Scott	155
		Gordon	189, 190
		Grose	189, 190
		Drill, Hammer	
		Air—Operated by Steam	714
		And Piston Compared	74, 719
		Classification According to Valves	10F

- Drill, Hammer**
- Electric 149
 - Evolution 75
 - Handling a 120
 - Mountings 121
 - Quarry Work 545
 - Rotation 106
 - Sullivan Mounted 139
 - Trench Work 711
 - Table XI, of Air Feed or Cradle Mounted 113
 - Table X, of Unmounted 107
 - Test of 191
 - Hand 21
 - Hardsocg Wonder 189, 190
 - Holes
 - Diamond, Used in Mining. 363
 - Placing 467
 - Prospecting 272
 - Spacing and Charging
 - Cable Drill Holes 588
 - Hollow Piston 147
 - Holman 175, 189, 190
 - Ingersoll-Leyner 136
 - Jumper 21
 - Jumper—for Submarine Work 727
 - Jumper—with Power Attachment 728
 - Kid 189, 190
 - Kimber 189
 - Leyner-Ingersoll, Test of Large and Small 136
 - Little David 297
 - Modern Rock 71
 - Mounting 96
 - On Scows 744
 - Column and Bar 103
 - New Century 176
 - Panama Canal 675
 - Percussive
 - Air and Steam, Tables. 77
 - Air Consumption 214, 217
 - Cost of Operating 6-Drill Plant 180
 - Daily Operating Costs. 180
 - Handling on Tripod 98
 - Electric 149
 - Parts of 78
 - Repairs and Renewals 184
 - Quarry Work 588
 - Size of, Tables VII to IX. 85
 - Platform, Portable for Subaqueous Work 765
 - Pneumelectric 153
 - Portable Boiler and—for Trench Work 716
 - Repairs—Hammer and Percussive 187
 - Repairs and Renewals, Bureau of Mines Report 187
 - Percussive 184
 - Washington Tunnel Works 185
 - Rice Gasoline 158
 - Rig, Auto traction 147
 - Rotary 21
 - Rotary Auger 297
 - Rotary Well 310
- Drill**
- Scott Gasoline 155
 - Scott Gasoline, parts 156
 - Scows, see also Drill Boat. 733
 - Detroit River 743
 - N. Y. Harbor 759
 - Sharpener 762
 - Sharpening Costs 29
 - See Drill Bits, Sharpening.
 - Shot 379
 - Calyx Outfit Complete 392
 - Davis Cutter 381
 - Double Core Barrel 381
 - McKiernan Terry Parts 382
 - McKiernan Terry, Sizes and Capacities 380
 - Operating Directions 382
 - Sizes of 350
 - Siskol 175
 - Steam Boiler Capacity 234
 - Consumption 223
 - Steam or Air, Size of 84
 - Steel for Subaqueous 745
 - Subaqueous 725, 728, 733, 745
 - Mountings 744
 - Mounted on Guide Posts. 771
 - Churn—at Sidney 772
 - Standard 725
 - Sullivan F. P. 33 Engine
 - Feed 83
 - Testing Machine Drill 208
 - Traction Rock 141
 - Valves 72
 - Wagon, Electric-Air 204
 - Wagons in Quarry Work 588
 - Wagon Rigs for Deep Holes. 145
 - Well
 - Advantages in Blast Hole Drilling 265
 - Cost 253
 - Percussion Types 252
 - Portable Rigs 256
 - Star—Sizes 257
 - Use of Machines 231
- Drilling**
- Items pertaining to the operation, maintenance, etc., of Drills are under *Drilling*, items pertaining to Drills, Parts, Mountings, Accessories, etc., will be found under *Drill*.
- Drilling**
- Air—on Chicago Canal 669
 - Air Consumption at Rose Deep Mine 217
 - Air Pressure Determination. 168
 - Air Required for 218
 - Air, Steam and Hand Compared 710
 - Auto-Traction 141-147
 - Blast Holes with Augers. 35
 - Blockhole 639
 - Block Holes, Hand 640
 - Block Holes—Hand vs. Machine 644
 - Block Holes, Mounted Piston Drills 640

- Drilling**
- Block Holes, with Plug Drills 640
 - Cable and Rotary Speeds and Costs 322
 - Cable and Rotary Compared 317
 - Cable and Rotary Costs Compared 319
 - Cable and Tripod Percussive Compared 267
 - Cable, see also Drilling, Prospect.
 - Caving in Hole 293
 - Cost Analysis 282, 288
 - Copper Porphyry 270
 - Crooked Holes 286
 - Deep Wells in California 303
 - Deflection of Holes from Vertical 293
 - Fishing for Lost Tools 294
 - Limestone Quarry 270, 591
 - Mining Copper Ore 270
 - New Mexico Costs, Table XXXVI 289
 - New York, Westchester County 271
 - Prospecting, see also Drilling, Prospect.
 - Prospecting in Arizona 274, 291
 - Prospecting in California 270
 - Prospecting Costs 272, 284, 290
 - Prospecting in New Mexico 273
 - Quarry Work in Ohio 269
 - Ry. Cut 633
 - Setting Up and Assembling 259
 - Speed 261, 322
 - Speed in Basaltic Rocks 269
 - Speeds on Penna. R. R. 266
 - Time Table of 20 Months 290
 - Traction Advantages 256
 - Walking Beam 261
 - Water Supply 291
 - Churn and Air Hammer Compared 192
 - Blast Holes in Iron Ore of
 - Mesabi 35
 - Gneiss 34
 - Granite 34
 - Hand 626
 - Hornblende 34
 - Limestone 34
 - Quartz 34
 - Sandstone 34
 - Coal Consumption 181
 - Collar Pipe for 139
 - Concrete with Shot Drill 389
 - Contest in Colorado 170
 - Core, see Diamond and Shot.
 - Diamond and Shot Costs Compared in Nova Scotia 389
 - Costs, Subdivided 739
 - Culebra Cut 674
 - Diamond
 - Air Instead of Water, Use of 334
 - Alaska 363
 - And Shot Drilling Compared 389
- Drilling, Diamond**
- Ashokan Dam Site 394
 - Bortz, Costs 332
 - Brejcha System 372
 - British Columbia 354
 - Caliper for Holes 346
 - Canada, Cost and Speed 353
 - Carbon Costs 332
 - Carbon and Bortz, Adaptability 332
 - Carbon Consumption, Low Cost 333
 - Carbons Required 329, 331
 - Colorado Coal 356
 - Cost Compared to Wash Boring 369
 - Croton Aqueduct 360
 - Deep Sea Method 367
 - Diamond Consumption 329, 331
 - Diamond Consumption, Table XXXVIII 332
 - Diamond Setting 330
 - Divergence of Holes 338
 - Electric Light Method of Surveying Bore Hole 342
 - General Conclusions 397
 - Hand—In Arizona 365
 - Hydraulic Feed 395
 - Lake Superior Copper Country 365
 - Lehigh Valley 360
 - Minn. 361
 - Mesabi District 367
 - Michigan 362
 - Minnesota 362
 - Moving and Setting up Outfit 337
 - New York City 370
 - Operating Instructions 358
 - Prospecting for Coal 358
 - Screw Feed 395
 - Speed Factors, Table XXXIX 346
 - Speed and Progress 357
 - Surveying the Bore Hole by: Hydrofluoric Acid Method, 340; Electric Light Method, 342; Azi-clinometer, 343; Gelatin Method, 346; Calipers 346
 - Tests of Bore Holes 398
 - Time Lost in—Operations 349
 - Time Studies 350
 - Virginia 348
 - Water Required 334
 - World's Deepest Bores 371
 - Electric
 - Costs 195
 - Gardner Drills 197
 - Siemens-Hulске in Germany 196
 - Electric-air 199, 203, 204
 - Estimating Feet per Shift 177
 - Flint Rock 762
 - Hammer 24
 - And Percussive Contest 188
 - Costs 25, 26, 27

- Drilling, Hammer**
 New York 194
 One Hand vs. Two Hand. . . 24
 Portable Compressor Costs 193
Hand and Machine
 Comparative Costs 31, 602
 Mining in Transvaal. 33
 Roosevelt Dam 34
Hand
 Block Holes 640
 Canadian Pacific Ry. Work . . 32
 Churn 626
 Grand Trunk Pacific Ry. . . . 28
 Granite 29, 614
 Panama Canal 675
 Sandstone and Shale. 624
 Sewer Work 710
 Speed 32, 34
 Steam, Hand and Air Com-
 pared 710
 Subaqueous 774
 Trimming Sides of Rock
 Cut 36
 Tunnel Work 28
 "Hole Contract" System of
 Payment 206
Horizontal Holes 50 Feet
 Long 780
 Leyner Ingersoll Test. 217
 Machine and Hand Com-
 pared 602
 Machine—in Granite 614
 Machine, Speed 165
 Mica Schist, Side Hill Cut. . . 622
 Oil Well Methods in Cali-
 fornia 303
 Operating—Costs of 1 and 2
 Drill Plants 181
 Operating Costs for 12 Drill
 Plant 182
 Ore at North Star Mines. . . . 208
 Panama Cost Summary. 617
 Panama Costs 683
Percussive
 Change of Steel. 162
 Cost Factors 160
 Setting up Column. 163
 Shifting from Hole to Hole
 Time for Vertical Holes. . . . 164
 Time Lost in. 161
Plug 77
Plug Holes 542
Plug Holes by Hand, Cost. . . 543
Pneumatic Plug, Cost. 544
Pneumatic Drill 204
Portable Plant 713
Prospect—See also Drilling,
Cable, Core, Diamond,
Rotary, Shot and Well.
 Accuracy of Sampling. 295
 Arizona 278
 Cable Work in Arizona. 290
 Cost of Cable Work. 296
 Missouri 275
 Montana 277
 Nevada 275
 New Mexico 277, 284
 Sampling 294
- Drilling**
 Shot Drilling for Coal. 357
 With Well Machines. 279
 Quarry in Oklahoma. 173
 Quarry in Panama. 172
 Quarry in Vermont. 191
Rotary
 And Cable Compared. 317
 And Cable Costs Compared . . 319
 And Cable Speeds 322
 Deep Hole Costs 324
 Equipment Cost 324
 Fishtail Bit 315
 Sharp and Hughes Cone
 Bit 316
 Speed 322
 Well 297
 Sampling Prospect Holes. . . . 294
Shot Drilling
 And Diamond Drilling
 Compared 359
 And Wash Boring Com-
 pared 390
 Boulders 383
 Broken Rock 385
 Concrete 389
 Cores 6" Diameter 391
 New York City. 385
 Prospecting for Coal. 387
 Removing Core 384
 Seams of Broken Rock. 385
 Shot Required 379
 Speed and Cost 381
 Terry Drill in New Jersey . . . 386
 Water Bearing Seams. 384
 Speed, Average 179
Speed Contest between Ley-
ner, Sullivan and Inger-
soll 171
Speed, Effect of Air Pres-
sure 222
Speed in Different Rocks 164,
165
Speed per Shift, Estimating. . . 177
Steam, Air and Hand Com-
pared 710
Stripping Iron Ore 602
Subaqueous Drilling 724,
 And Breaking Compared. . . . 787
 Alnapee Harbor, Wis. 755
 Ashtabula Harbor. 756
 Ashtabula Costs. 758
 Black Tom Reef. 776
 Boulders, Wood's Hole,
 Mass., Buffalo, Black
 Rock Harbor. 778
 Brisbane River. 767
 Costs 739, 747
 Eagle Harbor, Mich. 775
 Compared to Lobnitz
 Breaking 788
 Ejector 776
 Hand Work, Australia. 774
 Hand Work, England. 773
 Hell Gate 778
 Hurricane (Drill Boat). 741
 Malta 792
 Melbourne. 771
 Mississippi River. 799

Drilling, Subaqueous		
New York Harbor	759	
Platform for	759	
Pile Driver	768	
Platform on Tripod	802	
Portable Platform	766	
Portsmouth Navy Yard	779	
St. Lawrence River	754	
Sand Tube	746, 764	
San Francisco Harbor	777	
Tennessee River	760	
Time of	752	
Way's Reef, N. Y. Harbor	777	
Welland Canal	753	
Test Holes	297	
Theory of Hammer and Churn	21	
Times and Speeds in Trench Work	717	
Time and Speed for Well Holes, Table XXXV	284	
Time of Operations, Table XIV	169	
Time Study	166	
Time Study on Gordon Hammer Drill	189	
Timing—Processes	166	
Traction—Outfit	713	
Transval Stope Competition	174	
Trap Rock in Trench Work	708	
Trench Work	770	
Tripod Percussive and Cable—Cost Compared	268	
Wagon—Rigs for Deep Holes	145	
Water Jet in	166	
Well, see also Cable	252	
Cable Methods in California	303	
Deep Holes	323	
Hollow Rod Method	255, 323	
Machines, Cost	253	
Operating—Machines	256	
Pole Tool Method	255	
Power	253	
Prospecting in Arizona, Montana and New Mexico	277	
Prospecting in Nevada and Missouri	275	
Rotary Rig	297	
Speed	261	
West Neebish Channel	559, 700	
Drys	6	
Dualin	411	
Dulles-Baldwin Drill	150	
Cost of Drilling with	195	
Dump Cart, see Cart		
Dumping Costs at Panama	683	
Dust Collectors	135	
Dust, Water Spray to Allay	135	
Dynamite	405	
See also explosives.		
Ammonia	410	
And Nitroglycerin	405	
Charges for Boulder Blasting	637	
Charging and Priming	443	
Composition	407	
Dynamite		
Cost at Panama	436	
Detonating	457	
Dope	407	
Explosive Action Compared to Powder	403	
Frozen, Efficiency of	432	
Gelatin	410	
Grades of	407	
Grade to use, how to Determine	439	
Low Freezing, Table XLVIII	409	
Magazine, Cost of	430	
Magazine, Iron	429	
Magazine, Panama	676	
Magazine, Specifications	430	
Misfires by Ignition	446	
Priming and Charging	443	
Quantities Used in Submarine Work	726	
Safe Storage Distances from Buildings, Table LIII	429	
Safety Tests	433	
Storage and Handling	423	
Strength Tests with Lead Blocks	433	
Tests—Abel Block	457	
Tests—Lead Block	433	
Thawing	418, 420	
Thawing Kettles	422	
Varieties of	409	
Weight of	412	
Earth and Rock Handled Together	631	
Earth, Loose Rock and Solid Rock Classified	17	
Efficiency, Drill, Testing at North Star Mines, Cal.	207	
Efficiency of Power Plants	211	
Efficiency of Steam Boilers	232	
Efficiency of Steam Pipe Line	224	
Electric Air Pulsator Drill	69, 151	
Electric Cap	458	
Electric Detonator	458	
Electric Drills	148	
Engines, Efficiency of	212	
Excavating—Look under heading of kind of equipment used and kind of material excavated, also look under kind of work as open cut, railroad cut, etc.		
Excavation		
Canal, see also Canal	648	
Cost, depending on depth of cut	634	
N. Y. Barge Canal, Lock No. 5	703	
Panama, Culebra Cut	682	
Railroad Cut Costs	609	
Excavator		
Bishop Derrick	506	
Conveyor on Barge Canal, N. Y.	701	

Explosion, Gases from.....	402	Gneiss	
Explosives, see also various names, as: Dynamite, Powder, etc.....	793	Excavating for Dams.....	605
Explosives		Grain.....	6
Chicago Canal.....	669	Granite.....	7
Detroit River Work.....	741	Excavating in Open Cuts, on Grand Trunk Pacific....	613
Energy of—Table I.V.....	438	Quarrying.....	572
Force of different.....	439	Quarrying at Barre, Vt.....	574
Gelatin.....	434	Quarrying Costs.....	579
Hell Gate.....	779	Quarrying Massive.....	577
Kind to use.....	437	Splitting by Compressed Air Trench Excavation.....	578
Moisture, Effect of.....	424	Gravity Inclined Plane Endless Rope.....	533
Panama Canal.....	675	Greenstone.....	5
Per cu. yd. of rock.....	618, 620, 622	Groundmass.....	5
Permissible.....	415	Grouting Shafts in Diamond Drilling.....	372
Prices.....	626	Hammer Drills, also see Drills, Hammer.....	74
Prices in England.....	774	Hammer Drill, Mounted.....	69
Railroad Cut Costs.....	610	Hammer Drilling.....	24
Selection of.....	439	Handling Crushed Stone, Cost.....	509
Storing at Panama.....	676	Hardness of Rock.....	2
Strength Table.....	408	Hardpan	
Subaqueous Work.....	732, 734, 774	Blasting.....	492-495
Tests of.....	435	Excavating.....	649
Ballistic Pendulum, Bichel		Subaqueous—Excavation.....	738
Pressure Gauge, Trunzle		Hauling	
Lead Blocks, Small Lead		Cars.....	609
Blocks, Meltegard Re-		Cars with Horses.....	520
recorder and Detonating		Cars with Locomotive, Cost.....	516
Fuse		Cart Costs.....	525
Transportation.....	431	Carts and Wagons, Costs in.....	523
Weight in lb. per ft. of hole.....	415	Railroad Cut Costs.....	610
Firing by Electricity.....	447	Stone Boats.....	517
By Light or Power Cur-		Teams and Traction Engine	
rent.....	451	Costs Compared.....	526
Methods.....	454	Wagon Costs.....	524
Subaqueous Charges.....	765	Wheelbarrow Cost.....	516
Fish Pole Mounting.....	121	Wheelbarrows.....	609
Flagstone.....	6	Head (plane of cleavage).....	6
Forcite.....	412	Heat Energy.....	211
Forges, Fuel for.....	59	Heating Boulders to Break.....	646
Fort Wayne Electric Drill.....	151, 197	Hercules.....	411
Freestone.....	6	High Center Bit.....	38, 41, 46
Fuel for Forges.....	59	Hoist, Air—on Chicago Canal	653
Fulminate of Mercury.....	414, 456	Holes	
Fuses, "Delay".....	448	Arrangement for Effective	
Fuse, Safety.....	455	Blasting.....	469
Fuse Wires, Splicing.....	449	Arrangement for Side Hill	
Gabbro.....	8	Blasting.....	622
Gad for Splitting Rock.....	627	Cable Drill, Depth.....	292
Gadder.....	49, 97	Cable Drill, Loading and	
Gardner Electric Drill.....	149	Tamping.....	590
Gases from Explosion.....	402	Charging in Trench Work.....	706
Gasoline Air Compressor.....	247, 711	Coyote.....	487
Gasoline Drill.....	69, 155	Position in Blasting.....	470
Gelatin, Blasting.....	413	"Relief"—in Tunneling.....	470
Gelatin, Explosive.....	434	St. Louis Sewer.....	729
Gelatin Method of Surveying		Sandstone and Shale.....	623
Diamond Drill Holes.....	316	Size of—Effect on Speed of	
Gelignite.....	111	Drilling.....	32
Geological Classification of		Spacing.....	607
Rock.....	1	Spacing, Table LXVII (cu. yds. broken for different spacing).....	585
Geraldine Double Boom Der-			
rick.....	660		
Giant Powder No. 2.....	411		
Gneiss.....	7		
Excavating Cost.....	604		

Holes		Loading—See charging when referring to loading blasts	
Spacing and Charging Cable		Loading Rock, see also Shovels, Steam, etc.	510
Drill	589	Loading Rock	
Spacing on Chicago Canal	658	And Transporting	501
Spacing in Open Cuts	584	Difference between Hard and Soft Rock	506
Spacing at Panama	670	Hand Costs	501
Spacing in Subaqueous Work, Table LXXXI	734	Hand Costs at Panama	683
Spacing in Trench Work	718	Steam Shovel Costs	506
Springing	471	Lobnitz Rock Breaker	724, 781
Springing	615	Lock Excavation on Panama Canal	673
Submarine Requirements	732	Lock No. 5, N. Y. Barge Canal	703
"Hole Contract" System of Payment	206	Locke Drill	119
Hollow Bit for Ejecting Sludge	44	Locomotives	
Holman Drill	175	Culebra Cut	681
Horse Power Defined	211	Panama Canal	671
Horsley Powder	411	Loose rock, solid rock and earth, Classified	17
Hose, Flexible Metal	229	Los Angeles Aqueduct, Over-breakage	16, 692
Hullet-McMyler Conveyor Crane	658	Shovel, Electric	694
Derrick	659	Shovel, Steam	693
Hydraulic Excavation of earth, broken rock, etc.	699	Lug Drill Steel	45
Hydraulic Hoist for Drills	751	Macadam, Quarrying Trap for	592
Hydrofluoric Acid Method for Surveying Diamond Drill Holes	340	Manure in Thawing Dynamite	21
Igneous Rock Species	3	Marble	10
Inclination of Hole, effect upon speed of drilling	23	Block 23 x 13 x 5, Channeled	570
Incline for conveying Rock Spoil	651	Quarrying Method	566
Incline Hoist for Cars	664	Quarrying at Phenix, Mo.	567
Incline Plane, Endless Rope Gravity	533	Mt. Blasting	706
Ingersoll-Leyner Sharpener	58	Measurement of Rock	14, 501
Ingersoll-Leyner Water Drill	217	Mercury Fulminate	414, 456
Inspection of Borings	396	Metal Hose, flexible	229
International Ry. Congress 1910 Bulletin	31	Metamorphic Rock Species	3
Iron Mine, Stripping	602	Methods and Costs—This phrase is understood to apply to every item in the index except where it is obvious that these facts do not enter	
Iron Ore Excavating	595	Mica Schist Excavation	621
Iron Ore Mining, Mesabi District	599	Miners' Squibs	455
Jackhammer	69	Mining, Pit	594, 597
Jet, combined air and water, for Sludge removal	132	Mistres	457
Jets, Water, in Drilling	123	Mounting	
Joints in Rock	4	Cradle or Shell for Air Hammers	122
Joints in Stone	540	Fish Pole for Air Hammers	121
Judson Giant Powder	412, 413	Mud Capping	636
Knox Blasting	562, 571	Mud Laden Fluid in Well Drilling	306
Lackawanna and Wyoming Valley R. R., Scranton Tunnel Overbreakage	16	"Mudding" Difficulties	64
Leyner-Ingersoll Drill	136, 170	"Mudding" Properties of Drill Bit	40
Limestone, Crushing	593	Mules, Maintenance Costs	625
Limestone	10	New Century Drill	176
Drilling with Cable Drill	591	Niggerhead	6
Quarrying	581, 593	Nitroglycerin and Dynamite	405
Lisparite	7	Norite	8
Lithofracteur	412	Oil Well Drilling in California	303
		Open Cut, see also Railroad Cut	612

- Open Cut Excavation
 Cost Summaries..... 636
 General Considerations... 583
 Granite 613
 Height of Bench 584
 Quarries, Pits and Mines.. 583
 Spacing Holes 584
 Overbreakage 15, 636
 On Norfolk & Western R. R.
 Work, Prices..... 16
 Panama Canal, see Canal.... 67
 Percussive Drills, see Drills,
 Percussive
 Percussive Drill Bits, see Drill
 Bits
 Pipe Covering 225
 Cost of 227
 Pipe Lines for Compressed Air 228
 Pipe Line, Steam
 Efficiency of 224
 Size of 226
 Pit Mining
 Brewster, N. Y..... 594
 Rochester, N. Y..... 597
 Platform
 Portable Drill 765
 Subaqueous Excavation... 724
 Platinum Fuse 458
 "Plucky" Stone 6
 Plug and Feathers..... 541
 Plug Drilling, see Drilling.
 Plugger Drill 69
 Pneumatic Tool 76
 Pneumatic Drill..... 69, 153
 Drilling with 204
 Pole Tracks for Stone Boats.. 518
 Porphyry 5, 7
 Powder
 Black 404
 Cartridge for wet holes... 442
 Charging 441
 Contractor's 413
 Explosive Effect Compared to
 Dynamite 403
 Judson 413
 Judson, charging 447
 Properties of Good Black... 405
 Trojan 414
 Power Drills, Classification
 Power Plants
 Efficiency of 211
 Panama Canal 686
 Repairs and Depreciation. 250
 Power required for Air Com-
 pression 213
 Potassium Nitrate 456
 Pressure Tests of Bore Holes. 398
 Primer, Position in Blast Hole 447
 Priming 449
 Prospect Drilling, see Drilling,
 Prospect; also Drilling,
 Cable
 Prospecting 696
 Pump for Water Jet 129
 Pump Steel for Sludge removal 143
 Purser's Dust Collector..... 135
 Quarry Bar 47, 97
 Quarry Water 6
 Quarrying
 Buffalo Breakwater, Costs... 563
 Cable Drill Holes 586
 Dimension Stone 539
 Drill Wagons in 588
 Gneiss, Cost 580
 Granite... 572, 574, 577, 579, 572
 Granite, Costs 579
 Granite, Massive 577
 Granite, Splitting by Com-
 pressed Air 578
 Hammer Drilling 545
 Limestone 593
 Limestone, Costs 581
 Marble, Methods 566
 Marble at Phenix, Mo. 567
 Marble, by Tunnel Method.. 569
 Opening Vermont Quarry... 568
 Panama Canal Work..... 689
 Sandstone 571, 581
 Sandstone, Dimension..... 571
 Trap for Macadam 592
 Water Cushion Blasts..... 572
 Quarrymen's Terms..... 6
 Quartzite 9
 Rackrock 414
 Railroad
 Blasts, Large 633, 634
 Excavation 607, 609, 612, 620, 624
 Excavation Costs—Table. 609, 612
 Granite Excavation 613
 Open Cut Excavation 630
 Side Hill Cuts 621
 Tunnel Approaches 623
 Reciprocating Drill 69
 Reheater—Air 713
 "Relief Holes" 469
 Removal of Sludge from Holes. 45
 Removal of Submarine Rock... 724
 Removing Rock from Trenches 709
 Rendrock 410
 Repair Shops, Panama Canal.. 687
 Repairs—See item required, as:
 Drill repairs, Cableway
 repairs, etc.
 Repairs and Depreciation of
 Power Plants 250
 Repair Costs at Panama..... 688
 Rift 6
 Riprap—Measurement of... 15
 Roads for Prospect Drilling. 291
 Rock and Earth, Classified for
 Excavation Prices 17
 Rock and Earth handled to-
 gether 631
 Rock Breaker; see Breaker... 781
 Rock Classifications 608
 Rock, Classifications for Excava-
 tion 625
 Rock Excavation, Cost depend-
 ing on depth of Cut..... 634
 Rock Forming Minerals..... 1
 Rock
 Hardness of 2
 Joints in 4
 Loading and Transporting... 501

- Rock**
 Measure 14, 501
 Removing from Trenches.... 709
 Seaminess of, Test..... 304
 Species:
 Igneous, Aqueous, Meta-
 morphic 3
 Spoil Disposal at Panama... 681
 Toughness of 439
- Rotary**
 Air Drills 297
 Auger Drills 297
 Steam-Driven Augers..... 68
 Well Drill 310
 Rotation Systems..... 84
 Round Edge Bit..... 42
 Rosette-Bit, six wing..... 42
- Safety Fuse** 455
Sampling 287, 294
**Sand Pipe for Subaqueous
 Drilling** 746
Sandstone 8
 Excavation in Penna..... 623
 "Medina" 9
 Ohio 9
 Pennsylvania 9
 "Potsdam" 9
 Quarrying Cost 581
 Quarrying Dimension..... 571
- Sap** 6
Scale Pan or Skip..... 505
Setting Diamonds, see Diamonds
 Brejcha System 381
Settlement of crushed stone... 15
Sewer, see also Trench Work
Sewer, Excavated by Hand
 Drills 710
Sewer Cable Way..... 536
Sewer Trenches 709
Shaft Sinking
 Handling Drills in 122
Shale, Excavation in Penna. 9, 623
 Sharpening Drill Bits, also see
 Drill Bits 50
 Sharpening Hand Drills, Costs. 29
- Shovel, Electric**
 Los Angeles Aqueduct.... 692
 Operating Cost 515
- Shovel, Steam**
 Chicago Canal Outputs... 669
 Chicago Canal Work.... 650
 Clay and Granite Costs... 628
 Cutting Side Hill..... 698
 Granite and Clay Costs... 628
 Gravel and Boulder Costs. 513
 Iron Ore, Output..... 509
 Iron Ore Work..... 600
 Loading Cars 629
 Loading Costs 506
 Long Beam for Sidehill
 Cut 698
 Los Angeles Aqueduct.... 692
 Maintenance at Panama.. 679
 Mica Schist 507
 Operating Cost 624
 Panama Canal..... 671, 677
- Shovel, Steam**
 Panama Costs..... 683
 Panama Locks..... 673
 Prices 505
 Ry. Work, Output..... 632
 Sandstone and Shale... 508
 Shale Costs..... 508, 513
 Slate Costs 512
 Small—in Quarry Work.. 509
 Two Shovel Method of Side
 Hill Cutting..... 697
 Signal System for Cable Way
 529, 532
 Simens-Schneekert Drill..... 149
 Simmons Bit, the..... 41
 Siskol Drill 175
 Size of Hole, Effect upon
 Speed of Drilling 22
 Skip or Scale Pan 505
 Slate 9
 Sledging Boulders 641
 See Boulders, Breaking
 Slides at Panama 684
 Sludge Agitator or Wash-Out.. 140
 Sludge Pump 140
 Sludge Removal 45
 Pump Steels for..... 143
 Water Jets 124
 Water Jets, Cost of..... 130
 Water under Pressure, or
 Jet 217
 Water with Air..... 132
 Smeaton Diving Bell..... 729
 Snakeholing 636
 Solid rock, loose rock and earth,
 Classified 17
 Spacing Cable Drill Holes.... 589
 Spacing of Drill Holes..... 607
 Table LXVII, showing cu.
 yds. broken per ft. of
 hole, for different spacing 585
 Specific Gravity of Rock..... 11
 Specific Gravity—Table I.... 12
 Specific Gravity and Weights
 per cu. ft. and cu. yd.—
 Table II 13
 Specifications for Classifying
 Excavated Materials.... 17
 Splicing Fuse Wires..... 449
 Spray of Water to allay dust. 135
 Springing Holes 471
 Spudding 259, 291, 381
 Spuds on Drill Scows..... 744
 Squibs, Miners 455
 Stalactites 10
 Stalagmites 10
 Star Well Drill Sizes..... 257
 Steam Boiler Efficiency..... 232
 Steam Consumption in terms of
 Air Consumption 223
 Steam Drill, see also Drill... 68
 Steam Pipe Covering and Cost
 225, 227
 Steam Pipe Line Efficiency... 224
 Steam Shovels, see Shovels
 Steam
 Table XXV, Losses through
 bare iron pipe..... 224

Steam, Table XVII. Vol. and temp. at given pressures	214	Telescopic Air Feed	121
Steel for Drill Bits, grades of	53	Tempering Drill Bits	52
Stock (quarrymen's term)	7	Temple-Ingersoll Drill	151
Stone Boats	517	Test Holes, Drilling Cost	297
Stone, Crushed		Testing Drills	208
Cost of handling	503	Thawing Dynamite	418
Panama Canal	688	Thorough Cut	208
Unloading and Hauling	525	Through Cut	623
Stone, Dimension		Time Studies	
Joints in	540	Drilling	166
Quarrying	539	Drilling, Cable	279, 280
Stonite	411	Diamond Drilling	350
Stoper	69	Tipple, Rock Spoil	651
Stretcher Bar	96	Tender for Drill Float	763
Stripping Iron Ore	35, 602	Track	
Subaqueous—Look under detailed heading, such as		Chicago Canal Layout	651
Drilling, Blasting, etc.		Handling Costs	632
Subaqueous Drills		Panama Costs	683
Table LXXXI	736	Panama Canal, Culebra Cut	680
Subaqueous Excavation	723	Traction Engines	
Ahnapee Harbor, Wis.	755	Hauling Costs Compared to Team Costs	526
Ashtabula Harbor	756	Traction Rock Drill, see Auto Traction	141
Brisbane River	767	Transportation, see Hauling.	
Buffalo	748	Costs at Panama	680, 683
Chisel and Dredge	799	Transporting and Loading	
Cofferdam and Drilling	799	Rock	501
Costs by various means—		Transvaal Stope Competition	174
Table LXXXVII	803	Trap Rock	5, 7, 593
Detroit River Excavation		Travertine	10
Costs	732	Trench	
Drill Boat, Blasting and Dredging	799	Granite Excavation	72
Eagle Harbor	775	Sewer—Hammer Drills in	712
Hardpan and Clay	738	Rock Excavation in St. Louis	717
Holes and Explosives required	732	Trench Work	705, 709
Loading Rock — Table		Look under detail subdivisions, like Drilling, Blasting, etc.	
LXI	510	Trestles for Spoil Fill at Panama	629, 682
Melbourne	771	Trimming and Dressing	609
Mississippi River	749	Trojan Powder	414
New York Harbor	776	Trucking, see Hauling	
N. Y. Harbor, high cost	759	Tripod	96
Oswego, N. Y.	751	Tug, Operating Cost	750
Rock, Removal of	723, 725	Tunnel Column	96
Subcontracting to gangs of "station men"	613	Tunnel	
Sullivan F. P. 33 Engine Feed Drill	83	Compared to open Cut as to Drilling	23
Sullivan Sharpener	57	Drilling Costs	27, 28, 31
Superintendence Costs at Panama	683	Overbreakage	16, 17
Surveying Diamond Drill Holes	340	Types of Power Drills	68
Surveys, Cost at Panama	683		
"Swell" of Rock upon breaking up	12	Undermining Boulders, see Boulders, Breaking	
Switchback for Hill	632	Undermining Flood Rock, Hell Gate	778
Syenite	7	Union Pacific R. R.	
		Overbreakage on Tunnel Work	16
Trimming Side of Rock Cut by Hand Drilling	36	U. S. Reclamation Service	
Tamping	446	North Fork Tunnel	16
Clay Plugs for	417	Unloading and hauling Crushed Stone	525
Teaming, see Hauling		Unloading Equipment, Panama	682
Teams, Hauling Costs Compared to Traction Engines	526	Unloading Rock	502
		Unloading Stone from Scow	502

INDEX

825

Valves, Types of Drill.....	83	Weight of rock affected by	
V-Bit	63	Moisture	13
Veins	5	Weights and Voids in Rock...	10
Vigorite	411	Weights of Rock per cu. ft. and	
Voids and Weights of Rock...	10	cu. yd.	13
Voids in Rock blasted under		Well, Artesian	290
Water	13	Well Casing	303
Vulcanite	412	Well Drilling.....	297
		See Drilling, Well	
Wagons		Welland Canal.....	753
Hauling in	523	Wheelbarrow Hauling.....	516
Hauling Costs	524	Wiring Methods.....	450
Hauling Crushed Stone.....	525		
Wash Borings, Cost Compared		X-Bit	41
to Shot Drilling.....	390	Y-Bit	42
Water in Hole, Hand Drilling.	23	Z-Bit	42
Water Jet in Drilling.....	123, 166		
Water Spray to allay dust.....	135		



ENGINEERING AND TECHNICAL BOOKS

The Clark Book Co., Inc., will be pleased to send you any of the following books or sets of books for ten days' examination,

PREPAID AND WITHOUT OBLIGATION

(Reference or membership in engineering society required, or in lieu of this a check for the amount involved, which will not be deposited, or cashed unless you purchase the books. Otherwise the check will be returned to you when you return the books in undamaged condition.)

COMPLETE SETS AT REDUCED PRICES

may be had on terms of \$3 down and \$3 per month. In addition to the sets noted below, we will be glad to quote special discounts on any combination of three or more books desired.

COSTS AND EQUIPMENT

Gillette's — "Cost Data" (All civil engineering)	\$ 5.00
Gillette's — "Handbook of Rock Excavation, Methods and Cost"	5.00
Gillette's — "Handbook of Earth Excavation, Methods and Cost," Ready in Jan., 1917	5.00
Dana's — "Handbook of Construction Plant"	5.00
Gillette & Dana — "Cost Keeping and Management Engineering"	3.50

STRUCTURAL ENGINEERING

Kirkham — "Structural Engineering"	5.00
Malcolm — "Graphic Statics"	3.00
Steinman — "Melan's Steel Arches and Suspension Bridges"	3.00
Tyrrell — "Mill Buildings"	4.00
Tyrrell — "Artistic Bridge Design"	3.00
Wells — "Steel Bridge Designing"	2.50

BUILDING WORK

Walker's — "Building Estimator's Reference Book"	10.00
Gilbreth — "Field System"	3.00
Gilbreth — "Bricklaying System"	3.00

CONCRETE

Cochran — "Inspection of Concrete Construction"	4.00
Dodge's — "Diagrams for the Design of Reinforced Concrete"	4.00
Gillette & Hill — "Concrete Construction, Methods and Cost"	5.00
Heidenreich's — "Engineer's Pocketbook of Reinforced Concrete"	3.00
Reid — "Concrete and Reinforced Concrete Construction"	5.00
Reuterdaahl — "Theory and Design of Reinforced Concrete Arches"	2.00
Taylor's — "Practical Cement Testing"	3.00
Tyrrell — "Concrete Bridges and Culverts"	3.00

RAILWAY WORK

Lovell's — "Practical Switchwork"	1.00
Smith — "Maintenance of Way Standards"	1.50
Smith — "Standard Turnouts"	1.00
Kindelan's — "Trackman's Helper," revised by Dana and Trimble. Ready in Oct., 1916	2.00

MISCELLANEOUS

Robinson's — "Military Preparedness and the Engineer"	1.50
Frye's — "Civil Engineers' Pocketbook"	5.00
Haring — "Law of Contract"	4.00
Taylor's — "Surveyor's Handbook"	2.00
Taylor's — "Backbone of Perspective"	1.00
Parsons — "Land Drainage"	1.50
Mayer's Telephone Construction	3.00

COMPLETE SETS

Cost Data, Construction Plant, Cost Keeping	12.00
Structural Engineering, Graphic Statics, Mill Buildings, Steel Bridge Designing	12.00
Inspection of Concrete, Gillette & Hill's Concrete Methods and Costs, Reid's Concrete Construction	12.00

CLARK BOOK CO., INC., 27 William Street, New York City

HANDBOOK OF COST DATA

By Halbert P. Gillette, Consulting Engineer, Mem. Am. Soc. C. E.,
Am. Inst. Mech. Eng.

Handbook binding, 4% x7 inches\$5.00
Eighteen hundred pages of costs, not prices. Almost every conceivable civil engineering operation, from cement sidewalks to railroad systems, divided as follows:

Subjects

Principles of engineering economics; earth excavation; rock excavation, quarrying and crushing; roads, pavements and walks; stone masonry; concrete and reinforced concrete construction; water works; sewers; timber work; buildings; railways; bridges and culverts; steel and iron construction; engineering and surveys; miscellaneous cost data.

The value of the book lies in the fact that the conditions surrounding each operation on which costs are reported are so completely described that the costs may be accurately translated into terms of the same operation under other conditions.

The sale of this book exceeds, we believe, that of any other engineering work.

Cement Age: "Systems of cost keeping are described in the first part of the book, which contractors will find valuable."

The National Builder: "Mr. Gillette does not seem to have overlooked a single item in the contracting world, where costs and time are factors in making up an estimate."

Railway Age Gazette: "The author was a practicing engineer and contractor for nearly twenty years before he prepared the first edition, so the reader may feel that the book is not the work of an office man."

Canadian Engineer: "It is safe to say that on any question on which the engineer requires costs, they may be found in this book."

THE TRACKMAN'S HELPER

By F. Kindelan

Revised by R. T. Dana and A. F. Trimble

Ready in Oct., 1916

Handbook size and binding\$2.00

Written to help the man on the track, by giving him the results of observation and study of track work on the railroads of the United States for the last twenty years.

Contents: I, Construction; II, Spiking and Gaging; III, General Spring Work; IV, Drainage; V, Summer Track Work; VI, Cutting Weeds; VII, Ballasting; VIII, Renewal of Rails; IX, Effects of the Wave Motion of Rail on Track Rail Movements; X, General Fall Track Work; XI, Fences; XII, General Winter Work; XIII, Bucking Snow; XIV, Laying Out Curves; XV, Elevation of Curves; XVI, Lining Curves; XVII, Mountain Roads; XVIII, Frogs and Switches; XIX, Use and Care of Track Tools; XX, Tie Plates; XXI, Wrecking; XXII, General Instructions; XXIII, Miscellaneous.

HANDBOOK OF EARTH EXCAVATION, METHODS AND COST

By Halbert P. Gillette

Ready Jan. 1, 1917

Handbook size and binding, over 800 pages, illustrated.....\$5.00

A complete history and encyclopedia in modern earth moving methods, with detailed costs for the different methods and equipment used.

Chapters: Properties of Earth, Measurement and Classification, Boring and Sounding, Clearing and Grubbing, Loosening and Shoveling, Wheelbarrows, Carts, Wagons, etc., Scrapers and Graders, Cars, Steam Shovel Work, Bucket Excavation, Cableways and Conveyors, Trenching by Hand, by Machinery, Ditches and Canals, Embankments, Earth Dams and Levees, Dredging, Hydraulic Excavation, Miscellaneous.

CLARK BOOK CO., INC., 27 William Street, New York City

HANDBOOK OF CONSTRUCTION PLANT WITH APPENDIX OF PRINCIPAL MANUFACTURERS

By Richard T. Dana, Consulting Engineer, Mem. Am. Soc. C. E., Mem. A. I. M. E., Mem. Am. Soc. Eng. Contr., Mem. Gillette & Dana, Appraisal Engineers

4 3/4 x 7, Flexible Leather, 700 pages\$5.00
The only complete and impartial "catalogue" of construction equipment in existence.

Engineering Record: "Much valuable data are given as to the cost of operation of certain types of machinery—they furnish practically the first published basis for selecting machinery."

The American City: "Mr. Dana's volume gives the information most necessary to engineers in making estimates of construction costs and in executing plans."

The Excavating Engineer: "Undoubtedly the most complete handbook of construction plant ever published. Every conceivable type of machinery and equipment."

Concrete-Cement Age: "The descriptions include practically every type of equipment, as well as cost data."

Western Engineering: "... an abstract of almost every trade catalogue in existence."

Railway Review: "... presenting between two covers that which the engineer often searches through masses of trade catalogues and stacks of card index files to find."

The National Builder: "Many machines, appliances, methods and contrivances the ordinary contractor knows but little about are here fully described and illustrated."

COST KEEPING AND MANAGEMENT ENGINEERING

By H. P. Gillette, Consulting Engineer, Mem. Am. Soc. C. E., Am. Soc. M. E., and Richard T. Dana, Consulting Engineer, Mem. Am. Soc. C. E., Am. Inst. M. E., Am. Soc. Eng. Contr., Mem. Gillette & Dana, Appraisal Engineers

Cloth, 6 x 9 inches, 350 pages\$3.50
This work is to the construction engineer what Taylor's "Shop Management" and "Principles of Scientific Management" are to the shop foreman and superintendent.

The science of engineering management is just beginning to be recognized, and Gillette and Dana have done much, in this book, to forward and develop it.

Mr. Gillette is the author of the now famous "Handbook of Cost Data," and Mr. Dana is the author of the companion work, "Handbook of Construction Plant." To those familiar with these two books this insures the practical nature of "Cost Keeping and Management Engineering."

Complete Chapter Headings

I, The Ten Laws of Management; II, Rules for Securing Minimum Cost; III, Piece Rate, Bonus and Other Systems of Payment; IV, Measuring the Output of Workmen; V, Cost Keeping; VI, Office Appliances and Methods; VII, Bookkeeping for Small Contractors; VIII, Miscellaneous Cost Report Blanks and Systems of Cost Keeping.

SURVEYORS' HANDBOOK

By T. U. Taylor

Leather, 328 pages, illustrated\$2.00
Describes the instruments, their care and adjustment, and the methods practiced in making surveys of all kinds. Extensive tables are given to facilitate calculations.

Chapter Headings

Chain Surveying; Compass Surveying; Transit Survey; Calculation of Areas; Division of Land; Leveling; Topographic Survey; Railroad Survey; Earthwork; City Surveying; Plotting and Lettering; Government Surveying; Trigonometric Formulas; Tables, etc., etc.

CLARK BOOK CO., INC., 27 William Street, New York City

STRUCTURAL ENGINEERING

By **J. E. Kirkham**, Prof. Civil Engineering, Iowa State College, Consulting Bridge Engineer, Iowa Highway Commission. Formerly Designing Engineer with American Bridge Co.

Cloth, 6 x 9, 675 pages, 452 illustrations, 3 plates \$5.00

Here is a work so complete, and elementary, that almost anyone interested in practical structural work can get from it a thorough knowledge of its principles and practices.

For many years the author was required to "break in" new men in draughting and designing rooms, and this has taught him the needs of the man who requires a workable knowledge of the subject.

Nothing but elementary mathematics is presupposed. As the author says in his preface, the book was designed to be understood without the aid of a library of reference works.

There are fourteen chapters as follows: I, Preliminary; II, Structural Drafting; III, Fundamental Elements; IV, Theoretical Treatment of Beams; V, Theoretical Treatment of Columns; VI, Rivets, Pins, Rollers and Shafting; VII, Maximum Reactions; VIII, Graphic Statics; IX, Influence Lines; X, Descriptions of I-Beams and Plate Girders; XI, Design of Simple Railway Bridges; XII, Design of Simple Highway Bridges; XIII, Skew Bridges; XIV, Design of Buildings.

MELAN'S THEORY OF ARCHES AND SUSPENSION BRIDGES

Translated by **D. B. Steinman**, C. E. Ph.D., Prof. of Civil Engineering, Univ. Idaho, author of "Suspension Bridges and Cantilevers"

Cloth, 6 x 9, 310 pages, 120 illustrations \$3.00

This is a complete, authorized translation of Professor Melan's masterpiece on the theory of arches.

Contents

The Flexible Arch and the Unstiffened Cable; The Stiffened Suspension Bridge; The Arched Rib (the Three Hinged Arch, Arched Rib with End Hinges, Arched Rib without Hinges, The Cantilever Arch, the Continuous Arch); Arch and Suspension Systems with Braced Web; Combined Systems; Appendix—The Elastic Theory Applied to Masonry and Concrete Arches, Temperature Variation in Steel and Masonry Bridges.

Engineering News: "It is by far the most extensive theoretical study of this subject known to the reviewer."

Journal Western Society of Engineers: "Professor Steinman has done a great service to all English speaking engineers in translating this treatise on Arches and Suspension Bridges by Professor Melan. The German method of starting at the beginning and taking nothing for granted is followed. In the opening chapters a masterly exposition of the conditions of statical determinacy and indeterminacy is given, as also the general forms into which hinged and fixed arches may be resolved. The book deserves a place in the library of every practising engineer who has anything to do with structures of any kind, and will amply compensate him for all time devoted to the study of its pages."

DIAGRAMS FOR THE DESIGN OF REINFORCED CONCRETE STRUCTURES

By **G. F. Dodge**

Cloth, 15 1/2 x 12 1/2, 112 pages, 43 diagrams \$4.00

Founded on diagrams prepared by the author for his own use when employed as a designing engineer for a reinforcing company. No experience in mathematics required by those who do their designing from this book.

Table of Contents

Formulae and Discussion: Straight Line Variations of Stress; Slabs; Cinder Concrete; Rectangular Beams; T Beams; Compressive Reinforcement; Hooped Columns, Ultimate Loads; Hooped Columns, Working Loads; Parabolic Variation of Stress, Ultimate Loads; Slabs; Rectangular Beams.

Miscellaneous—Deflections; Impact; Weight and Volumes of Beams, Columns and Slabs, Reactions and Strengths of Steel Beams; Bending Moments of Beams and Channels in ft.-lbs.; Bending Moment and Shear Formulae; also contains numerous diagrams; Appendix.

CLARK BOOK CO., INC., 27 William Street, New York City

MILL BUILDINGS DESIGN AND CONSTRUCTION

With Chapters comparing the costs of steel, wood and concrete buildings, and on exporting steel buildings

By Henry Grattan Tyrrell, C. E., author of *Mill Building Construction, Concrete Bridges and Culverts, History of Bridge Engineering, Artistic Bridge Design, etc.*

Cloth, 6 x 9, 490 pages, 652 illustrations, with chapter comparing wood, steel and concrete buildings \$4.00

The final efficiency of an industrial plant depends not merely upon the proper design of structural members, but also upon a great variety of special problems which might be classified as the economics of design.

"Mill Buildings" thoroughly covers the latter as well as the former, in fact it is this thorough treatment of the economic feature which distinguishes the book from others on the same subject.

Chapter Headings

General Features and Requirements of Economic Design; Location and Site; Purpose and Arrangement; Number of Stories; Walls; Cost of Steel Buildings; Comparative Cost of Wood, Steel and Concrete Buildings; Roof Covering and Drainage; Lighting and Ventilating; Static Roof Loads; Floor Loads; Snow and Wind Loads; Crane and Miscellaneous Loads; Steel Framing; Wood Framing; Concrete Framing; Northern Light Roof Framing; Foundations and Anchorages; Wall Details; Ground Floors; Upper Floors; Metal Arch Floors; Roofs, Non-Waterproof; Roofings, Tile, Slate, Asbestos, Slate, Wood, Composition Roofing; Corrugated Iron; Sheet Metal Roofing; Cornices, Gutters and Downspouts; Ventilators, Glass, Skylights, Windows; Monitor Windows, Doors; Factory Foot Bridges; Paint, Painting; Painting Specifications for Structural Steel Work; Engineering Department; Estimating the Quantities; Estimating the Costs; Approximate Estimating Prices; The Drafting Office; Organization of Drafting Office; Drafting Office Practice; Cost of Structural Work Shop Drawings; Directions for Exporting Steel Buildings.

ARTISTIC BRIDGE DESIGN

By Henry Grattan Tyrrell, C. E., author of *Mill Building Construction, Concrete Bridges and Culverts, History of Bridge Engineering, and Mill Buildings.*

Cloth, 6 1/4 x 9 3/4, 290 pages, illustrated \$3.00

Long after the cost of a bridge is forgotten, its appearance stands for or against its designer, and this book is designed to help the engineer or architect who realizes this, to combine beauty, utility and economy in his work.

The work is divided as follows:

Subject.	Pages.
Introduction by Thomas Hastings, Importance of Bridges, Reasons and Standards for Art in Bridges, Causes for Lack of Art, and Special Features of Bridges	34
Principles of Design	15
Ordinary Steel Structures	6
Cantilever Bridges	6
Metal Arches	16
Suspension Bridges	10
Masonry Bridges	24
Illustrations and Descriptions	157

These last are taken from representative structures all over the world, covering the general classes mentioned above. The illustrations alone justify the book.

America has the reputation for having "the greatest number of bridges, and the ugliest." Mr. Tyrrell's work is an effort to reform the policy that has given us this record.

FIELD SYSTEM

By Frank B. Gilbreth

Handbook size and binding, 200 pages \$3.00

Mr. Gilbreth made the "Cost-plus-a-fixed-sum" contract famous. This "Field System" is the book of instructions issued to all his foremen, superintendents, time and material clerks, accounting departments, etc. Valuable rules for running a job.

CLARK BOOK CO., INC., 27 William Street, New York City

STEEL BRIDGE DESIGNING

By Melville B. Wells, C. E., Assoc. Prof. Bridge & Struc. Eng., Armour Inst. Technology

Cloth, 6 x 9 inches, 250 pages, 47 illustrations, 27 folding plates . . . \$2.50
A text book for engineering students and a reference work for designing offices.

The twenty-seven folding plates, which are reproductions of actual drawings taken from standard practice, make the book especially valuable.

Another valuable feature, especially for the draughting room, is the copy of the general specifications for steel railway bridges, adopted by the American Railway Engineering Association, elaborately cross indexed in this book.

Chapter Headings

Engineers' Work and Contracts, Bridge Manufacture; Rivets; The Design of a Roof Truss; Types and Details of Highway Bridges; Design of a Riveted Truss Highway Bridge; Types and Details of Railway Bridges; Design of a Plate Girder Railroad Bridge; Design of a Riveted Truss Railroad Bridge; A Pin Connected Bridge; Shop Drawings; Strength of Materials; Bibliography; Specifications.

CONCRETE CONSTRUCTION, METHODS AND COST

By H. P. Gillette, Consulting Engineer, and Charles S. Hill, Associate Editor of *Engineering and Contracting*

6 1/2 x 9 1/4, cloth, 690 pages \$5.00

Devoted to the economics of concrete for the builder of concrete structures. The authors are constantly in touch with the best and cheapest methods of concrete construction; Mr. Gillette, through his field work, and Mr. Hill, as editor of *Engineering and Contracting*.

CHAPTERS:—Methods and Cost of Selecting and Preparing Materials for Concrete; Theory and Practice of Proportioning Concrete; Making and Placing Concrete by Hand; Making and Placing Concrete by Machine; Depositing Concrete Under Water and of Subaqueous Grouting; Making and Using Rubble and Asphaltic Concrete; Laying Concrete in Freezing Weather; Finishing Concrete Surfaces; Form Construction; Concrete Pile and Pier Construction; Heavy Concrete Work in Fortifications, Locks, Dams, Breakwaters and Piers; Constructing Bridge Piers and Abutments; Constructing Retaining Walls; Constructing Concrete Foundations for Pavement; Constructing Sidewalks, Pavements, Curbs and Gutters; Lining Tunnels and Subways; Constructing Arch and Girder Bridges; Culvert Construction; Reinforced Concrete Building Construction; Building Construction of Separately Molded Members; Aqueduct and Sewer Construction; Constructing Reservoirs and Tanks; Constructing Ornamental Work; Miscellaneous Methods and Costs; Waterproofing Concrete Structures.

ENGINEERS' POCKETBOOK OF REINFORCED CONCRETE

By E. Lee Heidenreich, Mem. Am. Soc. Test. Materials; M. W. S. E.; Mem. Am. Inst. Min. Eng.

Flexible leather, 374 pages, 4 1/2 x 6 3/4 inches, 80 tables, illustrated. . . \$3.00

Here is the "Trautwine" of reinforced concrete, the product of the author's 15 years' experience in the design and construction of reinforced concrete.

The tables and formulæ were designed particularly to save time in the draughting room, not simply inserted as detached bits of information.

The formulæ are not simply stated, but developed and illustrated with examples as well, so that the beginner or "rusty" mind can grasp them readily.

Chapter Headings

Materials and Machines Used in Concrete Construction; Design and Construction of Buildings; Design and Construction of Bridges; Abutments and Retaining Walls; Culverts, Conduits, Sewers, Pipes and Dams; Tanks, Reservoirs, Bins and Grain Elevators; Chimneys. Miscellaneous Data.

Engineering News: "Mr. Heidenreich's pocket-book is nearer the ideal than any on the same subject heretofore published."

CLARK BOOK CO., INC., 27 William Street, New York City

WALKER'S BUILDING ESTIMATORS' REFERENCE WORK

By Frank R. Walker, a Contractor

Flexible leather, handbook size, 600 pages\$10.00

This is a practical and thoroughly reliable reference book for contractors and estimators engaged in estimating the cost of and in constructing all classes of modern buildings.

It gives the actual labor costs and methods employed in the erection of some of our present day structures, together with all the necessary materials, prices and labor quantities entering into the costs of all classes of buildings.

Contents

General Conditions and Overhead Expense; Wrecking and Excavating; Caissons; Lagging and Concrete; Wood and Concrete Piles; Concrete for Footings and Foundations; Water and Damp Proofing; Concrete Floors and Pavements; Reinforced Concrete Construction; Brick Masonry; Rubble Work, Cut Stone, Granite and Architectural Terra Cotta; Hollow Tile Fireproofing; Rough Carpentry; Timber Framing, Lumber, Flooring, etc.; Mill Work and Interior Finish; Plastering; Fire Retarding Doors and Windows; Sheet Metal Work, etc.; Roofing, Slate, Tile, Composition, etc.; Exterior and Interior Models, Slate or Scagliola; Interior Tiling, Floors, Wainscoting, Mantels, etc.; Glass and Glazing; Painting and Varnishing; Structural Iron and Steel; Miscellaneous and Ornamental Iron, Brass and Bronze; Miscellaneous Building Specialties, Vault Doors, Prismatic Sidewalk Lights, Blackboards, etc.; Rough and Finish Hardware; Plumbing, Sewerage and Gas Fitting; Steam and Hot Water Heating, Electric Wiring.

BRICKLAYING SYSTEM

By Frank B. Gilbreth, Mem. Am. Soc. M. E.

Cloth, 6 x 9 inches, 330 pages, 167 illustrations, 73 bond charts . . . \$3.00

This book was written by one of the largest general contractors in New York, for his own foremen and superintendents, but is vastly more than a mere rule book.

It is the application of the new movement for more science in management, to bricklaying in particular, but its principles are applicable to the entire building and engineering industry.

Brick costs must be reduced if brick is to hold its place as a building material in the face of concrete's competition. Gilbreth's "Bricklaying System" is a great help in this direction.

There is no contractor doing brick work who is not vitally interested in the reduction of costs, and "Bricklaying System" can help him, unless he already knows all there is to be known.

Chapter Headings

Training Apprentices; Methods of Management; Methods of Construction; Routing of Material; Scaffold, The Gilbreth Scaffold, Hod Type; the Gilbreth Scaffold, Packet Type; The Gilbreth Packet System; Method of Building Tall Chimneys; Mortar; Bricks; Bricklayers' Tools, etc.; Lines, Plumbs and Poles; Motion Study; Methods of Laying Brick Under Special Conditions; Finishing, Jointing and Pointing; Arches and Chimney Breasts; Tearing Down, Cutting Out and Patching Brickwork; Bond.

INSPECTION OF CONCRETE CONSTRUCTION

By Jerome Cochran

Cloth, 6 x 9, 595 pages, illustrated\$4.00

Covers over 200 different special subjects under concrete, elaborately indexed for quick reference. An encyclopedia for the inspector, engineer, superintendent or foreman on concrete work.

Chapter Headings

Inspection of Hydraulic Cement; Inspection of Sand, Stone, etc., Inspection of Proportioning and Mixing; Inspection of Forms, Molds, Centering, etc.; Inspection of Steel Reinforcement; Inspection of Concreting; Inspection of Surface Finishes; Inspection of Waterproofing; Inspection of Sidewalks, Curbs and Pavements; Inspection of Ornamental Work, Blocks, etc.; Inspection of Molding and Driving Concrete Piles; Definition of Terms, List of Authorities, Index.

CLARK BOOK CO., INC., 27 William Street, New York City

CONCRETE AND REINFORCED CONCRETE CONSTRUCTION

By Homer A. Reid, Assoc. M. Am. Soc. C. E. Asst. Eng., Bureau of Bldgs., N. Y.

Cloth, 6 x 9 inches, 906 pages, 70 tables, 715 illustrations \$5.00
A book of almost a thousand pages on concrete design and construction.

Contents

Historical Use and Development of Cement and Concrete; Classification and Manufacture of Cement; Properties of Cement and Methods of Testing; Sand, Broken Stone, and Gravel; Proportioning Concrete; Mixing Concrete; Placing Concrete; Cost of Concrete; Finishing Concrete Surfaces; General Physical Properties; The General Elastic Properties of Concrete; Physical Properties of Reinforcing Metals; Principles and Disposition of Reinforcement; Mechanical Bond; Styles of Slab Reinforcement; Styles of Beam Reinforcement; Curved Pieces Strained in Flexure; Columns, Walls and Pipes; General Phenomena of Flexure; Theory of Beams; Various Beam Theories; Theory of Columns; Foundations; General Building Construction; Practical Construction; Retaining Walls; Dams; Conduits and Sewers; Tank and Reservoir Construction; Chimneys, Tunnels, Subways, Railroad Ties, Fence Posts, Piers and Wharves; Concrete in Bridge Construction; Arch Bridge Centers and Methods of Construction; Bridge Floors; Bridges, Piers and Abutments; Concrete Building Blocks.

THEORY AND DESIGN OF CONCRETE ARCHES

By Arvid Reuter Dahl

Cloth, 6 x 9, 132 pages \$2.00

Every principle of concrete arch design is explained thoroughly — there are no missing steps in the mathematics.

Engineering News says: "For the student who wishes to get in one book the whole theory, to its minutest details, of the reinforced concrete arch, and who is not over-awed by a succession of formula-filled pages, we can commend this book. For any beginner in the designs of such bridges, the latter part will prove most useful."

PRACTICAL CEMENT TESTING

By W. Purves Taylor

Cloth, 6 x 9 inches, 330 pages, 58 tables, 142 illustrations \$3.00

Adopted by University of Pennsylvania and other technical schools. Especially valuable in the instructions on interpreting results of tests.

Contents

Classification and Statistics, Composition and Constitution, Manufacture, Inspection and Sampling; The Testing of Cement; Specific Gravity; Fineness, Time of Setting; Tensile Strength; Soundness; Chemical Analysis; Special Tests; Approximate Tests; Practical Operation; Other Varieties of Cement; Specifications; Appendices Giving A. S. C. E., N. Y. Section, Society for Chemical Industry, A. S. T. M., U. S. Army, British and Canadian Methods of Testing and Specifications.

CIVIL ENGINEERS' POCKET BOOK

By Albert I. Frye

Handbook size, leather, 1600 pages, illustrated \$5.00

This is the encyclopedia of civil engineering, as may be seen from the table of contents:

Mathematics; Mechanics; Stresses in Structures; Materials; Explosives; Preservatives; Lumber and Lumbering; Building Stones and Cements; Quarrying; Stone Cutting; Masonry; Stereotomy; Weights of Materials; Strength of Materials; Properties of Plane Surfaces; Properties and Tables of Steel Shapes; Beams and Girders; Columns; Structural Details; Metal Gages; Cordage; Wire and Cables; Pipes and Tubes; Railway Bridges; Electric Railway Bridges; Highway Bridges; Cantilever Bridges; Movable Bridges; Suspension Bridges; Arches; Trestles; Roofs; Buildings; Retaining Walls; Dams; Foundations; Wharves, Piers and Docks; Breakwaters; Jetties; Earthwork; Rock Excavations; Dredging; Tunneling; Surveying; Mapping and Leveling, Railroads; Highways; Hydrostatics; Hydraulics; Water Supply; Water Works; Sanitation; Irrigation; Waterways; Water Power; Steam and Gas Power; Electric Power and Lighting; Miscellaneous Data and Illustrations, all completely indexed, a total of 1600 pages.

CLARK BOOK CO., INC., 27 William Street, New York City

CONCRETE BRIDGES AND CULVERTS

By Henry Grattan Tyrrell, C. E.

Flexible leather, 4½ x 6¾ (handbook size), 272 pages\$3.00

A handbook on the design and construction of concrete bridges, in which the simplest and easiest formulae have been used, and only those actually necessary in the design of these structures.

Contents

Plain Concrete Arch Bridges; Reinforced Concrete Arch Bridges; Highway Beam Bridges; Concrete Culverts and Trestles.

MILITARY PREPAREDNESS AND THE ENGINEER

By Capt. E. F. Robinson, Corps of Engineers, N. G. N. Y.

Handbook size and binding, 224 pages, illustrated\$1.50

Chapters

How to Obtain Military Training; The National Guard; Military Organization; Administration; Engineer Troops in the Field; Fire Action; Field Fortifications; Obstacles; Siege Works; Demolitions; Military Bridges; Topographical Sketching; Needs of the Engineers in War; Bibliography; Reading Matter for Civilian Engineers; Property Carried by a Company of Engineers in the Field.

BACKBONE OF PERSPECTIVE

By T. U. Taylor

Cloth, 4½ x 7 inches, 56 pages, illustrated\$1.00

Chapter Headings

Primary Methods; Vanishing Point Method; Axometric Projections; Shades and Shadows.

LAW OF CONTRACT

By Alexander Haring

Cloth, 6 x 9, 510 pages\$4.00

Engineers and contractors, with the guidance of this book, may save themselves disastrous losses by litigation or legal fees.

The rules of law in each chapter are illustrated by cases from practice, and opinions from cases of engineering litigations. The chapters are: The Contract; Its Inherent Elements; Its Formation; Parties Affected; Its Interpretation; Its Discharge.

GRAPHIC STATICS

By Charles W. Malcolm, C. E., Asst. Prof. Structural Engineering, University of Ill.; Assoc. Mem. Am. Soc. C. E., and Soc. for Promotion of Engineering Education

Cloth, 6 x 9 inches, 330 pages, 155 drawings\$3.00

A book for the designer and draughtsman, anyone in structural work, in fact, who desires a knowledge of the principles back of structural design.

Two criticisms applicable to many text books on graphic statics do not apply to this, that is, every construction given here is so fully developed that the principle behind it is clearly seen, and second, elaborate solutions which have little or no practical application have not been allowed to pad the book and confuse the student.

The four parts of the text are:

I, General Principles; II, Framed Structures, Roof Trusses; III, Beams; IV, Bridges.

LAND DRAINAGE

By J. L. Parsons Assoc. Mem. W. S. E.

Cloth, 6 x 9, 195 pages, 32 figures\$1.50

Contents

Preliminary Drainage Surveys; The Design of Tile Drains; Tile Drain Outlet Walls and Inlets; Design and Maintenance of Open Drains; Plans, Reports and Records; The Estimate of Costs of Drainage Systems; The Preparation and Enforcement of Drainage Specifications; The Division of Costs of Drainage Systems; The Quality and Inspection of Drain Tile.

Twenty-two tables and 36 illustrations.

Engineering Record: "... written with painstaking thoroughness and with a marked effort to make it clear to the non-technical mind. It deals with all the problems likely to be met with on land drainage projects from the preliminary survey to the contractors' financing operations."

CLARK BOOK CO., INC., 27 William Street, New York City









Stanford University Libraries



3 6105 023 897 304

EARTH SCIENCES LIBRARY

BRANNER EARTH SCIENCES LIBRARY

